



FCC TEST REPORT

For

Huizhou Tongyinhai Precision Electronics Co., Ltd.

Magnetic wireless charging power bank A10

Test Model: TYH-60099

Prepared for : Huizhou Tongyinhai Precision Electronics Co., Ltd.
Address : 27 Xingwang Street, Gaobao Road, Lilin Town, Huizhou, Guangdong, China

Prepared by : Shenzhen LCS Compliance Testing Laboratory Ltd.
Address : 101, 201 Bldg A & 301 Bldg C, Juji Industrial Park Yabianxueziwei, Shajing Street, Baoan District, Shenzhen, 518000, China

Tel : (+86)755-82591330
Fax : (+86)755-82591332
Web : www.LCS-cert.com
Mail : webmaster@LCS-cert.com

Date of receipt of test sample : December 24, 2021
Number of tested samples : 2
Serial number : 211223032A-1, 211223032A-2
Date of Test : December 24, 2021 ~ January 04, 2022
Date of Report : January 05, 2022



**FCC TEST REPORT
FCC CFR 47 PART 15C**

Report Reference No. : **LCS211223032AEA**

Date Of Issue : January 05, 2022

Testing Laboratory Name..... : **Shenzhen LCS Compliance Testing Laboratory Ltd.**

Address : 101, 201 Bldg A & 301 Bldg C, Juji Industrial Park
Yabianxueziwei, Shajing Street, Baoan District, Shenzhen,
518000, China

Testing Location/ Procedure : Full application of Harmonised standards
Partial application of Harmonised standards
Other standard testing method

Applicant's Name : **Huizhou Tongyin Hai Precision Electronics Co., Ltd.**

Address : 27 Xingwang Street, Gaobao Road, Lilin Town, Huizhou,
Guangdong, China

Test Specification

Standard..... : FCC CFR 47 PART 15C

Test Report Form No. : LCSEMC-1.0

TRF Originator..... : Shenzhen LCS Compliance Testing Laboratory Ltd.

Master TRF : Dated 2011-03

Shenzhen LCS Compliance Testing Laboratory Ltd. All rights reserved.

This publication may be reproduced in whole or in part for non-commercial purposes as long as the Shenzhen LCS Compliance Testing Laboratory Ltd. is acknowledged as copyright owner and source of the material. Shenzhen LCS Compliance Testing Laboratory Ltd. takes no responsibility for and will not assume liability for damages resulting from the reader's interpretation of the reproduced material due to its placement and context.

Test Item Description..... : **Magnetic wireless charging power bank A10**

Trade Mark : N/A

Test Model..... : TYH-60099

Power Supply : USB-C Input:5V $\overline{=}$ 3A/9V $\overline{=}$ 2A/12V $\overline{=}$ 1.5A
USB-C Output:5V $\overline{=}$ 3A/9V $\overline{=}$ 2A/12V $\overline{=}$ 1.5A
Wireless charger 5W/7.5W/10W/15W Max
DC 3.8V by Rechargeable Li-ion Battery, 10000mAh

Result : **Positive**

Compiled by:

Kevin Huang

Kevin Huang/ Administrator

Supervised by:

Jin Wang

Jin Wang/ Technique principal

Approved by:

Gavin Liang

Gavin Liang/ Manager



FCC TEST REPORT

Test Report No. : LCS211223032AEA	<u>January 05, 2022</u> Date of issue
--	--

Test Model.....	: TYH-60099
EUT.....	: Magnetic wireless charging power bank A10
Applicant.....	: Huizhou Tongyinhai Precision Electronics Co., Ltd.
Address.....	: 27 Xingwang Street, Gaobao Road, Lilin Town, Huizhou, Guangdong, China
Telephone.....	: /
Fax.....	: /
Manufacturer.....	: Huizhou Tongyinhai Precision Electronics Co., Ltd.
Address.....	: 27 Xingwang Street, Gaobao Road, Lilin Town, Huizhou, Guangdong, China
Telephone.....	: /
Fax.....	: /
Factory.....	: Huizhou Tongyinhai Precision Electronics Co., Ltd.
Address.....	: 27 Xingwang Street, Gaobao Road, Lilin Town, Huizhou, Guangdong, China
Telephone.....	: /
Fax.....	: /

Test Result	Positive
--------------------	-----------------

The test report merely corresponds to the test sample.
It is not permitted to copy extracts of these test result without the written permission of the test laboratory.



Revision History

Revision	Issue Date	Revisions	Revised By
000	January 05, 2022	Initial Issue	Gavin Liang



TABLE OF CONTENTS

1. GENERAL INFORMATION	6
1.1 Description of Device (EUT)	6
1.2 Support equipment List	6
1.3 External I/O Cable	6
1.4 Description of Test Facility	6
1.5 Statement of the Measurement Uncertainty	7
1.6 Measurement Uncertainty	7
1.7 Description of Test Modes	7
2. TEST METHODOLOGY	8
2.1 EUT Configuration	8
2.2 EUT Exercise	8
2.3 General Test Procedures	8
2.3.1 Conducted Emissions	8
2.3.2 Radiated Emissions	8
3. SYSTEM TEST CONFIGURATION	9
3.1 Justification	9
3.2 EUT Exercise Software	9
3.3 Special Accessories	9
3.4 Block Diagram/Schematics	9
3.5 Equipment Modifications	9
3.6 Test Setup	9
4. SUMMARY OF TEST EQUIPMENT	10
5. SUMMARY OF TEST RESULT	11
6. POWER LINE CONDUCTED MEASUREMENT	12
7. RADIATED EMISSION MEASUREMENT	15
7.1. Block Diagram of Test Setup	15
7.2. Radiated Emission Limit	16
7.3. EUT Configuration on Measurement	16
7.4. Operating Condition of EUT	16
7.5. Measuring Setting	17
7.6. Test Procedure	17
7.7. Test Results	18
9. PHOTOGRAPHS OF TEST SETUP	22
10. EXTERNAL PHOTOGRAPHS OF THE EUT	22
11. INTERNAL PHOTOGRAPHS OF THE EUT	22



1. GENERAL INFORMATION

1.1 Description of Device (EUT)

EUT : Magnetic wireless charging power bank A10

Test Model : TYH-60099

Power Supply : USB-C Input:5V \leq 3A/9V \leq 2A/12V \leq 1.5A
USB-C Output:5V \leq 3A/9V \leq 2A/12V \leq 1.5A
Wireless charger 5W/7.5W/10W/15W Max
DC 3.8V by Rechargeable Li-ion Battery, 10000mAh

Hardware Version : /

Software Version : /

Wireless Charging :

Operating Frequency : 111.0~205.0KHz

Modulation Type : Continuous Wave

Antenna Type : Coil Antenna

1.2 Support equipment List

Manufacturer	Description	Model	Serial Number	Certificate
OPPO	Adapter	OP52KAUH	--	FCC
Huawei	Mobile phone	FRD-AL10	FRD-AL10C00B373	FCC

Note: The adapter and mobile phone are supplied by lab and only use tested.

1.3 External I/O Cable

I/O Port Description	Quantity	Cable
Type-C Port	1	N/A

1.4 Description of Test Facility

NVLAP Accreditation Code is 600167-0.
FCC Designation Number is CN5024
CAB identifier is CN0071.
CNAS Registration Number is L4595.
Test Firm Registration Number: 254912

The 3m-Semi anechoic test site fulfils CISPR 16-1-4 according to ANSI C63.4:2014 and CISPR 16-1-4:2010 SVSWR requirement for radiated emission above 1GHz.



1.5 Statement of the Measurement Uncertainty

The data and results referenced in this document are true and accurate. The reader is cautioned that there may be errors within the calibration limits of the equipment and facilities. The measurement uncertainty was calculated for all measurements listed in this test report acc. To CISPR 16 – 4 “Specification for radio disturbance and immunity measuring apparatus and methods – Part 4: Uncertainty in EMC Measurements” and is documented in the LCS quality system acc. To DIN EN ISO/IEC 17025. Furthermore, component and process variability of devices similar to that tested may result in additional deviation. The manufacturer has the sole responsibility of continued compliance of the device.

1.6 Measurement Uncertainty

Test Item	Frequency Range	Uncertainty	Note
Radiation Uncertainty	9KHz~30MHz	3.10dB	(1)
	30MHz~200MHz	2.96dB	(1)
	200MHz~1000MHz	3.10dB	(1)
	1GHz~26.5GHz	3.80dB	(1)
	26.5GHz~40GHz	3.90dB	(1)
Conduction Uncertainty	150kHz~30MHz	1.63dB	(1)
Power disturbance	30MHz~300MHz	1.60dB	(1)

(1). This uncertainty represents an expanded uncertainty expressed at approximately the 95% confidence level using a coverage factor of k=2.

1.7 Description of Test Modes

Equipment under test was operated during the measurement under the following conditions:

Charging and communication mode

Modulation Type: CW (Continuous Wave)

Test Modes		
Mode 1	AC/DC Adapter (5V/3A) + EUT + Mobile Phone (Battery Status: <1%)	Record
Mode 2	AC/DC Adapter (5V/3A) + EUT + Mobile Phone (Battery Status: <50%)	Pre-tested
Mode 3	AC/DC Adapter (5V/3A) + EUT + Mobile Phone (Battery Status: 100%)	Pre-tested
Mode 4	AC/DC Adapter (9V/2A) + EUT + Mobile Phone (Battery Status: <1%)	Pre-tested
Mode 5	AC/DC Adapter (9V/2A) + EUT + Mobile Phone (Battery Status: <50%)	Pre-tested
Mode 6	AC/DC Adapter (9V/2A) + EUT + Mobile Phone (Battery Status: 100%)	Pre-tested
Mode 7	AC/DC Adapter (12V/1.5A) + EUT + Mobile Phone (Battery Status: <1%)	Pre-tested
Mode 8	AC/DC Adapter (12V/1.5A) + EUT + Mobile Phone (Battery Status: <50%)	Pre-tested
Mode 9	AC/DC Adapter (12V/1.5A) + EUT + Mobile Phone (Battery Status: 100%)	Pre-tested

Note: All test modes were pre-tested, but we only recorded the worst case in this report.

For AC conducted emission, pre-test at both AC 120V/60Hz and AC 240V/50Hz, recorded worst case;

For AC conducted emission, pre-test at both AC charge from power adapter modes, recorded worst case.



2. TEST METHODOLOGY

The tests documented in this report were performed in accordance with ANSI C63.10-2013, FCC CFR PART 15C 15.207 and DA 00-705.

2.1 EUT Configuration

The EUT configuration for testing is installed on RF field strength measurement to meet the Commissions requirement and operating in a manner that intends to maximize its emission characteristics in a continuous normal application.

2.2 EUT Exercise

The EUT was operated in the normal operating mode for Hopping Numbers and Dwell Time test and a continuous transmits mode for other tests.

According to its specifications, the EUT must comply with the requirements of the Section 15.207 under the FCC Rules Part 15 Subpart C.

2.3 General Test Procedures

2.3.1 Conducted Emissions

The EUT is placed on the turntable, which is 0.8 m above ground plane. According to the requirements in Section 6.2.1 of ANSI C63.10-2013 Conducted emissions from the EUT measured in the frequency range between 0.15 MHz and 30MHz using Quasi-peak and average detector modes.

2.3.2 Radiated Emissions

The EUT is placed on a turn table, which is 0.8 m above ground plane below 1GHz and 1.5 m above ground plane above 1GHz. The turntable shall rotate 360 degrees to determine the position of maximum emission level. EUT is set 3m away from the receiving antenna, which varied from 1m to 4m to find out the highest emission. And also, each emission was to be maximized by changing the polarization of receiving antenna both horizontal and vertical. In order to find out the maximum emissions, exploratory radiated emission measurements were made according to the requirements in Section 6.3 of ANSI C63.10-2013



3. SYSTEM TEST CONFIGURATION

3.1 Justification

The system was configured for testing in a normal condition.

3.2 EUT Exercise Software

N/A.

3.3 Special Accessories

N/A.

3.4 Block Diagram/Schematics

Please refer to the related document.

3.5 Equipment Modifications

Shenzhen LCS Compliance Testing Laboratory Ltd. has not done any modification on the EUT.

3.6 Test Setup

Please refer to the test setup photo.



4. SUMMARY OF TEST EQUIPMENT

Item	Equipment	Manufacturer	Model No.	Serial No.	Cal Date	Due Date
1	MXA Signal Analyzer	Agilent	N9020A	MY49100040	2021-06-17	2022-06-16
2	SPECTRUM ANALYZER	R&S	FSP40	100503	2021-11-16	2022-11-15
3	3m Semi Anechoic Chamber	SIDT FRANKONIA	SAC-3M	03CH03-HY	2021-09-25	2022-09-24
4	Positioning Controller	MF	MF-7082	/	2021-06-21	2022-06-20
5	EMI Test Software	EZ	EZ-EMC	/	N/A	N/A
6	EMI Test Receiver	R&S	ESR 7	101181	2021-06-21	2022-06-20
7	Active Loop Antenna	SCHWARZBECK	FMZB 1519B	00005	2021-06-30	2024-07-01
8	By-log Antenna	SCHWARZBECK	VULB9163	9163-470	2021-06-30	2024-07-01
9	Horn Antenna	SCHWARZBECK	BBHA 9120D	9120D-1925	2021-06-30	2024-07-01
10	RF Cable-R03m	Jye Bao	RG142	CB021	2021-06-21	2022-06-20
11	RF Cable-HIGH	SUHNER	SUCOFLEX 106	03CH03-HY	2021-06-21	2022-06-20
12	EMI Test Receiver	R&S	ESPI	101840	2021-06-21	2022-06-20
13	Artificial Mains	R&S	ENV216	101288	2021-06-21	2022-06-20
14	10dB Attenuator	SCHWARZBECK	MTS-IMP-136	261115-001-0032	2021-06-21	2022-06-20
15	Broadband Pre-amplifier	SCHWARZBECK	BBV9745	9719-025	2021-06-21	2022-06-20



5. SUMMARY OF TEST RESULT

FCC Rules	Description of Test	Test Sample	Result
§15.207(a)	AC Conducted Emissions	Sample 1	Compliant
§15.209	Radiated Spurious Emissions	Sample 1	Compliant

Remark: The measurement uncertainty is not included in the test result.

N/A – Not Applicable!!!

6. POWER LINE CONDUCTED MEASUREMENT

6.1. Block Diagram of Test Setup

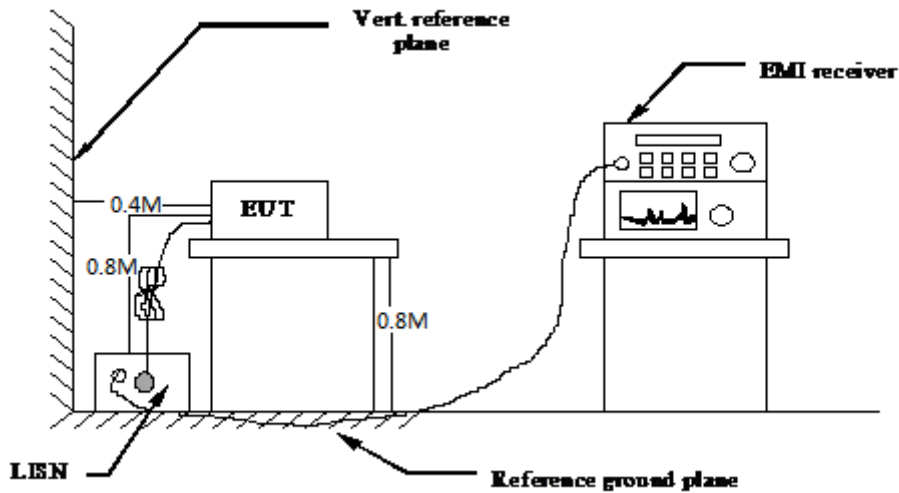

6.2. Standard Applicable

According to §15.207: For all the consumer devices which is designed to be connected to the public utility (AC) power line, the radio frequency voltage that is conducted back onto the AC power line on any frequency or frequencies within the band 150 kHz to 30 MHz shall not exceed 250 microvolts (The limit decreases linearly with the logarithm of the frequency in the range 0.15 MHz to 0.50 MHz). The limits at specific frequency range are listed as follows:

Frequency Range (MHz)	Limits (dB μ V)	
	Quasi-peak	Average
0.15 to 0.50	66 to 56	56 to 46
0.50 to 5	56	46
5 to 30	60	50

* Decreasing linearly with the logarithm of the frequency

6.3 Test Results

PASS

The test data please refer to following page.

Temperature	22.5°C	Humidity	53.7%
Test Engineer	Monkey Li	Configurations	Transmit



AC Power Line Conducted Emission (Power input to adapter @ AC 120V/60Hz (Worst Case))

Line

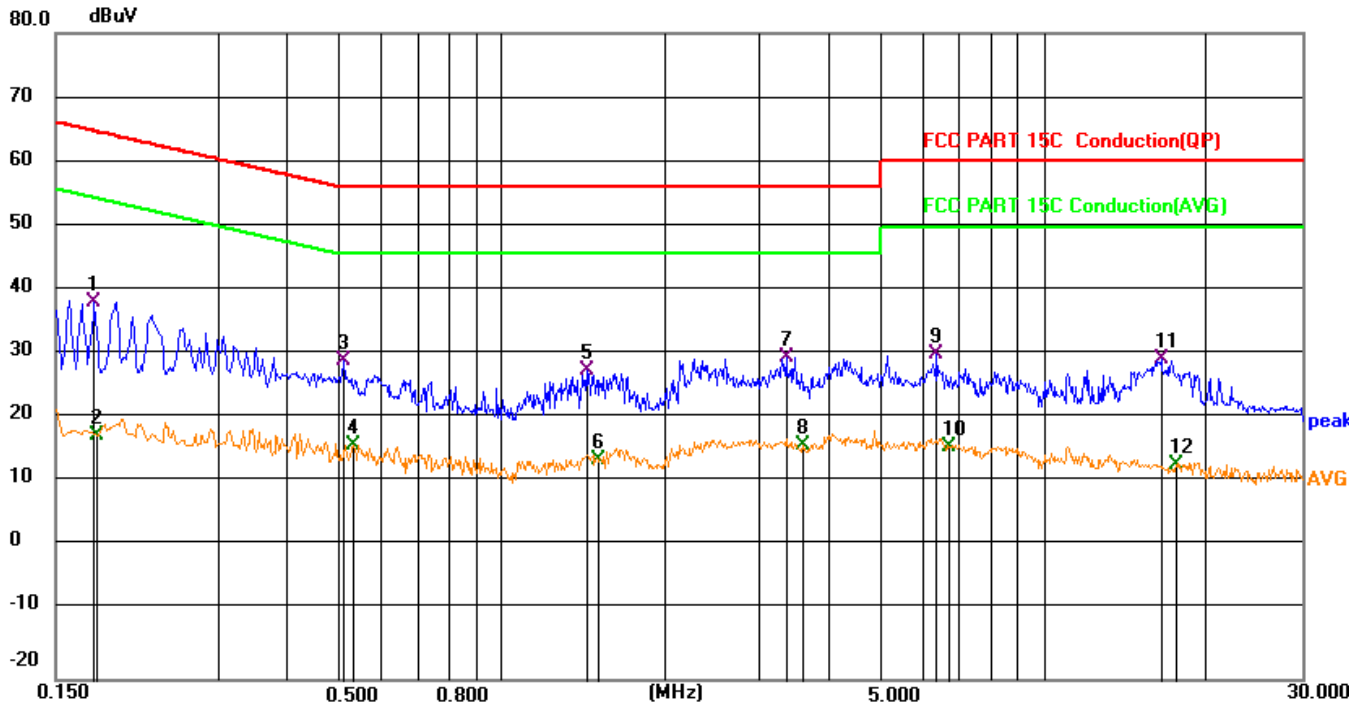

No.	Frequency (MHz)	Reading (dBuV)	Correct (dB)	Result (dBuV)	Limit (dBuV)	Margin (dB)	Remark
1	0.1771	18.57	19.76	38.33	64.62	-26.29	QP
2	0.1786	-1.83	19.76	17.93	54.55	-36.62	AVG
3	0.5100	9.55	19.77	29.32	56.00	-26.68	QP
4	0.5323	-3.54	19.77	16.23	46.00	-29.77	AVG
5	1.4370	8.00	19.80	27.80	56.00	-28.20	QP
6	1.5088	-5.80	19.81	14.01	46.00	-31.99	AVG
7	3.3496	9.99	19.87	29.86	56.00	-26.14	QP
8	3.5971	-3.54	19.88	16.34	46.00	-29.66	AVG
9	6.3555	10.46	19.96	30.42	60.00	-29.58	QP
10	6.7244	-3.86	19.97	16.11	50.00	-33.89	AVG
11	16.5614	8.99	20.65	29.64	60.00	-30.36	QP
12	17.6100	-7.55	20.75	13.20	50.00	-36.80	AVG



Neutral

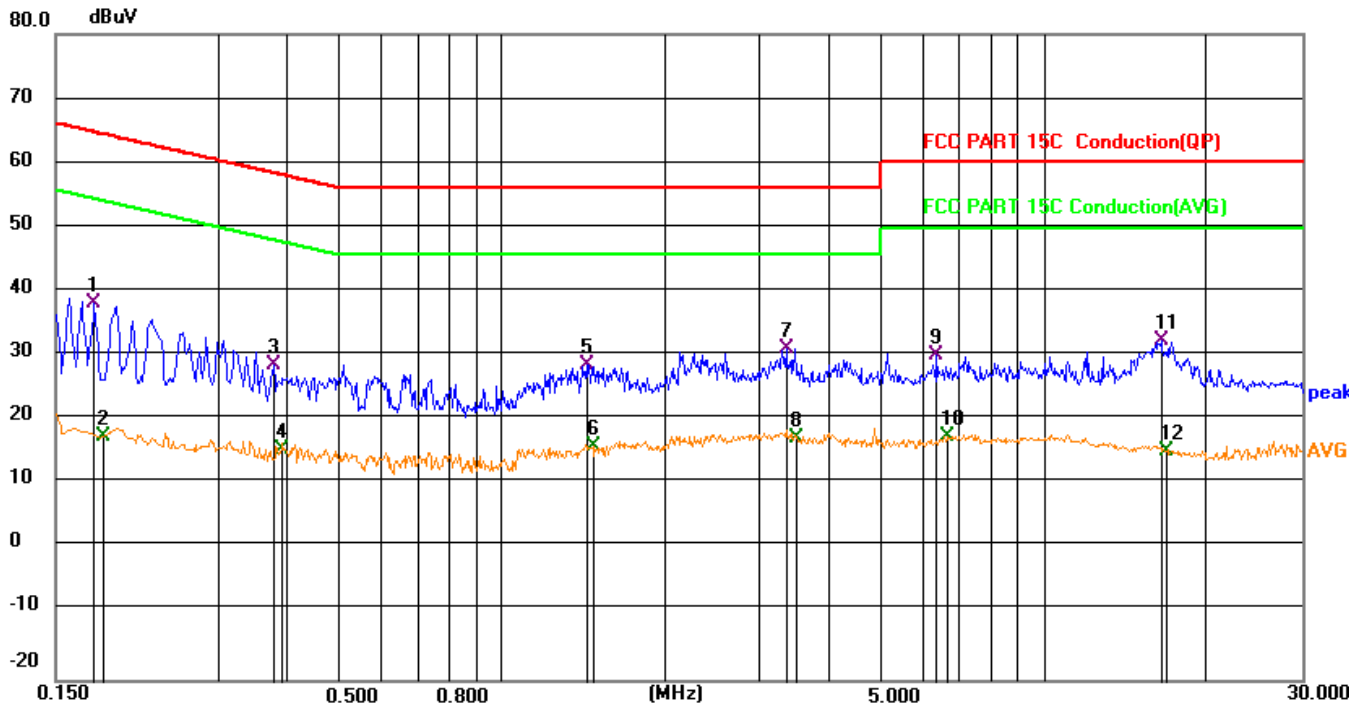

No.	Frequency (MHz)	Reading (dBuV)	Correct (dB)	Result (dBuV)	Limit (dBuV)	Margin (dB)	Remark
1	0.1771	18.57	19.76	38.33	64.62	-26.29	QP
2	0.1833	-1.94	19.76	17.82	54.33	-36.51	AVG
3	0.3795	9.10	19.76	28.86	58.29	-29.43	QP
4	0.3930	-3.88	19.76	15.88	48.00	-32.12	AVG
5	1.4370	9.00	19.80	28.80	56.00	-27.20	QP
6	1.4730	-3.53	19.80	16.27	46.00	-29.73	AVG
7	3.3496	11.49	19.87	31.36	56.00	-24.64	QP
8	3.5026	-2.21	19.87	17.66	46.00	-28.34	AVG
9	6.3555	10.46	19.96	30.42	60.00	-29.58	QP
10	6.6570	-2.25	19.96	17.71	50.00	-32.29	AVG
11	16.5615	11.99	20.65	32.64	60.00	-27.36	QP
12	16.8856	-5.08	20.69	15.61	50.00	-34.39	AVG

***Note: Pre-scan all modes and recorded the worst case results in this report.
Margin=Reading level + Correct - Limit

7. RADIATED EMISSION MEASUREMENT

7.1. Block Diagram of Test Setup

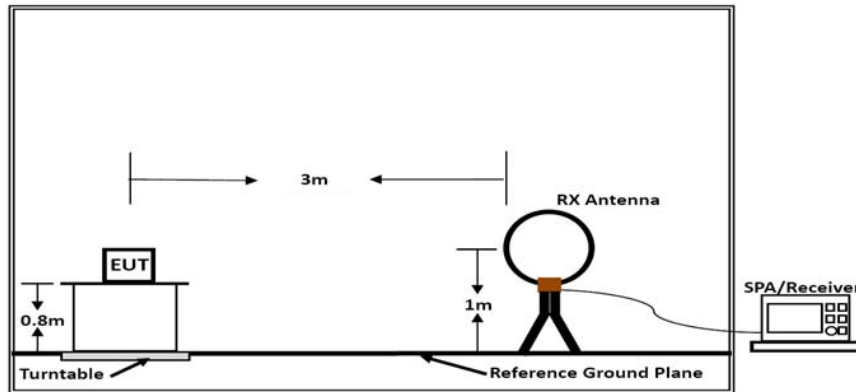

Below 30MHz

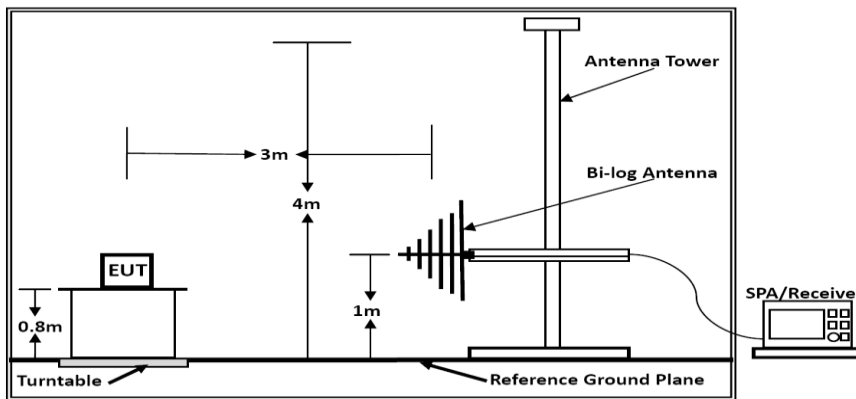

Below 1GHz

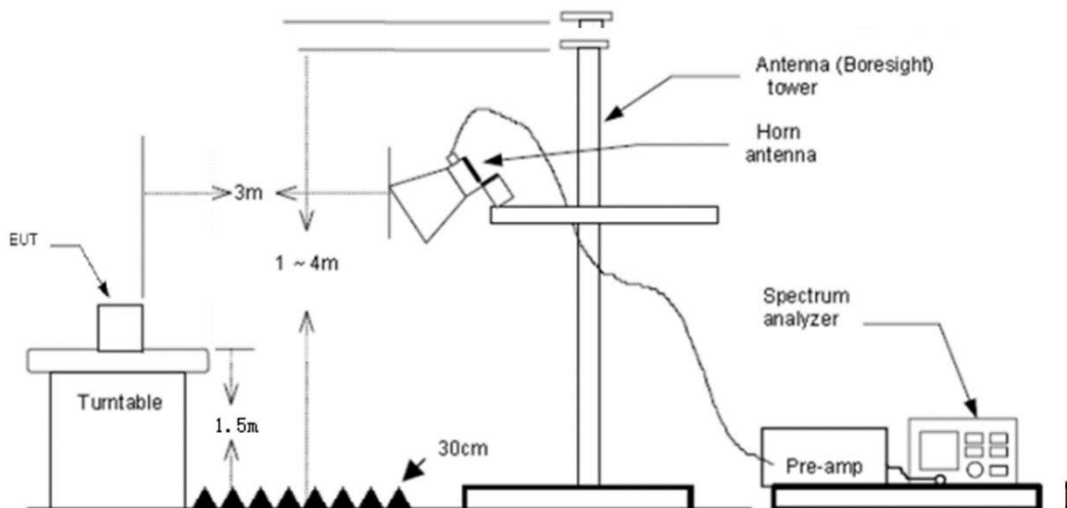



7.2. Radiated Emission Limit

15.205 (a) Except as shown in paragraph (d) of this section, only spurious emissions are permitted in any of the frequency bands listed below:

MHz	MHz	MHz	GHz
0.090-0.110	16.42-16.423	399.9-410	4.5-5.15
\1\ 0.495-0.505	16.69475-16.69525	608-614	5.35-5.46
2.1735-2.1905	16.80425-16.80475	960-1240	7.25-7.75
4.125-4.128	25.5-25.67	1300-1427	8.025-8.5
4.17725-4.17775	37.5-38.25	1435-1626	9.0-9.2
4.20725-4.20775	73-74.6	1645.5-1646.5	9.3-9.5
6.215-6.218	74.8-75.2	1660-1710	10.6-12.7
6.26775-6.26825	108-121.94	1718.8-1722.2	13.25-13.4
6.31175-6.31225	123-138	2200-2300	14.47-14.5
8.291-8.294	149.9-150.05	2310-2390	15.35-16.2
8.362-8.366	156.52475-156.52525	2483.5-2500	17.7-21.4
8.37625-8.38675	156.7-156.9	2690-2900	22.01-23.12
8.41425-8.41475	162.0125-167.17	3260-3267	23.6-24.0
12.29-12.293.	167.72-173.2	3332-3339	31.2-31.8
12.51975-12.52025	240-285	3345.8-3358	36.43-36.5
12.57675-12.57725	322-335.4	3600-4400	(2\)
13.36-13.41			

\1\ Until February 1, 1999, this restricted band shall be 0.490-0.510 MHz.

\2\ Above 38.6

According to §15.247 (d): 20dBc in any 100 kHz bandwidth outside the operating frequency band. In case the emission fall within the restricted band specified on 15.205(a), then the 15.209(a) limit in the table below has to be followed.

Frequencies (MHz)	Field Strength (microvolts/meter)	Measurement Distance (meters)
0.009~0.490	2400/F(KHz)	300
0.490~1.705	24000/F(KHz)	30
1.705~30.0	30	30
30~88	100	3
88~216	150	3
216~960	200	3
Above 960	500	3

7.3. EUT Configuration on Measurement

The following equipment are installed on Radiated Emission Measurement to meet the commission requirements and operating regulations in a manner which tends to maximize its emission characteristics in normal application.

7.4. Operating Condition of EUT

- (1) Setup the EUT as shown in Section 7.1.
- (2) Let the EUT work in worst test mode1 and measure it.



7.5. Measuring Setting

The following table is the setting of spectrum analyzer and receiver.

Receiver Parameter	Setting
Attenuation	Auto
Start ~ Stop Frequency	9kHz~150kHz / RB 200Hz for QP/Average
Start ~ Stop Frequency	150kHz~30MHz / RB 9kHz for QP/Average
Start ~ Stop Frequency	30MHz~1000MHz / RB 100kHz for QP

7.6. Test Procedure

1) Sequence of testing 9 kHz to 30 MHz

Setup:

- The equipment was set up to simulate a typical usage like described in the user manual or described by manufacturer.
- If the EUT is a tabletop system, a rotatable table with 0.8 m height is used.
- If the EUT is a floor standing device, it is placed on the ground.
- Auxiliary equipment and cables were positioned to simulate normal operation conditions.
- The AC power port of the EUT (if available) is connected to a power outlet below the turntable.
- The measurement distance is 3 meter.
- The EUT was set into operation.

Premeasurement:

- The turntable rotates from 0° to 315° using 45° steps.
- The antenna height is 1 meter.
- At each turntable position the analyzer sweeps with peak detection to find the maximum of all emissions

Final measurement:

- Identified emissions during the premeasurement the software maximizes by rotating the turntable position (0° to 360°) and by rotating the elevation axes (0° to 360°).
- The final measurement will be done in the position (turntable and elevation) causing the highest emissions with QPK detector.
- The final levels, frequency, measuring time, bandwidth, turntable position, correction factor, margin to the limit and limit will be recorded. Also a plot with the graph of the premeasurement and the limit will be stored.



2) Sequence of testing 30 MHz to 1 GHz

Setup:

- The equipment was set up to simulate a typical usage like described in the user manual or described by manufacturer.
- If the EUT is a tabletop system, a table with 0.8 m height is used, which is placed on the ground plane.
- If the EUT is a floor standing device, it is placed on the ground plane with insulation between both.
- Auxiliary equipment and cables were positioned to simulate normal operation conditions
- The AC power port of the EUT (if available) is connected to a power outlet below the turntable.
- The measurement distance is 3 meter.
- The EUT was set into operation.

Premeasurement:

- The turntable rotates from 0° to 315° using 45° steps.
- The antenna is polarized vertical and horizontal.
- The antenna height changes from 1 to 3 meter.
- At each turntable position, antenna polarization and height the analyzer sweeps three times in peak to find the maximum of all emissions.

Final measurement:

- The final measurement will be performed with minimum the six highest peaks.
- According to the maximum antenna and turntable positions of premeasurement the software maximize the peaks by changing turntable position ($\pm 45^\circ$) and antenna movement between 1 and 4 meter.
- The final measurement will be done with QP detector with an EMI receiver.
- The final levels, frequency, measuring time, bandwidth, antenna height, antenna polarization, turntable angle, correction factor, margin to the limit and limit will be recorded. Also a plot with the graph of the premeasurement with marked maximum final measurements and the limit will be stored.

7.7. Test Results

PASS.

Only report the worst test data mode 1 in test report;

The test data please refer to following page:

Temperature	23.6°C	Humidity	52.2%
Test Engineer	Monkey Li	Configurations	Transmit



0.009 MHz – 30 MHz

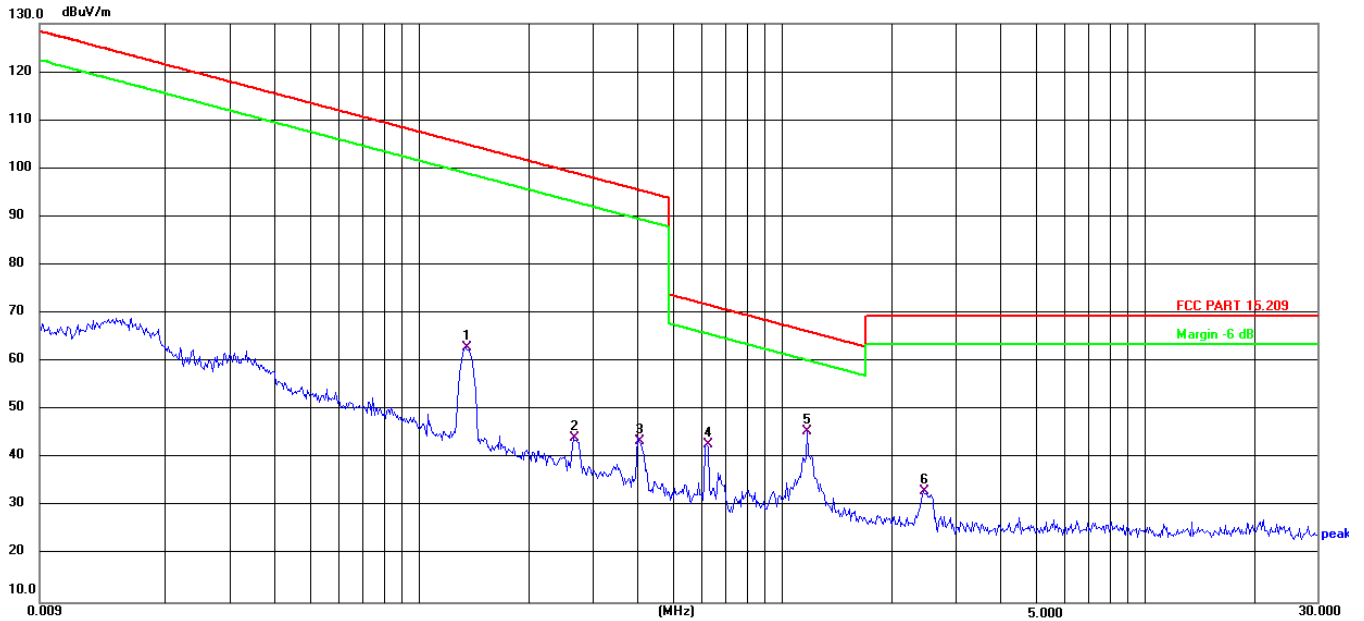

No.	Frequency (MHz)	Reading (dBuV)	Factor (dB/m)	Level (dBuV/m)	Limit (dBuV/m)	Margin (dB)	Det.
1	0.1352	72.31	-9.50	62.81	104.92	-42.11	QP
2	0.2672	53.18	-8.96	44.22	99.04	-54.82	QP
3	0.4041	52.13	-8.72	43.41	95.46	-52.05	QP
4	0.6211	51.03	-8.22	42.81	71.74	-28.93	QP
5 *	1.1789	52.41	-6.92	45.49	66.17	-20.68	QP
6	2.4665	37.64	-4.48	33.16	69.54	-36.38	QP

Remark: 1). Measured at antenna position 0 degree and 90 degree, recorded worst case at 0 degree
 2). Corrected Reading: Antenna Factor + Cable Loss + Read Level - Preamp Factor = Level.



Below 1GHz

Horizontal

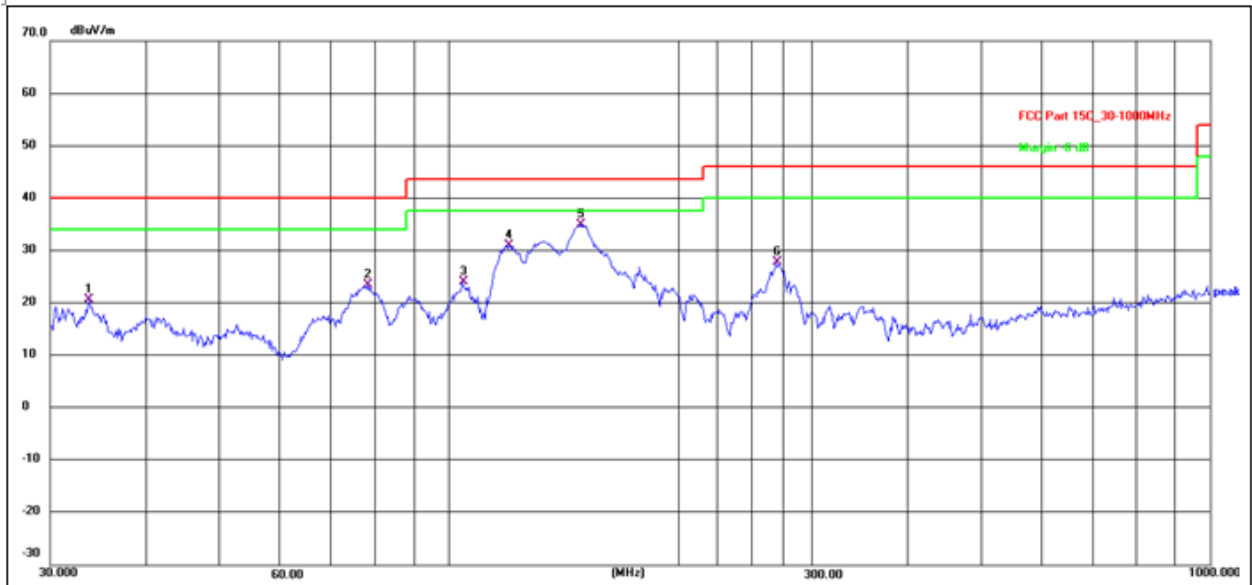

No.	Frequency (MHz)	Reading (dBuV)	Factor (dB/m)	Level (dBuV/m)	Limit (dBuV/m)	Margin (dB)	Det.
1	33.7986	38.67	-18.04	20.63	40.00	-19.37	QP
2	78.4133	41.25	-17.84	23.41	40.00	-16.59	QP
3	104.5361	39.13	-15.00	24.13	43.50	-19.37	QP
4	120.2766	47.92	-16.83	31.09	43.50	-12.41	QP
5 *	149.4857	53.47	-18.50	34.97	43.50	-8.53	QP
6	269.4284	43.36	-15.50	27.86	46.00	-18.14	QP



Vertical

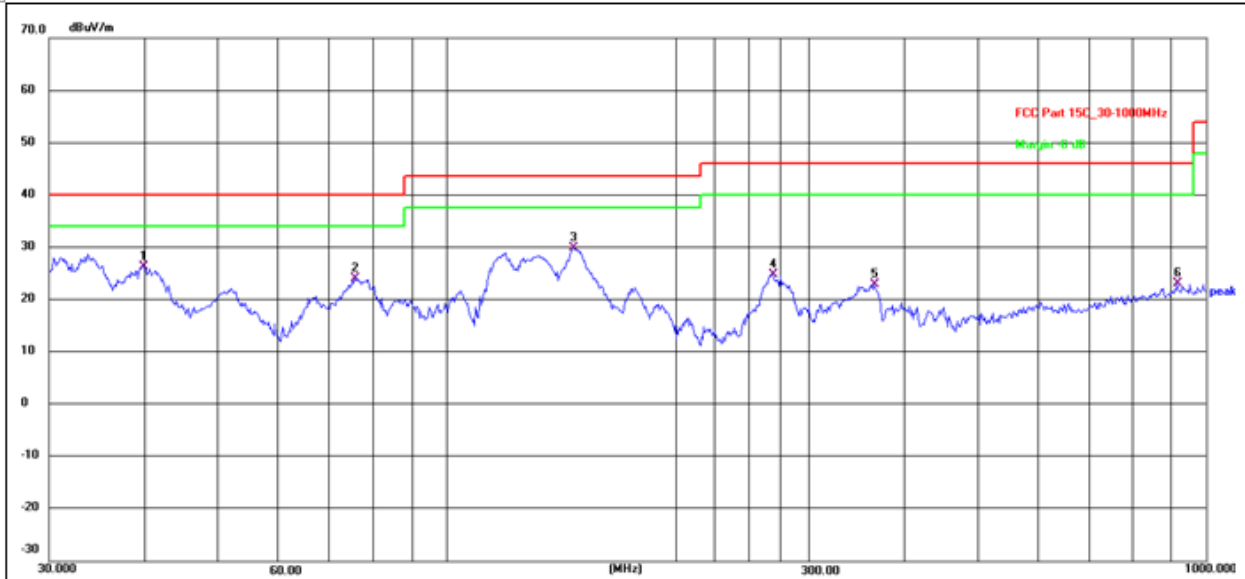

No.	Frequency (MHz)	Reading (dBuV)	Factor (dB/m)	Level (dBuV/m)	Limit (dBuV/m)	Margin (dB)	Det.
1 *	39.8542	44.05	-17.66	26.39	40.00	-13.61	QP
2	75.7114	42.06	-18.01	24.05	40.00	-15.95	QP
3	147.4036	48.50	-18.68	29.82	43.50	-13.68	QP
4	268.4853	40.30	-15.51	24.79	46.00	-21.21	QP
5	365.5391	37.80	-14.86	22.94	46.00	-23.06	QP
6	916.0687	30.23	-7.09	23.14	46.00	-22.86	QP

- 1). Emission level (dBuV/m) = 20 log Emission level (uV/m).
- 2). Corrected Reading: Antenna Factor + Cable Loss + Read Level - Preamp Factor = Level.



9. PHOTOGRAPHS OF TEST SETUP

Please refer to separated files for Test Setup Photos of the EUT.

10. EXTERNAL PHOTOGRAPHS OF THE EUT

Please refer to separated files for External Photos of the EUT.

11. INTERNAL PHOTOGRAPHS OF THE EUT

Please refer to separated files for Internal Photos of the EUT.

-----THE END OF REPORT-----