

**ELECTROMAGNETIC EMISSIONS COMPLIANCE REPORT  
INTENTIONAL RADIATOR CERTIFICATION TO  
FCC PART 15 SUBPART C REQUIREMENT**

*OF*

**Motorized Penis Stroking Machine With Insertable Sleeve**

**Model No.: Autoblow AI+, Autoblow AI+ Clear, Autoblow A.I. Plus,  
Autoblow A.I. Plus Clear, CG573**

**FCC ID: 2A4AW-AUTOBLOW-AI**

**Trademark: Autoblow<sup>®</sup>**

**Report No.: E01A22100615F00601**

**Issue Date: November 29, 2022**

*Prepared for*

**VERY INTELLIGENT ECOMMERCE INC.**

**109 E, 17th St, Suite 4, Cheyenne, WY 82001, United States**

*Prepared by*

**Dong Guan Anci Electronic Technology Co., Ltd.**

**1-2 Floor, Building A, No.11, Headquarters 2 Road, Songshan, Lake  
Hi-tech Industrial Development Zone, Dongguan City, Guangdong Pr.,  
China.**

**This report shall not be reproduced, except in full, without the written approval of  
Dong Guan Anci Eleaactronic Technology Co., Ltd.**

**VERIFICATION OF COMPLIANCE**

Applicant:	VERY INTELLIGENT ECOMMERCE INC.. 109 E, 17th St, Suite 4, Cheyenne, WY 82001, United States
Manufacturer:	VERY INTELLIGENT ECOMMERCE INC.. 109 E, 17th St, Suite 4, Cheyenne, WY 82001, United States
Product Description:	Motorized Penis Stroking Machine With Insertable Sleeve
Trade Mark:	<b>Autoblow</b> <sup>®</sup>
Model Number:	Autoblow AI+, Autoblow AI+ Clear, Autoblow A.I. Plus, Autoblow A.I. Plus Clear, CG573 (Note:All models are identical, except for model name and enclosure type.We choose model: Autoblow AI+ to do all the tests.)

**We hereby certify that:**

The above equipment was tested by Dong Guan Anci Electronic Technology Co., Ltd. The test data, data evaluation, test procedures, and equipment configurations shown in this report were made in accordance with the procedures given in ANSI C63.10-2013 and the energy emitted by the sample EUT tested as described in this report is in compliance with conducted and radiated emission limits of FCC Rules Part 15.247(2022).

Date of Test : November 08, 2022 to November 28, 2022



Prepared by : \_\_\_\_\_  
Duke Liu/Editor

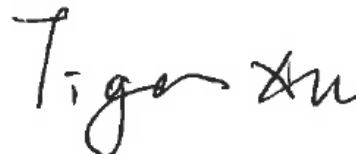

Reviewer & Authorized  
Signer : \_\_\_\_\_  
Tiger Xu/ Supervisor

**Modified Information**

Version	Summary	Revision Date	Report No.
Ver.1.0	Original Report	/	E01A22100615F00601

## Table of Contents

<b>1. GENERAL INFORMATION .....</b>	<b>5</b>
1.1 PRODUCT DESCRIPTION .....	5
1.2 TEST METHODOLOGY .....	5
<b>2. SYSTEM TEST CONFIGURATION.....</b>	<b>6</b>
2.1 EUT CONFIGURATION .....	6
2.2 EUT EXERCISE .....	6
2.3 TEST PROCEDURE .....	6
2.4 CONFIGURATION OF TESTED SYSTEM.....	6
<b>3. DESCRIPTION OF TEST MODES .....</b>	<b>8</b>
<b>4. SUMMARY OF TEST RESULTS.....</b>	<b>11</b>
<b>5. TEST FACILITY.....</b>	<b>12</b>
<b>6. CONDUCTED EMISSIONS TEST .....</b>	<b>13</b>
6.1 MEASUREMENT PROCEDURE: .....	13
6.2 TEST SET-UP (BLOCK DIAGRAM OF CONFIGURATION).....	13
6.3 MEASUREMENT EQUIPMENT USED: .....	13
6.4 CONDUCTED EMISSION LIMIT .....	13
6.5 MEASUREMENT RESULT:.....	14
<b>7. RADIATED EMISSION TEST .....</b>	<b>18</b>
7.1 MEASUREMENT PROCEDURE .....	18
7.2 TEST SET-UP (BLOCK DIAGRAM OF CONFIGURATION).....	19
7.3 MEASUREMENT EQUIPMENT USED .....	20
7.4 RADIATED EMISSION LIMIT .....	21
7.5 MEASUREMENT RESULT .....	22
<b>8. 6DB BANDWIDTH TEST .....</b>	<b>29</b>
8.1 MEASUREMENT PROCEDURE .....	29
8.2 TEST SET-UP (BLOCK DIAGRAM OF CONFIGURATION).....	29
8.3 MEASUREMENT EQUIPMENT USED .....	29
8.4 MEASUREMENT RESULTS.....	29
<b>9. MAXIMUM PEAK OUTPUT POWER TEST .....</b>	<b>30</b>
9.1 MEASUREMENT PROCEDURE .....	36
9.2 TEST SET-UP (BLOCK DIAGRAM OF CONFIGURATION).....	36
9.3 MEASUREMENT EQUIPMENT USED .....	36
9.4 PEAK POWER OUTPUT LIMIT .....	36
9.5 MEASUREMENT RESULTS.....	36
<b>10. BAND EDGE TEST .....</b>	<b>37</b>
10.1 MEASUREMENT PROCEDURE .....	37
10.2 TEST SET-UP (BLOCK DIAGRAM OF CONFIGURATION).....	38
10.3 MEASUREMENT EQUIPMENT USED .....	38
10.4 MEASUREMENT RESULTS.....	38
<b>11. POWER DENSITY .....</b>	<b>46</b>
11.1 TEST EQUIPMENT .....	46
11.2 MEASURING INSTRUMENTS AND SETTING.....	46
11.3 TEST PROCEDURES.....	46
11.4 BLOCK DIAGRAM OF TEST SETUP .....	46
11.5 LIMIT.....	47
11.6 TEST RESULT.....	47
<b>12. ANTENNA PORT EMISSION .....</b>	<b>53</b>

- 12.1 TEST EQUIPMENT ..... 53
- 12.2 MEASURING INSTRUMENTS AND SETTING..... 53
- 12.3 TEST PROCEDURES..... 53
- 12.4 BLOCK DIAGRAM OF TEST SETUP..... 53
- 12.5 TEST RESULT ..... 53
- 13. ANTENNA APPLICATION ..... 64**
  - 13.1 ANTENNA REQUIREMENT..... 64
  - 13.2 RESULT ..... 64
- 14. PHOTOS OF EUT ..... 65**

## 1. General Information

### 1.1 Product Description

Characteristics	Description
Product Name	Motorized Penis Stroking Machine With Insertable Sleeve
Model number	Autoblow AI+
Power Supply	DC 12V, 3A
Test Power Supply	DC 12V from adapter
Adapter Information	Model: LY036SPS-120300U1 Input: AC 100-240V, 50/60Hz Output: DC 12V, 3A Model: GQ36-120300-AX Input: AC 100-240V, 50/60Hz Output: DC 12V, 3A
Modulation	802.11b: DSSS(DBPSK/DQPSK/CCK) 802.11g/n: OFDM(BPSK/QPSK/16QAM/64QAM)
Operating Frequency Range	2412-2462MHz for 802.11b/g; 2412-2462MHz for 802.11n(HT20);
Number of Channels	11 channels for 802.11b/g; 11 channels for 802.11n(HT20);
Transmit Power Max	802.11b: 6.45dBm 802.11g: 6.40dBm 802.11n(HT20): 6.27dBm
Antenna Type	Internal PCB antenna
Antenna Gain	-2.49dBi
Sample receipt date	November 08, 2022

**Note:** for more details, please refer to the User's manual of the EUT.

### 1.2 Test Methodology

All the test program has follow FCC new test procedure KDB 558074 D01 15.247 Meas Guidance v05r02 and in accordance with the procedures given in ANSI C63.10-2013.

## 2. System Test Configuration

### 2.1 EUT Configuration

The EUT configuration for testing is installed on RF field strength measurement to meet the Commissions requirement and operating in a manner which intends to maximize its emission characteristics in a continuous normal application.

### 2.2 EUT Exercise

The Transmitter was operated in the normal operating mode. The TX frequency was fixed which was for the purpose of the measurements.

### 2.3 Test Procedure

#### 2.1.2 Conducted Emissions

The EUT is a placed on as turn table which is 0.8 m above ground plane. According to the requirements in Section 13.1.4.1 of ANSI C63.10-2013 Conducted emissions from the EUT measured in the frequency range between 0.15 MHz and 30 MHz using CISPR Quasi-Peak and average detector mode.

#### 2.3.2 Radiated Emissions

The EUT is a placed on as turn table which is 0.8 m above ground plane. The turn table shall rotate 360 degrees to determine the position of maximum emission level. EUT is set 3m away from the receiving antenna which varied from 1m to 4m to find out the highest emission. And also, each emission was to be maximized by changing the polarization of receiving antenna both horizontal and vertical. In order to find out the max. Emission, the relative positions of this hand-held transmitter (EUT) was rotated through three orthogonal axes according to the requirements in Section 13.1.4.1 of ANSI C63.10-2013.

### 2.4 Configuration of Tested System

**Fig. 2-1 Configuration of Tested System**

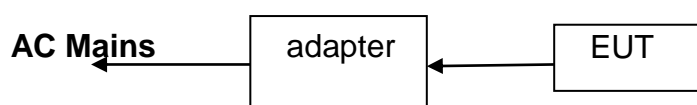

**Table 2-1 Equipment Used in Tested System**

Item	Equipment	Trademark	Model No.	FCC ID	Note
1.	Motorized Penis Stroking Machine With Insertable Sleeve	Autoblow	Autoblow AI+	2A4AW-AUTOBLOW-AI	<i>EUT</i>
2.	Adapter 1	Lyangel	LY036SPS-120300U1	N/A	<i>Support EUT</i>

3.	Adapter 2	GQ	GQ36-120300-AX	N/A	<b>Support EUT</b>
----	-----------	----	----------------	-----	------------------------

**Note:**

- (1) Unless otherwise denoted as EUT in 『Remark』 column, device(s) used in tested system is a support equipment.



### 3. Description of Test Modes

The EUT has been tested under its typical operating condition and Only the worst case data were reported. The EUT configuration for testing is installed on RF field strength measurement to meet the Commissions requirement and operating in a manner which intends to maximize its emission characteristics in a continuous normal application.

The Transmitter was operated in the normal operating mode. The TX frequency was fixed which was for the purpose of the measurements.

Test of channel included the lowest and middle and highest frequency to perform the test, then record on this report.

Those data rates (802.11b: 1 Mbps; 802.11g: 6 Mbps; 802.11n (HT20 ): MCS0) were used for all test. Pre-defined engineering program for regulatory testing used to control the EUT for staying in continuous transmitting mode is programmed. EUT is connected by com port, and transmit the control instruction via test software(EspRFTestTool\_v2.8).

Frequency and Channel list for 802.11 b/g/n (HT20):

Channel	Frequency (MHz)	Channel	Frequency (MHz)	Channel	Frequency (MHz)
1	2412	5	2432	9	2452
2	2417	6	2437	10	2457
3	2422	7	2442	11	2462
4	2427	8	2447		

Test Frequency and Channel for 802.11 b/g/n (HT20):

Lowest Frequency		Middle Frequency		Highest Frequency	
Channel	Frequency (MHz)	Channel	Frequency (MHz)	Channel	Frequency (MHz)
1	2412	6	2437	11	2462

Operated Mode for Worst Duty cycle:

Duty Cycle:

Mode	Frequency (MHz)	Duty Cycle (%)	Correction Factor (dB)
802.11b	2412	100	0
802.11b	2437	100	0
802.11b	2462	100	0
802.11g	2412	100	0
802.11g	2437	100	0
802.11g	2462	100	0
802.11n(HT20)	2412	100	0
802.11n(HT20)	2437	100	0
802.11n(HT20)	2462	100	0

All the modulation modes were tested the data of the worst mode (TX 802.11b) are recorded in the following pages:

### Duty Cycle NVNT b 2412MHz Ant1

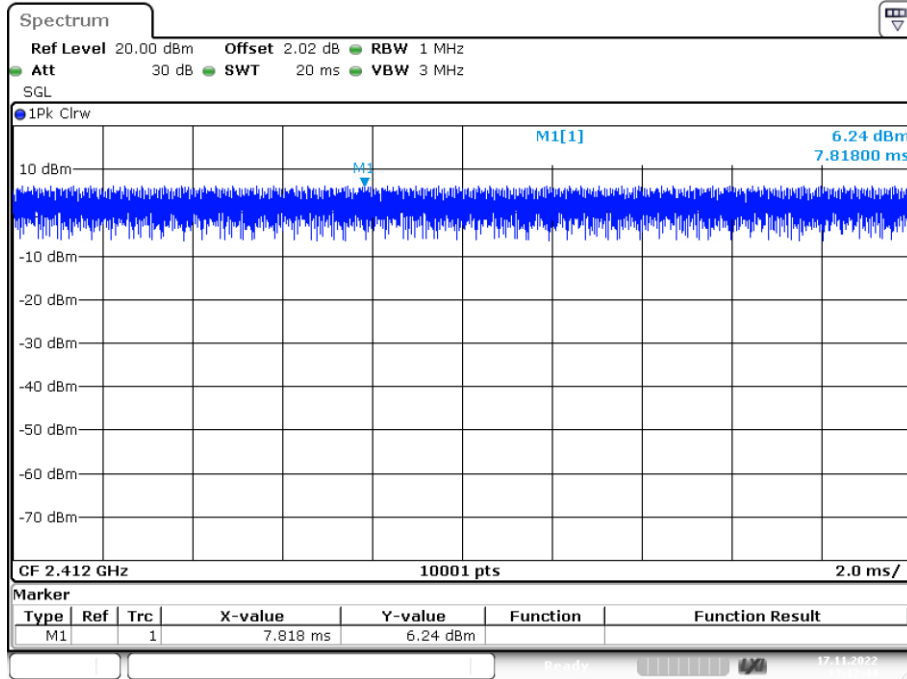

Date: 17.NOV.2022 13:12:44

### Duty Cycle NVNT b 2437MHz Ant1

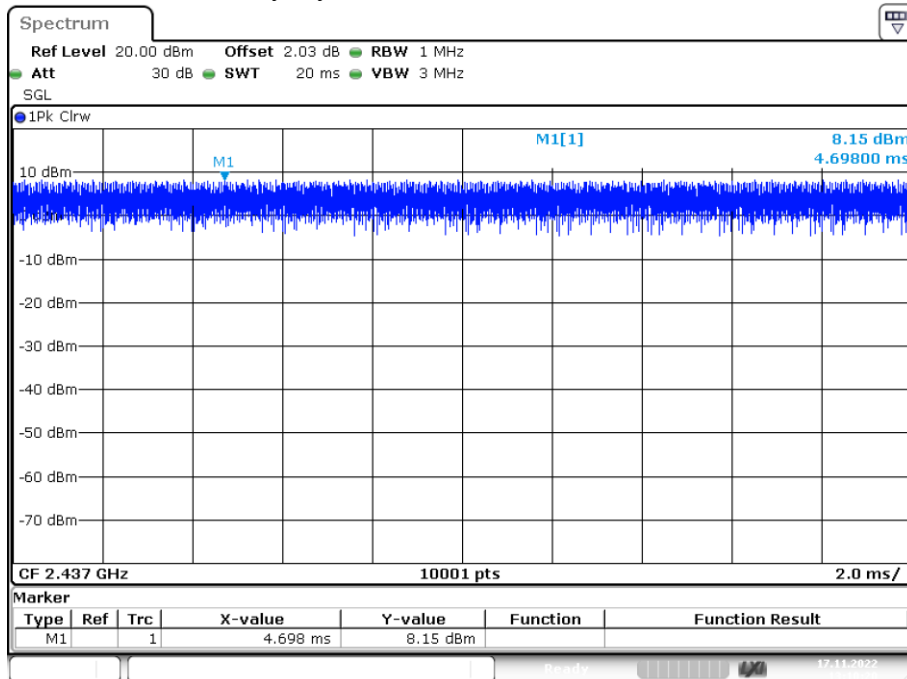

Date: 17.NOV.2022 13:10:19

### Duty Cycle NVNT b 2462MHz Ant1

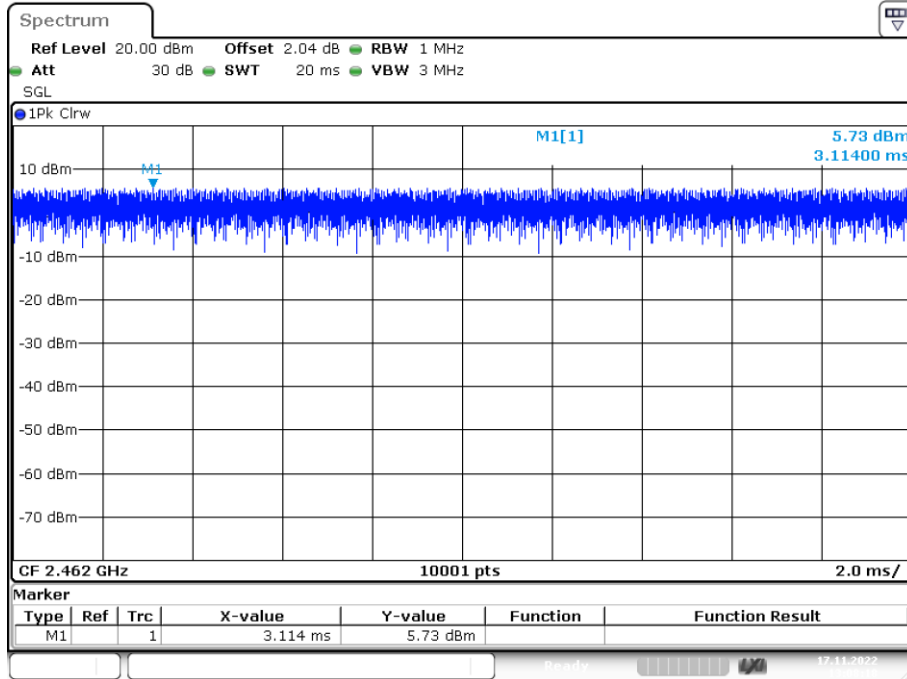

Date: 17.NOV.2022 13:08:17

#### 4. Summary of Test Results

<b>FCC Rules</b>	<b>Description Of Test</b>	<b>Result</b>
§15.247(a)(2)	6dB bandwidth	Pass
§15.247(b)(3)	Max Peak output Power test	Pass
§15.247(e)	Power density	Pass
§15.247(d)	Band edge test	Pass
§15.207	AC Power Conducted Emission	Pass
§15.247(d), §15.209	Radiated Emission	Pass
§15.247(d)	Antenna Port Emission	Pass
§15.247(b)&§15.203	Antenna Application	Pass
N/A (Not Applicable).		

## 5. Test Facility

### Site Description

Name of Firm : Dong Guan Anci Electronic Technology Co., Ltd.  
Site Location : 1-2 Floor, Building A, No.11, Headquarters 2 Road,  
Songshan, Lake Hi-tech Industrial Development  
Zone, Dongguan City, Guangdong Pr., China.

## 6. Conducted Emissions Test

### 6.1 Measurement Procedure:

1. The EUT was placed on a table, which is 0.8m above ground plane.
2. Maximum procedure was performed on the six highest emissions to ensure EUT compliance.
3. Repeat above procedures until all frequency measured was complete.

### 6.2 Test SET-UP (Block Diagram of Configuration)

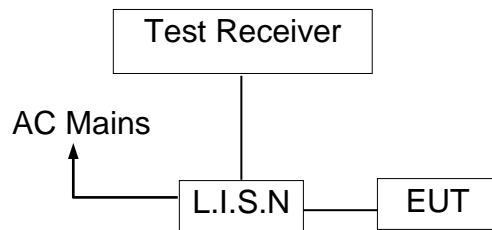

### 6.3 Measurement Equipment Used:

Conducted Emission Test Site				
EQUIPMENT TYPE	MFR	MODEL NUMBER	SERIAL NUMBER	Calibrated until
L.I.S.N	SCHWARZBECK	NSLK 8127	8127-669	2023-05-12
10 db attenuator	JFW	50FP-010-H4	4360846-427-1	2023-05-12
RF Cable	N/A	N/A	2#	2023-05-12
EMI Test Receiver	ROHDE&SCHWARZ	ESCI	101358	2023-05-12
Shielded Room	chengyu	8m*4m*3m	N/A	2023-05-12
Test Software	Farad	EZ-EMC Ver:ANCI-8A1	N/A	N/A

### 6.4 Conducted Emission Limit

#### (7) Conducted Emission Frequency(MHz)

0.15-0.5  
0.5-5.0  
5.0-30.0

#### Quasi-peak

66-56  
56  
60

#### Average

56-46  
46  
50

#### Note:

1. The lower limit shall apply at the transition frequencies
2. The limit decreases in line with the logarithm of the frequency in the range of 0.15 to 0.50MHz.

**6.5 Measurement Result:**

All the modulation modes were tested the data of the worst mode (802.11 b TX2412) are recorded in the following pages and the others modulation methods do not exceed the limits. Please refer to following pages.

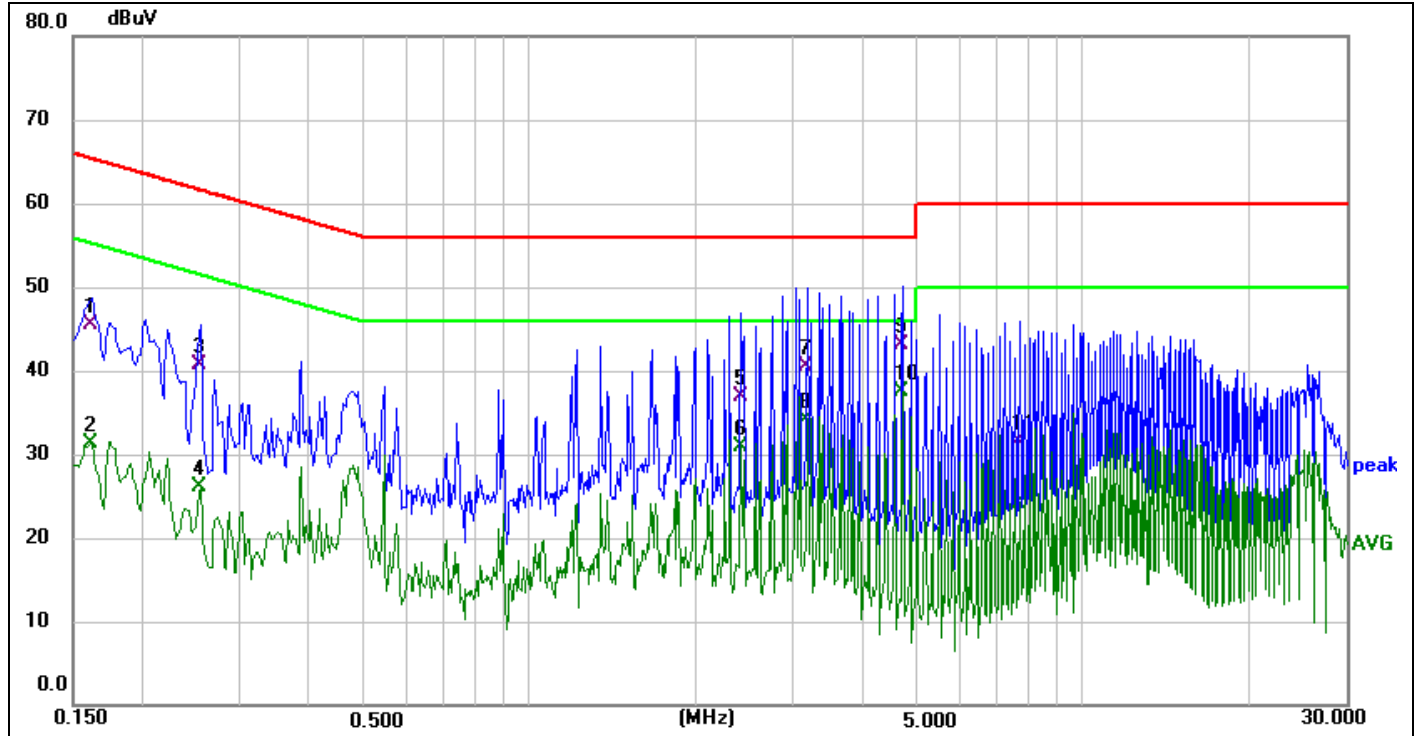

Site:	843	Phase:L1	Temperature(C):26(C)
Limit:	FCC PART 15C Conduction(QP)	Test Time:	Humidity(%):60%
EUT:	Motorized Penis Stroking Machine With Insertable Sleeve	Test Time:	2022-11-15
M/N.:	Autoblow AI+	Power Rating:	AC 120V/60Hz
Mode:	WIFI TX2412	Test Engineer:	Sunshine
Note:	Adapter: GQ36-120300-AX		

No.	Frequency (MHz)	Reading Level(dBuV)	Factor (dB)	Measurement(dBuV)	Limit (dBuV)	Over (dB)	Detector	Comment
1	0.1620	35.47	9.97	45.44	65.36	-19.92	QP	
2	0.1620	21.35	9.97	31.32	55.36	-24.04	AVG	
3	0.2540	30.84	9.91	40.75	61.63	-20.88	QP	
4	0.2540	16.11	9.91	26.02	51.63	-25.61	AVG	
5	2.4180	26.70	10.13	36.83	56.00	-19.17	QP	
6	2.4180	20.75	10.13	30.88	46.00	-15.12	AVG	
7	3.1780	30.28	10.18	40.46	56.00	-15.54	QP	
8	3.1780	23.87	10.18	34.05	46.00	-11.95	AVG	
9	4.7220	32.73	10.30	43.03	56.00	-12.97	QP	
10 *	4.7220	27.30	10.30	37.60	46.00	-8.40	AVG	
11	7.6980	20.97	10.47	31.44	60.00	-28.56	QP	
12	7.6980	13.60	10.47	24.07	50.00	-25.93	AVG	

\*:Maximum data x:Over limit !:over margin  
TRF No.: 01-R001-3A-WIFI

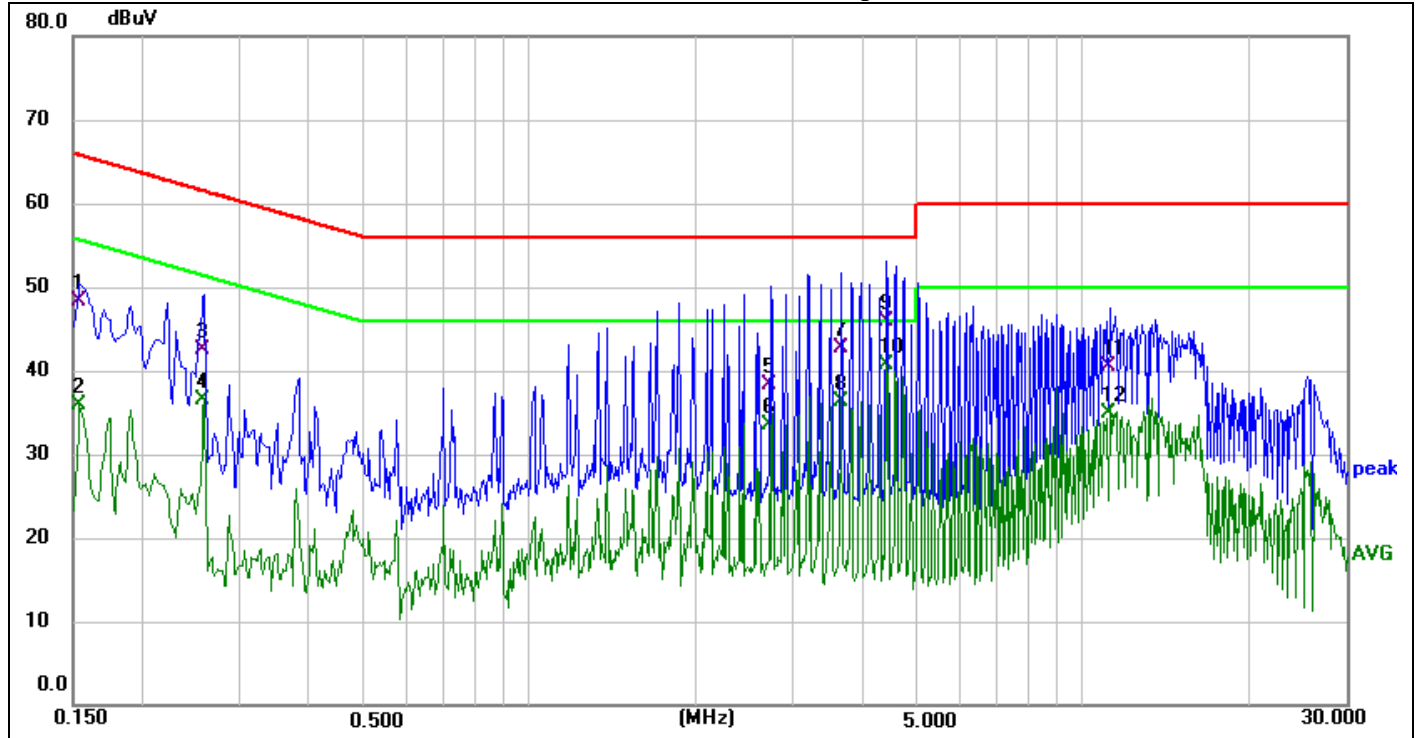

<b>Site:</b>	<b>843</b>	<b>Phase:</b>	<b>N</b>	<b>Temperature(C):</b>	<b>26(C)</b>
<b>Limit:</b>	<b>FCC PART 15C Conduction(QP)</b>	<b>Test Time:</b>		<b>Humidity(%):</b>	<b>60%</b>
<b>EUT:</b>	<b>Motorized Penis Stroking Machine With Insertable Sleeve</b>	<b>Power Rating:</b>		<b>Test Time:</b>	<b>2022-11-15</b>
<b>M/N.:</b>	<b>Autoblow AI+</b>	<b>Test Engineer:</b>			
<b>Mode:</b>	<b>WIFI TX2412</b>				
<b>Note:</b>	<b>Adapter: GQ36-120300-AX</b>				

No.	Frequency (MHz)	Reading Level(dBuV)	Factor (dB)	Measurement(dBuV)	Limit (dBuV)	Over (dB)	Detector	Comment
1	0.1539	38.39	9.97	48.36	65.79	-17.43	QP	
2	0.1539	25.91	9.97	35.88	55.79	-19.91	AVG	
3	0.2580	32.56	9.90	42.46	61.50	-19.04	QP	
4	0.2580	26.65	9.90	36.55	51.50	-14.95	AVG	
5	2.7260	28.12	10.15	38.27	56.00	-17.73	QP	
6	2.7260	23.41	10.15	33.56	46.00	-12.44	AVG	
7	3.6780	32.44	10.23	42.67	56.00	-13.33	QP	
8	3.6780	26.07	10.23	36.30	46.00	-9.70	AVG	
9	4.4220	35.63	10.28	45.91	56.00	-10.09	QP	
10 *	4.4220	30.35	10.28	40.63	46.00	-5.37	AVG	
11	11.1620	29.94	10.55	40.49	60.00	-19.51	QP	
12	11.1620	24.34	10.55	34.89	50.00	-15.11	AVG	

\*:Maximum data x:Over limit !:over margin



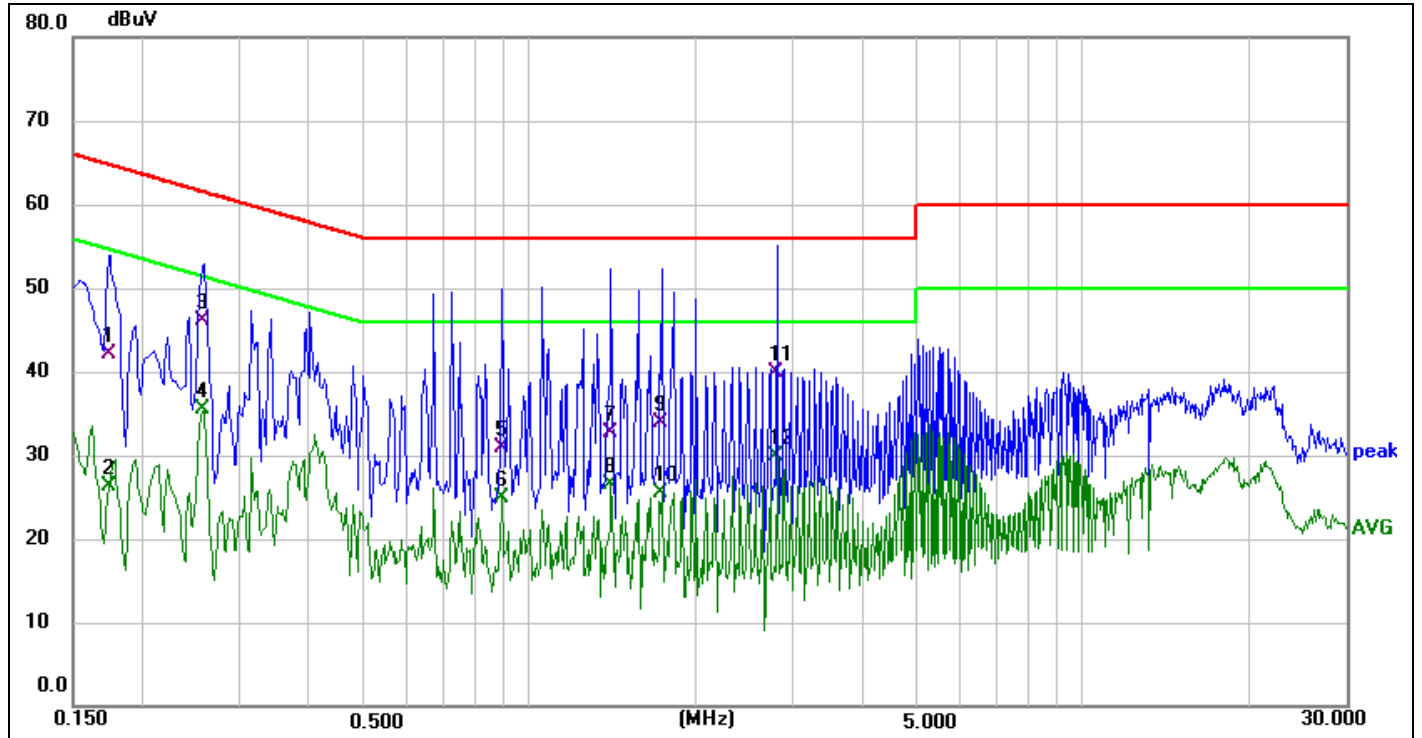

<b>Site:</b>	<b>843</b>	<b>Phase:</b>	<b>L1</b>	<b>Temperature(C):</b>	<b>26(C)</b>
<b>Limit:</b>	<b>FCC PART 15C Conduction(QP)</b>	<b>Test Time:</b>		<b>Humidity(%):</b>	<b>60%</b>
<b>EUT:</b>	<b>Motorized Penis Stroking Machine With Insertable Sleeve</b>	<b>Power Rating:</b>		<b>2022-11-15</b>	
<b>M/N.:</b>	<b>Autoblow AI+</b>	<b>Test Engineer:</b>			
<b>Mode:</b>	<b>WIFI TX2412</b>				
<b>Note:</b>	<b>Adapter: LY036SPS-120300U1</b>				

No.	Frequency (MHz)	Reading Level(dBuV)	Factor (dB)	Measurement(dBuV)	Limit (dBuV)	Over (dB)	Detector	Comment
1	0.1740	32.21	9.97	42.18	64.77	-22.59	QP	
2	0.1740	16.40	9.97	26.37	54.77	-28.40	AVG	
3 *	0.2580	36.29	9.90	46.19	61.50	-15.31	QP	
4	0.2580	25.59	9.90	35.49	51.50	-16.01	AVG	
5	0.8940	20.68	10.17	30.85	56.00	-25.15	QP	
6	0.8940	14.72	10.17	24.89	46.00	-21.11	AVG	
7	1.4100	22.66	10.13	32.79	56.00	-23.21	QP	
8	1.4100	16.46	10.13	26.59	46.00	-19.41	AVG	
9	1.7380	23.81	10.11	33.92	56.00	-22.08	QP	
10	1.7380	15.40	10.11	25.51	46.00	-20.49	AVG	
11	2.8020	29.83	10.16	39.99	56.00	-16.01	QP	
12	2.8020	19.68	10.16	29.84	46.00	-16.16	AVG	

\*:Maximum data x:Over limit !:over margin

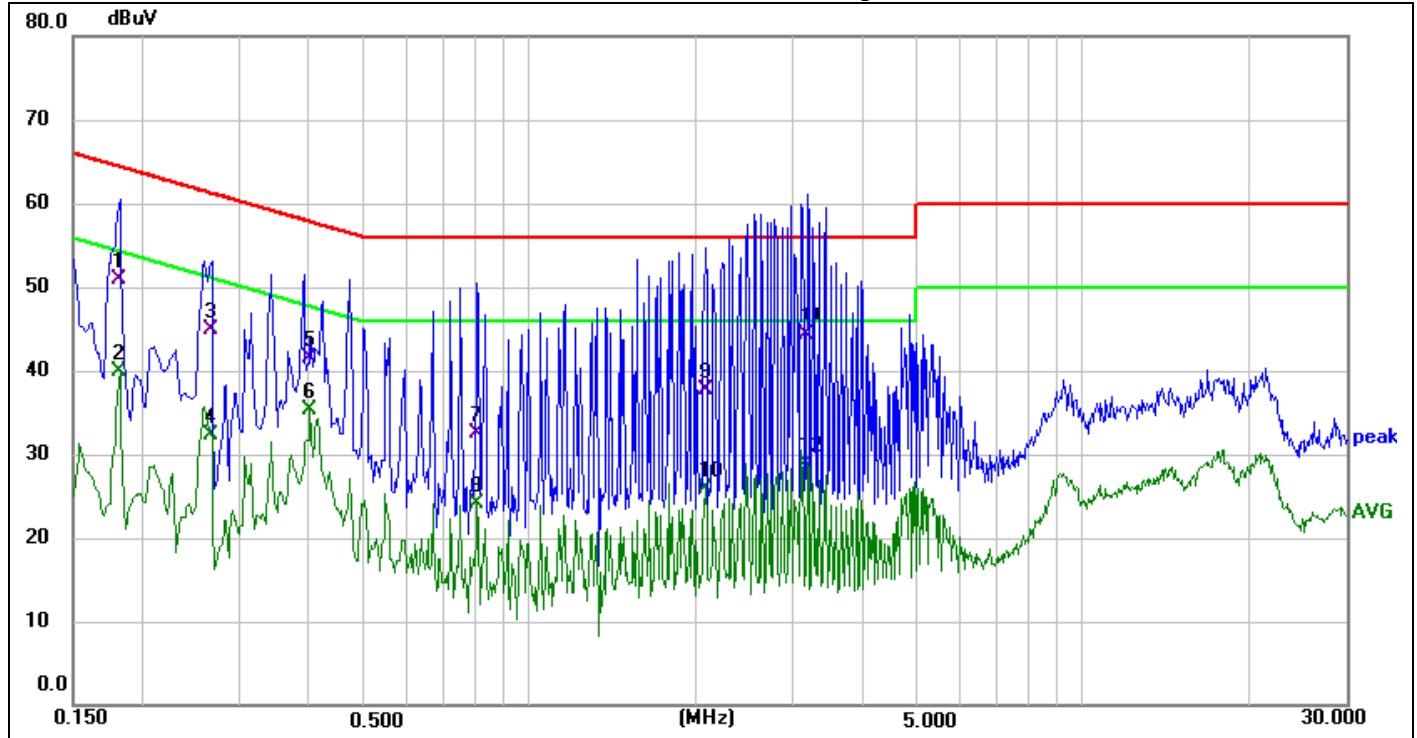

<b>Site:</b>	<b>843</b>	<b>Phase:</b>	<b>N</b>	<b>Temperature(C):</b>	<b>26(C)</b>
<b>Limit:</b>	<b>FCC PART 15C Conduction(QP)</b>			<b>Humidity(%):</b>	<b>60%</b>
<b>EUT:</b>	<b>Motorized Penis Stroking Machine With Insertable Sleeve</b>	<b>Test Time:</b>			<b>2022-11-15</b>
<b>M/N.:</b>	<b>Autoblow AI+</b>	<b>Power Rating:</b>			<b>AC 120V/60Hz</b>
<b>Mode:</b>	<b>WIFI TX2412</b>	<b>Test Engineer:</b>			<b>Sunshine</b>
<b>Note:</b>	<b>Adapter: LY036SPS-120300U1</b>				

No.	Frequency (MHz)	Reading Level(dBuV)	Factor (dB)	Measurement(dBuV)	Limit (dBuV)	Over (dB)	Detector	Comment
1	0.1819	40.94	9.97	50.91	64.40	-13.49	QP	
2	0.1819	29.84	9.97	39.81	54.40	-14.59	AVG	
3	0.2660	35.01	9.90	44.91	61.24	-16.33	QP	
4	0.2660	22.38	9.90	32.28	51.24	-18.96	AVG	
5	0.4020	31.81	9.74	41.55	57.81	-16.26	QP	
6	0.4020	25.63	9.74	35.37	47.81	-12.44	AVG	
7	0.8059	22.25	10.17	32.42	56.00	-23.58	QP	
8	0.8059	13.86	10.17	24.03	46.00	-21.97	AVG	
9	2.0860	27.65	10.10	37.75	56.00	-18.25	QP	
10	2.0860	15.83	10.10	25.93	46.00	-20.07	AVG	
11 *	3.1740	34.04	10.18	44.22	56.00	-11.78	QP	
12	3.1740	18.69	10.18	28.87	46.00	-17.13	AVG	

\*:Maximum data x:Over limit !:over margin

## 7. Radiated Emission Test

### 7.1 Measurement Procedure

1. Below 1000MHz, The EUT was placed on a turn table which is 0.8m above ground plane, And above 1000MHz, The EUT was placed on a styrofoam table which is 1.5m above ground plane.
2. Maximum procedure was performed on the six highest emissions to ensure EUT compliance.
3. And also, each emission was to be maximized by changing the polarization of receiving antenna both horizontal and vertical.
4. Repeat above procedures until all frequency measured was complete.

When spectrum scanned from 30MHz to 1GHz setting resolution bandwidth 120KHz and video bandwidth 300KHz:

EMI Test Receiver	Setting
Attenuation	Auto
RB	120KHz
VB	300KHz
Detector	QP
Trace	Max hold

When spectrum scanned above 1GHz setting resolution bandwidth 1MHz, video bandwidth 3MHz:

EMI Test Receiver	Setting
Attenuation	Auto
RB	1MHz
VB	3MHz
Detector	Peak
Trace	Max hold

When spectrum scanned above 1GHz setting resolution bandwidth 1MHz, video bandwidth 10Hz:

EMI Test Receiver	Setting
Attenuation	Auto
RB	1MHz
VB	10Hz
Detector	Peak
Trace	Max hold

### 7.2 Test SET-UP (Block Diagram of Configuration)

(A) Radiated Emission Test Set-Up, Frequency Below 30MHz

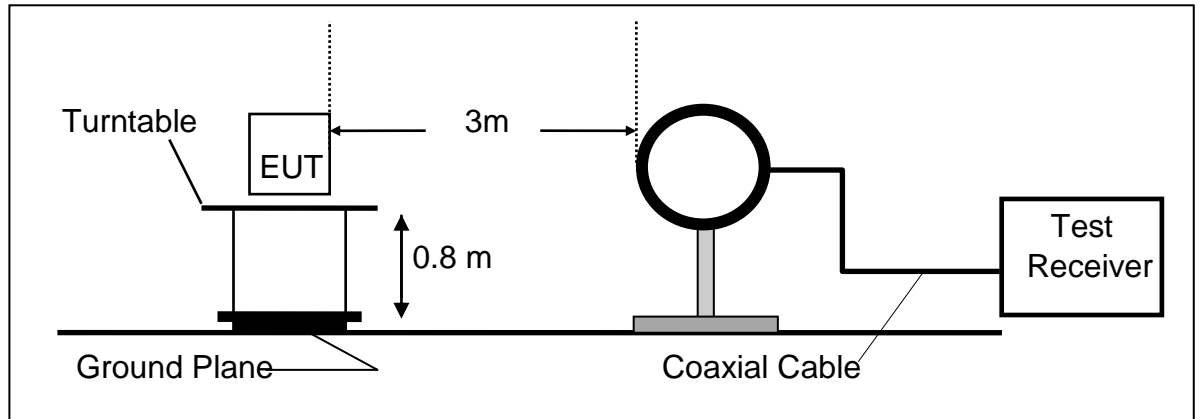

(B) Radiated Emission Test Set-Up, Frequency Below 1000MHz

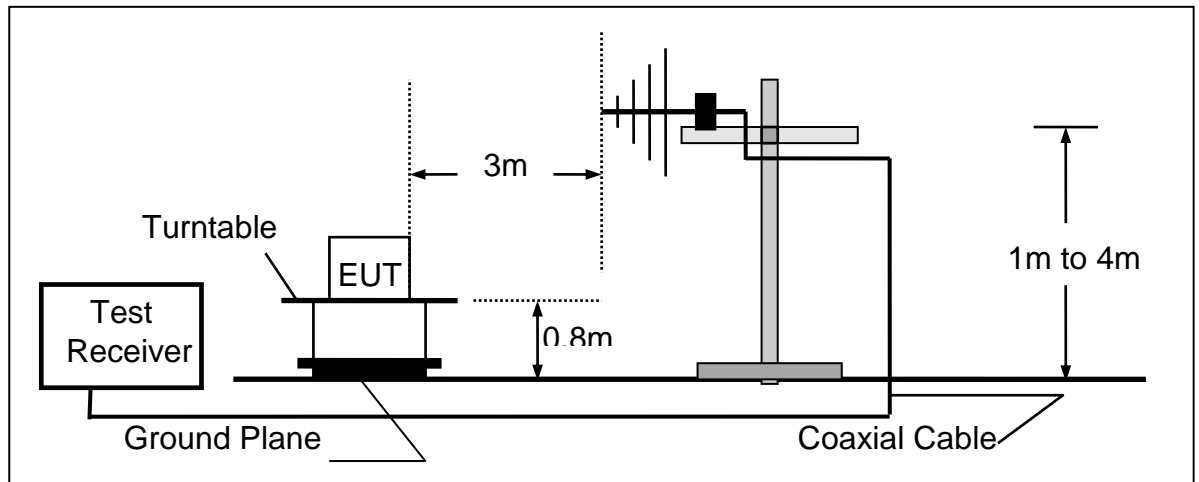

## (C) Radiated Emission Test Set-Up, Frequency above 1000MHz

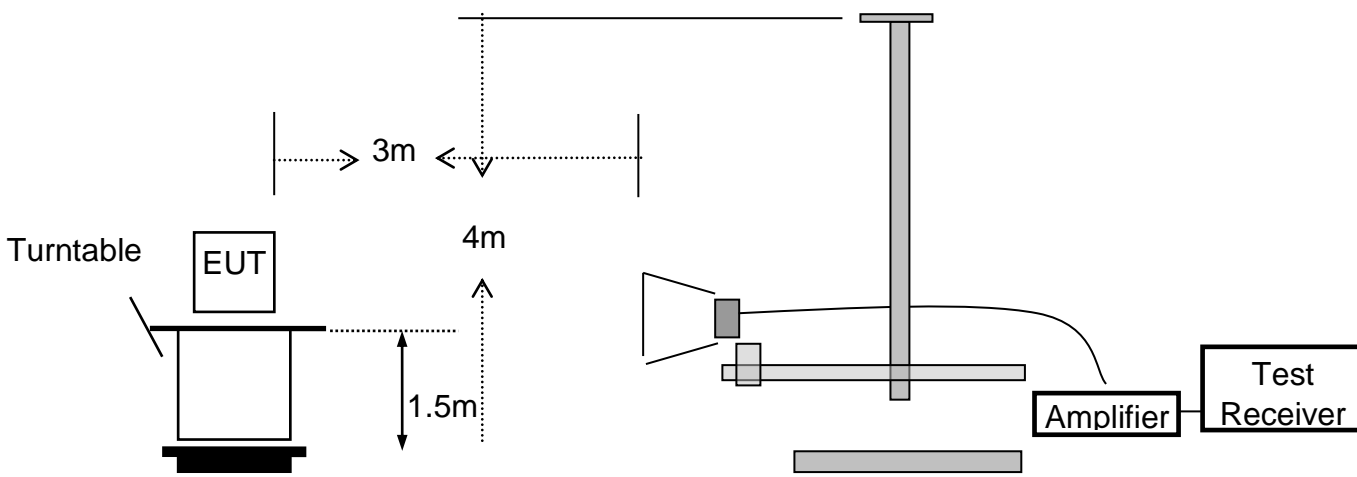

### 7.3 Measurement Equipment Used

Item	Equipment	Manufacturer	Model No.	Serial No.	Calibrated until
1.	EMI Test Receiver	Rohde & Schwarz	ESPI	100502	2023-10-28
2.	Pre-Amplifier	HP	8447D	2727A06172	2023-05-12
3.	Bilog Antenna	Schwarzbeck	VULB9163	VULB9163-588	2023-05-12
4.	Loop Antenna	Schwarzbeck	FMZB 1516	1516-141	2023-10-28
5.	Spectrum Analyzer	Rohde & Schwarz	FSV40	US40240623	2023-10-28
6.	Low noise Amplifiers	A-INFO	LA1018N4009	J101313052400 1	2023-05-12
7.	Horn antenna	A-INFO	LB-10180-SF	J203109061212 3	2023-05-12
8.	Broadband RF Power Amplifier	AEROFLEX	AEROFLEX10 0KHz-40GHz	J101313052400 1	2023-10-28
9.	DRG Horn Antenna	A.H.SYSTEMS	SAS-574	J203109061212 3	2023-10-28
10.	RF Cable	Gigalink Microwave	ZT40-2.92J-2. 92J-2m	N/A	2023-10-28
11.	RF Cable	Gigalink Microwave	ZT40-2.92J-2. 92J-0.3m	N/A	2023-10-28
12.	RF Cable	N/A	N/A	6#	2023-05-12
13.	RF Cable	N/A	N/A	1-1#	2023-05-12
14.	RF Cable	N/A	N/A	1-2#	2023-05-12
15.	RF Cable	N/A	N/A	7#	2023-05-12
16.	3m Semi-anechoic Chamber	chengyu	9m*6m*6m	N/A	2023-05-12
17.	Test Software	Farad	EZ-EMC Ver:ANCI-3A1	N/A	N/A

#### 7.4 Radiated Emission Limit

The emissions from an intentional radiator shall not exceed the field strength levels specified in the following table 15.209(a):

Frequencies (MHz)	Field Strength (micorvolts/meter)	Measurement Distance (meters)
0.009~0.490	2400/F(KHz)	300
0.490~1.705	24000/F(KHz)	30
1.705~30.0	30	30
30~88	100	3
88~216	150	3
216~960	200	3
Above 960	500	3

#### 15.205 Restricted bands of operation

MHz	MHz	MHz	GHz
0.090 - 0.110	16.42 - 16.423	399.9 - 410	4.5 - 5.15
<sup>1</sup> 0.495 - 0.505	16.69475 - 16.69525	608 - 614	5.35 - 5.46
2.1735 - 2.1905	16.80425 - 16.80475	960 - 1240	7.25 - 7.75
4.125 - 4.128	25.5 - 25.67	1300 - 1427	8.025 - 8.5
4.17725 - 4.17775	37.5 - 38.25	1435 - 1626.5	9.0 - 9.2
4.20725 - 4.20775	73 - 74.6	1645.5 - 1646.5	9.3 - 9.5
6.215 - 6.218	74.8 - 75.2	1660 - 1710	10.6 - 12.7
6.26775 - 6.26825	108 - 121.94	1718.8 - 1722.2	13.25 - 13.4
6.31175 - 6.31225	123 - 138	2200 - 2300	14.47 - 14.5
8.291 - 8.294	149.9 - 150.05	2310 - 2390	15.35 - 16.2
8.362 - 8.366	156.52475 - 156.52525	2483.5 - 2500	17.7 - 21.4
8.37625 - 8.38675	156.7 - 156.9	2690 - 2900	22.01 - 23.12
8.41425 - 8.41475	162.0125 - 167.17	3260 - 3267	23.6 - 24.0
12.29 - 12.293	167.72 - 173.2	3332 - 3339	31.2 - 31.8
12.51975 - 12.52025	240 - 285	3345.8 - 3358	36.43 - 36.5
12.57675 - 12.57725	322 - 335.4	3600 - 4400	( <sup>2</sup> )

Remark 1. Emission level in dBuV/m=20 log (uV/m)

: 2. Measurement was performed at an antenna to the closed point of EUT distance of meters.

3. Only spurious frequency is permitted to locate within the Restricted Bands specified in provision of § 15.205, and the emissions located in restricted bands also comply with 15.209 limit.

## 7.5 Measurement Result

### Below 30MHz:

All the modulation modes were tested the data of the test mode are recorded in the following pages.

Operation Mode:	TX Mode	Test Date :	2022-11-15
Frequency Range:	9KHz~30MHz	Temperature :	26°C
Test Result:	PASS	Humidity :	60 %
Measured Distance:	3m	Test By:	Big

Freq. (MHz)	Ant.Pol. H/V	Emission Level (dBuV/m)	Limit 3m (dBuV/m)	Over (dB)
--	--	--	--	--

Note: the amplitude of spurious emission that is attenuated by more than 20dB below the permissible limit has no need to be reported.

Distance extrapolation factor =  $40 \log(\text{Specific distance} / \text{test distance})$  (dB);

Limit line = Specific limits (dBuV) + distance extrapolation factor.

### Below 1000MHz:

All the modulation modes were tested the data of the worst mode (TX 802.11b 2412MHz) are recorded in the following pages and the others modulation methods do not exceed the limits.

Please refer to the following test plots:

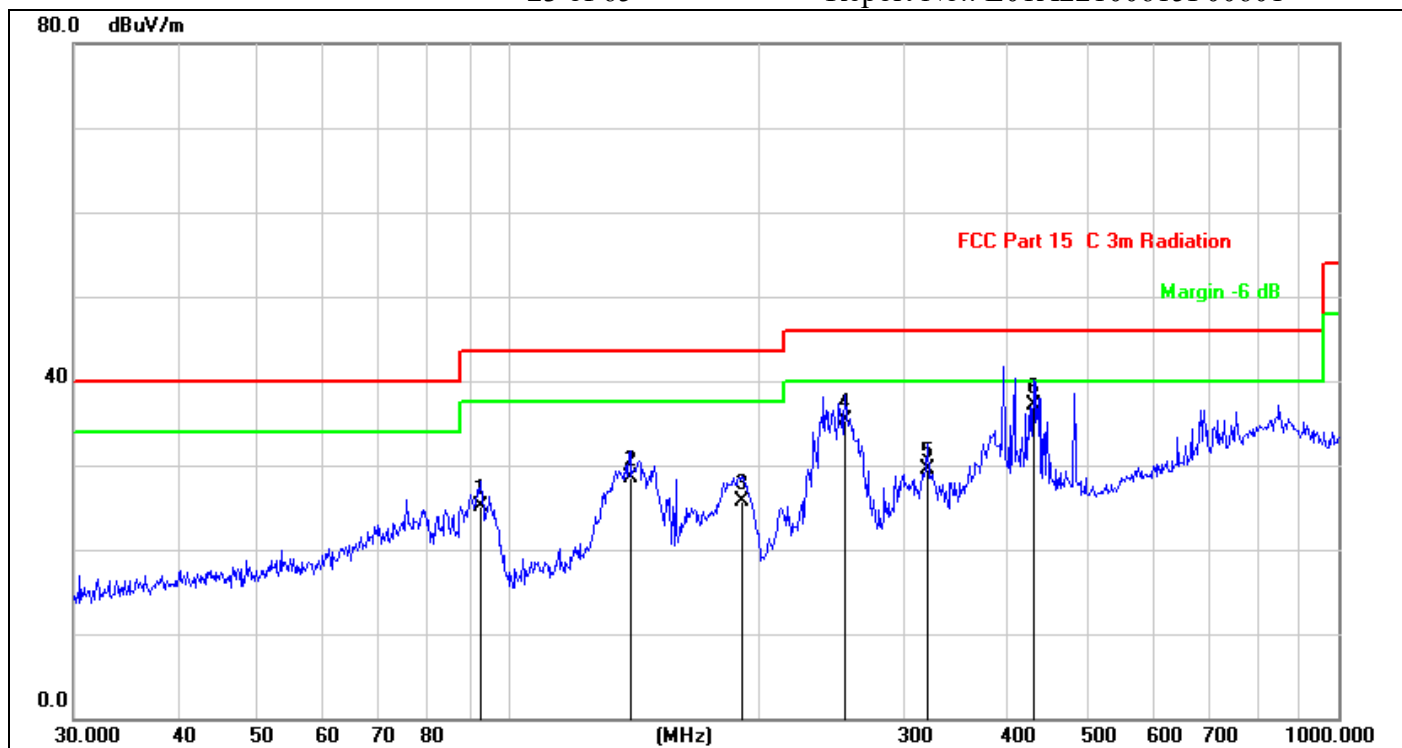

<b>Site:</b>	LAB	<b>Antenna::</b>	Horizontal	<b>Temperature(C):</b>	26(C)
<b>Limit:</b>	FCC Part 15 C 3m Radiation	<b>Test Time:</b>		<b>Humidity(%):</b>	60%
<b>EUT:</b>	Motorized Penis Stroking Machine With Insertable Sleeve	<b>Power Rating:</b>		<b>2022-11-15</b>	
<b>M/N.:</b>	Autoblow AI+	<b>Test Engineer:</b>			
<b>Mode:</b>	TX2412				
<b>Note:</b>	Adapter: GQ36-120300-AX				

No.	Frequency (MHz)	Reading (dBuV)	Factor (dB/m)	Level (dBuV/m)	Limit (dBuV/m)	Margin (dB)	Det.	Remark
1	92.7871	37.93	-12.75	25.18	43.50	-18.32	QP	
2	140.3421	40.46	-11.86	28.60	43.50	-14.90	QP	
3	191.0738	36.97	-11.23	25.74	43.50	-17.76	QP	
4	254.7284	44.38	-9.07	35.31	46.00	-10.69	QP	
5	319.9370	36.13	-6.57	29.56	46.00	-16.44	QP	
6 *	429.5228	39.09	-2.07	37.02	46.00	-8.98	QP	

Note: 1. Result Level = Read Level+ Antenna Factor+ Cable Loss- Amp. Factor



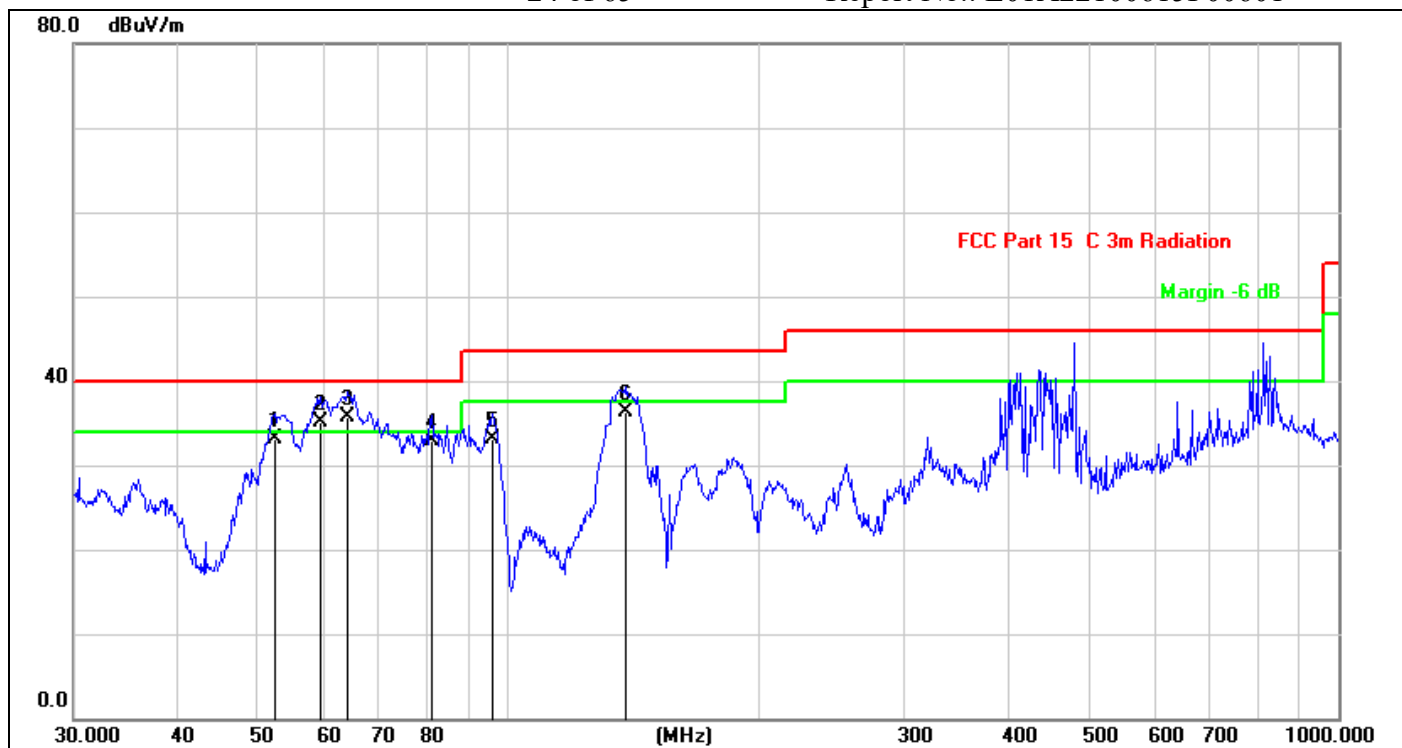

<b>Site:</b>	LAB	<b>Antenna::</b>	Vertical	<b>Temperature(C):</b>	26(C)
<b>Limit:</b>	FCC Part 15 C 3m Radiation	<b>Humidity(%):</b>	60%	<b>Test Time:</b>	2022-11-15
<b>EUT:</b>	Motorized Penis Stroking Machine With Insertable Sleeve	<b>Power Rating:</b>	AC 120V/60Hz	<b>Test Engineer:</b>	Sunshine
<b>M/N.:</b>	Autoblow AI+				
<b>Mode:</b>	TX2412				
<b>Note:</b>	Adapter: GQ36-120300-AX				

No.	Frequency (MHz)	Reading (dBuV)	Factor (dB/m)	Level (dBuV/m)	Limit (dBuV/m)	Margin (dB)	Det.	Remark
1	52.3912	42.31	-9.28	33.03	40.00	-6.97	QP	
2 !	59.4405	44.20	-9.04	35.16	40.00	-4.84	QP	
3 *	63.9828	44.74	-9.12	35.62	40.00	-4.38	QP	
4	80.9275	45.42	-12.46	32.96	40.00	-7.04	QP	
5	95.7622	45.12	-12.04	33.08	43.50	-10.42	QP	
6	138.8735	48.26	-11.99	36.27	43.50	-7.23	QP	

Note: 1. Result Level = Read Level+ Antenna Factor+ Cable Loss- Amp. Factor



<b>Site:</b>	LAB	<b>Antenna::</b>	Horizontal	<b>Temperature(C):</b>	26(C)
<b>Limit:</b>	FCC Part 15 C 3m Radiation	<b>Test Time:</b>		<b>Humidity(%):</b>	60%
<b>EUT:</b>	Motorized Penis Stroking Machine With Insettable Sleeve	<b>Power Rating:</b>		<b>Test Engineer:</b>	Sunshine
<b>M/N.:</b>	Autoblow AI+				
<b>Mode:</b>	TX2412				
<b>Note:</b>	Adapter: LY036SPS-120300U1				

No.	Frequency (MHz)	Reading (dBuV)	Factor (dB/m)	Level (dBuV/m)	Limit (dBuV/m)	Margin (dB)	Det.	Remark
1	95.4270	50.53	-31.63	18.90	43.50	-24.60	QP	
2	120.6991	49.62	-31.32	18.30	43.50	-25.20	QP	
3	247.6819	57.12	-31.82	25.30	46.00	-20.70	QP	
4	280.0237	58.39	-31.79	26.60	46.00	-19.40	QP	
5	313.2760	59.76	-31.66	28.10	46.00	-17.90	QP	
6 *	340.7817	62.12	-31.42	30.70	46.00	-15.30	QP	

Note: 1. Result Level = Read Level+ Antenna Factor+ Cable Loss- Amp. Factor

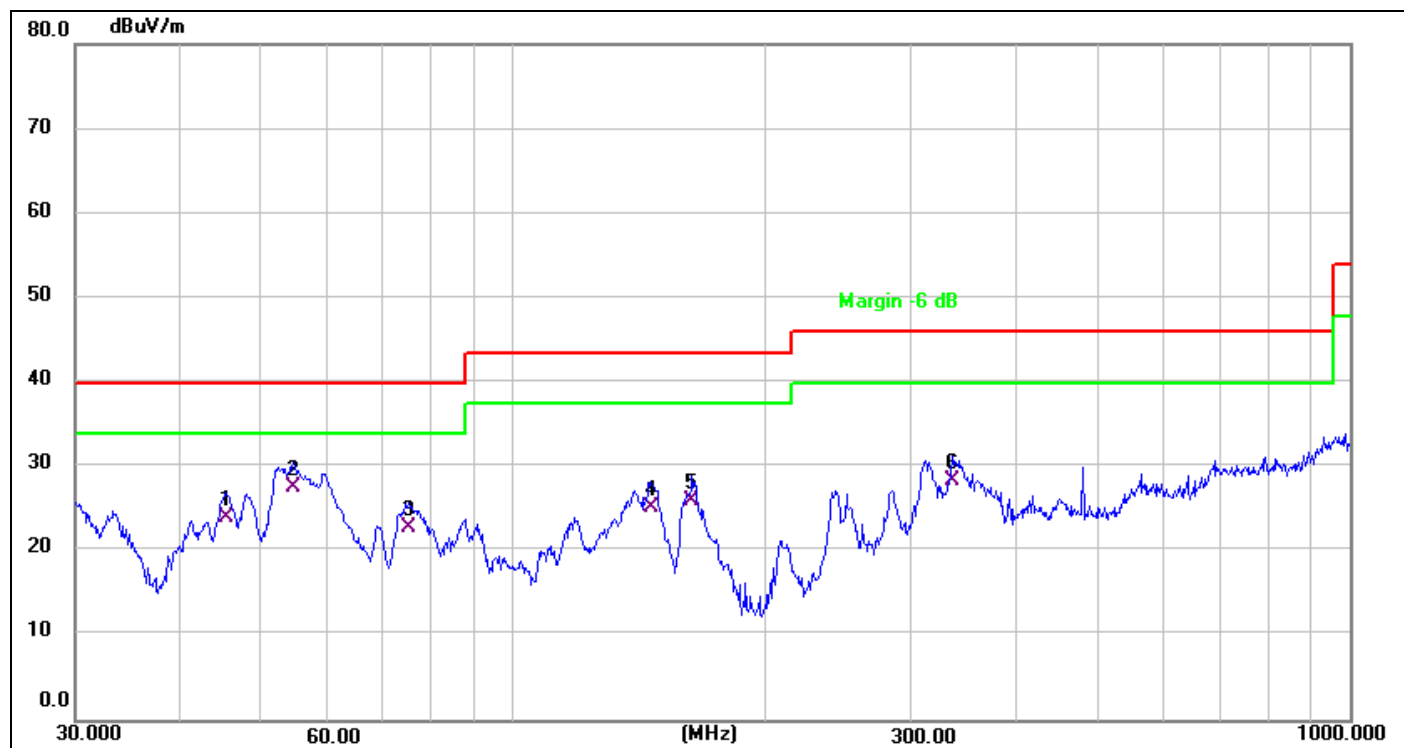

<b>Site:</b>	LAB	<b>Antenna::</b>	Vertical	<b>Temperature(C):</b>	26(C)
<b>Limit:</b>	FCC Part 15 C 3m Radiation			<b>Humidity(%):</b>	60%
<b>EUT:</b>	Motorized Penis Stroking Machine With Insertable Sleeve	<b>Test Time:</b>		<b>2022-11-15</b>	
<b>M/N.:</b>	Autoblow AI+	<b>Power Rating:</b>		<b>AC 120V/60Hz</b>	
<b>Mode:</b>	TX2412	<b>Test Engineer:</b>		<b>Sunshine</b>	
<b>Note:</b>	<b>Adapter: LY036SPS-120300U1</b>				

No.	Frequency (MHz)	Reading (dBuV)	Factor (dB/m)	Level (dBuV/m)	Limit (dBuV/m)	Margin (dB)	Det.	Remark
1	45.5348	41.36	-17.26	24.10	40.00	-15.90	QP	
2 *	54.6429	58.72	-31.12	27.60	40.00	-12.40	QP	
3	75.1822	54.63	-31.83	22.80	40.00	-17.20	QP	
4	146.3735	56.85	-31.55	25.30	43.50	-18.20	QP	
5	163.7550	57.80	-31.70	26.10	43.50	-17.40	QP	
6	334.8589	59.98	-31.48	28.50	46.00	-17.50	QP	

Note: 1. Result Level = Read Level+ Antenna Factor+ Cable Loss- Amp. Factor

**Above 1GHz:**

All the modulation modes were tested the data of the worst mode (TX 802.11b) are recorded in the following pages and the others modulation methods do not exceed the limits. The frequency range from 1GHz to 25GHz is investigated.

Operation Mode: 802.11b Lowest      Test Date : 2022-11-15  
 Test Voltage: AC 120V/60Hz      Test by: Big

Freq. (MHz)	Ant. Pol. H/V	Emission Level(dBuV/m)		Limit 3m(dBuV/m)		Over(dB)	
		PK	AV	PK	AV	PK	AV
4824	V	63.85	43.54	74	54	-10.15	-10.46
7236	V	63.97	42.15	74	54	-10.03	-11.85
9648	V	62.15	43.05	74	54	-11.85	-10.95
12060	V	62.64	44.15	74	54	-11.36	-9.85
14472	V	63.05	40.36	74	54	-10.95	-13.64
16884	V	63.15	41.55	74	54	-10.85	-12.45
4824	H	62.78	42.19	74	54	-11.22	-11.81
7236	H	62.64	42.64	74	54	-11.36	-11.36
9648	H	61.45	42.87	74	54	-12.55	-11.13
12060	H	60.69	42.63	74	54	-13.31	-11.37
14472	H	60.12	41.45	74	54	-13.88	-12.55
16884	H	59.88	40.32	74	54	-14.12	-13.68

Operation Mode: 802.11b Middle      Test Date : 2022-11-15  
 Test Voltage: AC 120V/60Hz      Test by: Big

Freq. (MHz)	Ant. Pol. H/V	Emission Level(dBuV/m)		Limit 3m(dBuV/m)		Over(dB)	
		PK	AV	PK	AV	PK	AV
4874	V	64.15	44.12	74	54	-9.85	-9.88
7311	V	62.15	43.64	74	54	-11.85	-10.36
9688	V	62.35	43.15	74	54	-11.65	-10.85
12185	V	63.87	43.05	74	54	-10.13	-10.95
14622	V	63.46	43.19	74	54	-10.54	-10.81
17059	V	62.59	42.64	74	54	-11.41	-11.36
4874	H	63.05	42.54	74	54	-10.95	-11.46
7311	H	61.11	41.78	74	54	-12.89	-12.22
9688	H	62.15	41.97	74	54	-11.85	-12.03
12185	H	63.05	40.52	74	54	-10.95	-13.48
14622	H	61.59	40.69	74	54	-12.41	-13.31
17059	H	60.96	39.87	74	54	-13.04	-14.13

Operation Mode: 802.11b Highest

Test Date : 2022-11-15

Test Voltage: AC 120V/60Hz

Test by: Big

Freq. (MHz)	Ant. Pol. H/V	Emission Level(dBuV/m)		Limit 3m(dBuV/m)		Over(dB)	
		PK	AV	PK	AV	PK	AV
4924	V	63.88	44.87	74	54	-10.12	-9.13
7386	V	63.54	43.64	74	54	-10.46	-10.36
9848	V	63.12	42.15	74	54	-10.88	-11.85
12310	V	62.69	42.85	74	54	-11.31	-11.15
14772	V	62.36	43.05	74	54	-11.64	-10.95
17234	V	62.54	43.16	74	54	-11.46	-10.84
4924	H	64.42	42.57	74	54	-9.58	-11.43
7386	H	63.58	42.55	74	54	-10.42	-11.45
9848	H	62.49	41.77	74	54	-11.51	-12.23
12310	H	61.33	40.28	74	54	-12.67	-13.72
14772	H	61.39	38.95	74	54	-12.61	-15.05
17234	H	60.25	39.16	74	54	-13.75	-14.84

**All emissions not reported were more than 20dB below the specified limit or in the noise floor.**

**No others harmonics emissions are higher than 20 dB below the limits of 47 CFR Part 15.247.**

- Note:**
- (1) All Readings are Peak Value and AV.
  - (2) Emission Level= Reading Level+Probe Factor +Cable Loss.
  - (3) Data of measurement within this frequency range shown “ – ” in the table above means the reading of emissions are attenuated more than 20dB below the permissible limits or the field strength is too small to be measured.

## 8. 6dB Bandwidth Test

### 8.1 Measurement Procedure

The EUT was operating in IEEE 802.11b, 802.11g, 802.11n(HT20) mode or could be controlled its channel. Printed out the test result from the spectrum by hard copy function. The testing follows the Measurement Procedure of FCC KDB No. 558074 D01 15.247 Meas Guidance v05r02 .

1. Set resolution bandwidth (RBW) = 100 kHz.
2. Set the video bandwidth (VBW)  $\geq 3 \times$  RBW.
3. Detector = Peak.
4. Trace mode = max hold.
5. Sweep = auto couple.
6. Allow the trace to stabilize.
7. Measure the maximum width of the emission that is constrained by the frequencies associated with the two outermost amplitude points (upper and lower frequency) that are attenuated by 6 dB relative to the maximum level measured in the fundamental emission.

### 8.2 Test SET-UP (Block Diagram of Configuration)

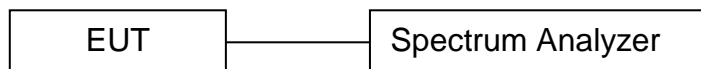

### 8.3 Measurement Equipment Used

EQUIPMENT TYPE	MFR	MODEL NUMBER	SERIAL NUMBER	CALIBRATED UNTIL
Spectrum Analyzer	Rohde & Schwarz	FSV40	US40240623	2023-10-28
Coaxial Cable	Gigalink Microwave	ZT40	19022092	2023-10-28
Antenna Connector	ARTHUR-YANG	2244-N1TG1	N/A	2023-10-28

**Remark: The temporary antenna connector is soldered on the PCB board in order to perform conducted tests and this temporary antenna connector is listed in the equipment list.**

### 8.4 Measurement Results

6db Bandwidth Test Data Chart:

Refer to attached data chart.

Spectrum Detector: PK  
 Test By: Big  
 Humidity : 60%

Test Date : 2022-11-17  
 Temperature : 26°C

Mode	Frequency (MHz)	Antenna	-6 dB Bandwidth (MHz)	Limit -6 dB Bandwidth (MHz)	Verdict
b	2412	Ant1	10.056	0.5	Pass
b	2437	Ant1	10.017	0.5	Pass
b	2462	Ant1	10.035	0.5	Pass
g	2412	Ant1	16.302	0.5	Pass
g	2437	Ant1	16.266	0.5	Pass
g	2462	Ant1	16.344	0.5	Pass
n20	2412	Ant1	16.563	0.5	Pass
n20	2437	Ant1	16.53	0.5	Pass
n20	2462	Ant1	16.929	0.5	Pass

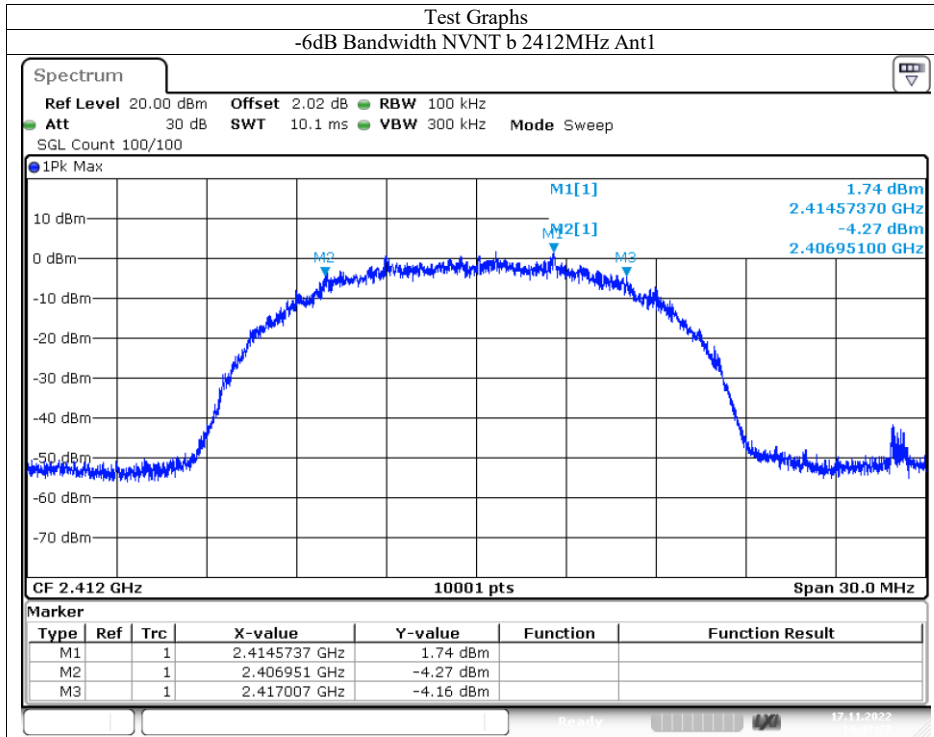

Date: 17.NOV.2022 14:47:27

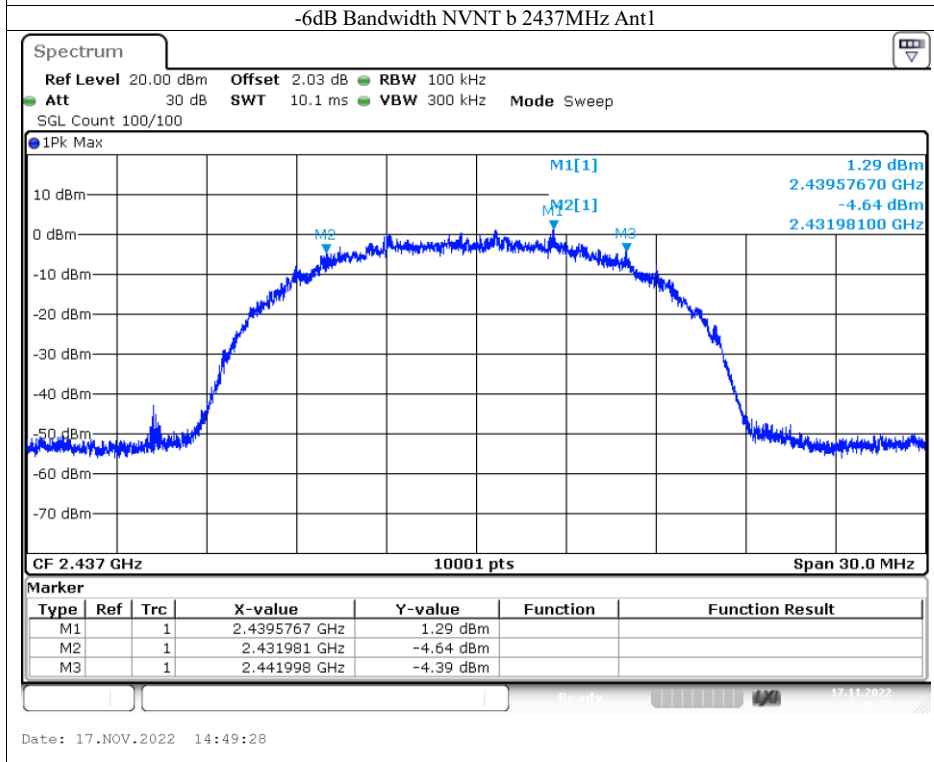

Date: 17.NOV.2022 14:49:28



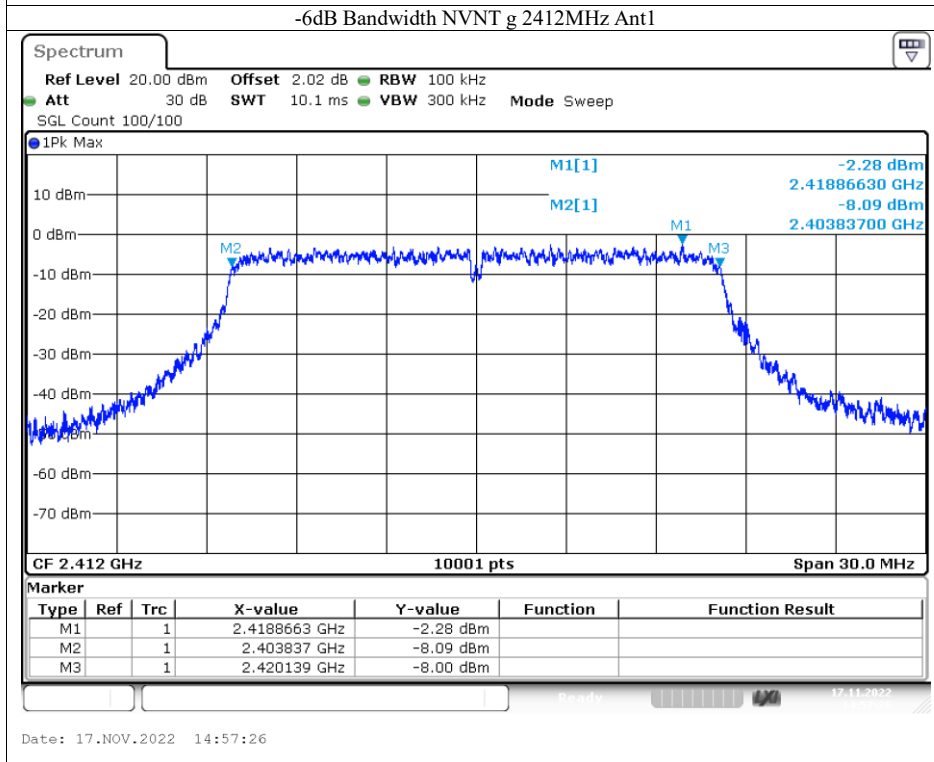
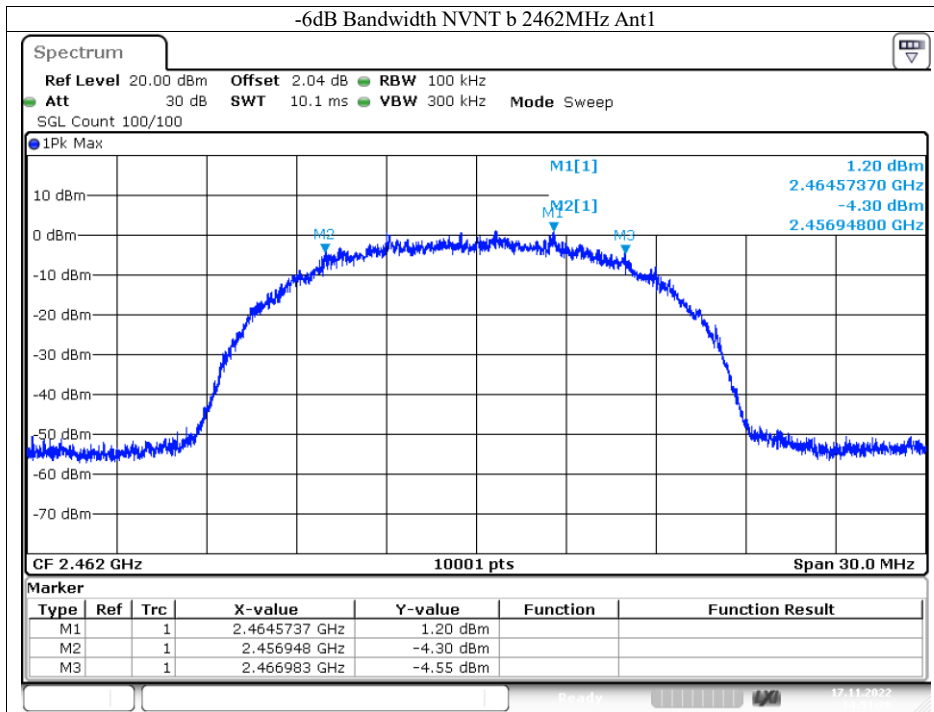

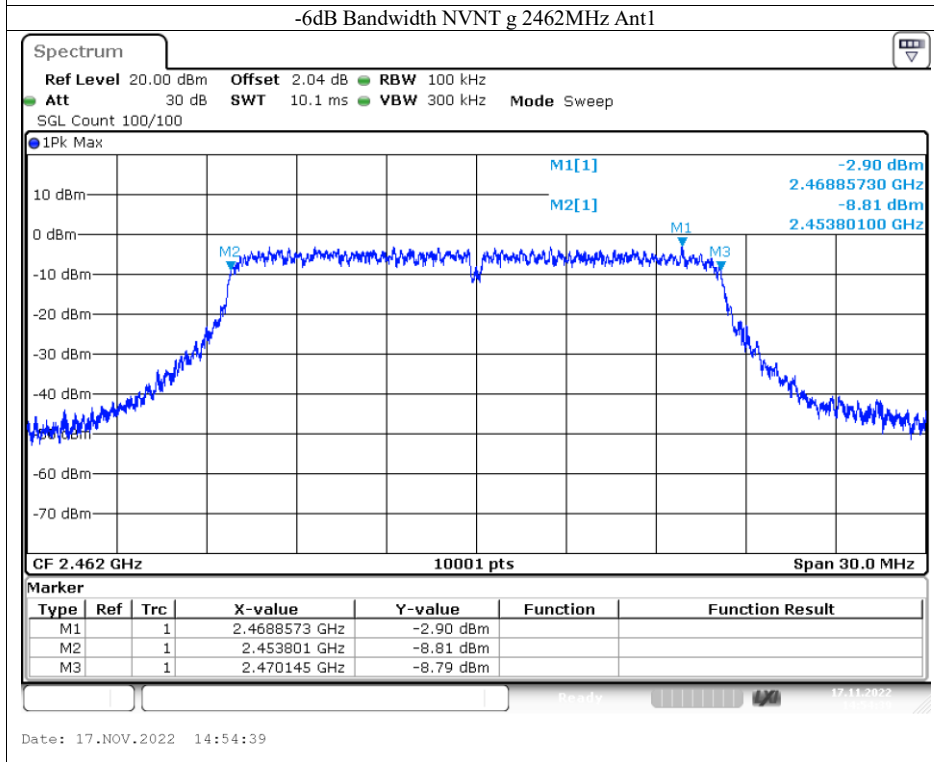
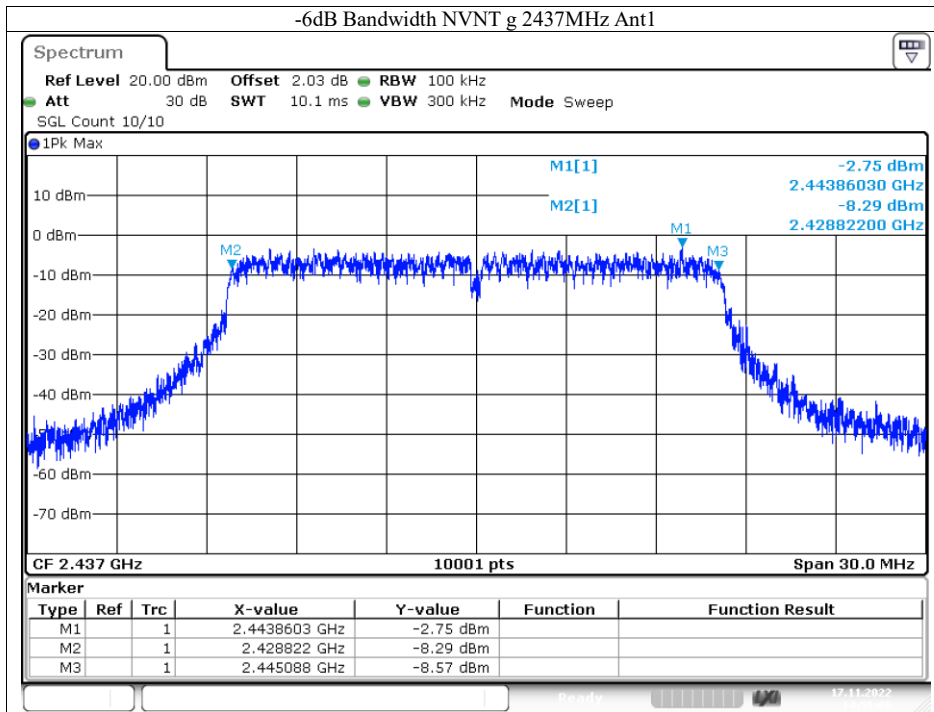

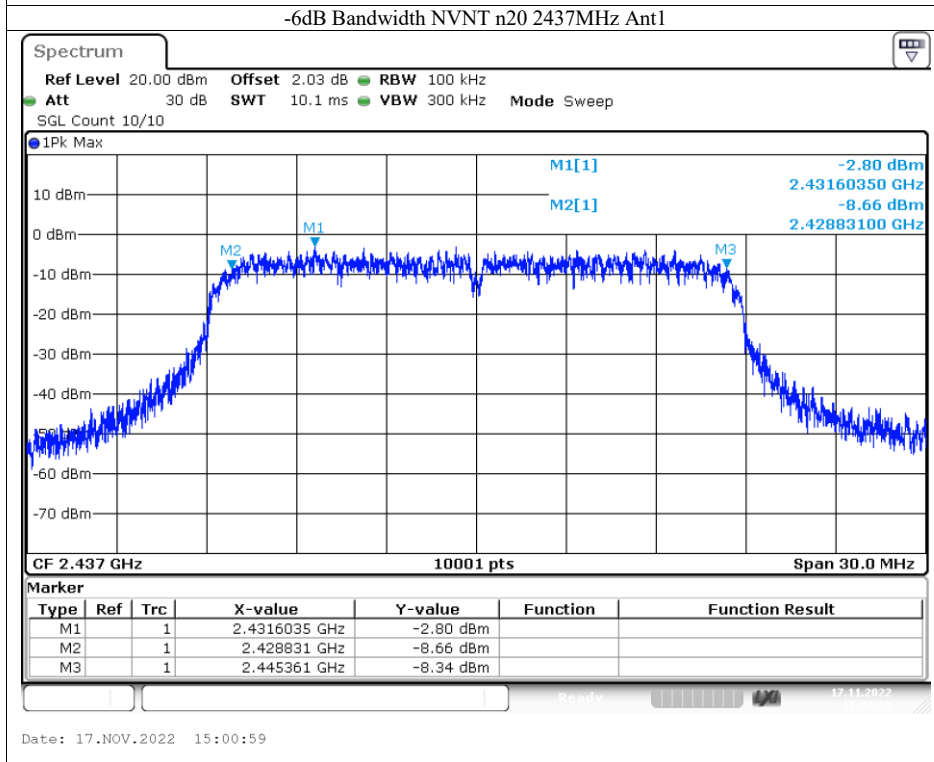
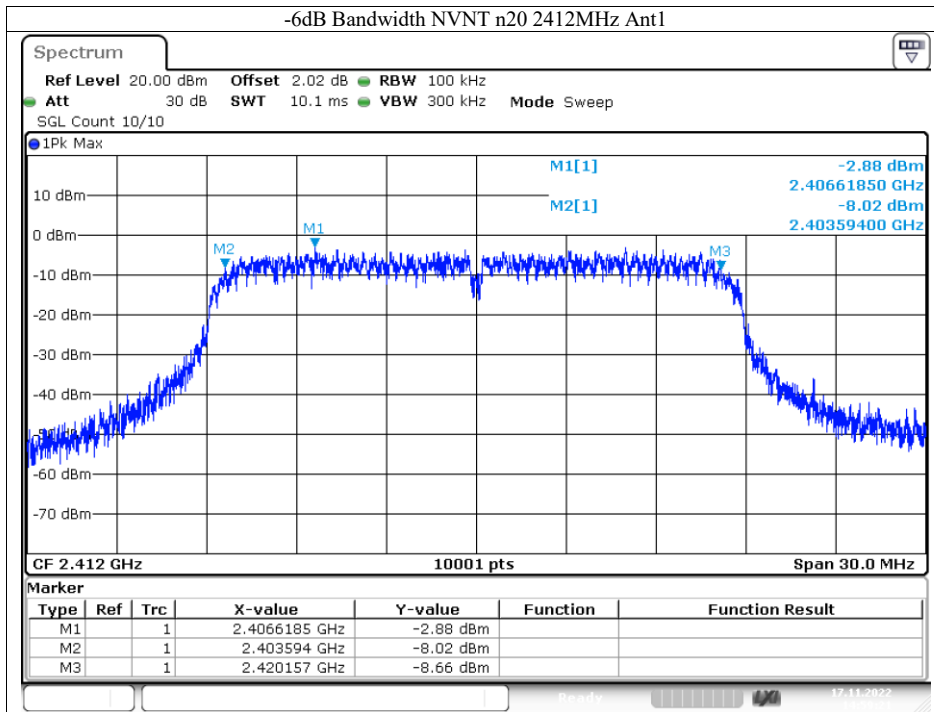



## 9. Maximum Peak Output Power Test

### 9.1 Measurement Procedure

1. The testing follows the Measurement Procedure of FCC KDB No. 558074 D01 15.247 Meas Guidance v05r02. The RF output of EUT was connected to the power meter by RF cable and attenuator. The path loss was compensated to the results for each measurement.
2. Set to the maximum power setting and enable the EUT transmit continuously.
3. Measure the conducted output power and record the results in the test report.

### 9.2 Test SET-UP (Block Diagram of Configuration)



### 9.3 Measurement Equipment Used

EQUIPMENT TYPE	Manufacturer	Model No.	Serial Number	Calibrated until.
USB RF Power sensor	RadiPower	RPR3006W	17I00015SNO88	2023-10-28
RF Test Software	MAIWEI	MTS 8310	N/A	N/A

Remark: The temporary antenna connector is soldered on the PCB board in order to perform conducted tests and this temporary antenna connector is listed in the equipment list.

### 9.4 Peak Power output limit

The maximum peak power shall be less 1Watt.

### 9.5 Measurement Results

Spectrum Detector: PK                      Test Date : 2022-11-17  
 Test By: Big                                  Temperature : 26°C  
 Test Result: PASS                          Humidity : 60%

Test Channel	Peak Output Power (dBm)			Limit(dBm)	Result
	802.11b	802.11g	802.11n(HT20)		
Lowest	6.45	6.32	6.09	30	Pass
Middle	6.14	6.28	6.18		
Highest	6.19	6.47	6.27		

## 10. Band Edge Test

### 10.1 Measurement Procedure

#### For Conducted Test

1. The testing follows FCC KDB Publication No. 5558074 D01 15.247 Meas Guidance v05r02.
2. The RF output of EUT was connected to the spectrum analyzer by RF cable and attenuator. The path loss was compensated to the results for each measurement.
3. Set to the maximum power setting and enable the EUT transmit continuously.
4. Set RBW = 100 kHz, VBW=300 kHz, Peak Detector. Unwanted Emissions measured in any 100 kHz bandwidth outside of the authorized frequency band shall be attenuated by at least 20 dB relative to the maximum in-band peak PSD level in 100 kHz when maximum peak conducted output power procedure is used. Measure and record the results in the test report.
5. The RF fundamental frequency should be excluded against the limit line in the operating frequency band.

#### For Radiated emission Test

1. The testing follows FCC KDB Publication No. 5558074 D01 15.247 Meas Guidance v05r02.
2. The EUT was arranged to its worst case and then tune the antenna tower (from 1 m to 4 m) and turntable (from 0 degree to 360 degrees) to find the maximum reading. A pre-amp and a high pass filter are used for the test in order to get better signal level.
3. The EUT was placed on a turntable with 0.8 meter above ground.
4. The EUT was set 3 meters from the interference receiving antenna, which was mounted on the top of a variable height antenna tower.
5. Corrected Reading: Antenna Factor + Cable Loss + Read Level - Preamp Factor = Level.
6. For measurement below 1GHz, If the emission level of the EUT measured by the peak detector is 3 dB lower than the applicable limit, the peak emission level will be reported. Otherwise, the emission measurement will be repeated using the quasi-peak detector and reported.
7. Repeat above procedures until all frequency measured were complete.

When spectrum scanned above 1GHz setting resolution bandwidth 1MHz, video bandwidth 3MHz.

EMI Test Receiver	Setting
Attenuation	Auto
RB	1MHz
VB	3MHz
Detector	Peak
Trace	Max hold

When spectrum scanned above 1GHz setting resolution bandwidth 1MHz, video bandwidth 10Hz.

EMI Test Receiver	Setting
Attenuation	Auto
RB	1MHz
VB	10Hz
Detector	AVG
Trace	Max hold

## 10.2 Test SET-UP (Block Diagram of Configuration)

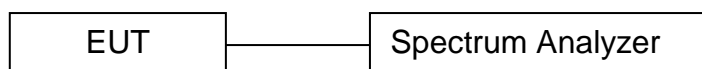

## 10.3 Measurement Equipment Used

EQUIPMENT TYPE	MFR	MODEL NUMBER	SERIAL NUMBER	CALIBRATED UNTIL
Spectrum Analyzer	Rohde & Schwarz	FSV40	US40240623	2023-10-28
Coaxial Cable	Gigalink Microwave	ZT40	19022092	2023-10-28
Antenna Connector	ARTHUR-YANG	2244-N1TG1	N/A	2023-10-28

**Remark: The temporary antenna connector is soldered on the PCB board in order to perform conducted tests and this temporary antenna connector is listed in the equipment list.**

## 10.4 Measurement Results

### 1. Conducted Test

Please refer to the following pages.

Spectrum Detector:	PK	Test Date :	2022-11-17
Test By:	Big	Temperature :	26°C
Test Result:	PASS	Humidity :	60%

Mode	Frequency (MHz)	Antenna	Max Value (dBc)	Limit (dBc)	Verdict
b	2412	Ant1	-52.56	-20	Pass
b	2462	Ant1	-55.88	-20	Pass
g	2412	Ant1	-43.76	-20	Pass
g	2462	Ant1	-51.99	-20	Pass
n20	2412	Ant1	-42.88	-20	Pass
n20	2462	Ant1	-51.7	-20	Pass

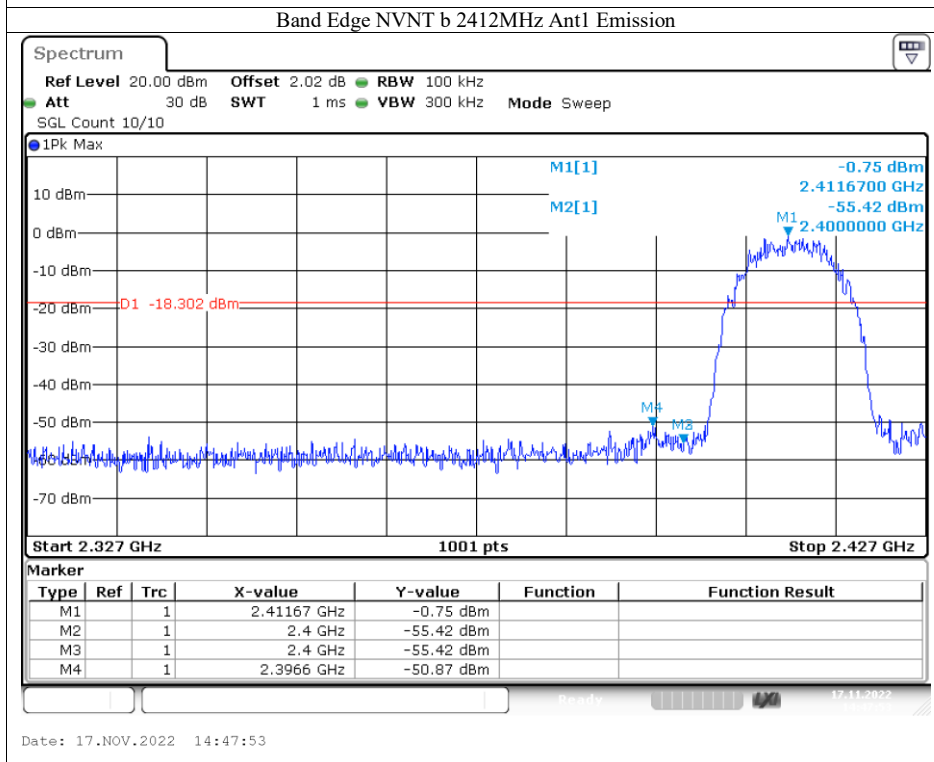
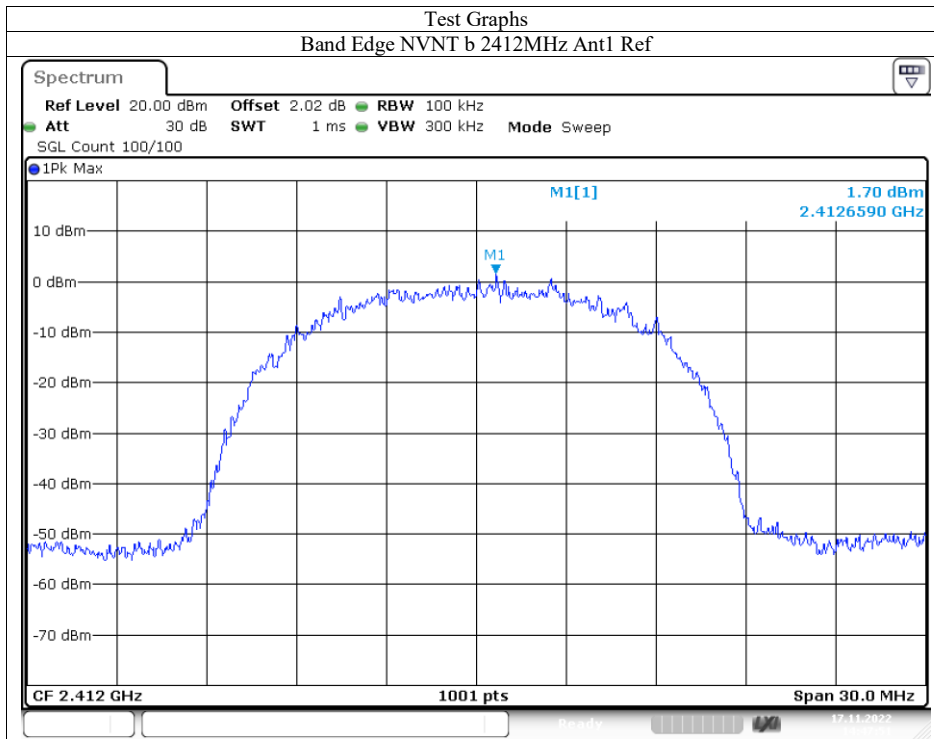



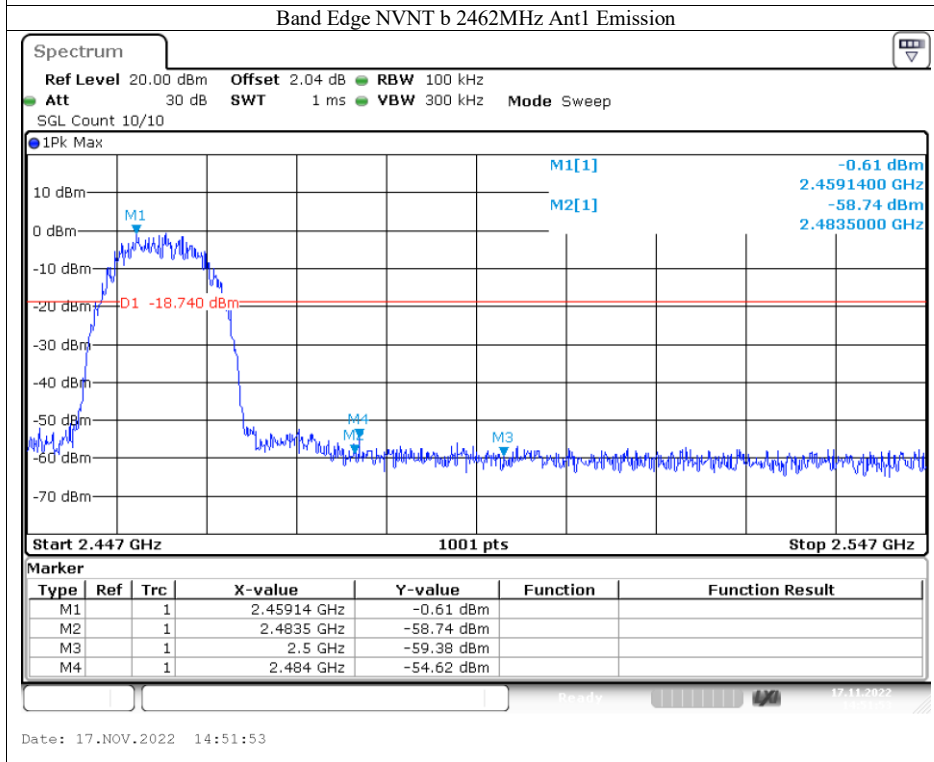
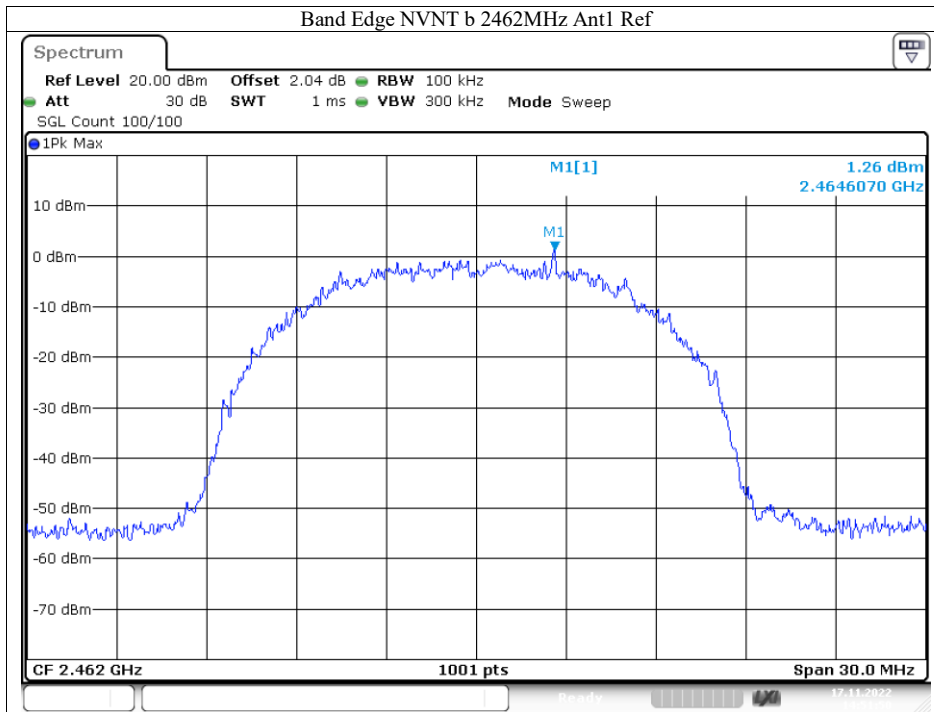

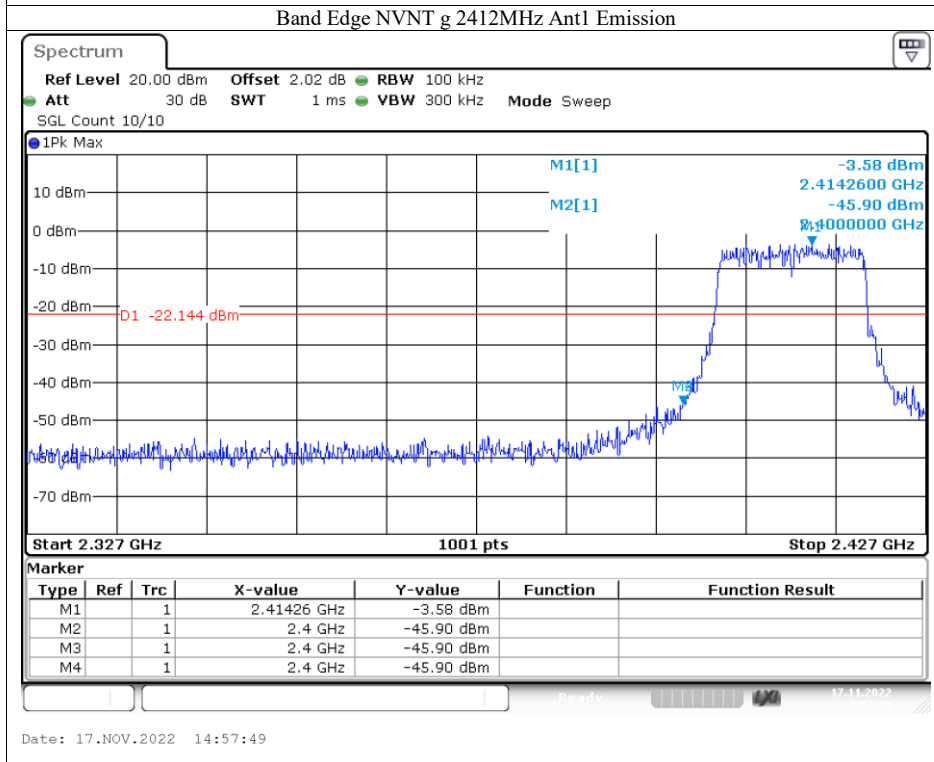
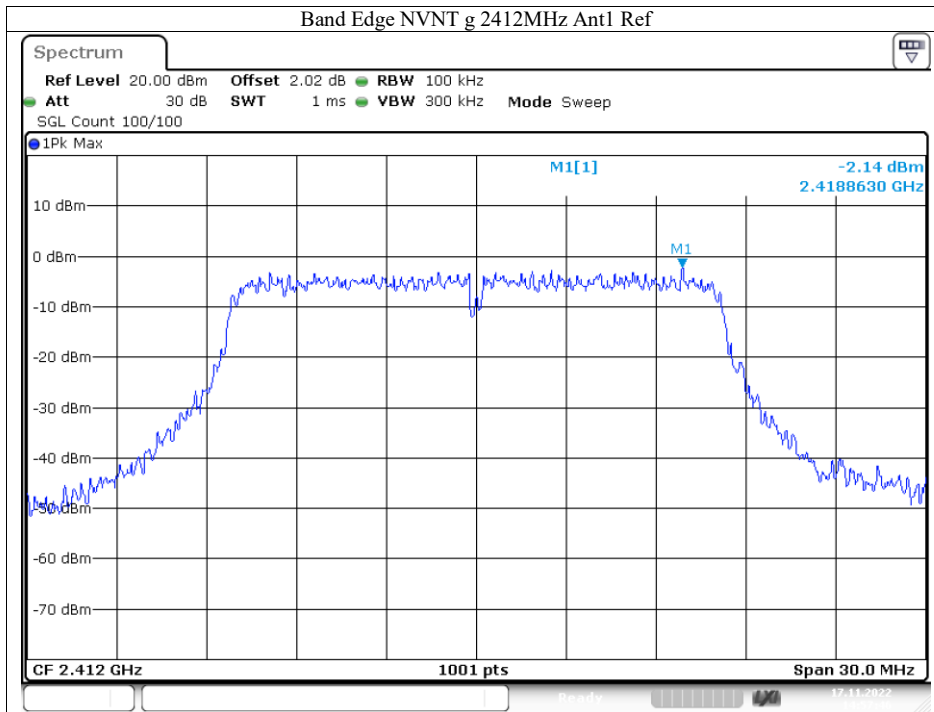

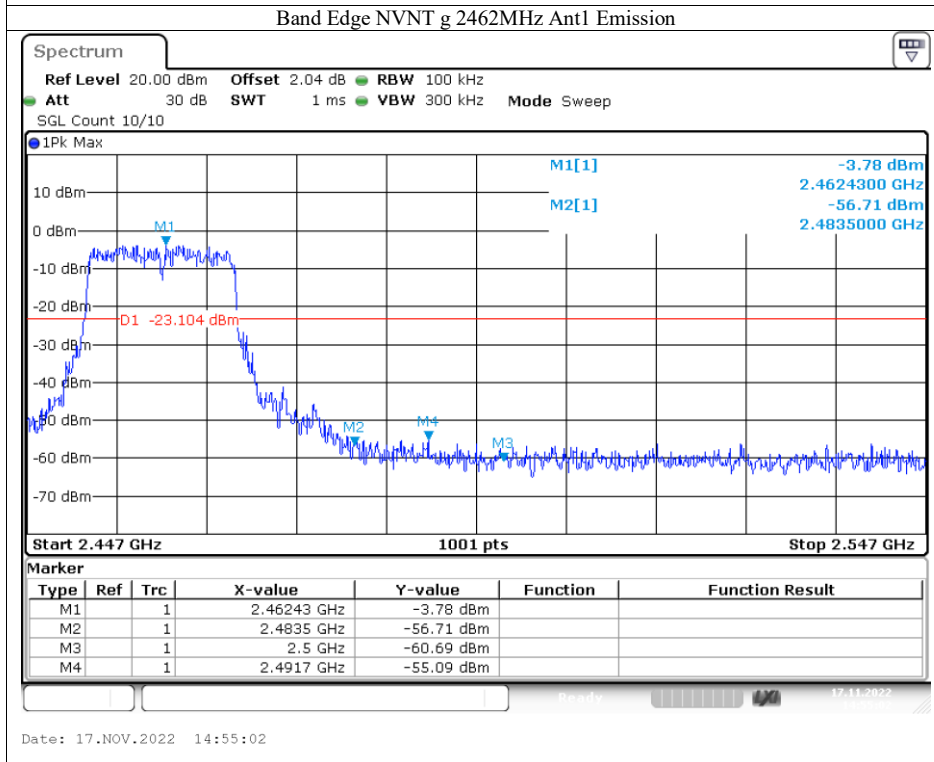
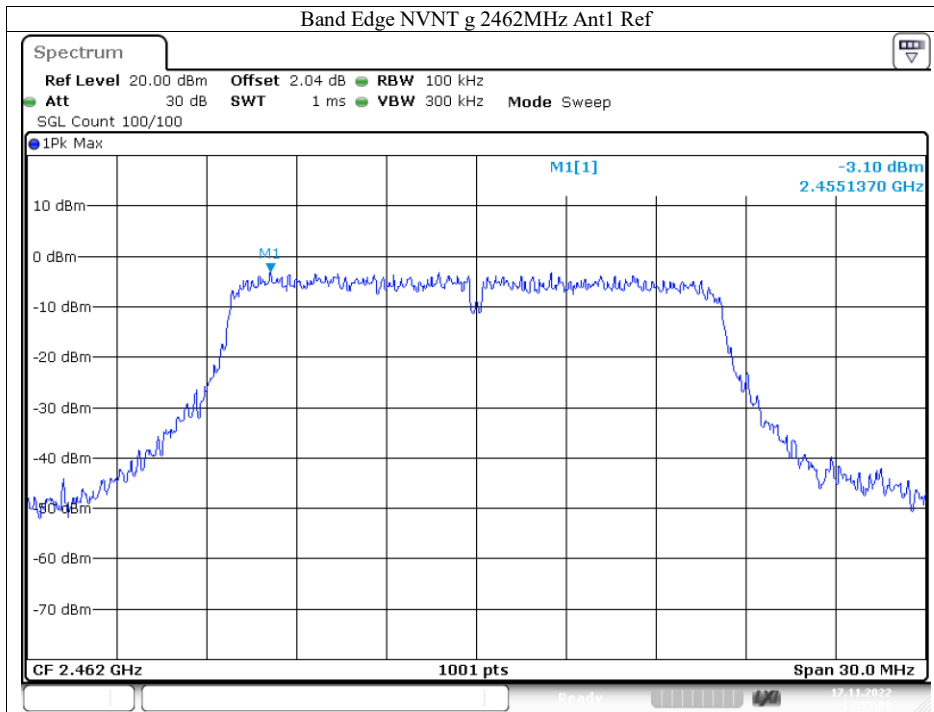

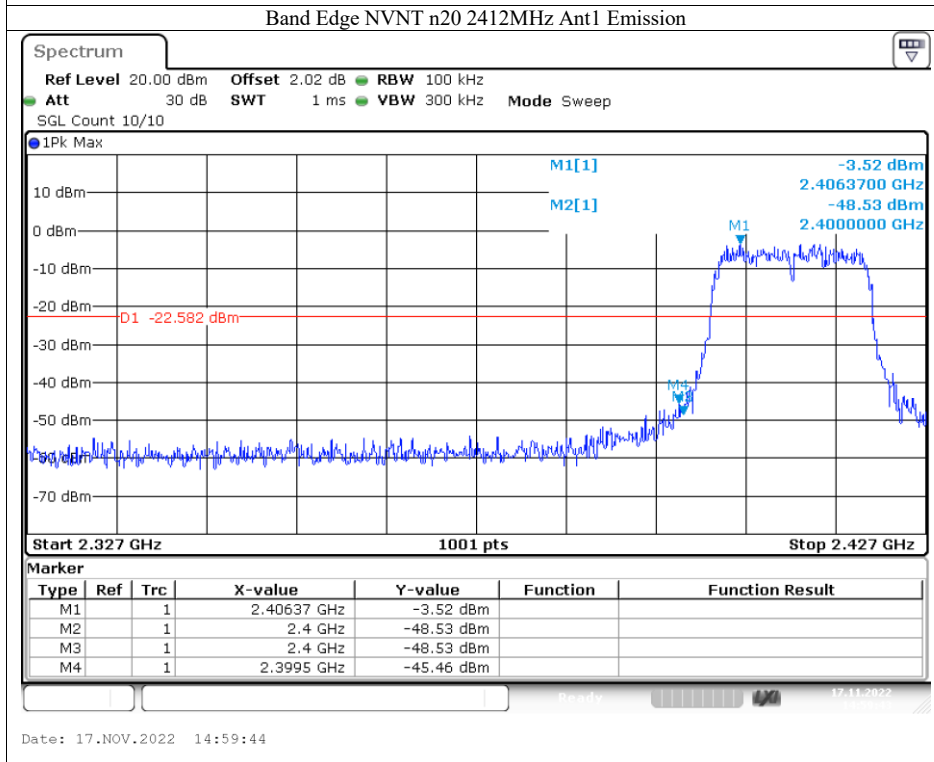
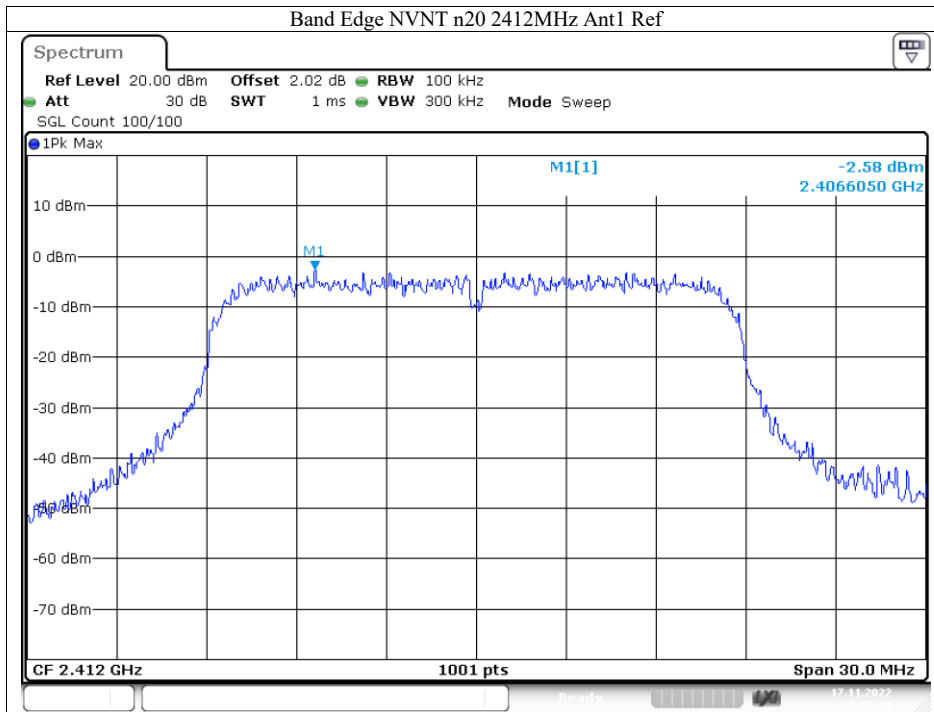

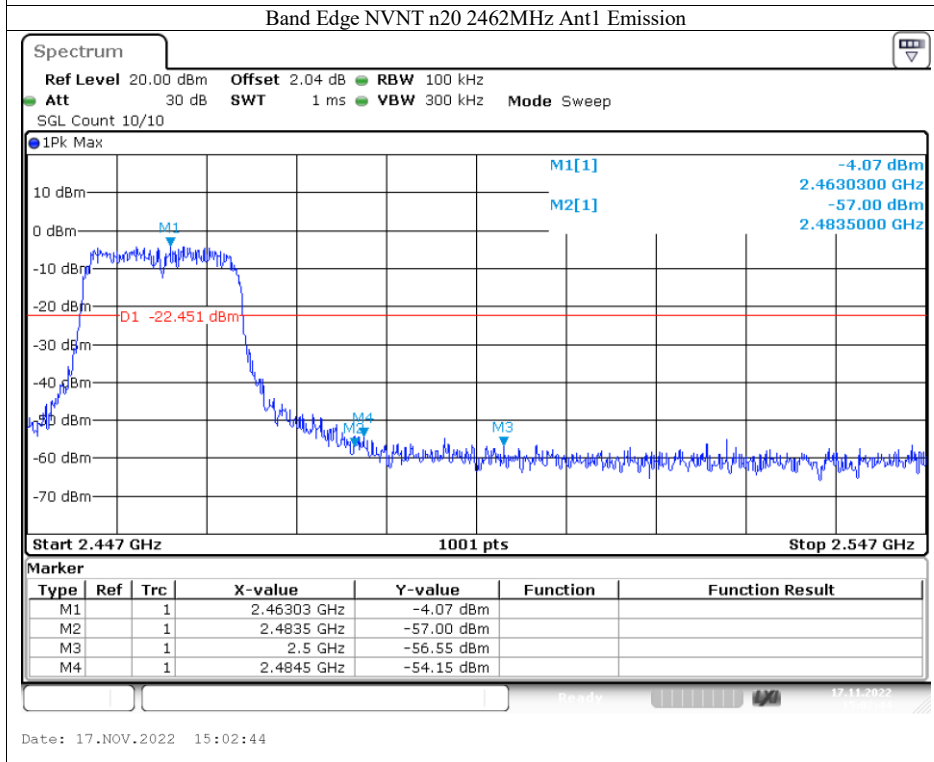
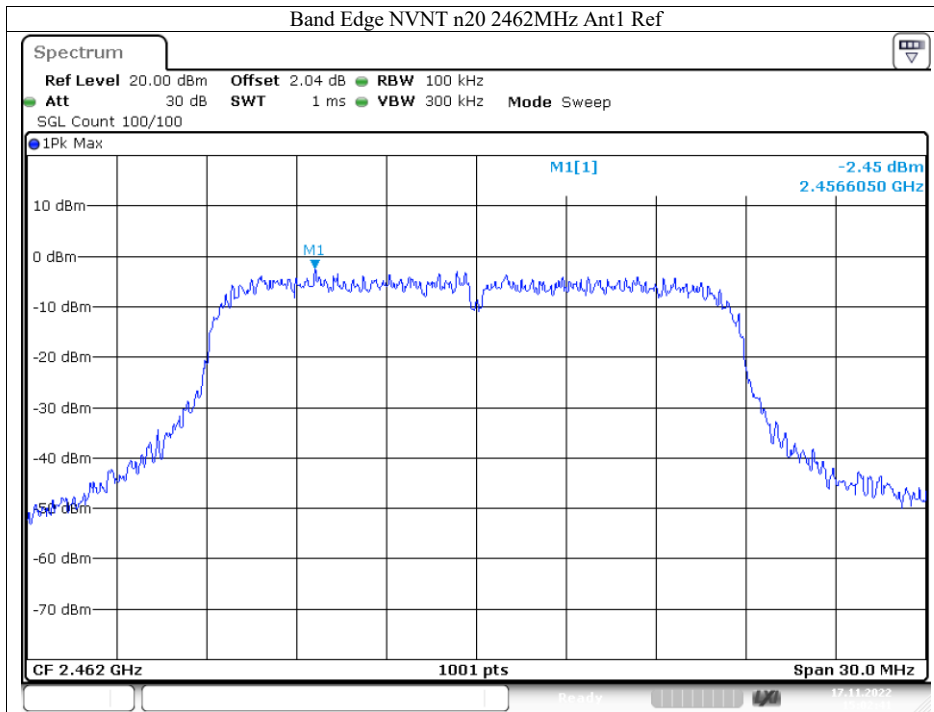

## 2. Radiated emission Test

Spectrum Detector:

PK/AV

Test Date :

2022-11-15

Test By:

Big

Temperature :

28 °C

Humidity :

65 %

IEEE 802.11b SISO										
Freq. (MHz)	Ant. Pol.	Reading Level(dBuV/m)		Correct Factor dB	Emission Level(dBuV/m)		Limit 3m(dBuV/m)		Margin(dB)	
		PK	AV		PK	AV	PK	AV	PK	AV
<2400	H	86.65	68.41	-26.3	60.35	42.11	74	54	-13.65	-11.89
<2400	V	85.65	65.59	-26.1	59.55	39.49	74	54	-14.45	-14.51
>2483.5	H	88.09	67.52	-26.3	61.79	41.22	74	54	-12.21	-12.78
>2483.5	V	86.46	65.18	-26.1	60.36	39.08	74	54	-13.64	-14.92

IEEE 802.11g SISO										
Freq. (MHz)	Ant. Pol.	Reading Level(dBuV/m)		Correct Factor dB	Emission Level(dBuV/m)		Limit 3m(dBuV/m)		Margin(dB)	
		PK	AV		PK	AV	PK	AV	PK	AV
<2400	H	90.45	70.55	-26.3	64.15	44.25	74	54	-9.85	-9.75
<2400	V	86.79	66.79	-26.1	60.69	40.69	74	54	-13.31	-13.31
>2483.5	H	87.89	67.78	-26.3	61.59	41.48	74	54	-12.41	-12.52
>2483.5	V	86.43	68.89	-26.1	60.33	42.79	74	54	-13.67	-11.21

IEEE 802.11n(HT20) SISO										
Freq. (MHz)	Ant. Pol.	Reading Level(dBuV/m)		Correct Factor dB	Emission Level(dBuV/m)		Limit 3m(dBuV/m)		Margin(dB)	
		PK	AV		PK	AV	PK	AV	PK	AV
<2400	H	89.27	70.32	-26.3	62.97	44.02	74	54	-11.03	-9.98
<2400	V	86.21	68.25	-26.1	60.11	42.15	74	54	-13.89	-11.85
>2483.5	H	88.76	68.64	-26.3	62.46	42.34	74	54	-11.54	-11.66
>2483.5	V	87.46	67.74	-26.1	61.36	41.64	74	54	-12.64	-12.36

IEEE 802.11n(HT40) SISO										
Freq. (MHz)	Ant. Pol.	Reading Level(dBuV/m)		Correct Factor dB	Emission Level(dBuV/m)		Limit 3m(dBuV/m)		Margin(dB)	
		PK	AV		PK	AV	PK	AV	PK	AV
<2400	H	89.99	69.84	-26.3	63.69	43.54	74	54	-10.31	-10.46
<2400	V	86.26	68.21	-26.1	60.16	42.11	74	54	-13.84	-11.89
>2483.5	H	87.25	66.99	-26.3	60.95	40.69	74	54	-13.05	-13.31
>2483.5	V	85.98	66.35	-26.1	59.88	40.25	74	54	-14.12	-13.75

## 11. Power Density

### 11.1 Test Equipment

EQUIPMENT TYPE	MFR	MODEL NUMBER	SERIAL NUMBER	CALIBRATED UNTIL
Spectrum Analyzer	Rohde & Schwarz	FSV40	US40240623	2023-10-28
Coaxial Cable	Gigalink Microwave	ZT40	19022092	2023-10-28
Antenna Connector	ARTHUR-YANG	2244-N1TG1	N/A	2023-10-28

**Remark: The temporary antenna connector is soldered on the PCB board in order to perform conducted tests and this temporary antenna connector is listed in the equipment list.**

### 11.2 Measuring Instruments and Setting

The following table is the setting of spectrum analyzer.

Spectrum analyzer	Setting
Attenuation	Auto
Span Frequency	Set the span to 1.5 times the DTS bandwidth.
RB	3kHz
VB	10KHz
Detector	Peak
Trace	Max hold
Sweep Time	Automatic

### 11.3 Test Procedures

The testing follows the Measurement Procedure of FCC KDB No. 558074 D01 15.247 Meas Guidance v05r02.

- a. The transmitter output (antenna port) was connected to the spectrum analyzer.
- b. Set analyzer center frequency to DTS channel center frequency.
- c. Set the analyzer span to a minimum of 1.5 times the DTS bandwidth.
- d. Set the RBW  $\geq$  3 kHz. Set the VBW  $\geq$  3 x RBW.
- e. Detector = peak.
- f. Sweep time = auto couple.
- g. Trace mode = max hold.
- h. Allow trace to fully stabilize.
- i. Use the peak marker function to determine the maximum amplitude level.

### 11.4 Block Diagram of Test Setup

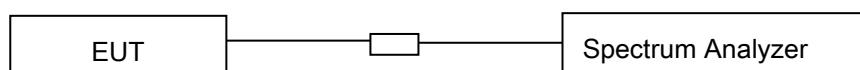

**11.5Limit**

The transmitted power density averaged over any 1 second interval shall not be greater +8dBm in any 3 kHz bandwidth.

**11.6Test Result**

Spectrum Detector: PK                      Test Date : 2022-11-17  
 Test By: Big                                  Temperature : 26°C  
 Test Result: PASS                          Humidity : 60%

Mode	Frequency (MHz)	Antenna	Conducted PSD (dBm/3kHz)	Duty Factor (dB)	Total PSD (dBm/3kHz)	Limit (dBm/3kHz)	Verdict
b	2412	Ant1	-13.82	0	-13.82	8	Pass
b	2437	Ant1	-14.33	0	-14.33	8	Pass
b	2462	Ant1	-13.04	0	-13.04	8	Pass
g	2412	Ant1	-16.57	0	-16.57	8	Pass
g	2437	Ant1	-17.6	0	-17.6	8	Pass
g	2462	Ant1	-16.77	0	-16.77	8	Pass
n20	2412	Ant1	-16.46	0	-16.46	8	Pass
n20	2437	Ant1	-17	0	-17	8	Pass
n20	2462	Ant1	-16.82	0	-16.82	8	Pass



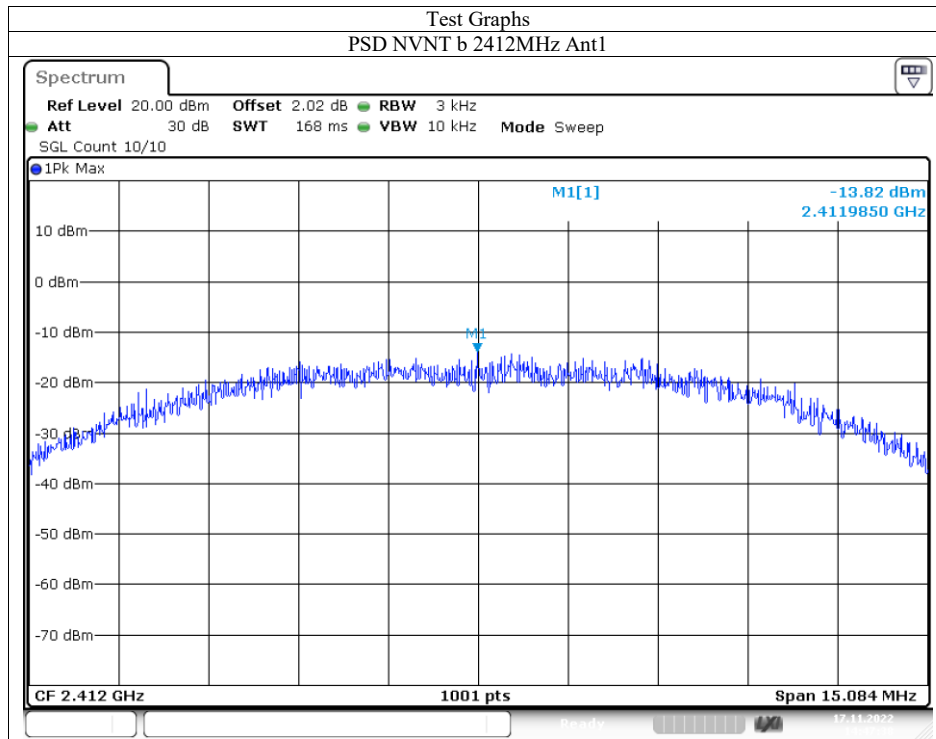

Date: 17.NOV.2022 14:47:38

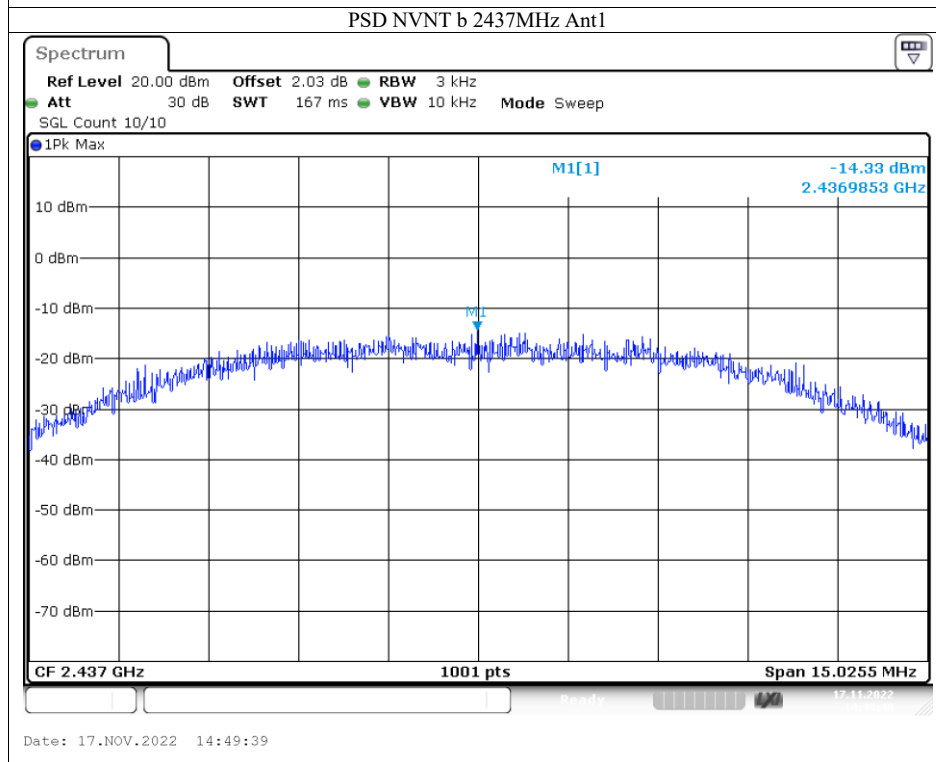

Date: 17.NOV.2022 14:49:39

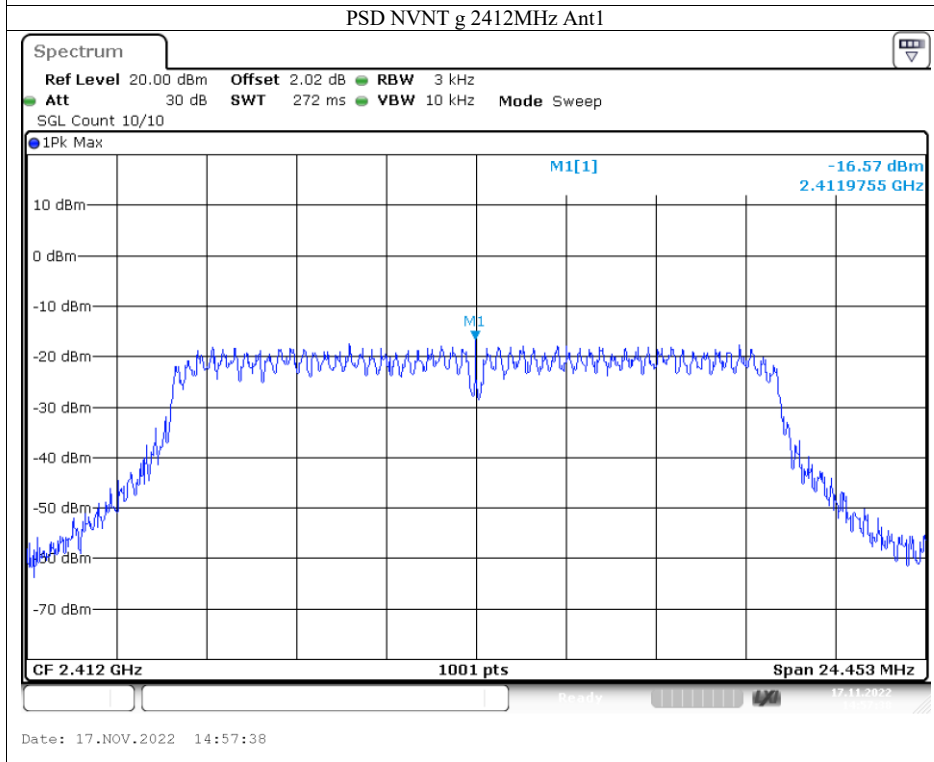
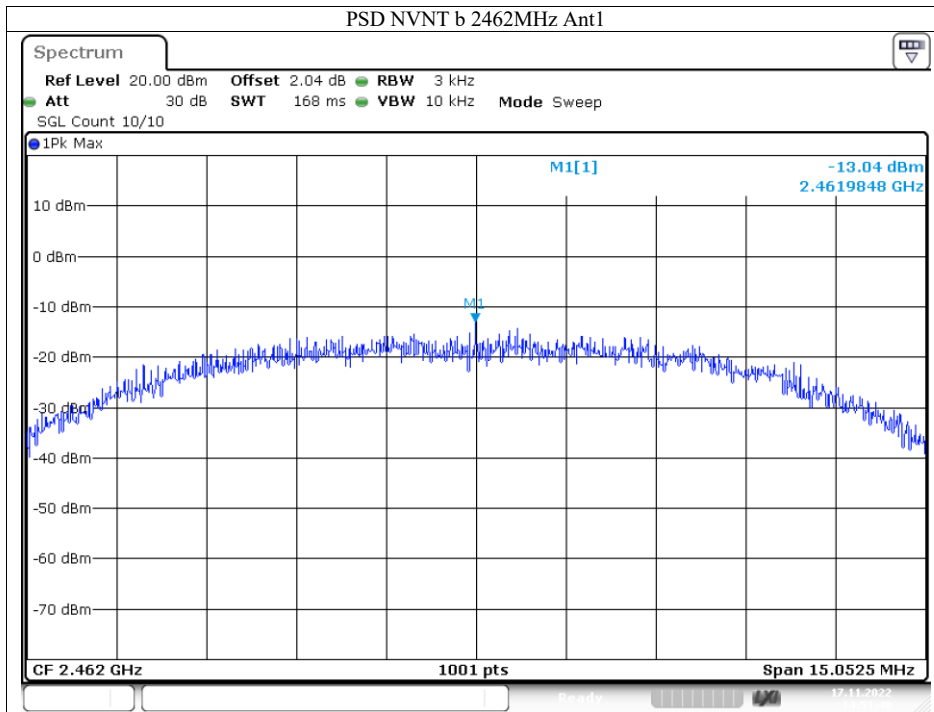

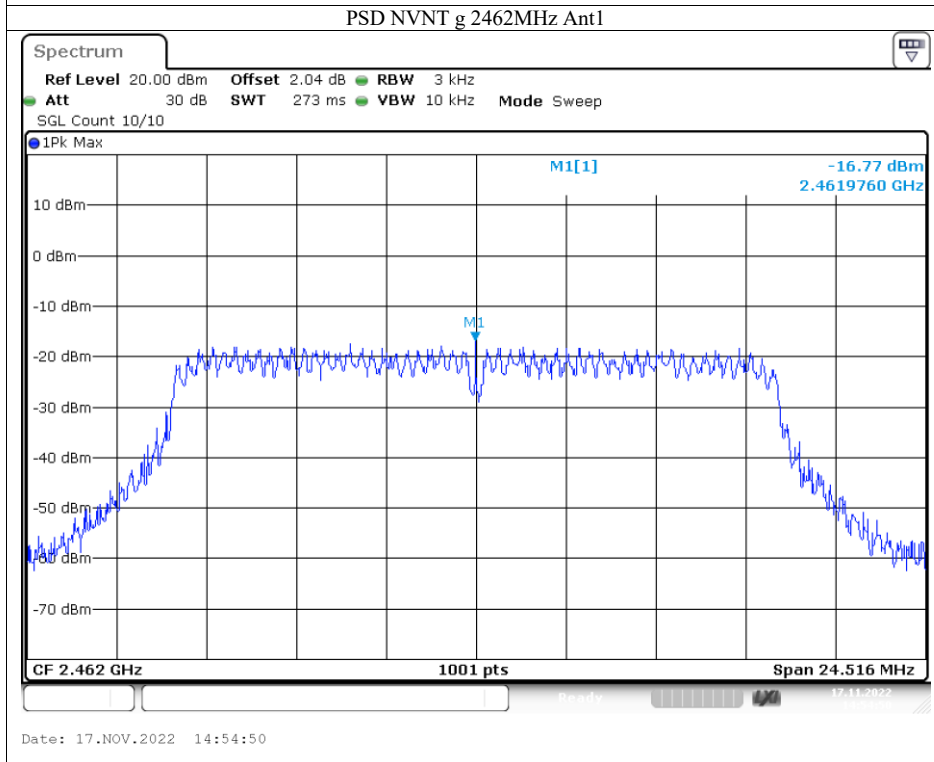
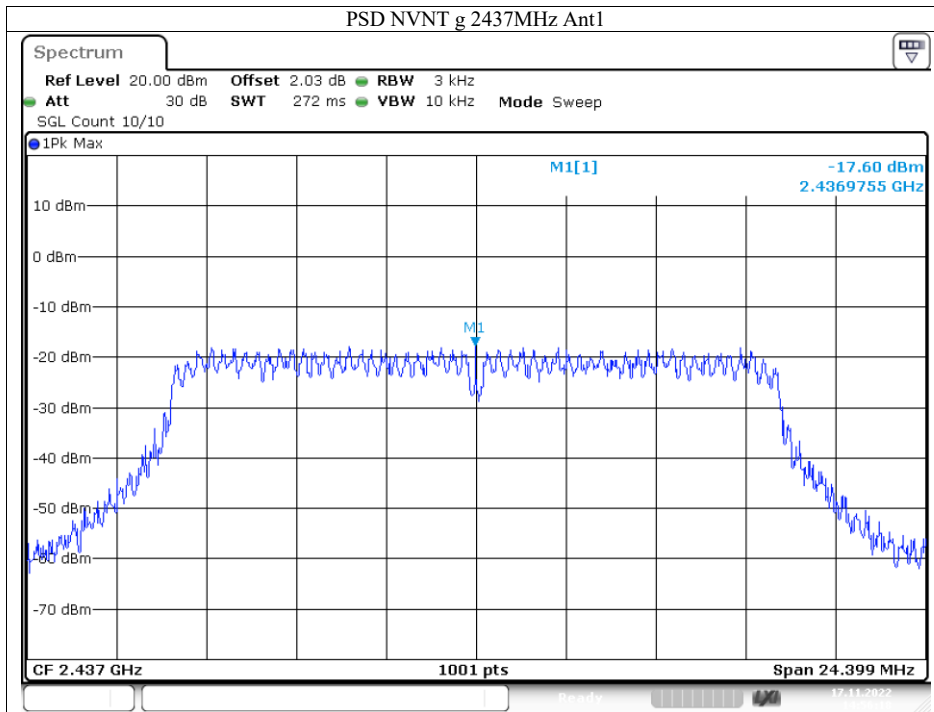

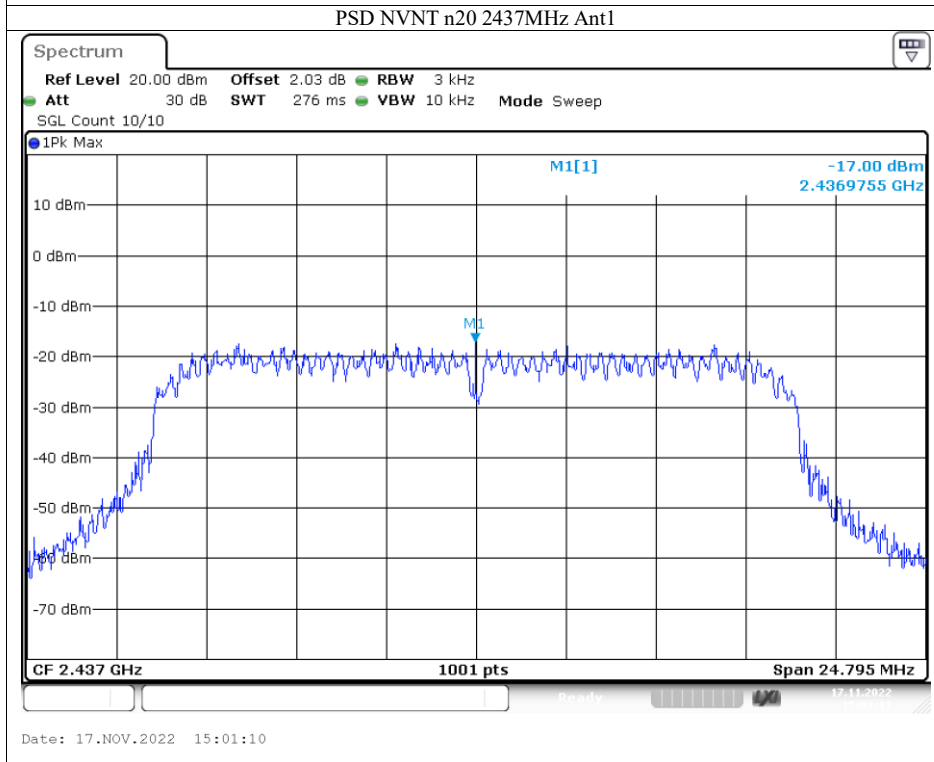
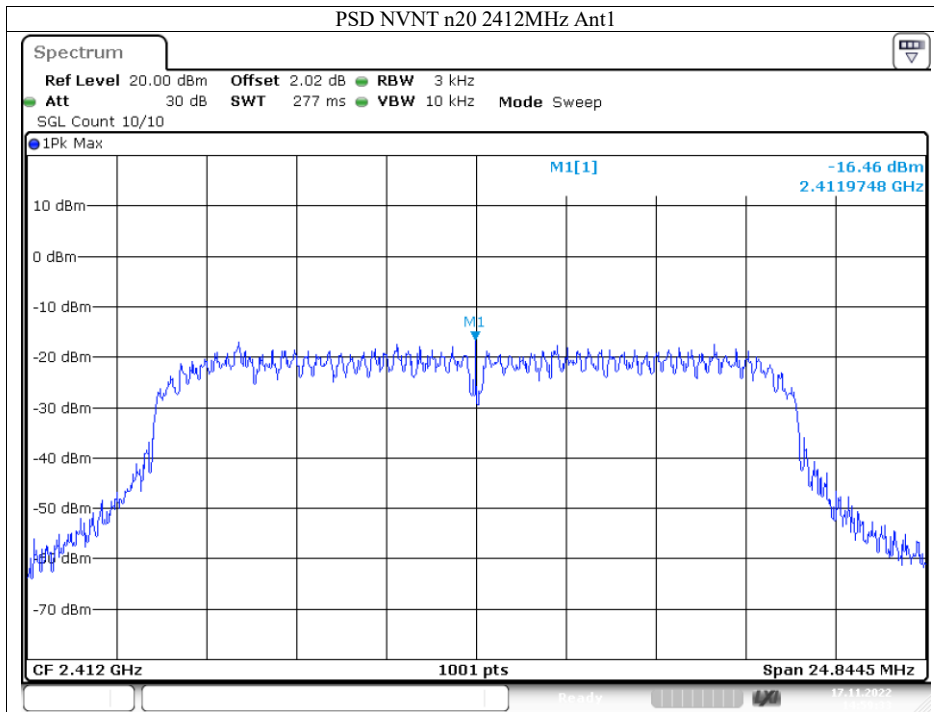



## 12. Antenna Port Emission

### 12.1 Test Equipment

EQUIPMENT TYPE	MFR	MODEL NUMBER	SERIAL NUMBER	CALIBRATED UNTIL
Spectrum Analyzer	Rohde & Schwarz	FSV40	US40240623	2023-10-28
Coaxial Cable	Gigalink Microwave	ZT40	19022092	2023-10-28
Antenna Connector	ARTHUR-YANG	2244-N1TG1	N/A	2023-10-28

**Remark: The temporary antenna connector is soldered on the PCB board in order to perform conducted tests and this temporary antenna connector is listed in the equipment list.**

### 12.2 Measuring Instruments and Setting

The following table is the setting of spectrum analyzer.

Spectrum analyzer	Setting
Attenuation	Auto
RB	100kHz
VB	300kHz
Detector	Peak
Trace	Max hold

### 12.3 Test Procedures

The testing follows the Measurement Procedure of FCC KDB No. 558074 D01 15.247 Meas Guidance v05r02 .

The conducted spurious emissions were measured conducted using a spectrum analyzer at low, Middle, and high channels, the limit was determined by attenuation 20dB of the RF peak power output.

### 12.4 Block Diagram of Test setup

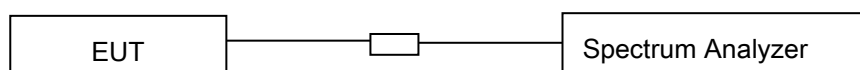

### 12.5 Test Result

**PASS.**

Please refer to following pages.

Spectrum Detector: PK  
Test By: Big  
Test Result: PASS

Test Date : 2022-11-17  
Temperature : 26°C  
Humidity : 60%

Mode	Frequency (MHz)	Antenna	Max Value (dBc)	Limit (dBc)	Verdict
b	2412	Ant1	-52.35	-20	Pass
b	2437	Ant1	-52.26	-20	Pass
b	2462	Ant1	-51.16	-20	Pass
g	2412	Ant1	-47.94	-20	Pass
g	2437	Ant1	-48.63	-20	Pass
g	2462	Ant1	-47.53	-20	Pass
n20	2412	Ant1	-47.7	-20	Pass
n20	2437	Ant1	-47.38	-20	Pass
n20	2462	Ant1	-47.5	-20	Pass

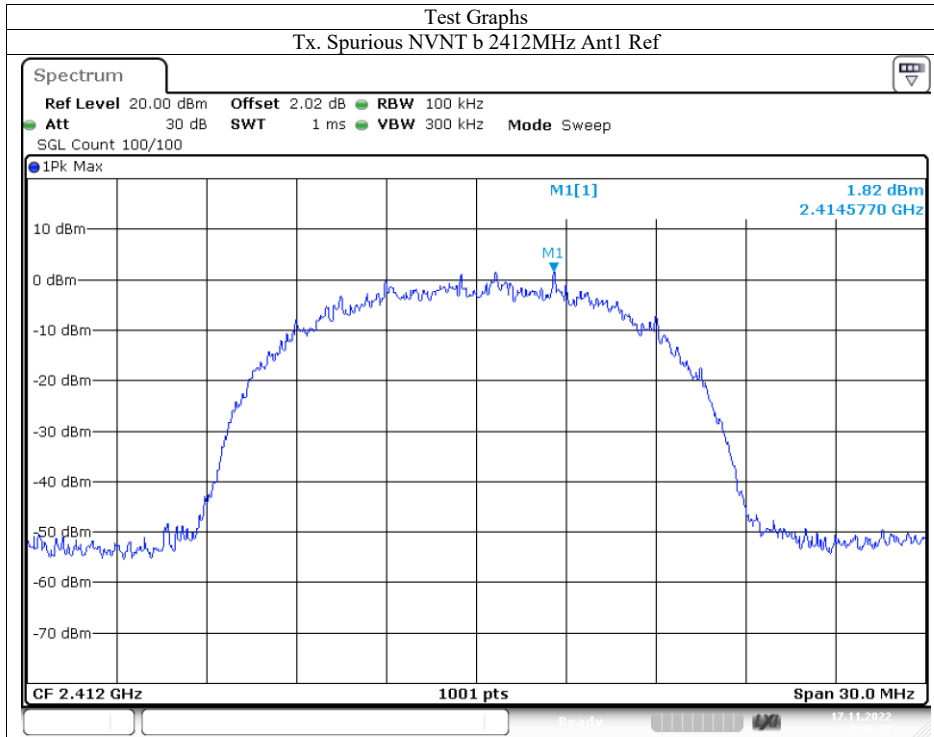

Date: 17.NOV.2022 14:48:02

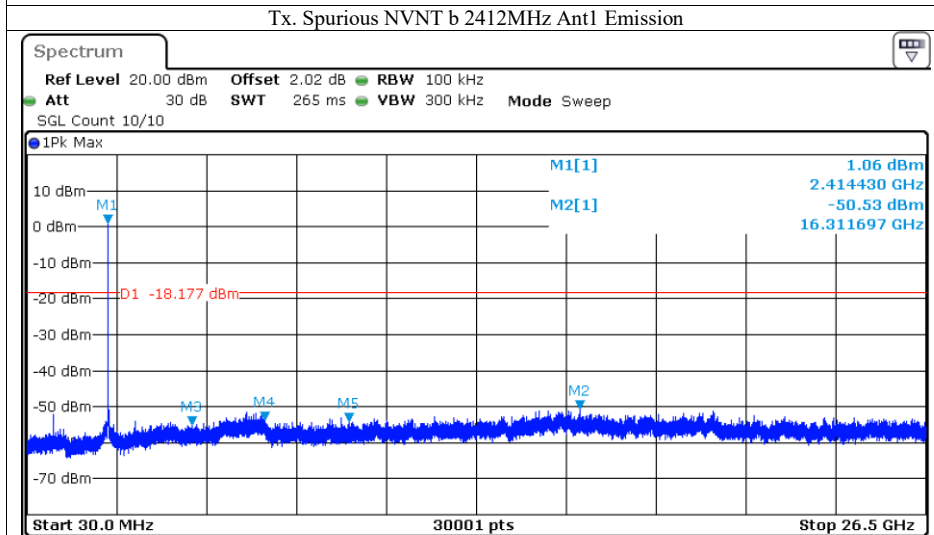

**Marker**

Type	Ref	Trc	X-value	Y-value	Function	Function Result
M1	1		2.41443 GHz	1.06 dBm		
M2	1		16.311697 GHz	-50.53 dBm		
M3	1		4.896068 GHz	-55.07 dBm		
M4	1		7.036609 GHz	-53.76 dBm		
M5	1		9.526554 GHz	-54.18 dBm		

Date: 17.NOV.2022 14:48:15



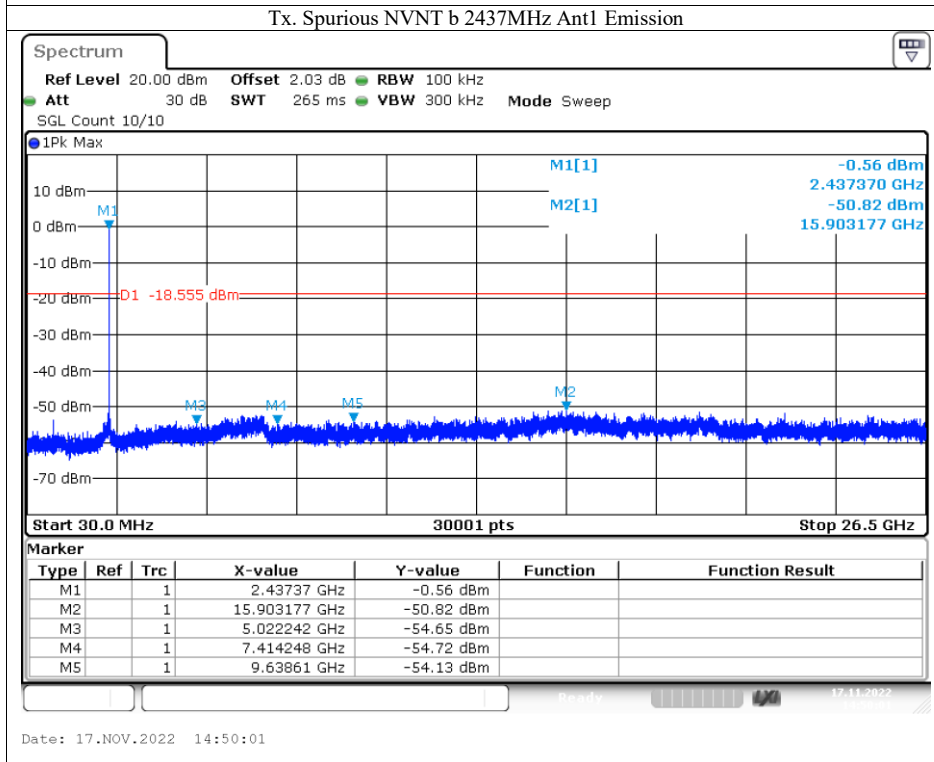
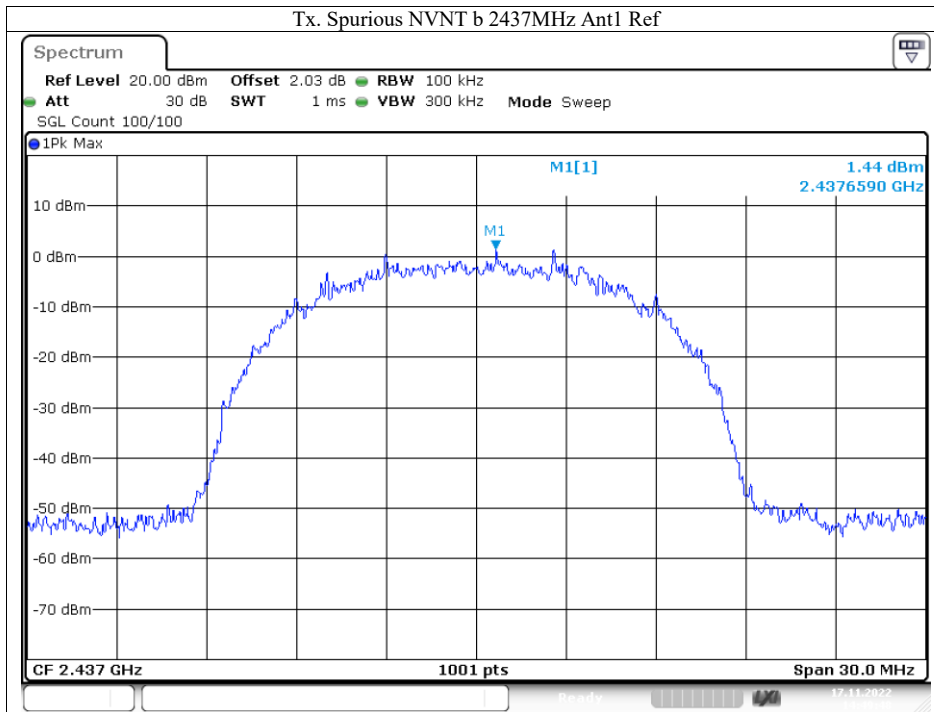

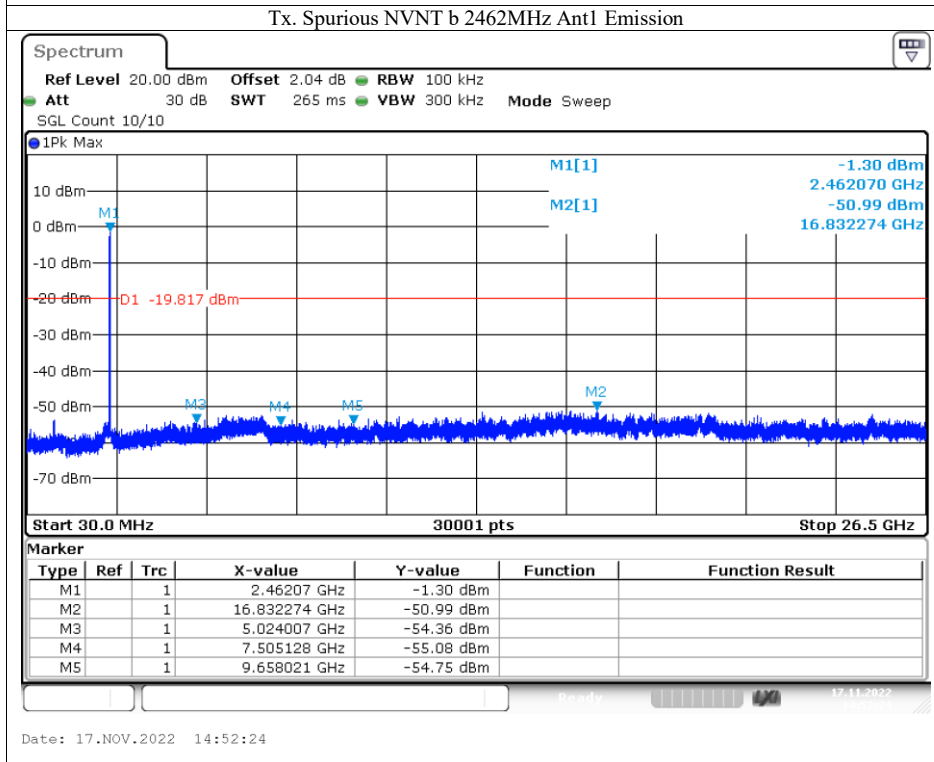
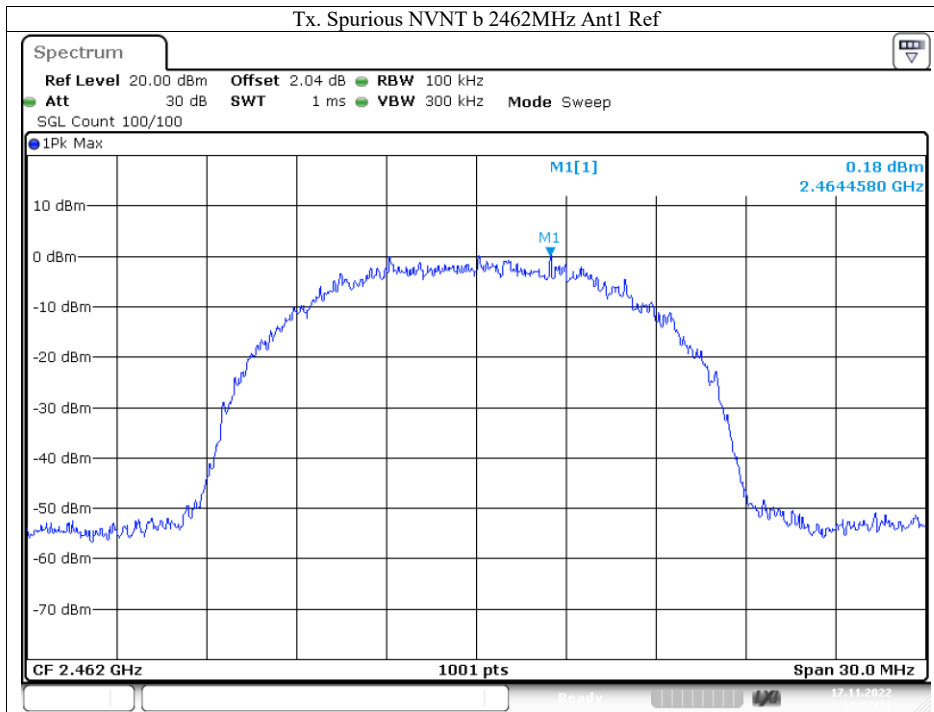

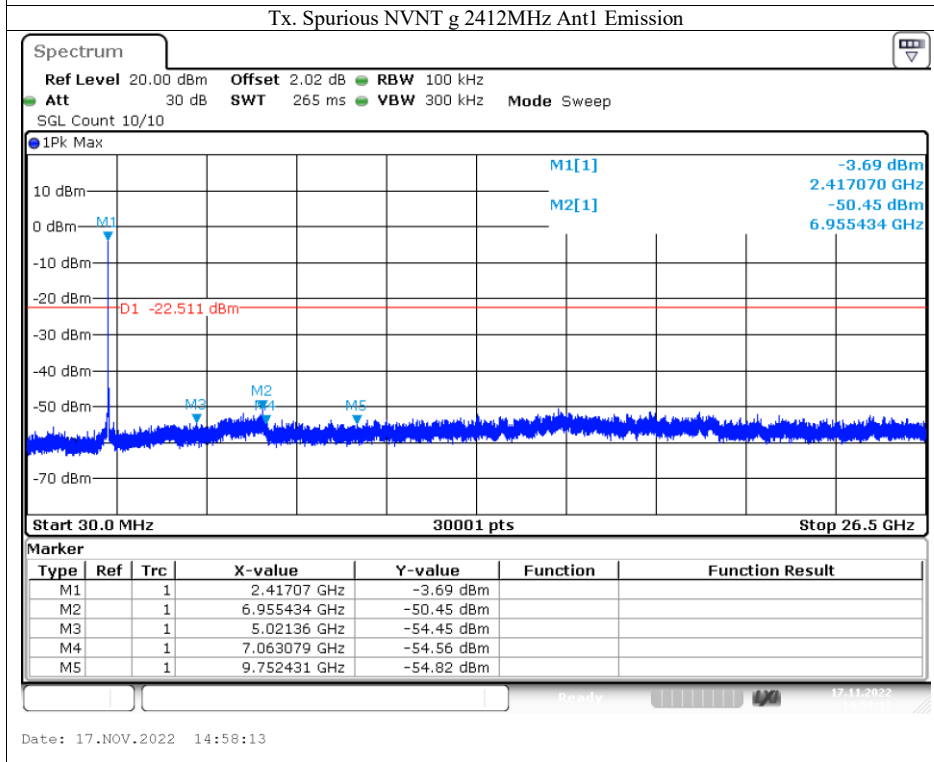
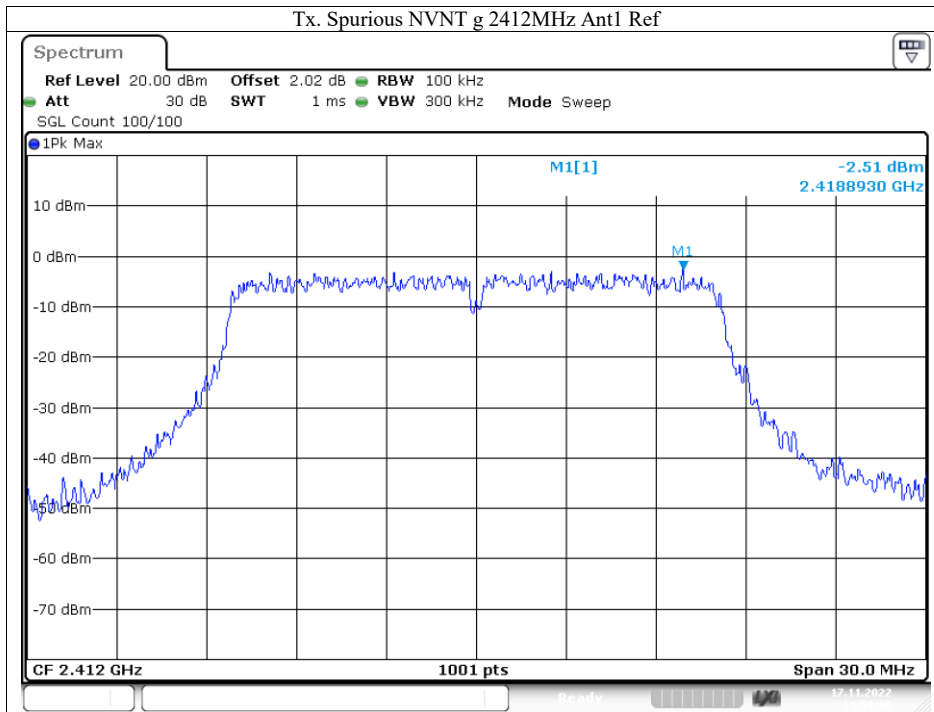

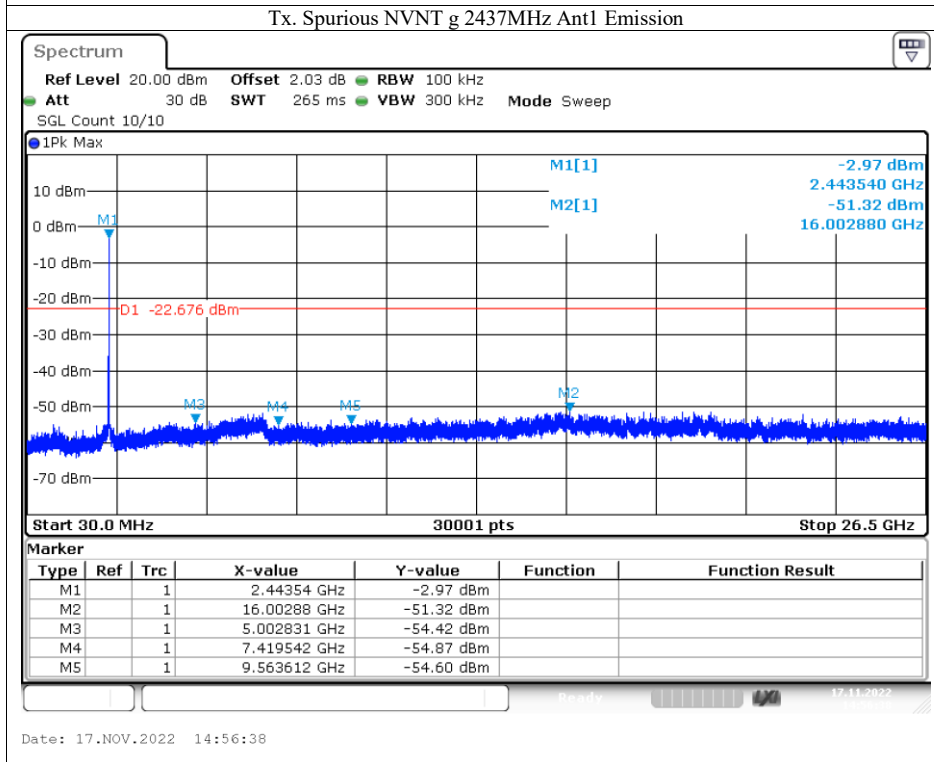
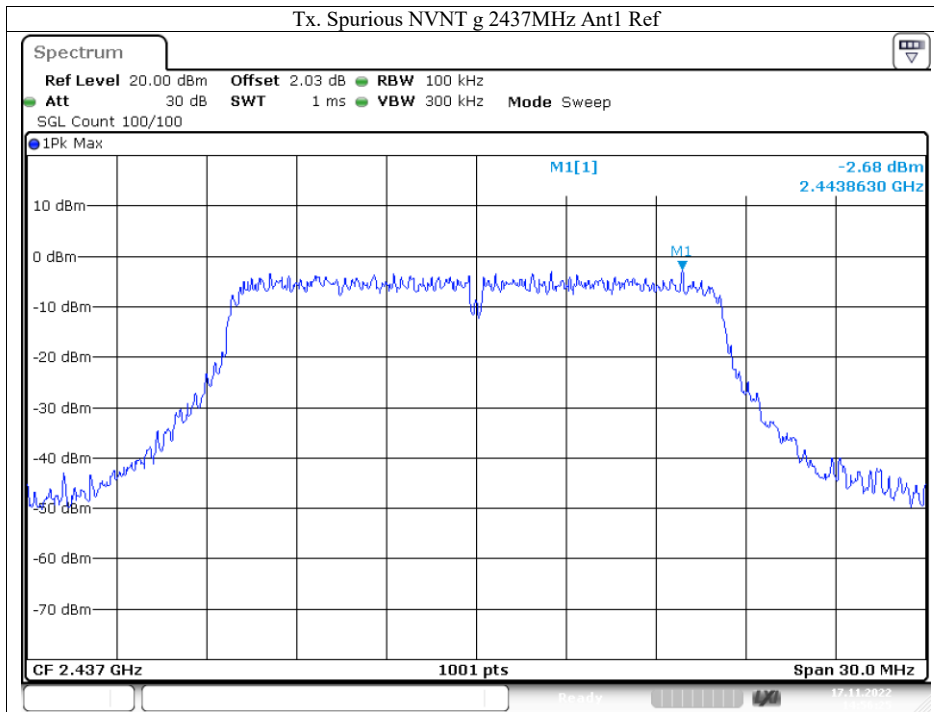

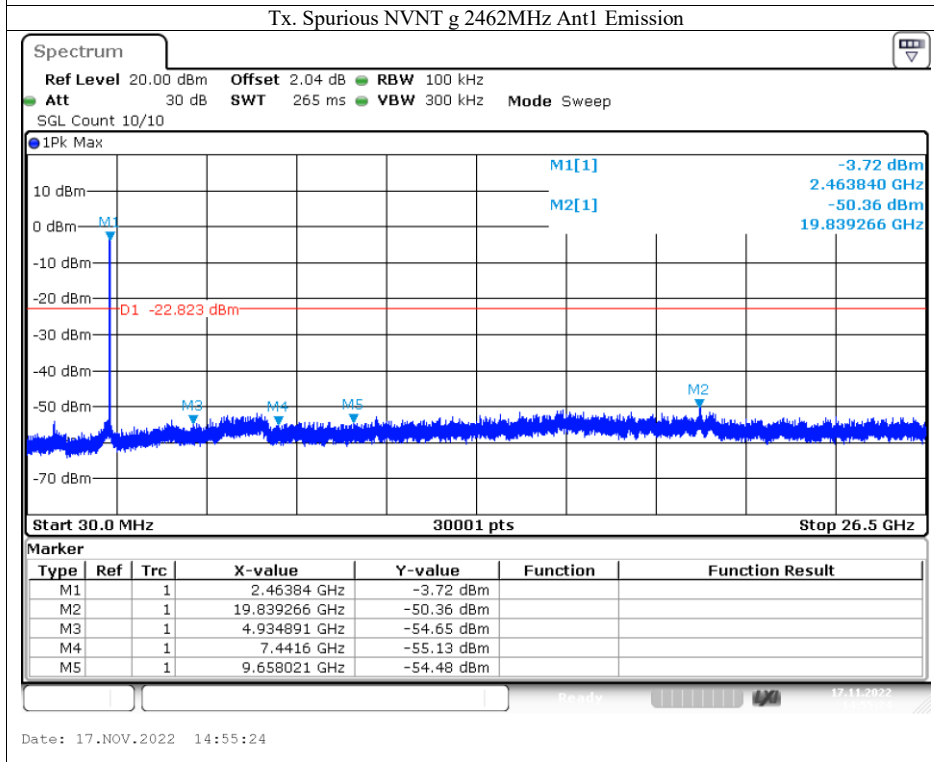
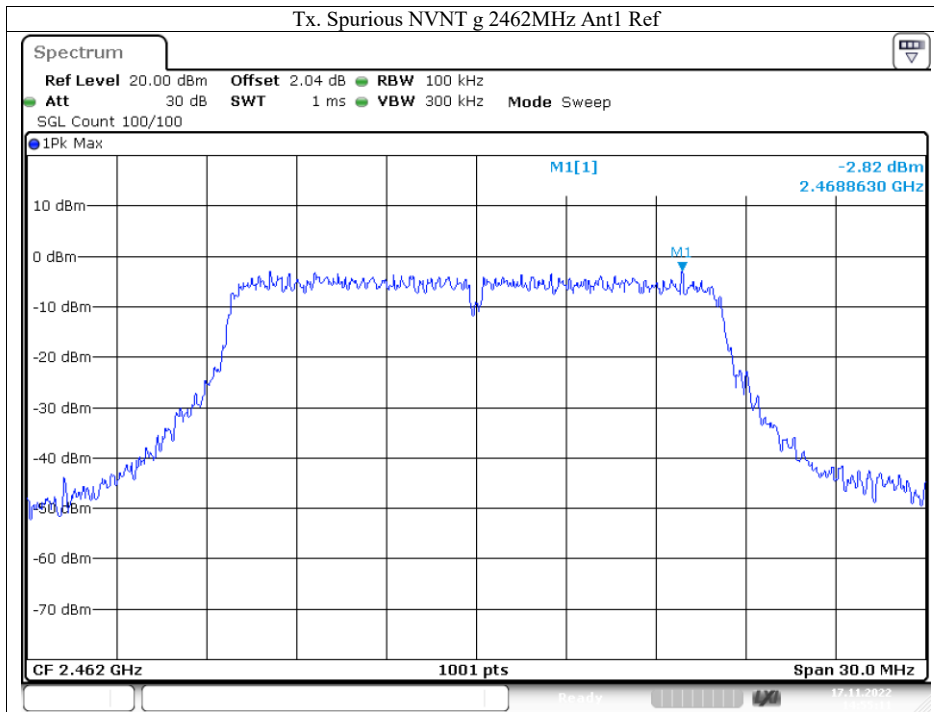

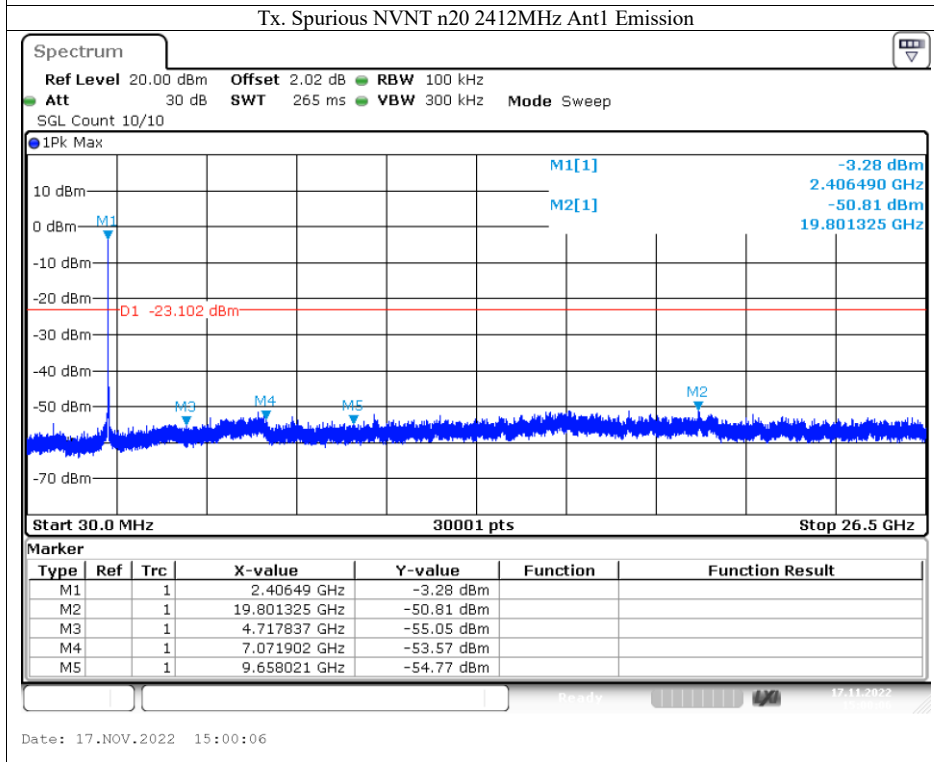
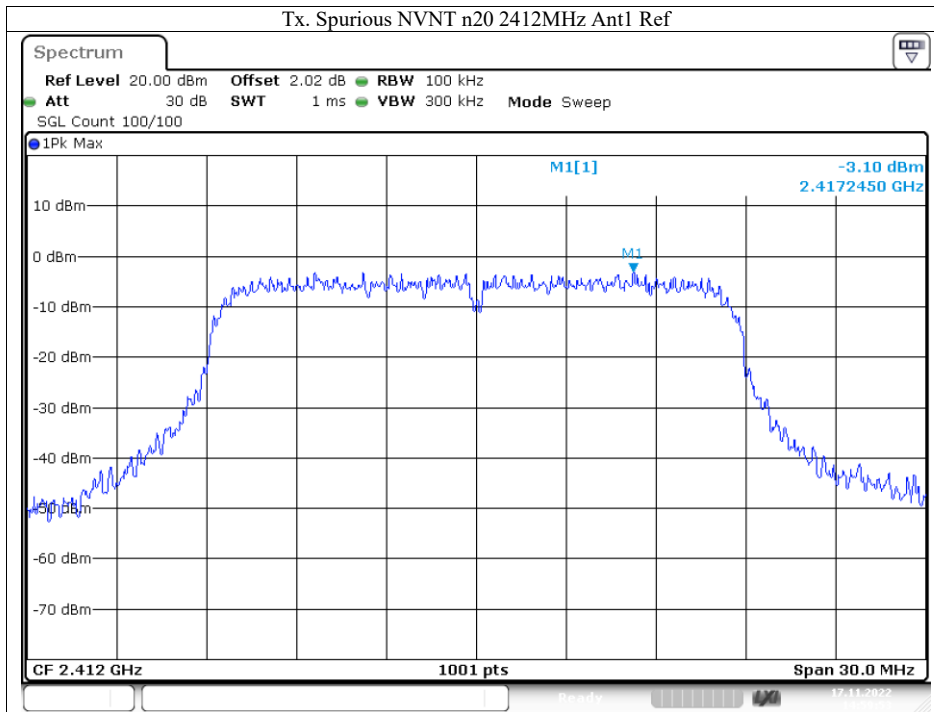

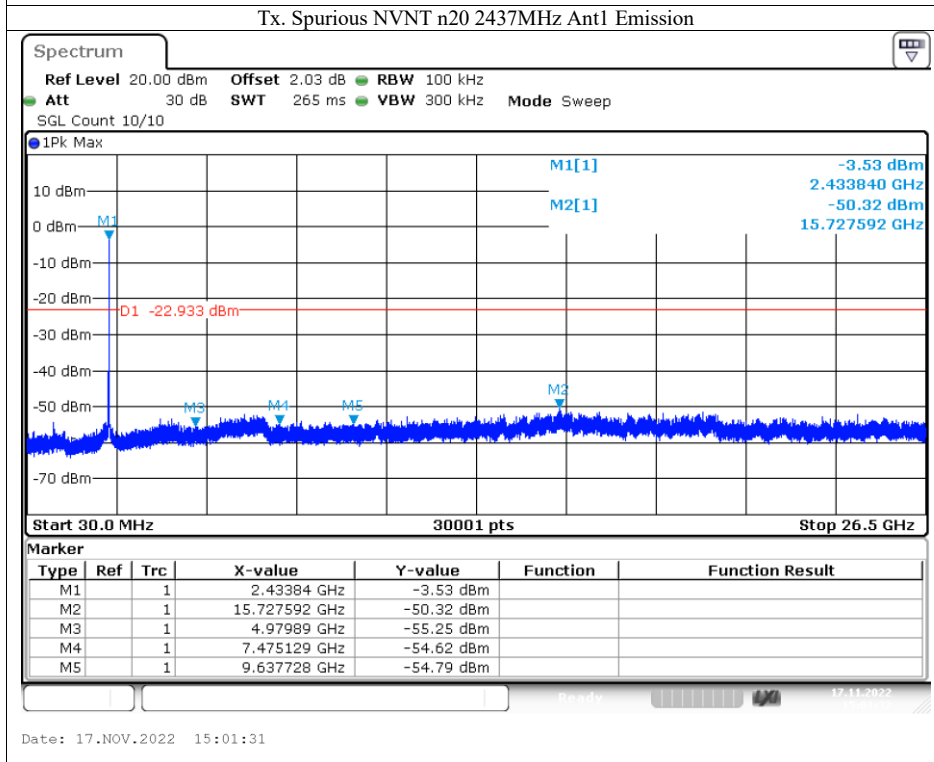
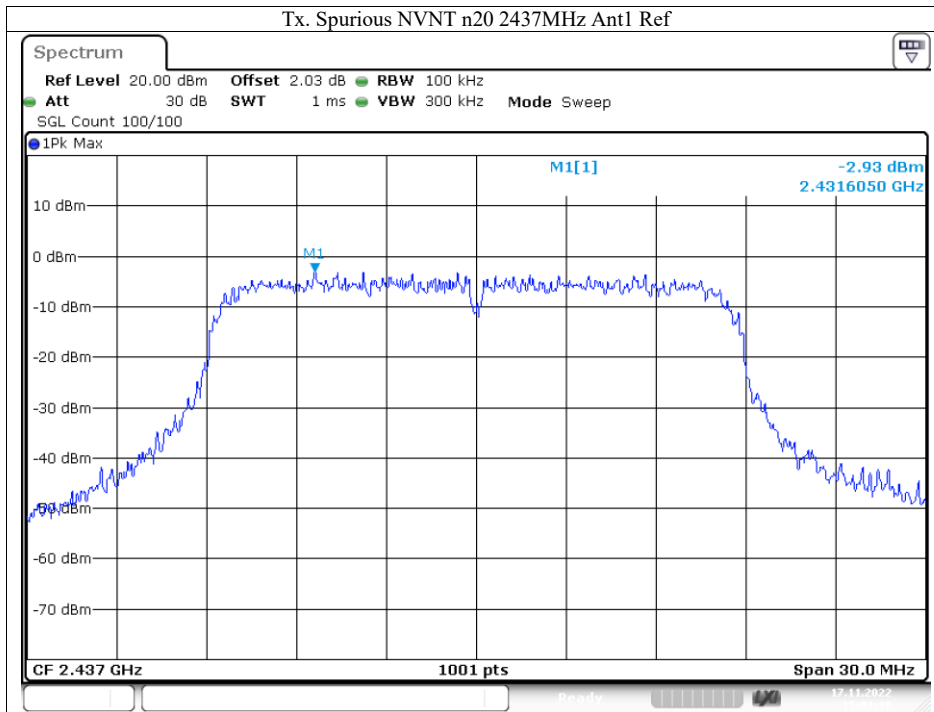

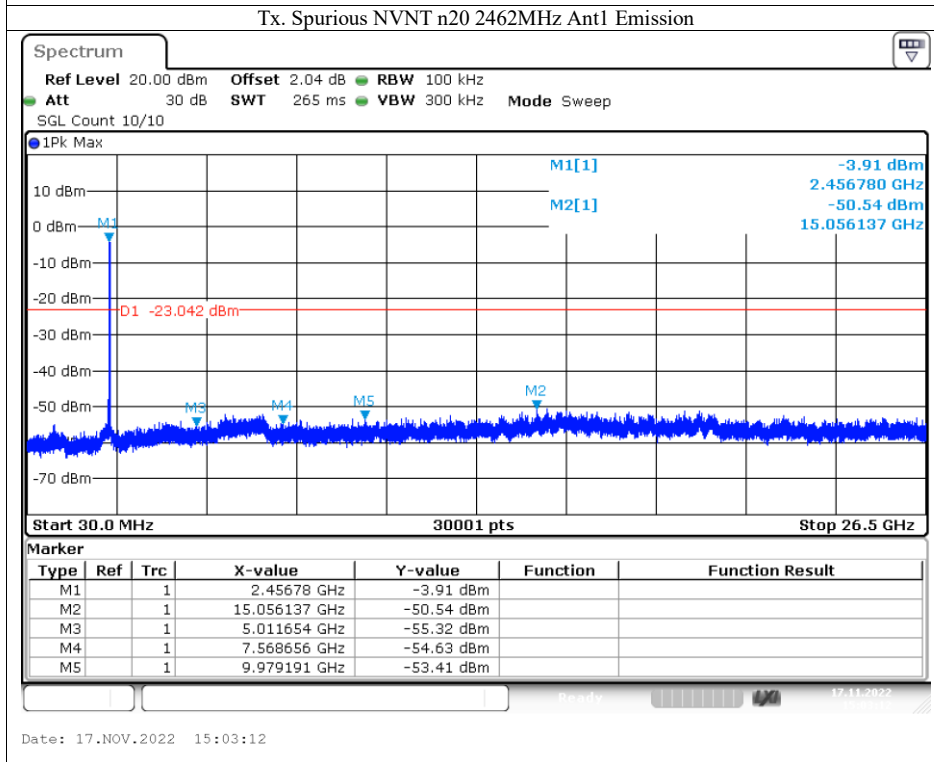
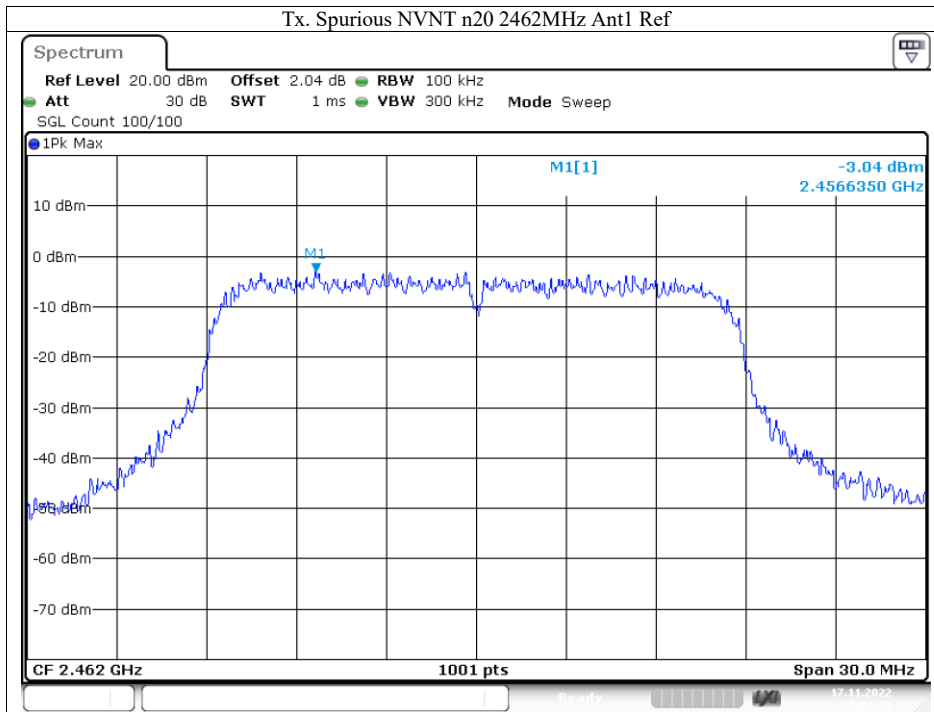



## **13. Antenna Application**

### **13.1 Antenna Requirement**

For intentional device, according to FCC 47 CFR Section 15.203, an intentional radiator shall be designed to ensure that no antenna other than that furnished by the responsible party shall be used with the device. And according to FCC 47 CFR Section 15.247 (b), if transmitting antennas of directional gain greater than 6dBi are used, the power shall be reduced by the amount in dB that the directional gain of the antenna exceeds 6dBi.

### **13.2 Result**

The EUT'S antenna is an internal PCB antenna. The antenna's gain is -2.49dBi and meets the requirement.

## **14. Photos of EUT**

Please refer to the report: E01A22100615F00701

---The end of report---