

Quick Start Guide

Apply to: Reolink Go Ranger PT

Content

What's in the Box	2
Camera Introduction	3
Set up the Camera	4
Charge the Camera	10
Install the Camera	11
Safety Instructions of Battery Usage	15
Troubleshooting	16
Specifications	17
Notification of Compliance	17

What's in the Box



Camera

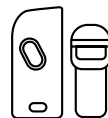

Camera Bracket

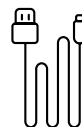

USB-C Cable



Antenna



Reset Needle



Quick Start Guide

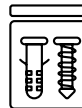

Pack of Screws



Mounting Hole Template

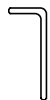

Hex Key

Camera Introduction

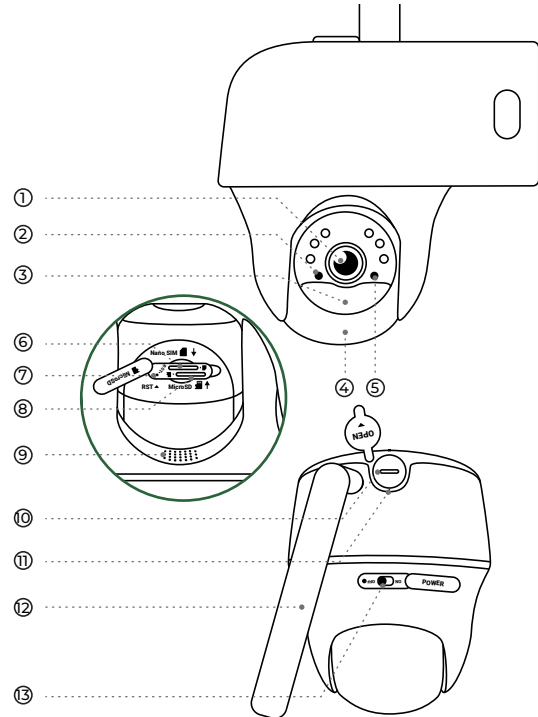

- ① Lens
- ② Daylight Sensor
- ③ Built-in PIR Sensor
- ④ Built-in Mic
- ⑤ Status LED
- ⑥ Nano SIM Card Slot
* Rotate the camera's lens to find the reset hole, SIM card slot and SD card slot.
- ⑦ Reset Hole
* Press the reset button with a pin to restore camera to factory settings.
- ⑧ microSD Card Slot
- ⑨ Speaker
- ⑩ USB-C Cable
- ⑪ Battery Status LED
- ⑫ Antenna
- ⑬ Power Switch
* Please always cover the USB charging port with rubber plug after charging the battery.

Set up the Camera

Activate SIM Card for the Camera

- Choose a Nano SIM card that supports WCDMA and FDD LTE.
- Some SIM cards have a PIN code. You may use your smartphone to disable the PIN first.

NOTE: Do not insert the IoT or M2M SIM into your smartphone.

Insert the SIM Card

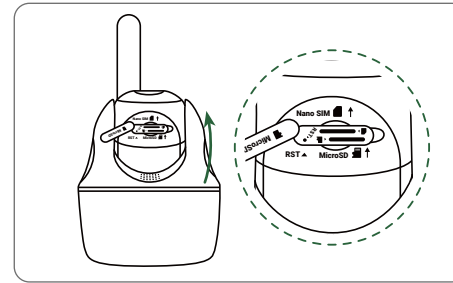

Rotate the camera lens, and remove the rubber cover.

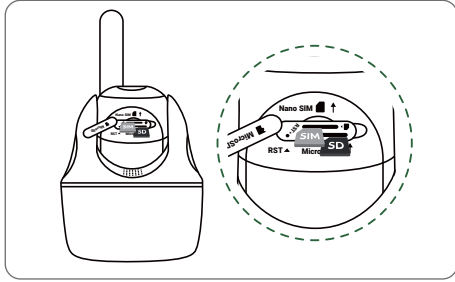

Insert the SIM card.

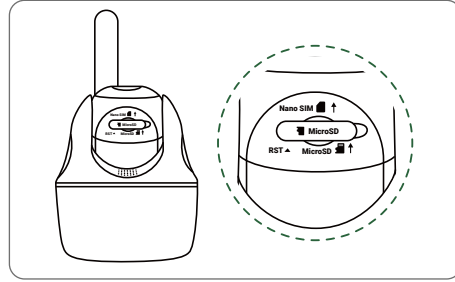

With these done, press the rubber cover firmly for better waterproof performance.

* The SIM card slot is above the SD card slot. When inserting the SIM card in, remember that the gold contacts shall face down and you need to push the trimmed corner inside the camera.

* The SD card slot is below the SIM card slot. When inserting the SD card in, remember that gold contacts shall face up.

Register the SIM Card

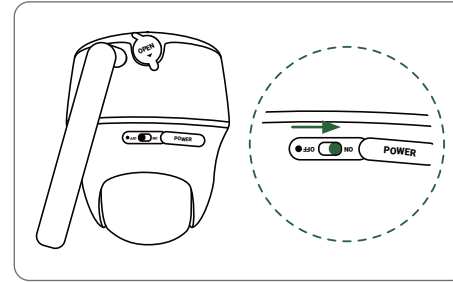

With the SIM card inserted, you can turn on the camera.

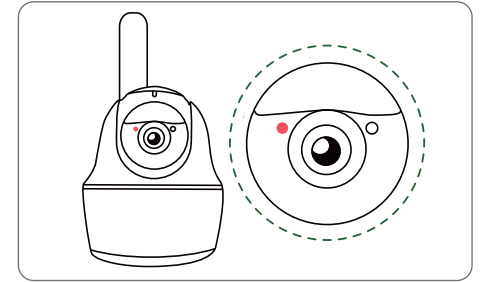
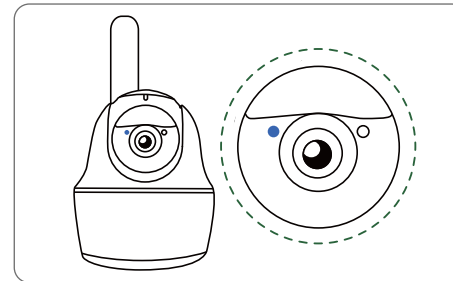

Wait a few seconds and a red light will be on and solid for a couple of seconds. Then, it will go out.

A blue LED will flash for a few seconds and then go solid before going out. You will hear a voice prompt "Network connection succeeded", which means the camera has been successfully connected to the network.

Set up the Camera on the Phone

Step 1

Scan to download the Reolink App from the App Store or Google Play store.



Step 2

Turn on the power switch to power on the camera.

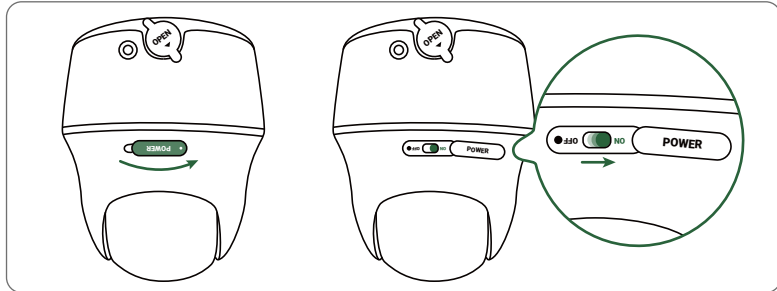

Step 3

Launch the Reolink App, click the “+” button in the top right corner to add the camera. Scan the QR code on the device and follow the onscreen instructions to finish initial setup.

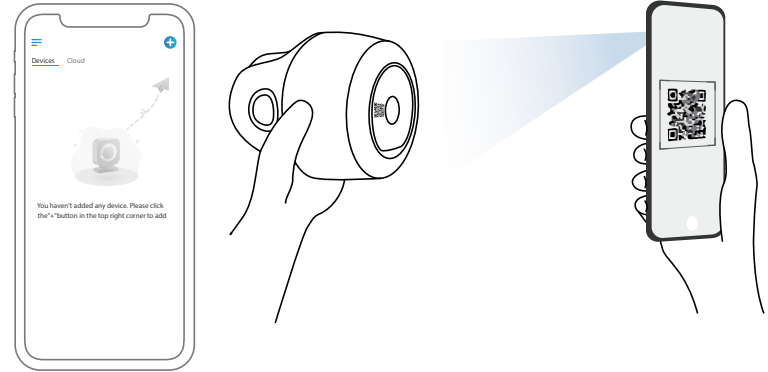

Set up the Camera on PC (Optional)

Step 1

Download and install the Reolink Client: Go to <https://reolink.com> > Support > App&Client.

Step 2

Launch the Reolink Client, click the “+” button, input the UID code of the camera to add it and follow the onscreen instructions to finish initial setup.

NOTE: You may also run into the following situations:

	Voice Prompt	Camera Status	Solutions
1	"SIM card cannot be recognized"	Camera cannot recognize this SIM card.	<ol style="list-style-type: none"> 1. Check if the SIM card is facing the reverse direction. 2. Check if the SIM card is not fully inserted and insert it again
2	"The SIM card is locked with a PIN. Please disable it"	Your SIM card has a PIN.	Put the SIM card into your mobile phone and disable the PIN.
3	"Not registered on network. Please activate your SIM card and check the signal strength"	Camera fails to register to the operator network.	<ol style="list-style-type: none"> 1. Check whether your card is activated or not. If not, please call your operator to activate the SIM card. 2. The signal is weak at the current position. Please move the camera to a location with better signal. 3. Check if you are using the correct version of the camera.
4	"Network connection failed"	Camera fails to connect to the server.	The camera will be in Standby mode and reconnect later.
5	"Data call failed. Please confirm your cellular data plan is available or import the APN settings"	The SIM card has run out of data or APN settings are not correct.	<ol style="list-style-type: none"> 1. Please check whether the data plan for the SIM card is still available. 2. Import the correct APN settings to the camera.

Charge the Camera

It's recommended to fully charge the camera before installing it.

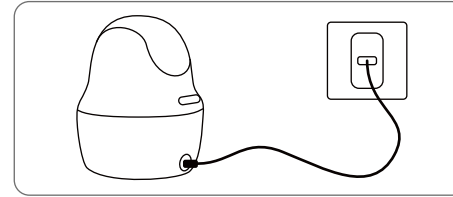

Charge the camera with a 5V power adapter (not included).

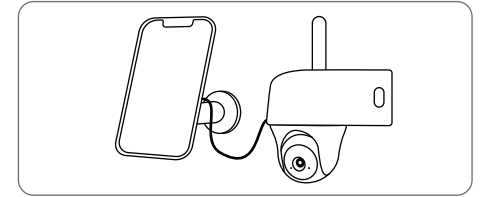

Charge the camera with the Reolink Solar Panel

Charging Indicator:

- Orange LED: Charging
- Green LED: Fully charged

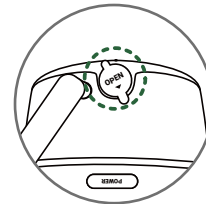

For better weatherproof performance, please always cover the charging port with the rubber plug after charging the camera.

Install the Camera

• For better motion detection performance, it is recommended to position the camera perpendicular to the expected movement of wildlife.

• It is recommended to install the camera about 2 meters (7ft) above the ground to maximize the detection range of the PIR motion sensor.

NOTE: Mount the camera where there are few trees to ensure better monitoring.

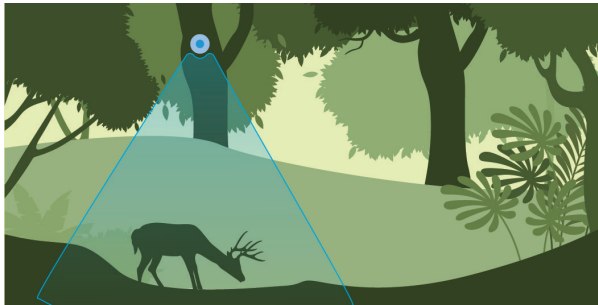
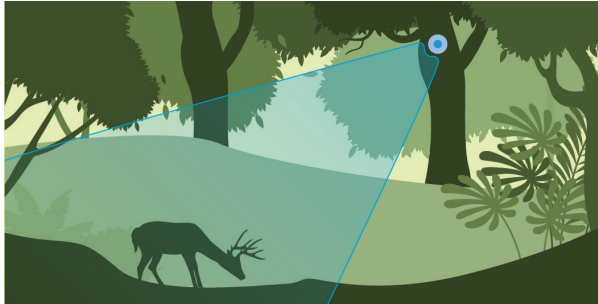

Install the Camera on a Surface

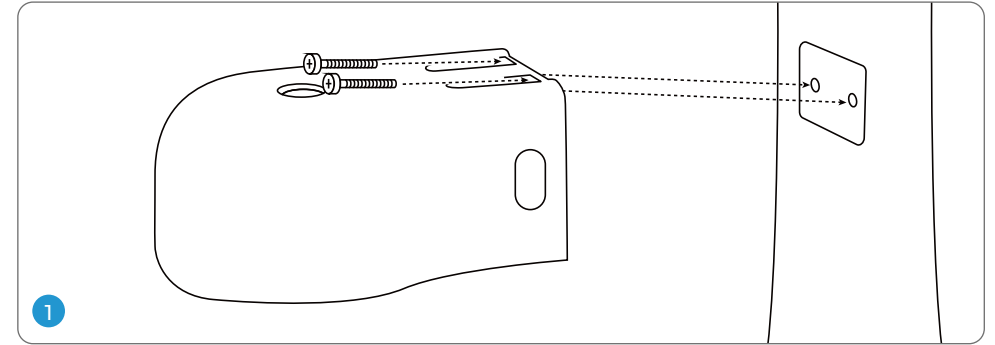

Install the Camera on a Wall

If installing on a wood surface, hold the security mount in place and screw it directly into your wall.

If installing on a masonry surface like stucco or brick, drill holes in a slightly angled way in accordance with the mounting hole template, then insert wall anchors before screwing the security mount into your wall.

NOTE: Avoid using drills which could damage the bracket.

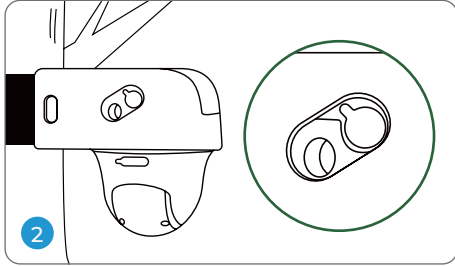

Put the camera into the bracket, make sure that the hole on the bracket aligns with the antenna post and the charging port, as shown in the picture.

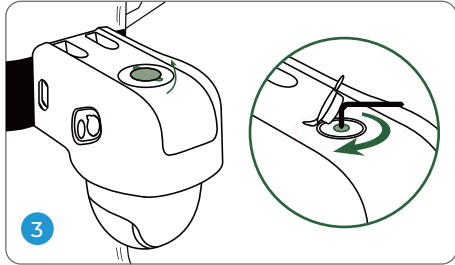

Open the rubber plug on the top of the bracket and secure the camera with the hex key, then close it firmly.

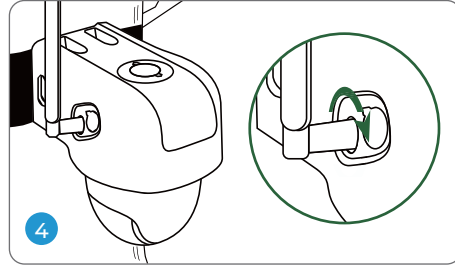

Install the antenna to the camera.

Install the Camera with Loop Strap

Thread the provided strap through the bracket and fasten it to a tree.

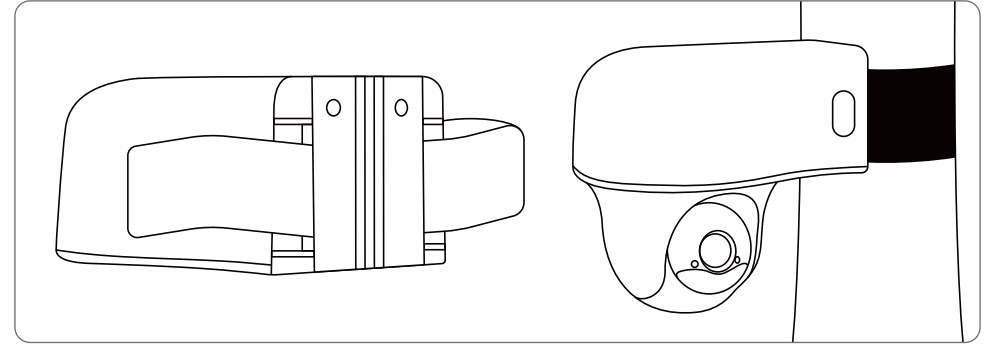

Safety Instructions of Battery Usage

The camera is not designed for running 24/7 at full capacity or around-the-clock live streaming. It's designed to record motion events and to live view remotely only when you need it. Learn useful tips on how to extend the battery life in this post <https://support.reolink.com/hc/en-us/articles/360006991893>

1. The battery is built-in, so do not remove it from the camera.
2. Charge the rechargeable battery with a standard and high-quality DC 5V battery charger or Reolink solar panel. Do not charge the battery with solar panels from any other brands.
3. Charge the battery when temperatures are between 0°C and 45°C and always use the -10°C to 55°C (14°F to 131°F).
4. Keep the USB charging port dry, clean and free of any debris and cover the USB charging port with the rubber plug when the battery is fully charged.
5. Do not charge, use or store the battery near any ignition sources, such as fire or heaters.
6. Do not use the battery if it gives off an odor, generates heat, becomes discolored or deformed, or appears abnormal in any ways. If the battery is being used or charged, turn off the power switch or remove the charger immediately, and stop using it.
7. Always follow the local waste and recycle laws when you get rid of the used battery.

Troubleshooting

Camera is not Powering On

If your camera is not turning on, please apply the following solutions:

- Make sure you've turned the power button on.
- Charge the battery with a DC 5V/2A power adapter. When the green light is on, the battery is fully charged.

If these won't work, please contact Reolink Support.

PIR Sensor Fails to Trigger Alarm

If the PIR sensor fails to trigger any kind of alarm within the covered area, try the following solutions:

- Make sure that the PIR sensor or the camera is installed in the right direction.
- Make sure the PIR sensor is enabled or the schedule is set up properly and running.
- Check the sensitivity settings and make

sure it's set up properly.

- Make sure the battery is working.
- Reset the camera and try again.

If these won't work, please contact Reolink Support.

Unable to Receive Push Notifications

If you fail to receive any push notifications when motion is detected, try the following solutions:

- Make sure the push notification has been enabled.
- Make sure the PIR schedule is set up properly.
- Check the network connection on your phone and try again.
- Make sure the camera is connected to the Internet. If the LED indicator under the camera lens is solid red or flickering red, it means that your device disconnects from the Internet.
- Make sure you've enabled Allow Notifications on your phone. Go to the System Settings on your phone and allow Reolink App to send push notifications.

If these won't work, please contact Reolink Support.

Specifications

PIR Detection & Alerts

PIR Detection Distance:
Adjustable/up to 10m (33ft)
PIR Detecting Angle: 120° horizontal
Audio Alert:
Customized voice-recordable alerts
Other Alerts:
Instant email alerts and push notifications

General

Operating Temperature:
0°C to 35°C
Weather Resistance:
IP64 certified weatherproof
Size: 98 x 112 mm
Weight (Battery included): 485g (17.1 oz)

Notification of Compliance

FCC Compliance Statement

This device complies with Part 15 of the FCC Rules. Operation is subject to the following two conditions: (1) this device may not cause harmful interference, and (2) this device must accept any interference received, including interference that may cause undesired operation. Changes or modifications not expressly approved by the party responsible for compliance could void the user's authority to operate the equipment.

NOTE: This equipment has been tested and found to comply with the limits for a Class B digital device, pursuant to Part 15 of the FCC Rules. These limits are designed to provide reasonable protection against harmful interference in a residential installation. This equipment generates, uses and can radiate radio frequency energy and, if not installed and used in accordance with the instructions, may cause harmful interference to radio communications. However, there is no guarantee that interference will not occur in a particular installation. If this equipment does cause harmful interference to radio

or television reception, which can be determined by turning the equipment off and on, the user is encouraged to try to correct the interference by one or more of the following measures:

- Reorient or relocate the receiving antenna.
- Increase the separation between the equipment and receiver.
- Connect the equipment into an outlet on a circuit different from that to which the receiver is connected.
- Consult the dealer or an experienced radio/TV technician for help.

FCC RF Exposure Warning Statements:

This equipment complies with FCC radiation exposure limits set forth for an uncontrolled environment. This equipment shall be installed and operated with minimum distance 20cm between the radiator & body.

Reolink declares that this device is in compliance with the essential requirements and other relevant provisions of Directive 2014/53/EU.



Correct Disposal of This Product

This marking indicates that this product should not be disposed with other household wastes throughout the EU. To prevent possible harm to the environment or human health from uncontrolled waste disposal, recycle it responsibly to promote the sustainable reuse of material resources. To return your used device, please use the return and collection systems or contact the retailer where the product was purchased. They can take this product for environment safe recycling.

Limited Warranty

This product comes with a 2-year limited warranty that is valid only if purchased from Reolink Official Store or a Reolink authorized reseller. Learn more: <https://reolink.com/warranty-and-return/>.

NOTE: We hope that you enjoy the new purchase. But if you are not satisfied with the product and plan to return, we strongly suggest that you reset the

camera to factory default settings and take out the inserted SD card before returning.

Terms and Privacy

Use of the product is subject to your agreement to the Terms of Service and Privacy Policy at reolink.com. Keep out of reach of children.

End User License Agreement

By using the Product Software that is embedded on the Reolink product, you agree to the terms of this End User License Agreement ("EULA") between you and Reolink. Learn more: <https://reolink.com/eula/>.

ISED Radiation Exposure Statement

This device contains licence-exempt transmitter(s)/receiver(s) that comply with Innovation, Science and Economic Development Canada's licence-exempt RSS(s). Operation is subject to the following two conditions:

- (1) This device may not cause interference.
- (2) This device must accept any interference, including interference that may cause undesired operation of the device.

L'émetteur/récepteur exempt de licence contenu dans le présent appareil est conforme aux CNR d'Innovation, Sciences et Développement économique Canada applicables aux appareils radio exempts de licence. L'exploitation est autorisée aux deux conditions suivantes :

- (1) L' appareil ne doit pas produire de brouillage;
- (2) L' appareil doit accepter tout brouillage radioélectrique subi, même si le brouillage est susceptible d' en compromettre le fonctionnement

Radio Frequency Exposure Statement for IC
This equipment complies with IC exposure limits set forth for an uncontrolled environment. This equipment shall be installed and operated with minimum distance 20cm between the radiator & body.

Cet équipement est conforme aux limites d'exposition IC définies pour un environnement non contrôlé. Cet équipement doit être installé et utilisé avec une distance minimale de 20cm entre le radiateur et la carrosserie.

Technical Support

If you need any technical help, please visit our official support site and contact our support team before returning the products, <https://support.reolink.com>



Simplified EU Declaration of Conformity

CE Statement

Hereby, EZTECH DIGITAL INC. declares that this device is in compliance with the essential requirements and other relevant provisions of Radio Equipment Directive (RED) 2014/53/EU. This product can be used across EU member states. This device can be used in European Union.

For EU:

Technology	Frequency MHz		RF Power	
	From	To	From	To
UTRA Band I	1920	1980	21.95dBm	
UTRA Band VIII	880	915	22.05dBm	
E-UTRA Band 1	1920	1980	23.93dBm	
E-UTRA Band 3	1710	1785	24.60dBm	
E-UTRA Band 7	2500	2570	23.53dBm	
E-UTRA Band 8	880	915	24.24dBm	
E-UTRA Band 20	832	862	23.10dBm	
E-UTRA Band 28	703	748	22.91dBm	