

FCC ID:2A49V-QE01D

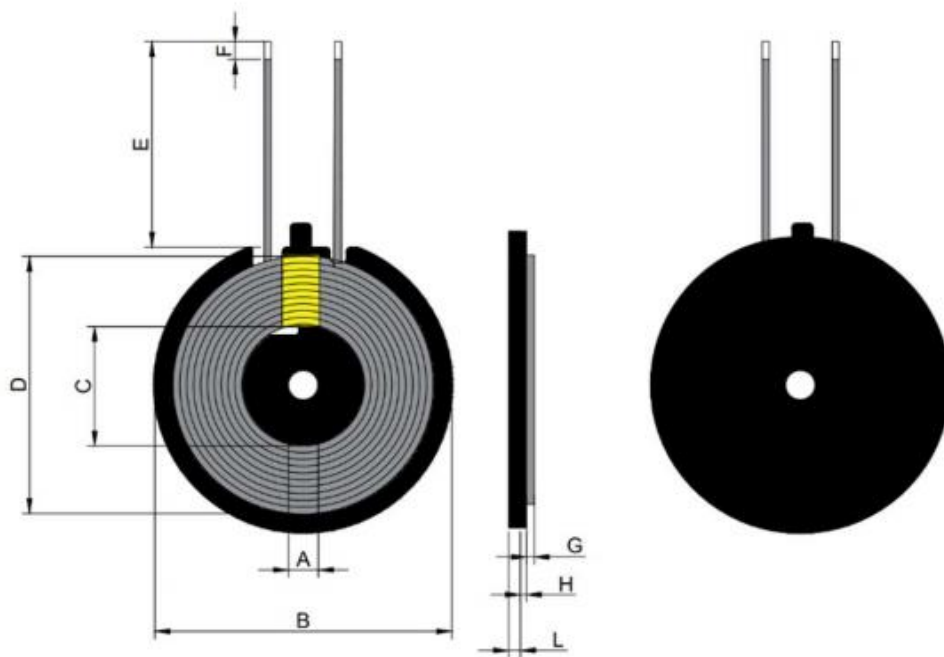
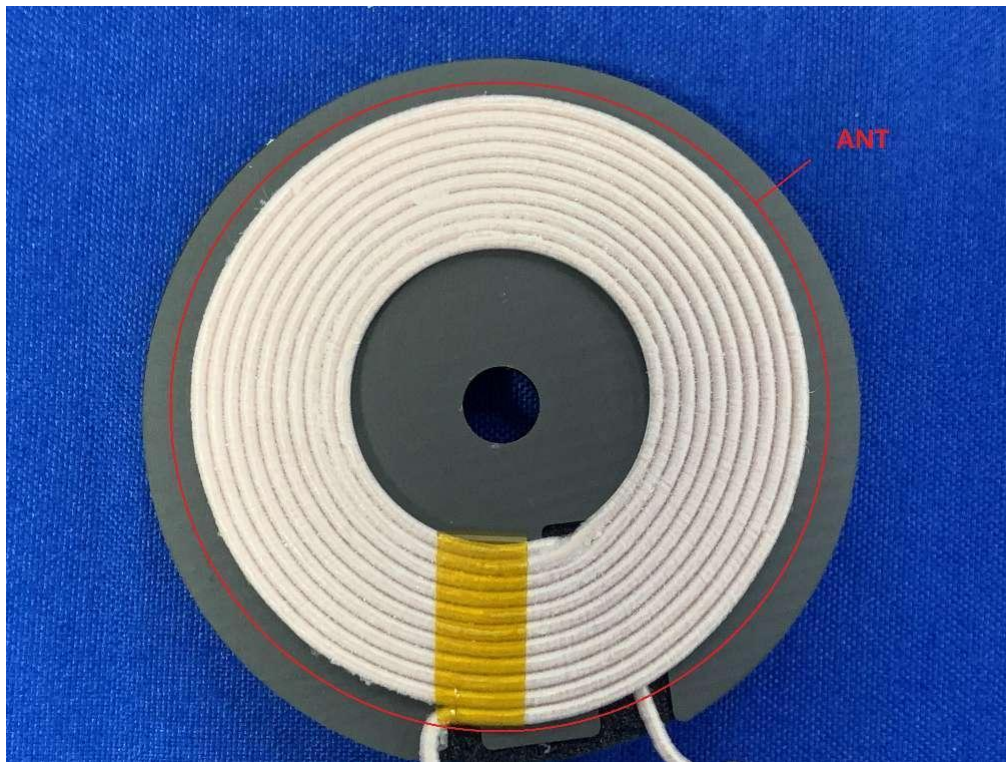

ANT information (MM)

Antenna Type	Coil antenna
Antenna Gain	0dBi
A	5.3 ± 0.1
B	50 ± 0.5
C	20.5 ± 0.5
D	42 ± 0.5
E	35 ± 1
F	3 ± 1
G	1.3 ± 0.1
H	0.8 ± 0.05
I	1 ± 0.1