

FCC TEST REPORT

FCC ID:2A48T-YET-M1

Report Number..... : ZKT-220223L0997E

Date of Test..... Feb. 22, 2022 to Mar. 01, 2022

Date of issue : Mar. 01, 2022

Total number of pages 38

Test Result : PASS

Testing Laboratory..... : Shenzhen ZKT Technology Co., Ltd.

Address : 1/F, No. 101, Building B, No. 6, Tangwei Community Industrial Avenue, Fuhai Street, Bao'an District, Shenzhen, China

Applicant's name : **Shenzhen Bo Lian Sheng Technology Co. LTD**

Address : Room 301, Floor 3, Building 1, Zone 2, Fumin Industrial Zone, Etian Second Road, Pinghu Street, Longgang District, Shenzhen

Manufacturer's name : **Shenzhen Bo Lian Sheng Technology Co. LTD**

Address : Room 301, Floor 3, Building 1, Zone 2, Fumin Industrial Zone, Etian Second Road, Pinghu Street, Longgang District, Shenzhen

Test specification:

Standard..... : FCC CFR Title 47 Part 15 Subpart C Section 15.249
ANSI C63.10:2013

Test procedure..... : /

Non-standard test method : N/A

Test Report Form No. : TRF-EL-111_V0**Test Report Form(s) Originator** : ZKT Testing**Master TRF** : Dated: 2022-02-23

This device described above has been tested by ZKT, and the test results show that the equipment under test (EUT) is in compliance with the FCC requirements. And it is applicable only to the tested sample identified in the report.

This report shall not be reproduced except in full, without the written approval of ZKT, this document may be altered or revised by ZKT, personal only, and shall be noted in the revision of the document.

Product name..... : USB receiver

Trademark : N/A

Model/Type reference : YET-M1

Battery..... : N/A

Ratings..... : DC 5V from Notebook, AC120V/60Hz for Notebook

Testing procedure and testing location:

Testing Laboratory: Shenzhen ZKT Technology Co., Ltd.

Address.....: 1/F, No. 101, Building B, No. 6, Tangwei Community
Industrial Avenue, Fuhai Street, Bao'an District,
Shenzhen, China

Tested by (name + signature): Alen He



Reviewer (name + signature).....: Joe Liu



Approved (name + signature): Lake Xie



Table of Contents

Page

| | |
|---|-----------|
| 1.VERSION | 5 |
| 2.1SUMMARY OF TEST RESULTS | 6 |
| 2.1.1 TEST FACILITY | 7 |
| 2.1.2 MEASUREMENT UNCERTAINTY | 7 |
| 3. GENERAL INFORMATION | 8 |
| 3.1 GENERAL DESCRIPTION OF EUT | 8 |
| 3.2 DESCRIPTION OF TEST MODES | 9 |
| 3.3 BLOCK DIGRAM SHOWING THE CONFIGURATION OF SYSTEM TESTED | 9 |
| 3.4 DESCRIPTION OF SUPPORT UNITS(CONDUCTED MODE) | 10 |
| 3.5 EQUIPMENTS LIST FOR ALL TEST ITEMS | 11 |
| 4. EMC EMISSION TEST | 12 |
| 4.1 CONDUCTED EMISSION MEASUREMENT | 12 |
| 4.1.1 POWER LINE CONDUCTED EMISSION LIMITS | 12 |
| 4.1.2 TEST PROCEDURE | 12 |
| 4.1.3 DEVIATION FROM TEST STANDARD | 12 |
| 4.1.4 1.3TEST SETUP | 12 |
| 4.1.5 EUT OPERATING CONDITIONS | 13 |
| 4.1.6 TEST RESULTS | 14 |
| 4.2 RADIATED EMISSION MEASUREMENT | 16 |
| 4.2.1 RADIATED EMISSION LIMITS | 16 |
| 4.2.2 TEST PROCEDURE | 17 |
| 4.2.3 1.4DEVIATION FROM TEST STANDARD | 17 |
| 4.2.4 TEST SETUP | 17 |
| 4.2.5 EUT OPERATING CONDITIONS | 18 |
| 5. BANDWIDTH OF FREQUENCY BAND EDGE | 29 |
| 5.1 TEST REQUIREMENT: | 29 |
| 5.2 TEST PROCEDURE | 29 |
| 5.3 DEVIATION FROM TEST STANDARD | 29 |
| 5.4 TEST SETUP | 29 |
| 5.5 EUT OPERATING CONDITIONS | 30 |
| 5.6 TEST RESULT | 31 |
| 6. CHANNEL BANDWIDTH | 33 |
| 6.1 APPLIED PROCEDURES / LIMIT | 33 |
| 6.2 TEST PROCEDURE | 33 |
| 6.3 DEVIATION FROM STANDARD | 33 |
| 6.4 TEST SETUP | 33 |

Table of Contents

| | Page |
|---------------------------------------|-------------|
| 6.5 EUT OPERATION CONDITIONS | 33 |
| 6.6 TSET RESULTS | 34 |
| 8.ANTENNA REQUIREMENT | 37 |
| 9. TEST SETUP PHOTO | 38 |
| 10. EUT CONSTRUCTIONAL DETAILS | 38 |

1.VERSION

| Report No. | Version | Description | Approved |
|------------------|---------|-------------------------|---------------|
| ZKT-220223L0997E | Rev.01 | Initial issue of report | Mar. 01, 2022 |
| | | | |
| | | | |

2.1 SUMMARY OF TEST RESULTS

Test procedures according to the technical standards:

| FCC Part15 (15.249) , Subpart C | | | |
|---------------------------------|--|----------|--------|
| Standard Section | Test Item | Judgment | Remark |
| FCC part 15.203 | Antenna requirement | PASS | |
| FCC part 15.207 | AC Power Line Conducted Emission | PASS | |
| FCC part 15.249 | Fundamental & Radiated Spurious Emission Measurement | PASS | |
| FCC part 15.215 (c) | 20dB Channel Bandwidth | PASS | |
| FCC part 15.205 | Band Edge | PASS | |

NOTE:

(1) "N/A" denotes test is not applicable in this Test Report

2.1.1 TEST FACILITY

Shenzhen ZKT Technology Co., Ltd.
Add. : 1/F, No. 101, Building B, No. 6, Tangwei Community Industrial Avenue, Fuhai Street, Bao'an District, Shenzhen, China

FCC Test Firm Registration Number: 692225
Designation Number: CN1299
IC Registered No.: 27033

2.1.2 MEASUREMENT UNCERTAINTY

The reported uncertainty of measurement $y \pm U$, where expanded uncertainty U is based on a standard uncertainty multiplied by a coverage factor of $k=2$, providing a level of confidence of approximately 95%.

| No. | Item | Uncertainty |
|-----|------------------------------|-------------------------|
| 1 | Conducted Emission Test | $\pm 1.38\text{dB}$ |
| 2 | RF power conducted | $\pm 0.16\text{dB}$ |
| 3 | Spurious emissions conducted | $\pm 0.21\text{dB}$ |
| 4 | All emissions radiated(<1G) | $\pm 4.68\text{dB}$ |
| 5 | All emissions radiated(>1G) | $\pm 4.89\text{dB}$ |
| 6 | Temperature | $\pm 0.5^\circ\text{C}$ |
| 7 | Humidity | $\pm 2\%$ |

3. GENERAL INFORMATION

3.1 GENERAL DESCRIPTION OF EUT

| | |
|--------------------------|---|
| Product Name: | USB receiver |
| Model No.: | YET-M1 |
| Model Different.: | N/A |
| Serial No.: | N/A |
| Hardware Version: | HV1.0 |
| Software Version: | SV1.0 |
| Sample(s) Status: | Engineer sample |
| Operation Frequency: | 2402MHz~2480MHz |
| Channel Numbers: | 79 |
| Channel Separation: | 1MHz |
| Modulation Type: | GFSK, $\pi/4$ -DQPSK, 8-DPSK |
| Antenna Type: | PCB Antenna |
| Antenna gain: | 0dBi |
| Power supply: | DC 5V from Notebook, AC120V/60Hz for Notebook |
| SWITCHING POWER ADAPTER: | N/A |
| Battery: | N/A |

| Operation frequency each of channel | | | | | | | |
|-------------------------------------|-----------|---------|-----------|---------|-----------|---------|-----------|
| Channel | Frequency | Channel | Frequency | Channel | Frequency | Channel | Frequency |
| 1 | 2402MHz | 21 | 2422MHz | 41 | 2442MHz | 61 | 2462MHz |
| 2 | 2403MHz | 22 | 2423MHz | 42 | 2443MHz | 62 | 2463MHz |
| 3 | 2404MHz | 23 | 2424MHz | 43 | 2444MHz | 63 | 2464MHz |
| 4 | 2405MHz | 24 | 2425MHz | 44 | 2445MHz | 64 | 2465MHz |
| 5 | 2406MHz | 25 | 2426MHz | 45 | 2446MHz | 65 | 2466MHz |
| 6 | 2407MHz | 26 | 2427MHz | 46 | 2447MHz | 66 | 2467MHz |
| 7 | 2408MHz | 27 | 2428MHz | 47 | 2448MHz | 67 | 2468MHz |
| 8 | 2409MHz | 28 | 2429MHz | 48 | 2449MHz | 68 | 2469MHz |
| 9 | 2410MHz | 29 | 2430MHz | 49 | 2450MHz | 69 | 2470MHz |
| 10 | 2411MHz | 30 | 2431MHz | 50 | 2451MHz | 70 | 2471MHz |
| 11 | 2412MHz | 31 | 2432MHz | 51 | 2452MHz | 71 | 2472MHz |
| 12 | 2413MHz | 32 | 2433MHz | 52 | 2453MHz | 72 | 2473MHz |
| 13 | 2414MHz | 33 | 2434MHz | 53 | 2454MHz | 73 | 2474MHz |
| 14 | 2415MHz | 34 | 2435MHz | 54 | 2455MHz | 74 | 2475MHz |

| | | | | | | | |
|----|---------|----|---------|----|---------|----|---------|
| 15 | 2416MHz | 35 | 2436MHz | 55 | 2456MHz | 75 | 2476MHz |
| 16 | 2417MHz | 36 | 2437MHz | 56 | 2457MHz | 76 | 2477MHz |
| 17 | 2418MHz | 37 | 2438MHz | 57 | 2458MHz | 77 | 2478MHz |
| 18 | 2419MHz | 38 | 2439MHz | 58 | 2459MHz | 78 | 2479MHz |
| 19 | 2420MHz | 39 | 2440MHz | 59 | 2460MHz | 79 | 2480MHz |
| 20 | 2421MHz | 40 | 2441MHz | 60 | 2461MHz | | |

Note:

In section 15.31(m), regards to the operating frequency range over 10 MHz, the Lowest frequency, the middle frequency, and the highest frequency of channel were selected to perform the test, and the selected channel see below:

| Channel | Frequency |
|---------------------|-----------|
| The lowest channel | 2402MHz |
| The middle channel | 2441MHz |
| The Highest channel | 2480MHz |

3.2 DESCRIPTION OF TEST MODES

| | |
|---|--|
| Transmitting mode | Keep the EUT in continuously transmitting mode |
| Remark: During the test, the test voltage was tuned from 85% to 115% of the nominal rated supply voltage, and found that the worst case was under the nominal rated supply condition. So the report just shows that condition's data. | |
| Enter test mode for the product, keep EUT in continuously transmitting status with hoping on mode with different packages; find the worst case is GFSK mode. | |

| | |
|-------------------|--------------|
| Test Software | BT Test Tool |
| Power level setup | <0dBm |

3.3 BLOCK DIGRAM SHOWING THE CONFIGURATION OF SYSTEM TESTED

Radiated Emission

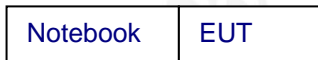

Conducted Spurious

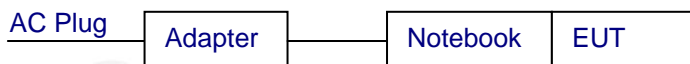

3.4 DESCRIPTION OF SUPPORT UNITS(CONDUCTED MODE)

The EUT has been tested as an independent unit together with other necessary accessories or support units. The following support units or accessories were used to form a representative test configuration during the tests.

| Item | Equipment | Mfr/Brand | Model/Type No. | Series No. | Note |
|------|--------------|-----------|----------------|------------|---------------|
| E-1 | USB receiver | N/A | LED Strip | N/A | EUT |
| E-2 | Notebook | ASUS | X401A | X16-96072 | Supply by Lab |
| E-3 | Adapter | ASUS | EXA0703YH | | Supply by Lab |
| | | | | | |
| | | | | | |

| Item | Shielded Type | Ferrite Core | Length | Note |
|------|---------------|--------------|--------|---------|
| C-1 | NO | NO | 1M | DC Line |
| | | | | |
| | | | | |

Note:

- (1) The support equipment was authorized by Declaration of Confirmation.
- (2) For detachable type I/O cable should be specified the length in cm in 『Length』 column.

3.5 EQUIPMENTS LIST FOR ALL TEST ITEMS
Radiation Test equipment

| Item | Equipment | Manufacturer | Type No. | Serial No. | Last calibration | Calibrated until |
|------|----------------------------------|-----------------|---------------------|------------|------------------|------------------|
| 1 | Spectrum Analyzer (9kHz-26.5GHz) | KEYSIGHT | 9020A | MY45109572 | Sep. 22, 2021 | Sep. 21, 2022 |
| 2 | Spectrum Analyzer (1GHz-40GHz) | Agilent | E4446A | 100363 | Sep. 22, 2021 | Sep. 21, 2022 |
| 3 | Test Receiver (9kHz-7GHz) | R&S | ESC17 | 101169 | Sep. 22, 2021 | Sep. 21, 2022 |
| 4 | Bilog Antenna (30MHz-1400MHz) | Schwarzbeck | VULB9168 | 00877 | Sep. 22, 2021 | Sep. 21, 2022 |
| 5 | Horn Antenna (1GHz-18GHz) | SCHWARZBEC K | BBHA9120D | 1541 | Sep. 22, 2021 | Sep. 21, 2022 |
| 6 | Horn Antenna (18GHz-40GHz) | A.H. System | SAS-574 | 588 | Sep. 22, 2021 | Sep. 21, 2022 |
| 7 | Amplifier (30-1000MHz) | EM Electronics | EM330 Amplifier | N/A | Sep. 22, 2021 | Sep. 21, 2022 |
| 8 | Amplifier (1GHz-40GHz) | 全聚达 | DLE-161 | 097 | Sep. 22, 2021 | Sep. 21, 2022 |
| 9 | Loop Antenna (9KHz-30MHz) | SCHWARZBEC K | FMZLED Strip519B | 014 | Sep. 22, 2021 | Sep. 21, 2022 |
| 10 | RF cables1 (9kHz-30MHz) | N/A | 9kHz-30MHz | N/A | Sep. 22, 2021 | Sep. 21, 2022 |
| 11 | RF cables2 (30MHz-1GHz) | N/A | 30MHz-1GHz | N/A | Sep. 22, 2021 | Sep. 21, 2022 |
| 12 | RF cables3 (1GHz-40GHz) | N/A | 1GHz-40GHz | N/A | Sep. 22, 2021 | Sep. 21, 2022 |
| 13 | CMW500 Test | R&S | CMW500 | 106504 | Sep. 22, 2021 | Sep. 21, 2022 |
| 14 | ESG Signal Generator | Agilent | E4421B | GB40051203 | Sep. 22, 2021 | Sep. 21, 2022 |
| 15 | Signal Generator | Agilent | N5182A | MY47420215 | Sep. 22, 2021 | Sep. 21, 2022 |
| 16 | D.C. Power Supply | LongWei | TPR-6405D | \ | \ | \ |
| 17 | Software | Frad | EZ-EMC | FA-03A2 RE | \ | \ |

Conduction Test equipment

| Item | Kind of Equipment | Manufacturer | Type No. | Serial No. | Last calibration | Calibrated until |
|------|-------------------|--------------|----------|-----------------|------------------|------------------|
| 1 | LISN | R&S | ENV216 | 101471 | Sep. 22, 2021 | Sep. 21, 2022 |
| 2 | LISN | CYBERTEK | EM5040A | E185040014 9 | Sep. 22, 2021 | Sep. 21, 2022 |
| 3 | Test Cable | N/A | C01 | N/A | Sep. 22, 2021 | Sep. 21, 2022 |
| 4 | Test Cable | N/A | C02 | N/A | Sep. 22, 2021 | Sep. 21, 2022 |
| 5 | EMI Test Receiver | R&S | ESRP3 | 101946 | Sep. 22, 2021 | Sep. 21, 2022 |
| 6 | Absorbing Clamp | DZ | ZN23201 | N/A | Sep. 22, 2021 | Sep. 21, 2022 |

4. EMC EMISSION TEST

4.1 CONDUCTED EMISSION MEASUREMENT

| | |
|-----------------------|--------------------------------------|
| Test Requirement: | FCC Part15 C Section 15.207 |
| Test Method: | ANSI C63.10:2013 |
| Test Frequency Range: | 150KHz to 30MHz |
| Receiver setup: | RBW=9KHz, VBW=30KHz, Sweep time=auto |

4.1.1 POWER LINE CONDUCTED EMISSION Limits

| FREQUENCY (MHz) | Limit (dBuV) | | Standard |
|-----------------|--------------|-----------|----------|
| | Quas -peak | Average | |
| 0.15 -0.5 | 66 - 56 * | 56 - 46 * | FCC |
| 0.50 -5.0 | 56.00 | 46.00 | FCC |
| 5.0 -30.0 | 60.00 | 50.00 | FCC |

Note:

(1) *Decreases with the logarithm of the frequency.

4.1.2 TEST PROCEDURE

- The EUT was placed 0.8 meters from the horizontal ground plane with EUT being connected to the power mains through a line impedance stabilization network (LISN). All other support equipments powered from additional LISN(s). The LISN provide 50 Ohm/ 50uH of coupling impedance for the measuring instrument.
- Interconnecting cables that hang closer than 40 cm to the ground plane shall be folded back and forth in the center forming a bundle 30 to 40 cm long.
- I/O cables that are not connected to a peripheral shall be bundled in the center. The end of the cable may be terminated, if required, using the correct terminating impedance. The overall length shall not exceed 1 m.
- LISN at least 80 cm from nearest part of EUT chassis.
- For the actual test configuration, please refer to the related Item –EUT Test Photos.

4.1.3 DEVIATION FROM TEST STANDARD

No deviation

4.1.4 TEST SETUP

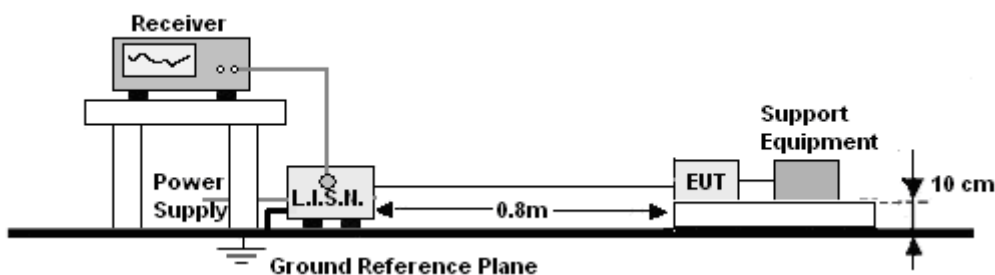

4.1.5 EUT OPERATING CONDITIONS

The EUT was configured for testing in a typical fashion (as a customer would normally use it). The EUT has been programmed to continuously transmit during test. This operating condition was tested and used to collect the included data.

We pretest AC 120V and AC 230V, the worst voltage was AC 120V and the data recording in the report.

4.1.6 TEST RESULTS

| | | | |
|----------------|--------------|--------------------|-----|
| Temperature : | 26°C | Relative Humidity: | 54% |
| Pressure : | 101kPa | Phase : | L |
| Test Voltage : | AC 120V/60Hz | | |

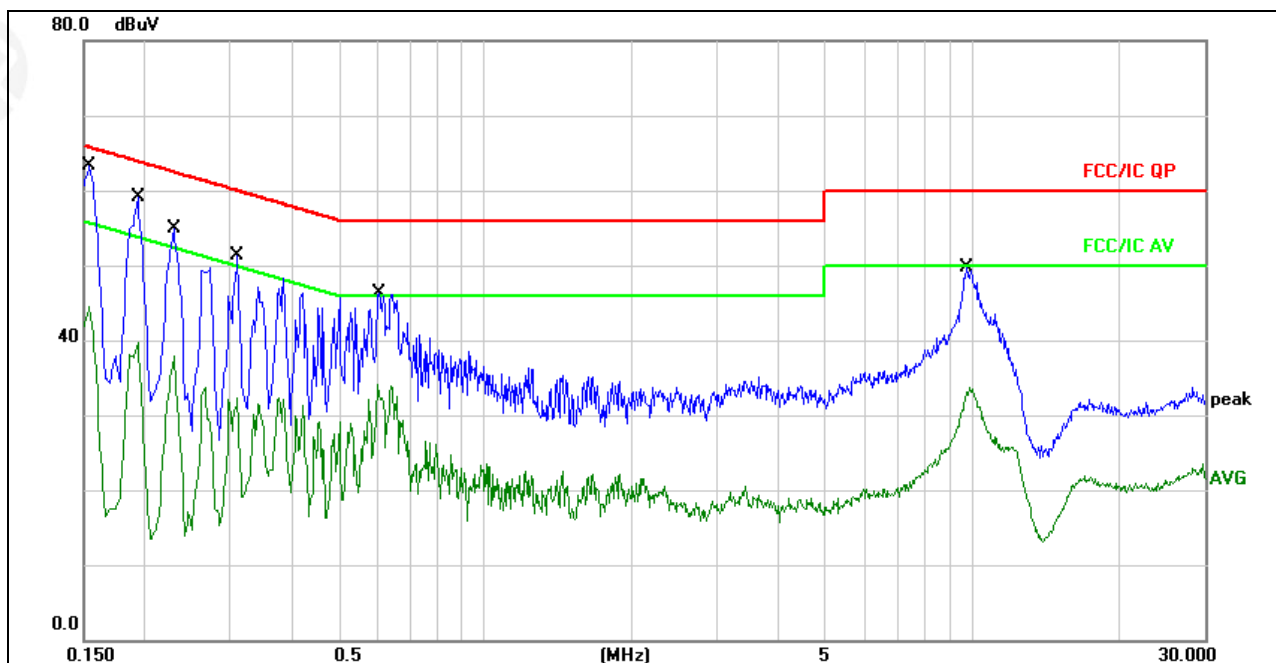

| No. | Mk. | Freq. | Reading Level | Correct Factor | Measurement | Limit | Over | Detector | Comment |
|-----|-----|--------|---------------|----------------|-------------|-------|--------|----------|---------|
| | | MHz | dBuV | dB | dBuV | dBuV | dB | | |
| 1 | * | 0.1539 | 53.70 | 9.67 | 63.37 | 65.78 | -2.41 | QP | |
| 2 | | 0.1539 | 34.81 | 9.67 | 44.48 | 55.78 | -11.30 | AVG | |
| 3 | | 0.1940 | 49.40 | 9.65 | 59.05 | 63.86 | -4.81 | QP | |
| 4 | | 0.1940 | 30.02 | 9.65 | 39.67 | 53.86 | -14.19 | AVG | |
| 5 | | 0.2300 | 45.16 | 9.65 | 54.81 | 62.45 | -7.64 | QP | |
| 6 | | 0.2300 | 28.16 | 9.65 | 37.81 | 52.45 | -14.64 | AVG | |
| 7 | | 0.3100 | 41.71 | 9.66 | 51.37 | 59.97 | -8.60 | QP | |
| 8 | | 0.3100 | 22.55 | 9.66 | 32.21 | 49.97 | -17.76 | AVG | |
| 9 | | 0.6020 | 38.03 | 9.68 | 47.71 | 56.00 | -8.29 | QP | |
| 10 | | 0.6020 | 24.45 | 9.68 | 34.13 | 46.00 | -11.87 | AVG | |
| 11 | | 9.7500 | 39.86 | 9.82 | 49.68 | 60.00 | -10.32 | QP | |
| 12 | | 9.7500 | 23.87 | 9.82 | 33.69 | 50.00 | -16.31 | AVG | |

Notes:

1. An initial pre-scan was performed on the line and neutral lines with peak detector.
2. Quasi-Peak and Average measurement were performed at the frequencies with maximized peak emission.
3. Measurement Level = Reading level + Correct Factor

| | | | |
|----------------|--------------|--------------------|-----|
| Temperature : | 26°C | Relative Humidity: | 54% |
| Pressure : | 101kPa | Phase : | N |
| Test Voltage : | AC 120V/60Hz | | |

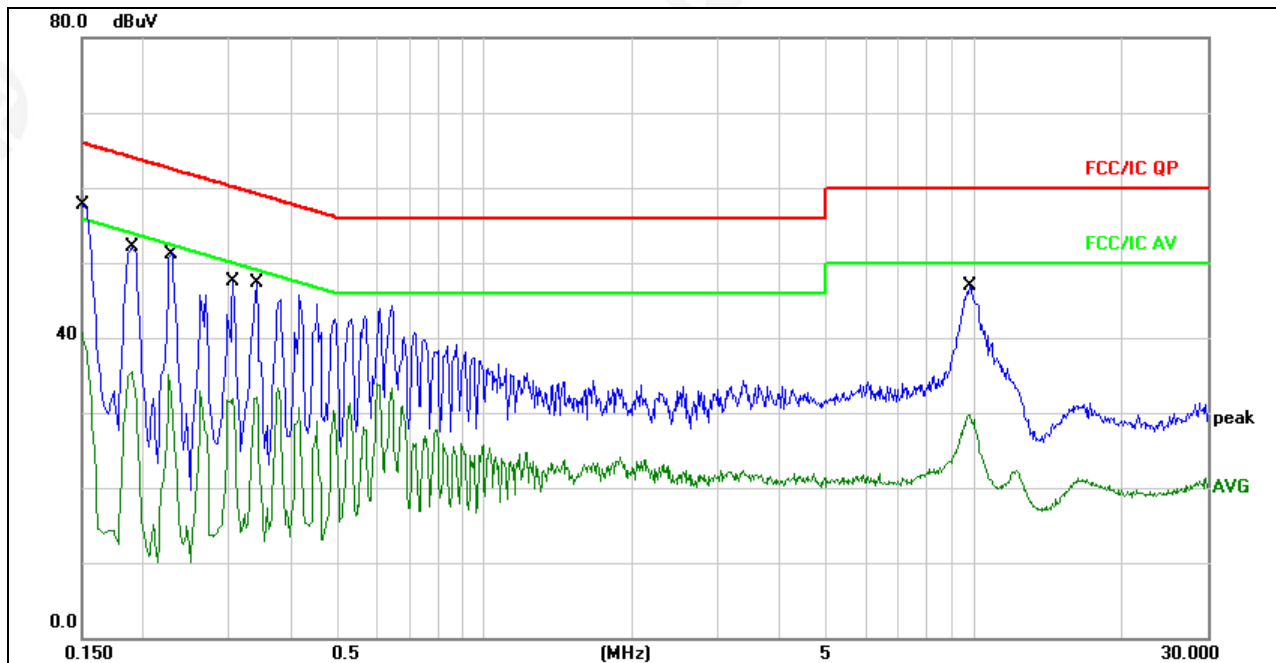

| No. | Mk. | Freq. MHz | Reading Level dBuV | Correct Factor dB | Measure- ment dBuV | Limit dBuV | Over dB | Detector | Comment |
|-----|-----|--------------|--------------------------|-------------------------|--------------------------|---------------|------------|----------|---------|
| 1 | * | 0.1500 | 48.08 | 9.67 | 57.75 | 65.99 | -8.24 | QP | |
| 2 | | 0.1500 | 30.93 | 9.67 | 40.60 | 55.99 | -15.39 | AVG | |
| 3 | | 0.1900 | 42.36 | 9.65 | 52.01 | 64.03 | -12.02 | QP | |
| 4 | | 0.1900 | 25.78 | 9.65 | 35.43 | 54.03 | -18.60 | AVG | |
| 5 | | 0.2260 | 41.64 | 9.65 | 51.29 | 62.59 | -11.30 | QP | |
| 6 | | 0.2260 | 25.39 | 9.65 | 35.04 | 52.59 | -17.55 | AVG | |
| 7 | | 0.3060 | 37.92 | 9.66 | 47.58 | 60.08 | -12.50 | QP | |
| 8 | | 0.3060 | 22.34 | 9.66 | 32.00 | 50.08 | -18.08 | AVG | |
| 9 | | 0.3420 | 37.56 | 9.66 | 47.22 | 59.15 | -11.93 | QP | |
| 10 | | 0.3420 | 22.38 | 9.66 | 32.04 | 49.15 | -17.11 | AVG | |
| 11 | | 9.7860 | 36.99 | 9.82 | 46.81 | 60.00 | -13.19 | QP | |
| 12 | | 9.7860 | 19.83 | 9.82 | 29.65 | 50.00 | -20.35 | AVG | |

Notes:

- 1.An initial pre-scan was performed on the line and neutral lines with peak detector.
- 2.Quasi-Peak and Average measurement were performed at the frequencies with maximized peak emission.
- 3.Measurement Level = Reading level + Correct Factor

4.2 RADIATED EMISSION MEASUREMENT

| | | | | | |
|-----------------------|-----------------------------|------------|--------|---------|------------|
| Test Requirement: | FCC Part15 C Section 15.209 | | | | |
| Test Method: | ANSI C63.10:2013 | | | | |
| Test Frequency Range: | 9kHz to 25GHz | | | | |
| Test site: | Measurement Distance: 3m | | | | |
| Receiver setup: | Frequency | Detector | RBW | VBW | Value |
| | 9KHz-150KHz | Quasi-peak | 200Hz | 600Hz | Quasi-peak |
| | 150KHz-30MHz | Quasi-peak | 9KHz | 30KHz | Quasi-peak |
| | 30MHz-1GHz | Quasi-peak | 100KHz | 300KHz | Quasi-peak |
| | Above 1GHz | Peak | 1MHz | 3MHz | Peak |
| Peak | | 1MHz | 10Hz | Average | |

4.2.1 RADIATED EMISSION LIMITS

| Frequencies (MHz) | Field Strength (micorvolts/meter) | Measurement Distance (meters) |
|-------------------|-----------------------------------|-------------------------------|
| 0.009~0.490 | 2400/F(KHz) | 300 |
| 0.490~1.705 | 24000/F(KHz) | 30 |
| 1.705~30.0 | 30 | 30 |
| 30~88 | 100 | 3 |
| 88~216 | 150 | 3 |
| 216~960 | 200 | 3 |
| Above 960 | 500 | 3 |

The field strength of emissions from intentional radiators operated within these frequency bands shall comply with the following:

| Fundamental frequency | Field strength of fundamental (millivolts/meter) | Field strength of harmonics (microvolts/meter) |
|-----------------------|--|--|
| 902-928 MHz | 50 | 500 |
| 2400-2483.5 MHz | 50 | 500 |
| 5725-5875 MHz | 50 | 500 |
| 24.0-24.25 GHz | 250 | 2500 |

LIMITS OF RADIATED EMISSION MEASUREMENT

| FREQUENCY (MHz) | Limit (dBuV/m) (at 3M) | |
|-----------------|------------------------|---------|
| | PEAK | AVERAGE |
| Above 1000 | 74 | 54 |

Notes:

- (1) The limit for radiated test was performed according to FCC PART 15C.

- (2) The tighter limit applies at the band edges.
- (3) Emission level (dBuV/m)=20log Emission level (uV/m).

4.2.2 TEST PROCEDURE

- a. The measuring distance of at 3 m shall be used for measurements at frequency up to 25GHz. For frequencies above 1GHz, any suitable measuring distance may be used.
- b. The EUT was placed on the top of a rotating table 0.8 meters above the ground at a 3 meter semi-chamber test. The table was rotated 360 degrees to determine the position of the highest radiation.
- c. The height of the equipment or of the substitution antenna shall be 0.8m; above 1GHz, the height was 1.5m, the height of the test antenna shall vary between 1 m to 4 m. Both horizontal and vertical polarizations of the antenna are set to make the measurement.
- d. The initial step in collecting conducted emission data is a spectrum analyzer peak detector mode pre-scanning the measurement frequency range. Significant peaks are then marked and then Quasi Peak detector mode re-measured.
- e. If the Peak Mode measured value compliance with and lower than Quasi Peak Mode Limit, the EUT shall be deemed to meet QP Limits and then no additional QP Mode measurement performed.
- f. For the actual test configuration, please refer to the related Item –EUT Test Photos.
- g. For the radiated emission test above 1GHz:
Place the measurement antenna away from each area of the EUT determined to be a source of emissions at the specified measurement distance, while keeping the measurement antenna aimed at the source of emissions at each frequency of significant emissions, with polarization oriented for maximum response.
The measurement antenna may have to be higher or lower than the EUT, depending on the radiation pattern of the emission and staying aimed at the emission source for receiving the maximum signal. The final measurement antenna elevation shall be that which maximizes the emissions. The measurement antenna elevation for maximum emissions shall be restricted to a range of heights of from 1 m to 4 m above the ground or reference ground plane.

Note:

Both horizontal and vertical antenna polarities were tested and performed pretest to three orthogonal axis. The worst case emissions were reported

4.2.3 DEVIATION FROM TEST STANDARD

No deviation

4.2.4 TEST SETUP

(A) Radiated Emission Test-Up Frequency Below 30MHz

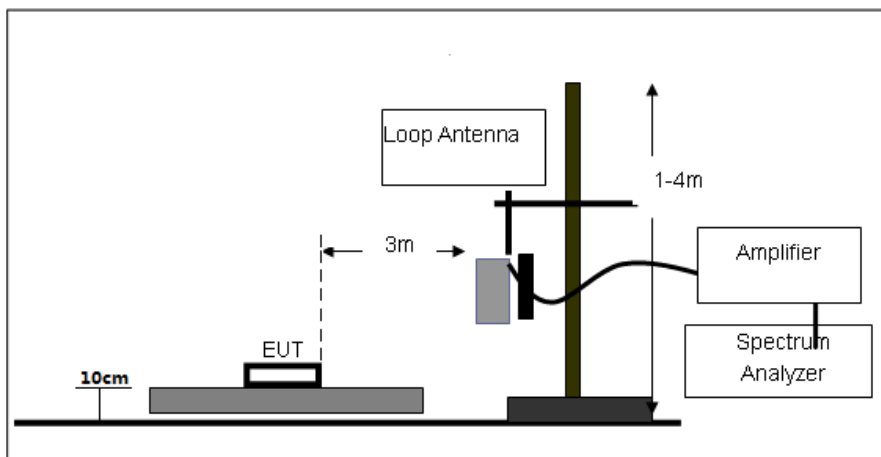

(B) Radiated Emission Test-Up Frequency 30MHz~1GHz

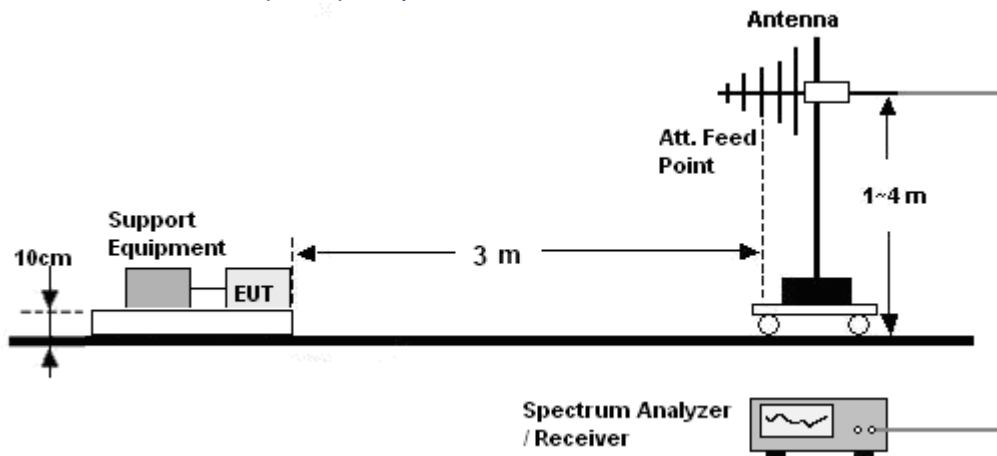

(C) Radiated Emission Test-Up Frequency Above 1GHz

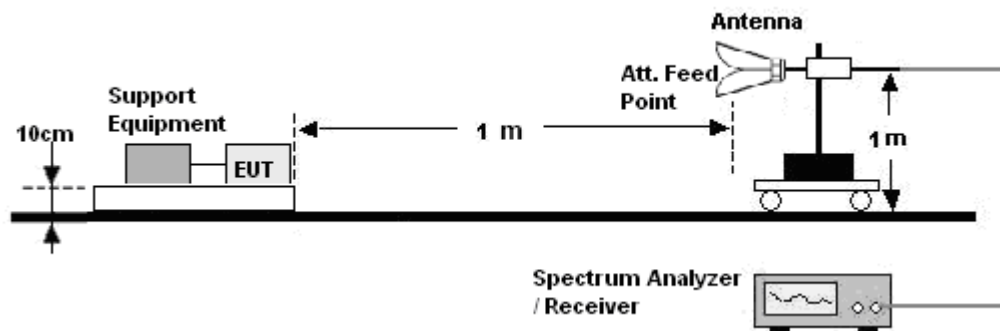

4.2.5 EUT OPERATING CONDITIONS

The EUT tested system was configured as the statements of 2.4 Unless otherwise a special operating condition is specified in the follows during the testing.

4.2.6 TEST RESULTS (Between 9KHz – 30 MHz)

The emission from 9 kHz to 30MHz was pre-tested and found the result was 20dB lower than the limit, and according to 15.31(o) & RSS-Gen 6.13, the test result no need to reported.

Between 30MHz – 1GHz

| | | | |
|---------------|--------------|--------------------|------------|
| Temperature: | 26°C | Relative Humidity: | 54% |
| Pressure: | 101 kPa | Polarization: | Horizontal |
| Test Voltage: | AC 120V/60Hz | | |

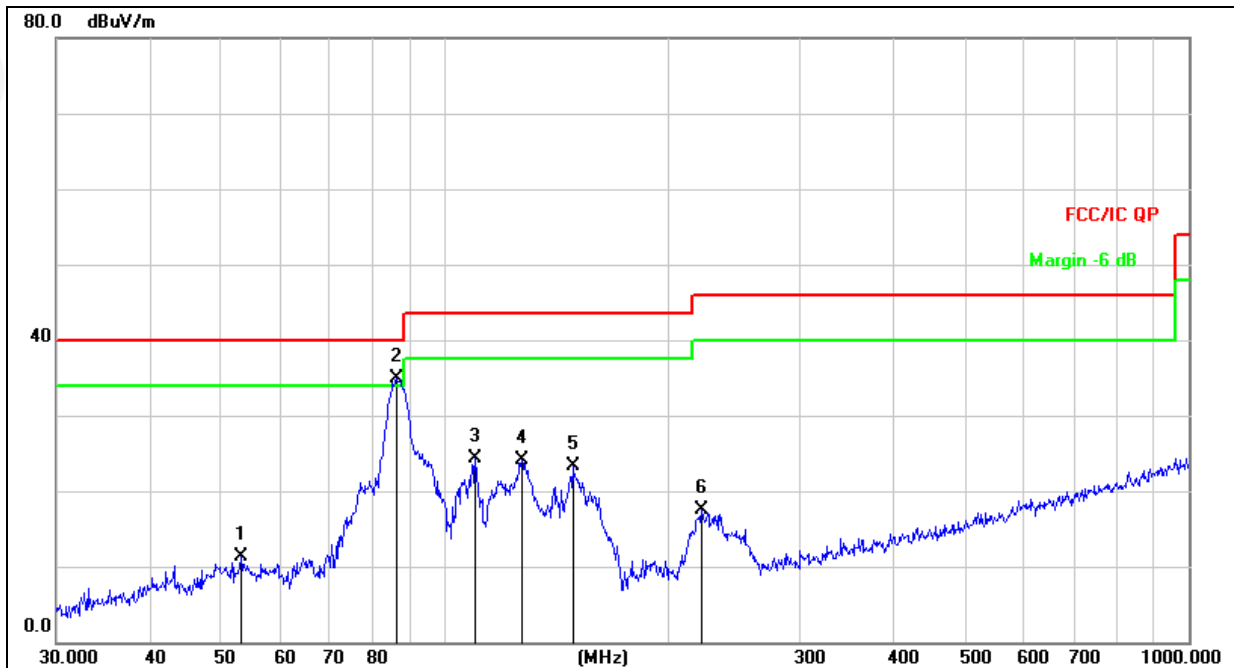

| No. | Mk. | Freq. MHz | Reading Level dBuV | Correct Factor dB | Measure- ment dBuV/m | Limit dB/m | Over dB | Detector |
|-----|-----|--------------|--------------------------|-------------------------|----------------------------|---------------|------------|----------|
| 1 | | 53.1313 | 26.06 | -14.82 | 11.24 | 40.00 | -28.76 | QP |
| 2 | * | 85.8984 | 54.35 | -19.39 | 34.96 | 40.00 | -5.04 | QP |
| 3 | | 109.7960 | 40.68 | -16.46 | 24.22 | 43.50 | -19.28 | QP |
| 4 | | 126.7723 | 43.46 | -19.28 | 24.18 | 43.50 | -19.32 | QP |
| 5 | | 148.4410 | 42.95 | -19.72 | 23.23 | 43.50 | -20.27 | QP |
| 6 | | 221.3921 | 32.84 | -15.26 | 17.58 | 46.00 | -28.42 | QP |

| | | | |
|---------------|-------------|--------------------|----------|
| Temperature: | 26°C | Relative Humidity: | 54% |
| Pressure: | 101kPa | Polarization: | Vertical |
| Test Voltage: | AC120V/60Hz | | |

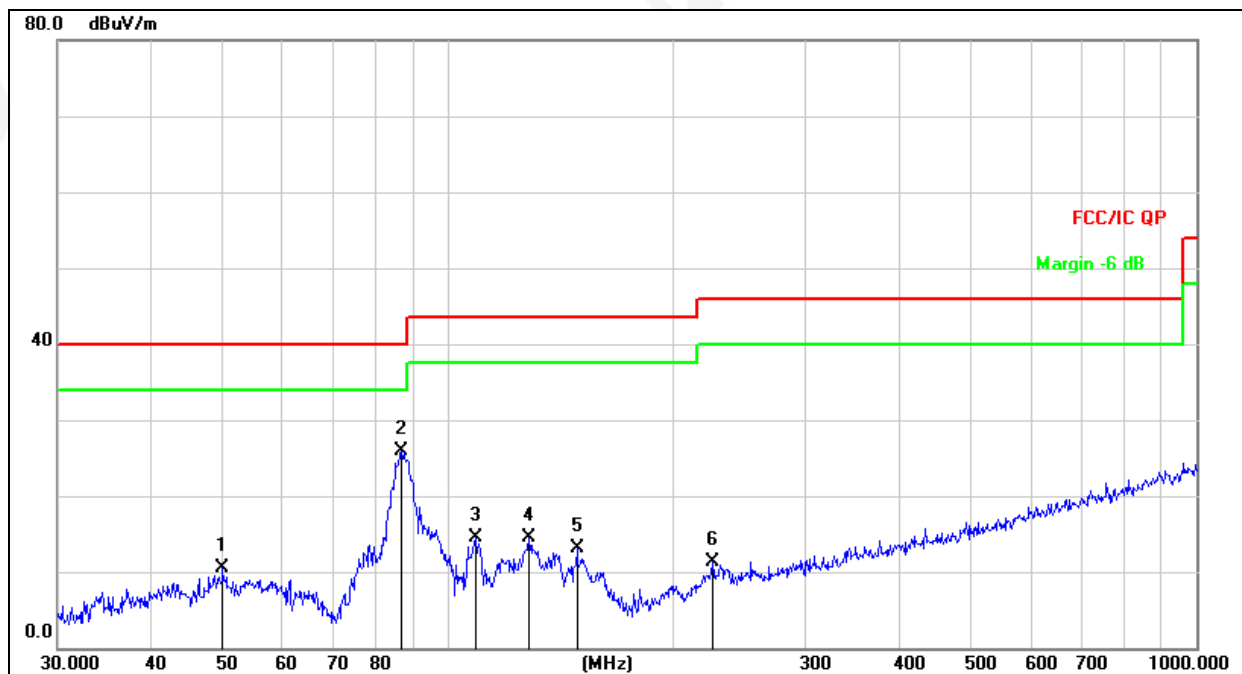

| No. | Mk. | Freq. MHz | Reading Level dBuV | Correct Factor dB | Measure- ment dBuV/m | Limit dB/m | Over dB | Detector |
|-----|-----|--------------|--------------------------|-------------------------|----------------------------|---------------|------------|----------|
| 1 | | 49.8814 | 25.20 | -14.75 | 10.45 | 40.00 | -29.55 | QP |
| 2 | * | 86.5029 | 45.09 | -19.21 | 25.88 | 40.00 | -14.12 | QP |
| 3 | | 108.6470 | 30.96 | -16.38 | 14.58 | 43.50 | -28.92 | QP |
| 4 | | 128.1130 | 33.95 | -19.39 | 14.56 | 43.50 | -28.94 | QP |
| 5 | | 148.4410 | 32.79 | -19.72 | 13.07 | 43.50 | -30.43 | QP |
| 6 | | 225.3080 | 26.20 | -14.93 | 11.27 | 46.00 | -34.73 | QP |

Remarks:

- 1.Final Level =Receiver Read level + Antenna Factor + Cable Loss – Preamplifier Factor
- 2.The emission levels of other frequencies are very lower than the limit and not show in test report.

Field Strength of The Fundamental Signal
GFSK
Peak value:

| Frequency (MHz) | Read Level (dBuV) | Antenna Factor (dB/m) | Cable Loss (dB) | Preamp Factor (dB) | Level (dBuV/m) | Limit Line (dBuV/m) | Over Limit (dB) | polarization |
|-----------------|-------------------|-----------------------|-----------------|--------------------|----------------|---------------------|-----------------|--------------|
| 2402.00 | 92.01 | 27.26 | 5.39 | 30.18 | 94.48 | 114.00 | -19.52 | Vertical |
| 2402.00 | 91.67 | 27.26 | 5.39 | 30.18 | 94.14 | 114.00 | -19.86 | Horizontal |
| 2441.00 | 89.89 | 27.33 | 5.43 | 30.06 | 92.59 | 114.00 | -21.41 | Vertical |
| 2441.00 | 84.66 | 27.33 | 5.43 | 30.06 | 87.36 | 114.00 | -26.64 | Horizontal |
| 2480.00 | 90.85 | 27.40 | 5.47 | 29.93 | 93.79 | 114.00 | -20.21 | Vertical |
| 2480.00 | 88.42 | 27.40 | 5.47 | 29.93 | 91.36 | 114.00 | -22.64 | Horizontal |

adAverage value:

| Frequency (MHz) | Read Level (dBuV) | Antenna Factor (dB/m) | Cable Loss (dB) | Preamp Factor (dB) | Level (dBuV/m) | Limit Line (dBuV/m) | Over Limit (dB) | polarization |
|-----------------|-------------------|-----------------------|-----------------|--------------------|----------------|---------------------|-----------------|--------------|
| 2402.00 | 78.42 | 27.26 | 5.39 | 30.18 | 80.89 | 94.00 | -13.11 | Vertical |
| 2402.00 | 76.35 | 27.26 | 5.39 | 30.18 | 78.82 | 94.00 | -15.18 | Horizontal |
| 2441.00 | 75.58 | 27.33 | 5.43 | 30.06 | 78.28 | 94.00 | -15.72 | Vertical |
| 2441.00 | 71.20 | 27.33 | 5.43 | 30.06 | 73.90 | 94.00 | -20.10 | Horizontal |
| 2480.00 | 79.12 | 27.40 | 5.47 | 29.93 | 82.06 | 94.00 | -11.94 | Vertical |
| 2480.00 | 76.09 | 27.40 | 5.47 | 29.93 | 79.03 | 94.00 | -14.97 | Horizontal |

 $\pi/4$ -DQPSK
Peak value:

| Frequency (MHz) | Read Level (dBuV) | Antenna Factor (dB/m) | Cable Loss (dB) | Preamp Factor (dB) | Level (dBuV/m) | Limit Line (dBuV/m) | Over Limit (dB) | polarization |
|-----------------|-------------------|-----------------------|-----------------|--------------------|----------------|---------------------|-----------------|--------------|
| 2402.00 | 91.74 | 27.26 | 5.39 | 30.18 | 94.21 | 114.00 | -19.79 | Vertical |
| 2402.00 | 90.67 | 27.26 | 5.39 | 30.18 | 93.14 | 114.00 | -20.86 | Horizontal |
| 2441.00 | 90.31 | 27.33 | 5.43 | 30.06 | 93.01 | 114.00 | -20.99 | Vertical |
| 2441.00 | 84.45 | 27.33 | 5.43 | 30.06 | 87.15 | 114.00 | -26.85 | Horizontal |
| 2480.00 | 90.70 | 27.40 | 5.47 | 29.93 | 93.64 | 114.00 | -20.36 | Vertical |
| 2480.00 | 87.43 | 27.40 | 5.47 | 29.93 | 90.37 | 114.00 | -23.63 | Horizontal |

Average value:

| Frequency (MHz) | Read Level (dBuV) | Antenna Factor (dB/m) | Cable Loss (dB) | Preamp Factor (dB) | Level (dBuV/m) | Limit Line (dBuV/m) | Over Limit (dB) | polarization |
|-----------------|-------------------|-----------------------|-----------------|--------------------|----------------|---------------------|-----------------|--------------|
| 2402.00 | 81.00 | 27.26 | 5.39 | 30.18 | 83.47 | 94.00 | -10.53 | Vertical |
| 2402.00 | 78.92 | 27.26 | 5.39 | 30.18 | 81.39 | 94.00 | -12.61 | Horizontal |
| 2441.00 | 77.54 | 27.33 | 5.43 | 30.06 | 80.24 | 94.00 | -13.76 | Vertical |
| 2441.00 | 74.21 | 27.33 | 5.43 | 30.06 | 76.91 | 94.00 | -17.09 | Horizontal |
| 2480.00 | 82.12 | 27.40 | 5.47 | 29.93 | 85.06 | 94.00 | -8.94 | Vertical |
| 2480.00 | 78.31 | 27.40 | 5.47 | 29.93 | 81.25 | 94.00 | -12.75 | Horizontal |

8-DPSK

Peak value:

| Frequency (MHz) | Read Level (dBuV) | Antenna Factor (dB/m) | Cable Loss (dB) | Preamp Factor (dB) | Level (dBuV/m) | Limit Line (dBuV/m) | Over Limit (dB) | polarization |
|-----------------|-------------------|-----------------------|-----------------|--------------------|----------------|---------------------|-----------------|--------------|
| 2402.00 | 81.42 | 27.26 | 5.39 | 30.18 | 83.89 | 114.00 | -30.11 | Vertical |
| 2402.00 | 91.96 | 27.26 | 5.39 | 30.18 | 94.43 | 114.00 | -19.57 | Horizontal |
| 2441.00 | 90.79 | 27.33 | 5.43 | 30.06 | 93.49 | 114.00 | -20.51 | Vertical |
| 2441.00 | 90.66 | 27.33 | 5.43 | 30.06 | 93.36 | 114.00 | -20.64 | Horizontal |
| 2480.00 | 84.93 | 27.40 | 5.47 | 29.93 | 87.87 | 114.00 | -26.13 | Vertical |
| 2480.00 | 92.22 | 27.40 | 5.47 | 29.93 | 95.16 | 114.00 | -18.84 | Horizontal |

Average value:

| Frequency (MHz) | Read Level (dBuV) | Antenna Factor (dB/m) | Cable Loss (dB) | Preamp Factor (dB) | Level (dBuV/m) | Limit Line (dBuV/m) | Over Limit (dB) | polarization |
|-----------------|-------------------|-----------------------|-----------------|--------------------|----------------|---------------------|-----------------|--------------|
| 2402.00 | 81.91 | 27.26 | 5.39 | 30.18 | 84.38 | 94.00 | -9.62 | Vertical |
| 2402.00 | 79.50 | 27.26 | 5.39 | 30.18 | 81.97 | 94.00 | -12.03 | Horizontal |
| 2441.00 | 78.93 | 27.33 | 5.43 | 30.06 | 81.63 | 94.00 | -12.37 | Vertical |
| 2441.00 | 75.25 | 27.33 | 5.43 | 30.06 | 77.95 | 94.00 | -16.05 | Horizontal |
| 2480.00 | 81.82 | 27.40 | 5.47 | 29.93 | 84.76 | 94.00 | -9.24 | Vertical |
| 2480.00 | 79.34 | 27.40 | 5.47 | 29.93 | 82.28 | 94.00 | -11.72 | Horizontal |

GFSK

| Polar (H/V) | Frequency | Meter Reading | Pre-amplifier | Cable Loss | Antenna Factor | Emission Level | Limits | Margin | Detector Type |
|---------------------|-----------|---------------|---------------|------------|----------------|----------------|----------|--------|---------------|
| | (MHz) | (dBuV) | (dB) | (dB) | (dB) | (dBuV/m) | (dBuV/m) | (dB) | |
| Low Channel:2402MHz | | | | | | | | | |
| V | 4804.00 | 50.79 | 30.55 | 5.77 | 31.12 | 57.13 | 74.00 | -16.87 | Pk |
| V | 4804.00 | 30.51 | 30.55 | 5.77 | 31.12 | 36.85 | 54.00 | -17.15 | AV |
| V | 7206.00 | 48.95 | 30.33 | 6.32 | 36.04 | 60.98 | 74.00 | -13.02 | Pk |
| V | 7206.00 | 31.42 | 30.33 | 6.32 | 36.04 | 43.45 | 54.00 | -10.55 | AV |
| V | 9608.00 | 49.94 | 30.85 | 7.45 | 37.58 | 64.12 | 74.00 | -9.88 | Pk |
| V | 9608.00 | 30.62 | 30.85 | 7.45 | 37.58 | 44.80 | 54.00 | -9.20 | AV |
| V | 12010.00 | 49.56 | 31.02 | 8.99 | 39.10 | 66.63 | 74.00 | -7.37 | Pk |
| V | 12010.00 | 31.02 | 31.02 | 8.99 | 39.10 | 48.09 | 54.00 | -5.91 | AV |
| H | 4804.00 | 51.22 | 30.55 | 5.77 | 31.12 | 57.56 | 74.00 | -16.44 | Pk |
| H | 4804.00 | 31.34 | 30.55 | 5.77 | 31.12 | 37.68 | 54.00 | -16.32 | AV |
| H | 7206.00 | 49.80 | 30.33 | 6.32 | 36.04 | 61.83 | 74.00 | -12.17 | Pk |
| H | 7206.00 | 30.99 | 30.33 | 6.32 | 36.04 | 43.02 | 54.00 | -10.98 | AV |
| H | 9608.00 | 50.13 | 30.85 | 7.45 | 37.58 | 64.31 | 74.00 | -9.69 | Pk |
| H | 9608.00 | 30.73 | 30.85 | 7.45 | 37.58 | 44.91 | 54.00 | -9.09 | AV |
| H | 12010.00 | 48.43 | 31.02 | 8.99 | 39.10 | 65.50 | 74.00 | -8.50 | Pk |
| H | 12010.00 | 30.17 | 31.02 | 8.99 | 39.10 | 47.24 | 54.00 | -6.76 | AV |

| Polar (H/V) | Frequency | Meter Reading | Pre-amplifier | Cable Loss | Antenna Factor | Emission Level | Limits | Margin | Detector Type |
|------------------------|-----------|---------------|---------------|------------|----------------|----------------|----------|--------|---------------|
| | (MHz) | (dBuV) | (dB) | (dB) | (dB) | (dBuV/m) | (dBuV/m) | (dB) | |
| Middle Channel:2441MHz | | | | | | | | | |
| V | 4882.00 | 50.24 | 30.55 | 5.77 | 31.46 | 56.92 | 74.00 | -17.08 | Pk |
| V | 4882.00 | 31.20 | 30.55 | 5.77 | 31.46 | 37.88 | 54.00 | -16.12 | AV |
| V | 7323.00 | 48.77 | 30.33 | 6.32 | 36.15 | 60.91 | 74.00 | -13.09 | Pk |
| V | 7323.00 | 30.11 | 30.33 | 6.32 | 36.15 | 42.25 | 54.00 | -11.75 | AV |
| V | 9764.00 | 48.74 | 30.85 | 7.45 | 37.76 | 63.10 | 74.00 | -10.90 | Pk |
| V | 9764.00 | 30.21 | 30.85 | 7.45 | 37.76 | 44.57 | 54.00 | -9.43 | AV |
| V | 12205.00 | 48.54 | 31.02 | 8.99 | 39.10 | 65.61 | 74.00 | -8.39 | Pk |
| V | 12205.00 | 30.97 | 31.02 | 8.99 | 39.10 | 48.04 | 54.00 | -5.96 | AV |
| H | 4882.00 | 51.30 | 30.55 | 5.77 | 31.46 | 57.98 | 74.00 | -16.02 | Pk |
| H | 4882.00 | 31.23 | 30.55 | 5.77 | 31.46 | 37.91 | 54.00 | -16.09 | AV |
| H | 7323.00 | 52.41 | 30.33 | 6.32 | 36.15 | 64.55 | 74.00 | -9.45 | Pk |
| H | 7323.00 | 30.94 | 30.33 | 6.32 | 36.15 | 43.08 | 54.00 | -10.92 | AV |
| H | 9764.00 | 52.35 | 30.85 | 7.45 | 37.76 | 66.71 | 74.00 | -7.29 | Pk |
| H | 9764.00 | 31.04 | 30.85 | 7.45 | 37.76 | 45.40 | 54.00 | -8.60 | AV |
| H | 12205.00 | 48.71 | 31.02 | 8.99 | 39.10 | 65.78 | 74.00 | -8.22 | Pk |
| H | 12205.00 | 30.24 | 31.02 | 8.99 | 39.10 | 47.31 | 54.00 | -6.69 | AV |

| Polar (H/V) | Frequency | Meter Reading | Pre-amplifier | Cable Loss | Antenna Factor | Emission Level | Limits | Margin | Detector Type |
|----------------------|-----------|---------------|---------------|------------|----------------|----------------|----------|--------|---------------|
| | (MHz) | (dBuV) | (dB) | (dB) | (dB) | (dBuV/m) | (dBuV/m) | (dB) | |
| High Channel:2480MHz | | | | | | | | | |
| V | 4960.00 | 48.96 | 30.55 | 5.77 | 31.79 | 55.97 | 74.00 | -18.03 | Pk |
| V | 4960.00 | 30.45 | 30.55 | 5.77 | 31.79 | 37.46 | 54.00 | -16.54 | AV |
| V | 7440.00 | 51.48 | 30.33 | 6.32 | 36.38 | 63.85 | 74.00 | -10.15 | Pk |
| V | 7440.00 | 31.27 | 30.33 | 6.32 | 36.38 | 43.64 | 54.00 | -10.36 | AV |
| V | 9920.00 | 51.50 | 30.85 | 7.45 | 36.50 | 64.60 | 74.00 | -9.40 | Pk |
| V | 9920.00 | 31.16 | 30.85 | 7.45 | 36.50 | 44.26 | 54.00 | -9.74 | AV |
| V | 12400.00 | 51.46 | 31.02 | 8.99 | 39.11 | 68.54 | 74.00 | -5.46 | Pk |
| V | 12400.00 | 31.36 | 31.02 | 8.99 | 39.11 | 48.44 | 54.00 | -5.56 | AV |
| H | 4960.00 | 49.07 | 30.55 | 5.77 | 31.79 | 56.08 | 74.00 | -17.92 | Pk |
| H | 4960.00 | 30.77 | 30.55 | 5.77 | 31.79 | 37.78 | 54.00 | -16.22 | AV |
| H | 7440.00 | 51.09 | 30.33 | 6.32 | 36.38 | 63.46 | 74.00 | -10.54 | Pk |
| H | 7440.00 | 30.73 | 30.33 | 6.32 | 36.38 | 43.10 | 54.00 | -10.90 | AV |
| H | 9920.00 | 51.32 | 30.85 | 7.45 | 36.50 | 64.42 | 74.00 | -9.58 | Pk |
| H | 9920.00 | 30.73 | 30.85 | 7.45 | 36.50 | 43.83 | 54.00 | -10.17 | AV |
| H | 12400.00 | 51.14 | 31.02 | 8.99 | 39.11 | 68.22 | 74.00 | -5.78 | Pk |
| H | 12400.00 | 30.83 | 31.02 | 8.99 | 39.11 | 47.91 | 54.00 | -6.09 | AV |

Remark:

1. Emission Level = Meter Reading + Antenna Factor + Cable Loss – Pre-amplifier,
Margin= Emission Level - Limit
2. If peak below the average limit, the average emission was no test.
3. The amplitude of spurious emissions which are attenuated by more than 20dB below the permissible value has no need to be reported.

π/4-DQPSK

| Polar (H/V) | Frequency | Meter Reading | Pre-amplifier | Cable Loss | Antenna Factor | Emission Level | Limits | Margin | Detector Type |
|---------------------|-----------|---------------|---------------|------------|----------------|----------------|----------|--------|---------------|
| | (MHz) | (dBuV) | (dB) | (dB) | (dB) | (dBuV/m) | (dBuV/m) | (dB) | |
| Low Channel:2402MHz | | | | | | | | | |
| V | 4804.00 | 49.58 | 30.55 | 5.77 | 31.12 | 55.92 | 74.00 | -18.08 | Pk |
| V | 4804.00 | 29.34 | 30.55 | 5.77 | 31.12 | 35.68 | 54.00 | -18.32 | AV |
| V | 7206.00 | 47.37 | 30.33 | 6.32 | 36.04 | 59.40 | 74.00 | -14.60 | Pk |
| V | 7206.00 | 30.29 | 30.33 | 6.32 | 36.04 | 42.32 | 54.00 | -11.68 | AV |
| V | 9608.00 | 47.37 | 30.85 | 7.45 | 37.58 | 61.55 | 74.00 | -12.45 | Pk |
| V | 9608.00 | 29.85 | 30.85 | 7.45 | 37.58 | 44.03 | 54.00 | -9.97 | AV |
| V | 12010.00 | 47.47 | 31.02 | 8.99 | 39.10 | 64.54 | 74.00 | -9.46 | Pk |
| V | 12010.00 | 29.75 | 31.02 | 8.99 | 39.10 | 46.82 | 54.00 | -7.18 | AV |
| H | 4804.00 | 49.92 | 30.55 | 5.77 | 31.12 | 56.26 | 74.00 | -17.74 | Pk |
| H | 4804.00 | 29.77 | 30.55 | 5.77 | 31.12 | 36.11 | 54.00 | -17.89 | AV |
| H | 7206.00 | 48.67 | 30.33 | 6.32 | 36.04 | 60.70 | 74.00 | -13.30 | Pk |
| H | 7206.00 | 29.98 | 30.33 | 6.32 | 36.04 | 42.01 | 54.00 | -11.99 | AV |
| H | 9608.00 | 48.69 | 30.85 | 7.45 | 37.58 | 62.87 | 74.00 | -11.13 | Pk |
| H | 9608.00 | 30.00 | 30.85 | 7.45 | 37.58 | 44.18 | 54.00 | -9.82 | AV |
| H | 12010.00 | 48.72 | 31.02 | 8.99 | 39.10 | 65.79 | 74.00 | -8.21 | Pk |
| H | 12010.00 | 29.01 | 31.02 | 8.99 | 39.10 | 46.08 | 54.00 | -7.92 | AV |

| Polar (H/V) | Frequency | Meter Reading | Pre-amplifier | Cable Loss | Antenna Factor | Emission Level | Limits | Margin | Detector Type |
|------------------------|-----------|---------------|---------------|------------|----------------|----------------|----------|--------|---------------|
| | (MHz) | (dBuV) | (dB) | (dB) | (dB) | (dBuV/m) | (dBuV/m) | (dB) | |
| Middle Channel:2441MHz | | | | | | | | | |
| V | 4882.00 | 49.80 | 30.55 | 5.77 | 31.46 | 56.48 | 74.00 | -17.52 | Pk |
| V | 4882.00 | 30.69 | 30.55 | 5.77 | 31.46 | 37.37 | 54.00 | -16.63 | AV |
| V | 7323.00 | 48.50 | 30.33 | 6.32 | 36.15 | 60.64 | 74.00 | -13.36 | Pk |
| V | 7323.00 | 30.52 | 30.33 | 6.32 | 36.15 | 42.66 | 54.00 | -11.34 | AV |
| V | 9764.00 | 48.58 | 30.85 | 7.45 | 37.76 | 62.94 | 74.00 | -11.06 | Pk |
| V | 9764.00 | 30.54 | 30.85 | 7.45 | 37.76 | 44.90 | 54.00 | -9.10 | AV |
| V | 12205.00 | 48.56 | 31.02 | 8.99 | 39.10 | 65.63 | 74.00 | -8.37 | Pk |
| V | 12205.00 | 30.55 | 31.02 | 8.99 | 39.10 | 47.62 | 54.00 | -6.38 | AV |
| H | 4882.00 | 51.06 | 30.55 | 5.77 | 31.46 | 57.74 | 74.00 | -16.26 | Pk |
| H | 4882.00 | 30.82 | 30.55 | 5.77 | 31.46 | 37.50 | 54.00 | -16.50 | AV |
| H | 7323.00 | 51.77 | 30.33 | 6.32 | 36.15 | 63.91 | 74.00 | -10.09 | Pk |
| H | 7323.00 | 30.62 | 30.33 | 6.32 | 36.15 | 42.76 | 54.00 | -11.24 | AV |
| H | 9764.00 | 51.97 | 30.85 | 7.45 | 37.76 | 66.33 | 74.00 | -7.67 | Pk |
| H | 9764.00 | 30.67 | 30.85 | 7.45 | 37.76 | 45.03 | 54.00 | -8.97 | AV |
| H | 12205.00 | 52.52 | 31.02 | 8.99 | 39.10 | 69.59 | 74.00 | -4.41 | Pk |
| H | 12205.00 | 30.60 | 31.02 | 8.99 | 39.10 | 47.67 | 54.00 | -6.33 | AV |

| Polar (H/V) | Frequency | Meter Reading | Pre-amplifier | Cable Loss | Antenna Factor | Emission Level | Limits | Margin | Detector Type |
|----------------------|-----------|---------------|---------------|------------|----------------|----------------|----------|--------|---------------|
| | (MHz) | (dBuV) | (dB) | (dB) | (dB) | (dBuV/m) | (dBuV/m) | (dB) | |
| High Channel:2480MHz | | | | | | | | | |
| V | 4960.00 | 49.50 | 30.55 | 5.77 | 31.79 | 56.51 | 74.00 | -17.49 | Pk |
| V | 4960.00 | 31.00 | 30.55 | 5.77 | 31.79 | 38.01 | 54.00 | -15.99 | AV |
| V | 7440.00 | 51.84 | 30.33 | 6.32 | 36.38 | 64.21 | 74.00 | -9.79 | Pk |
| V | 7440.00 | 31.29 | 30.33 | 6.32 | 36.38 | 43.66 | 54.00 | -10.34 | AV |
| V | 9920.00 | 51.84 | 30.85 | 7.45 | 36.50 | 64.94 | 74.00 | -9.06 | Pk |
| V | 9920.00 | 31.78 | 30.85 | 7.45 | 36.50 | 44.88 | 54.00 | -9.12 | AV |
| V | 12400.00 | 51.94 | 31.02 | 8.99 | 39.11 | 69.02 | 74.00 | -4.98 | Pk |
| V | 12400.00 | 30.98 | 31.02 | 8.99 | 39.11 | 48.06 | 54.00 | -5.94 | AV |
| H | 4960.00 | 49.52 | 30.55 | 5.77 | 31.79 | 56.53 | 74.00 | -17.47 | Pk |
| H | 4960.00 | 31.19 | 30.55 | 5.77 | 31.79 | 38.20 | 54.00 | -15.80 | AV |
| H | 7440.00 | 51.01 | 30.33 | 6.32 | 36.38 | 63.38 | 74.00 | -10.62 | Pk |
| H | 7440.00 | 31.47 | 30.33 | 6.32 | 36.38 | 43.84 | 54.00 | -10.16 | AV |
| H | 9920.00 | 51.70 | 30.85 | 7.45 | 36.50 | 64.80 | 74.00 | -9.20 | Pk |
| H | 9920.00 | 31.55 | 30.85 | 7.45 | 36.50 | 44.65 | 54.00 | -9.35 | AV |
| H | 12400.00 | 51.61 | 31.02 | 8.99 | 39.11 | 68.69 | 74.00 | -5.31 | Pk |
| H | 12400.00 | 30.53 | 31.02 | 8.99 | 39.11 | 47.61 | 54.00 | -6.39 | AV |

Remark:

1. Emission Level = Meter Reading + Antenna Factor + Cable Loss – Pre-amplifier,
Margin= Emission Level - Limit
2. If peak below the average limit, the average emission was no test.
3. The amplitude of spurious emissions which are attenuated by more than 20dB below the permissible value has no need to be reported.

8-DPSK

| Polar (H/V) | Frequency | Meter Reading | Pre-ampli fier | Cable Loss | Antenna Factor | Emission Level | Limits | Margin | Detector Type |
|---------------------|-----------|------------------|-------------------|---------------|-------------------|-------------------|----------|--------|------------------|
| | (MHz) | (dBuV) | (dB) | (dB) | (dB) | (dBuV/m) | (dBuV/m) | (dB) | |
| Low Channel:2402MHz | | | | | | | | | |
| V | 4804.00 | 50.80 | 30.55 | 5.77 | 31.12 | 57.14 | 74.00 | -16.86 | Pk |
| V | 4804.00 | 30.60 | 30.55 | 5.77 | 31.12 | 36.94 | 54.00 | -17.06 | AV |
| V | 7206.00 | 47.69 | 30.33 | 6.32 | 36.04 | 59.72 | 74.00 | -14.28 | Pk |
| V | 7206.00 | 31.60 | 30.33 | 6.32 | 36.04 | 43.63 | 54.00 | -10.37 | AV |
| V | 9608.00 | 48.89 | 30.85 | 7.45 | 37.58 | 63.07 | 74.00 | -10.93 | Pk |
| V | 9608.00 | 30.97 | 30.85 | 7.45 | 37.58 | 45.15 | 54.00 | -8.85 | AV |
| V | 12010.00 | 48.69 | 31.02 | 8.99 | 39.10 | 65.76 | 74.00 | -8.24 | Pk |
| V | 12010.00 | 31.04 | 31.02 | 8.99 | 39.10 | 48.11 | 54.00 | -5.89 | AV |
| H | 4804.00 | 50.95 | 30.55 | 5.77 | 31.12 | 57.29 | 74.00 | -16.71 | Pk |
| H | 4804.00 | 30.79 | 30.55 | 5.77 | 31.12 | 37.13 | 54.00 | -16.87 | AV |
| H | 7206.00 | 49.89 | 30.33 | 6.32 | 36.04 | 61.92 | 74.00 | -12.08 | Pk |
| H | 7206.00 | 31.10 | 30.33 | 6.32 | 36.04 | 43.13 | 54.00 | -10.87 | AV |
| H | 9608.00 | 49.81 | 30.85 | 7.45 | 37.58 | 63.99 | 74.00 | -10.01 | Pk |
| H | 9608.00 | 31.02 | 30.85 | 7.45 | 37.58 | 45.20 | 54.00 | -8.80 | AV |
| H | 12010.00 | 49.74 | 31.02 | 8.99 | 39.10 | 66.81 | 74.00 | -7.19 | Pk |
| H | 12010.00 | 30.13 | 31.02 | 8.99 | 39.10 | 47.20 | 54.00 | -6.80 | AV |

| Polar (H/V) | Frequency | Meter Reading | Pre-ampli fier | Cable Loss | Antenna Factor | Emission Level | Limits | Margin | Detector Type |
|------------------------|-----------|------------------|-------------------|---------------|-------------------|-------------------|----------|--------|------------------|
| | (MHz) | (dBuV) | (dB) | (dB) | (dB) | (dBuV/m) | (dBuV/m) | (dB) | |
| Middle Channel:2441MHz | | | | | | | | | |
| V | 4882.00 | 48.48 | 30.55 | 5.77 | 31.46 | 55.16 | 74.00 | -18.84 | Pk |
| V | 4882.00 | 29.37 | 30.55 | 5.77 | 31.46 | 36.05 | 54.00 | -17.95 | AV |
| V | 7323.00 | 46.34 | 30.33 | 6.32 | 36.15 | 58.48 | 74.00 | -15.52 | Pk |
| V | 7323.00 | 29.20 | 30.33 | 6.32 | 36.15 | 41.34 | 54.00 | -12.66 | AV |
| V | 9764.00 | 47.39 | 30.85 | 7.45 | 37.76 | 61.75 | 74.00 | -12.25 | Pk |
| V | 9764.00 | 29.47 | 30.85 | 7.45 | 37.76 | 43.83 | 54.00 | -10.17 | AV |
| V | 12205.00 | 47.29 | 31.02 | 8.99 | 39.10 | 64.36 | 74.00 | -9.64 | Pk |
| V | 12205.00 | 29.30 | 31.02 | 8.99 | 39.10 | 46.37 | 54.00 | -7.63 | AV |
| H | 4882.00 | 49.77 | 30.55 | 5.77 | 31.46 | 56.45 | 74.00 | -17.55 | Pk |
| H | 4882.00 | 29.50 | 30.55 | 5.77 | 31.46 | 36.18 | 54.00 | -17.82 | AV |
| H | 7323.00 | 51.10 | 30.33 | 6.32 | 36.15 | 63.24 | 74.00 | -10.76 | Pk |
| H | 7323.00 | 29.28 | 30.33 | 6.32 | 36.15 | 41.42 | 54.00 | -12.58 | AV |
| H | 9764.00 | 50.65 | 30.85 | 7.45 | 37.76 | 65.01 | 74.00 | -8.99 | Pk |
| H | 9764.00 | 29.98 | 30.85 | 7.45 | 37.76 | 44.34 | 54.00 | -9.66 | AV |
| H | 12205.00 | 48.48 | 31.02 | 8.99 | 39.10 | 65.55 | 74.00 | -8.45 | Pk |
| H | 12205.00 | 29.37 | 31.02 | 8.99 | 39.10 | 46.44 | 54.00 | -7.56 | AV |

| Polar (H/V) | Frequency | Meter Reading | Pre-ampli fier | Cable Loss | Antenna Factor | Emission Level | Limits | Margin | Detector Type |
|----------------------|-----------|------------------|-------------------|---------------|-------------------|-------------------|----------|--------|------------------|
| | (MHz) | (dBuV) | (dB) | (dB) | (dB) | (dBuV/m) | (dBuV/m) | (dB) | |
| High Channel:2480MHz | | | | | | | | | |
| V | 4960.00 | 48.91 | 30.55 | 5.77 | 31.79 | 55.92 | 74.00 | -18.08 | Pk |
| V | 4960.00 | 30.11 | 30.55 | 5.77 | 31.79 | 37.12 | 54.00 | -16.88 | AV |
| V | 7440.00 | 51.15 | 30.33 | 6.32 | 36.38 | 63.52 | 74.00 | -10.48 | Pk |
| V | 7440.00 | 30.83 | 30.33 | 6.32 | 36.38 | 43.20 | 54.00 | -10.80 | AV |
| V | 9920.00 | 51.25 | 30.85 | 7.45 | 36.50 | 64.35 | 74.00 | -9.65 | Pk |
| V | 9920.00 | 31.05 | 30.85 | 7.45 | 36.50 | 44.15 | 54.00 | -9.85 | AV |
| V | 12400.00 | 51.15 | 31.02 | 8.99 | 39.11 | 68.23 | 74.00 | -5.77 | Pk |
| V | 12400.00 | 30.39 | 31.02 | 8.99 | 39.11 | 47.47 | 54.00 | -6.53 | AV |
| H | 4960.00 | 48.93 | 30.55 | 5.77 | 31.79 | 55.94 | 74.00 | -18.06 | Pk |
| H | 4960.00 | 30.60 | 30.55 | 5.77 | 31.79 | 37.61 | 54.00 | -16.39 | AV |
| H | 7440.00 | 50.42 | 30.33 | 6.32 | 36.38 | 62.79 | 74.00 | -11.21 | Pk |
| H | 7440.00 | 31.06 | 30.33 | 6.32 | 36.38 | 43.43 | 54.00 | -10.57 | AV |
| H | 9920.00 | 51.12 | 30.85 | 7.45 | 36.50 | 64.22 | 74.00 | -9.78 | Pk |
| H | 9920.00 | 31.45 | 30.85 | 7.45 | 36.50 | 44.55 | 54.00 | -9.45 | AV |
| H | 12400.00 | 51.02 | 31.02 | 8.99 | 39.11 | 68.10 | 74.00 | -5.90 | Pk |
| H | 12400.00 | 30.96 | 31.02 | 8.99 | 39.11 | 48.04 | 54.00 | -5.96 | AV |

Remark:

1. Emission Level = Meter Reading + Antenna Factor + Cable Loss – Pre-amplifier,
Margin= Emission Level - Limit
2. If peak below the average limit, the average emission was no test.
3. The amplitude of spurious emissions which are attenuated by more than 20dB below the permissible value has no need to be reported.

5. BANDWIDTH OF FREQUENCY BAND EDGE

5.1 TEST REQUIREMENT:

| | | | | | |
|-----------------------|--|----------|------|------|---------|
| Test Requirement: | FCC Part15 C Section 15.209 and 15.205 | | | | |
| Test Method: | ANSI C63.10: 2013 | | | | |
| Test Frequency Range: | All of the restrict bands were tested, only the worst band's (2310MHz to 2500MHz) data was showed. | | | | |
| Test site: | Measurement Distance: 3m | | | | |
| Receiver setup: | Frequency | Detector | RBW | VBW | Value |
| | Above 1GHz | Peak | 1MHz | 3MHz | Peak |
| | | Average | 1MHz | 3MHz | Average |

Emissions radiated outside of the specified frequency bands, except for harmonics, shall be attenuated by at least 50 dB below the level of the fundamental or to the general radiated emission limits in § 15.209, whichever is the lesser attenuation

5.2 TEST PROCEDURE

Above 1GHz test procedure as below:

- a. 1. The EUT was placed on the top of a rotating table 1.5 meters above the ground at a 3 meter camber. The table was rotated 360 degrees to determine the position of the highest radiation.
- b. The EUT was set 3 meters away from the interference-receiving antenna, which was mounted on the top of a variable-height antenna tower.
- c. The antenna height is varied from one meter to four meters above the ground to determine the maximum value of the field strength. Both horizontal and vertical polarizations of the antenna are set to make the measurement.
- d. For each suspected emission, the EUT was arranged to its worst case and then the antenna was tuned to heights from 1 meter to 4 meters and the rota table was turned from 0 degrees to 360 degrees to find the maximum reading.
- e. The test-receiver system was set to Peak Detect Function and Specified Bandwidth with Maximum Hold Mode.
- f. If the emission level of the EUT in peak mode was 10dB lower than the limit specified, then testing could be stopped and the peak values of the EUT would be reported. Otherwise the emissions that did not have 10dB margin would be re-tested one by one using peak, quasi-peak or average method as specified and then reported in a data sheet.
- g. Test the EUT in the lowest channel, the Highest channel

Note:

Both horizontal and vertical antenna polarities were tested and performed pretest to three orthogonal axis. The worst case emissions were reported

5.3 DEVIATION FROM TEST STANDARD

No deviation

5.4 TEST SETUP

Radiated Emission Test-Up Frequency Above 1GHz

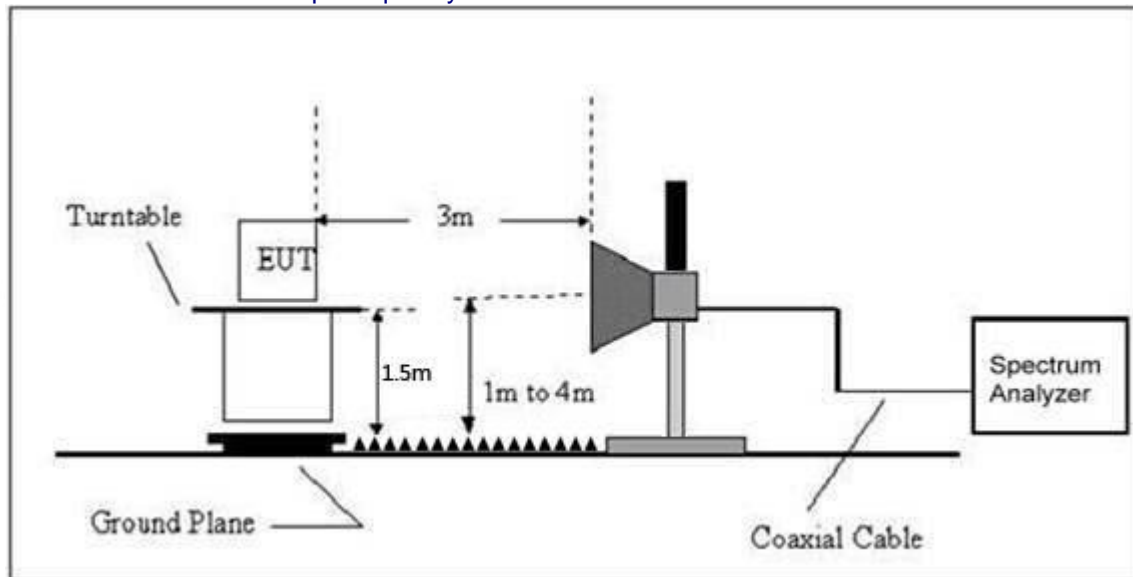

5.5 EUT OPERATING CONDITIONS

The EUT tested system was configured as the statements of 2.3 Unless otherwise a special operating condition is specified in the follows during the testing.

5.6 TEST RESULT

| | | | |
|---------------|-------------------------|---------------------|-------------|
| Temperature : | 26 °C | Relative Humidity : | 54% |
| Pressure : | 101 kPa | Test Voltage : | AC120V/60Hz |
| Test Mode : | TX Mode-GFSK-Worst Case | | |

Peak value:

| Frequency (MHz) | Read Level (dBuV) | Antenna Factor (dB/m) | Cable Loss (dB) | Preamp Factor (dB) | Level (dBuV/m) | Limit Line (dBuV/m) | Over Limit (dB) | Polarization |
|-----------------|-------------------|-----------------------|-----------------|--------------------|----------------|---------------------|-----------------|--------------|
| 2390.00 | 45.17 | 27.25 | 5.38 | 30.18 | 47.62 | 74.00 | -26.38 | Horizontal |
| 2400.00 | 47.25 | 27.26 | 5.39 | 30.18 | 49.72 | 74.00 | -24.28 | Horizontal |
| 2390.00 | 45.10 | 27.25 | 5.38 | 30.18 | 47.55 | 74.00 | -26.45 | Vertical |
| 2400.00 | 44.69 | 27.26 | 5.39 | 30.18 | 47.16 | 74.00 | -26.84 | Vertical |

2402MHz Horizontal

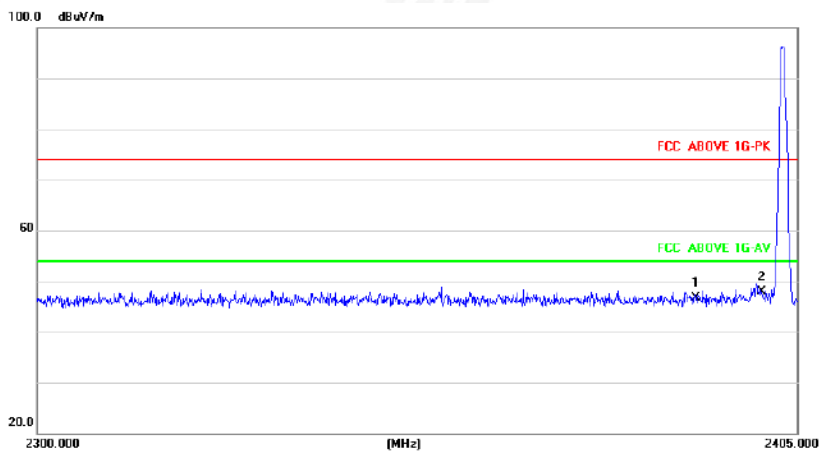

2402MHz Vertical

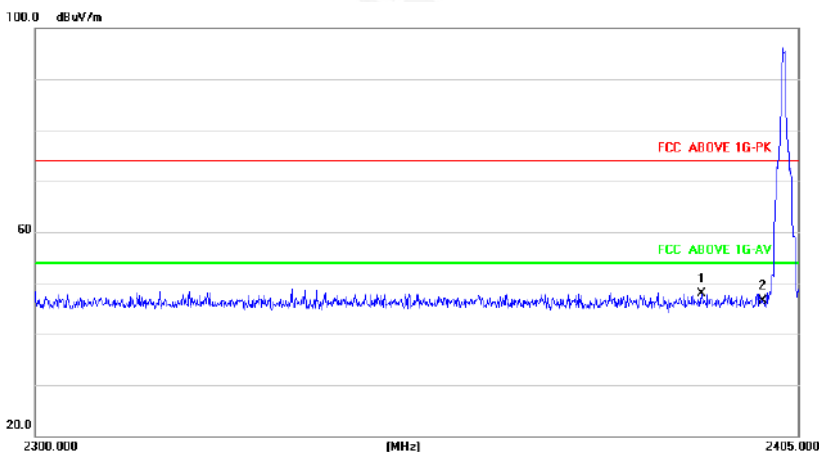

| | | | |
|---------------|-------------------------|---------------------|-------------|
| Temperature : | 26 °C | Relative Humidity : | 54% |
| Pressure : | 101 kPa | Test Voltage : | AC120V/60Hz |
| Test Mode : | TX Mode-GFSK-Worst Case | | |

Peak value:

| Frequency (MHz) | Read Level (dBuV) | Antenna Factor (dB/m) | Cable Loss (dB) | Preamp Factor (dB) | Level (dBuV/m) | Limit Line (dBuV/m) | Over Limit (dB) | Polarization |
|-----------------|-------------------|-----------------------|-----------------|--------------------|----------------|---------------------|-----------------|--------------|
| 2483.50 | 45.48 | 27.25 | 5.47 | 29.93 | 48.27 | 74.00 | -25.73 | Horizontal |
| 2500.00 | 46.51 | 27.26 | 5.49 | 29.93 | 49.33 | 74.00 | -24.67 | Horizontal |
| 2483.50 | 46.74 | 27.25 | 5.47 | 29.93 | 49.53 | 74.00 | -24.47 | Vertical |
| 2500.00 | 47.66 | 27.26 | 5.49 | 29.93 | 50.48 | 74.00 | -23.52 | Vertical |

2480MHz Horizontal

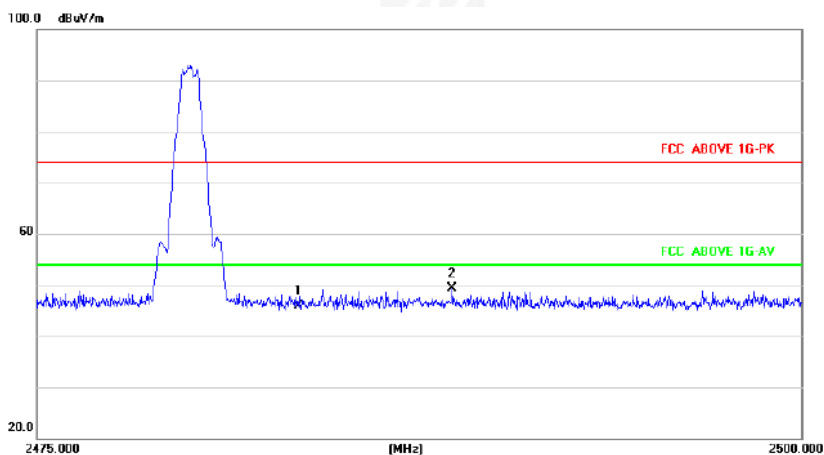

2480MHz Vertical

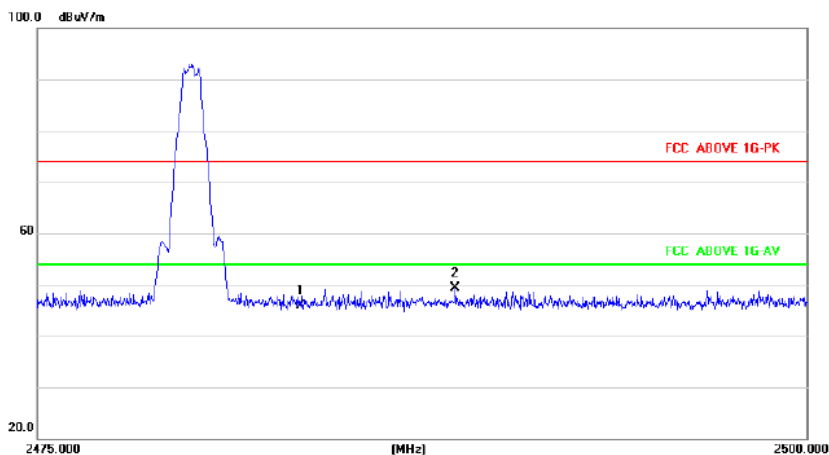

6. CHANNEL BANDWIDTH

| | |
|-------------------|------------------------------------|
| Test Requirement: | FCC Part15 C Section 15.249/15.215 |
| Test Method: | ANSI C63.10: 2013 |

6.1 APPLIED PROCEDURES / LIMIT

| FCC Part15 (15.249) , Subpart C | | | |
|---------------------------------|-----------|-----------------------|--------|
| Section | Test Item | Frequency Range (MHz) | Result |
| 15.249(c) | Bandwidth | 2400-2483.5 | PASS |

6.2 TEST PROCEDURE

1. Set resolution bandwidth (RBW) = 1-5% or DTS BW, not to exceed 100 kHz.
2. Set the video bandwidth (VBW) $\geq 3 \times$ RBW.
3. Detector = Peak.
4. Trace mode = max hold.
5. Sweep = auto couple.
6. Allow the trace to stabilize.
7. Measure the maximum width of the emission that is constrained by the frequencies associated with the two outermost amplitude points (upper and lower) that are attenuated by 6 dB relative to the maximum level measured in the fundamental emission.

6.3 DEVIATION FROM STANDARD

No deviation.

6.4 TEST SETUP

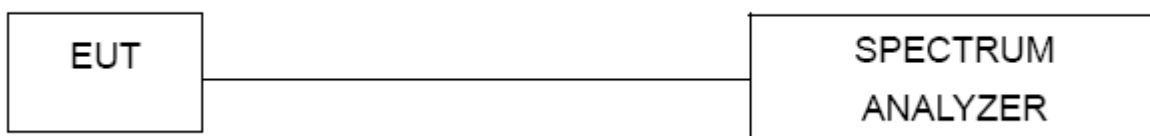

6.5 EUT OPERATION CONDITIONS

The EUT tested system was configured as the statements of 2.4 Unless otherwise a special operating condition is specified in the follows during the testing.

6.6 TSET RESULTS

| | | | |
|---------------|------|---------------------|-------------|
| Temperature : | 26°C | Relative Humidity : | 54% |
| Test Mode : | GFSK | Test Voltage : | AC120V/60Hz |

| Mode | Test channel | 20dB Emission Bandwidth (MHz) | Result |
|----------------|--------------|-------------------------------|--------|
| GFSK | Lowest | 0.974 | Pass |
| | Middle | 0.970 | |
| | Highest | 0.982 | |
| $\pi/4$ -DQPSK | Lowest | 1.344 | Pass |
| | Middle | 1.351 | |
| | Highest | 1.348 | |
| 8-DPSK | Lowest | 1.328 | Pass |
| | Middle | 1.331 | |
| | Highest | 1.323 | |

Test plots

GFSK

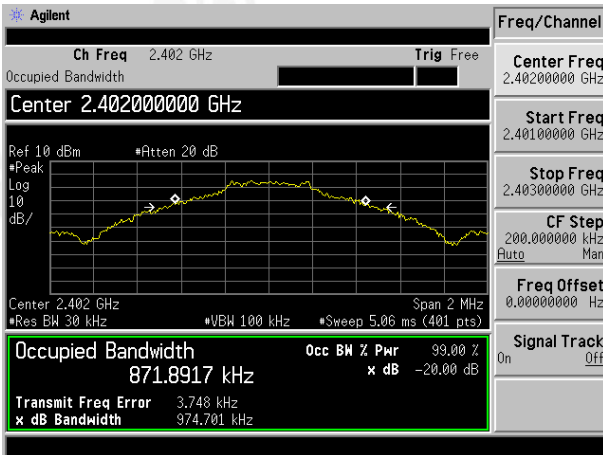

$\pi/4$ -DQPSK

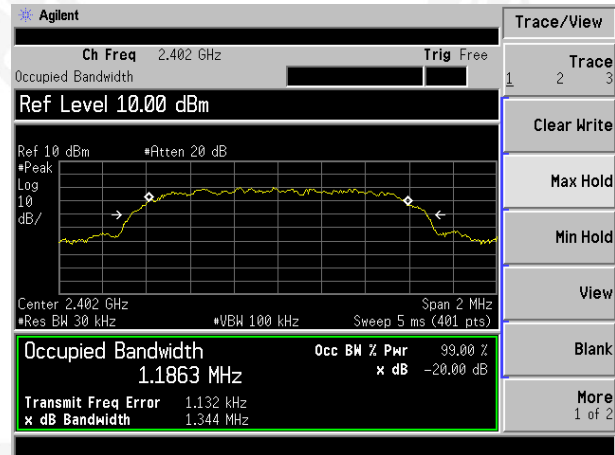

Lowest channel

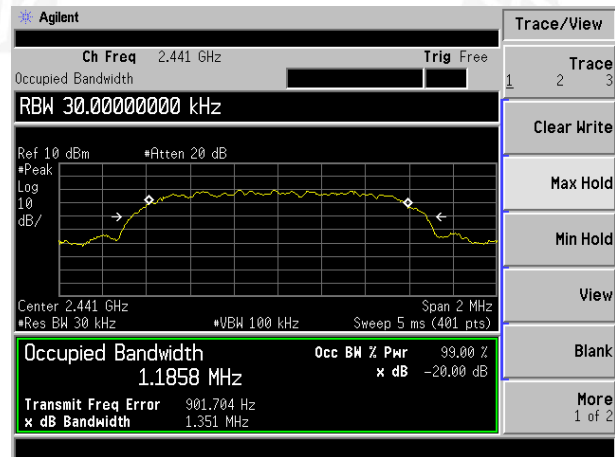
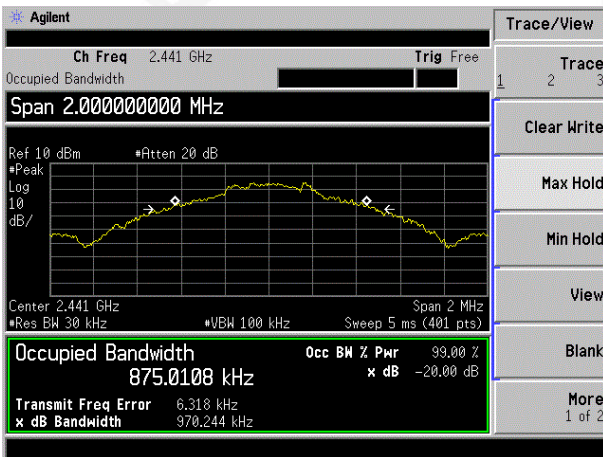

Middle channel

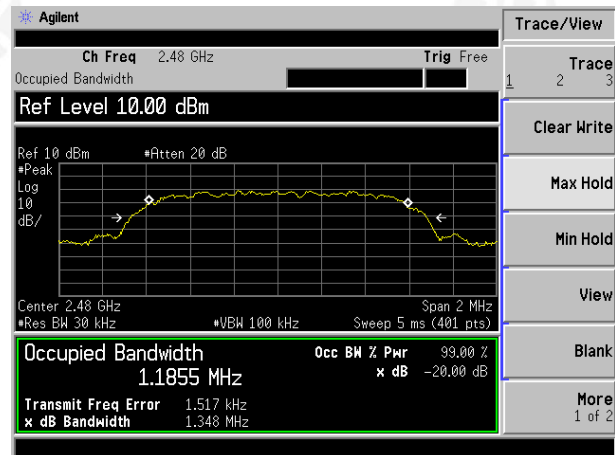
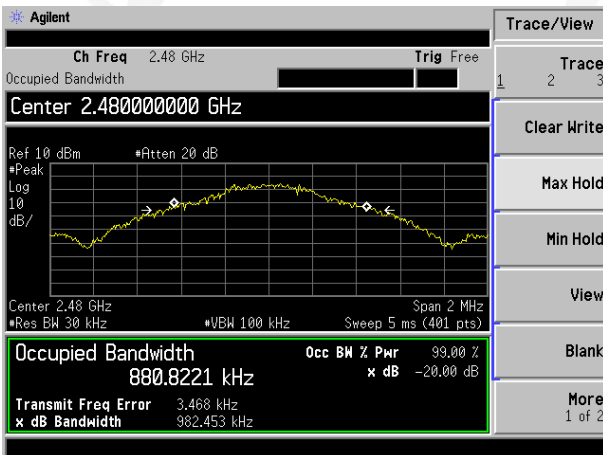

Highest channel

8-DPSK

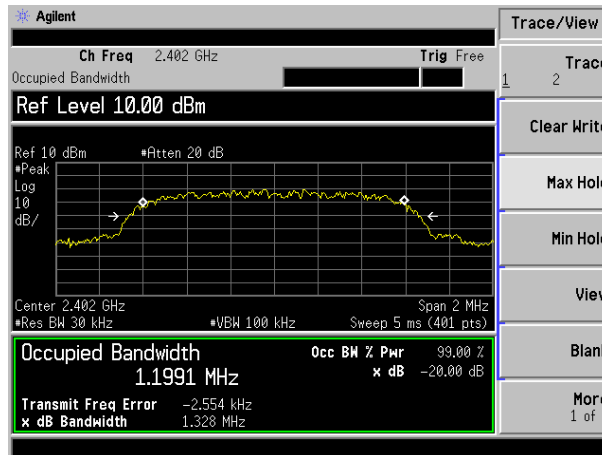

Lowest channel

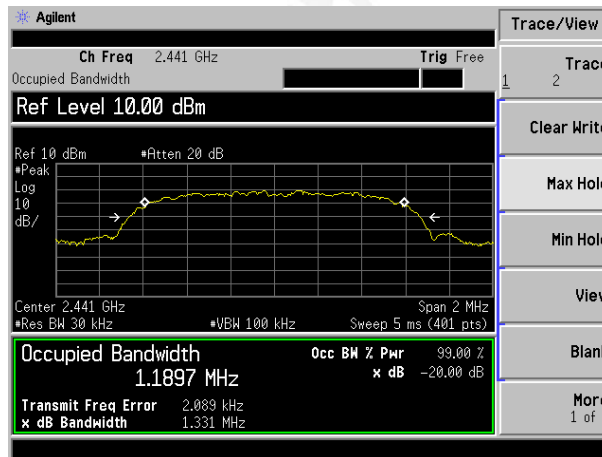

Middle channel

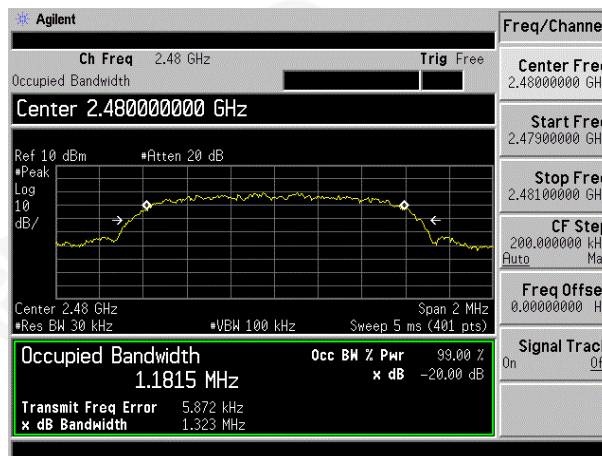

Highest channel

8.ANTENNA REQUIREMENT

| | |
|---|-----------------------------|
| Standard requirement: | FCC Part15 C Section 15.203 |
| 15.203 requirement: An intentional radiator shall be designed to ensure that no antenna other than that furnished by the responsible party shall be used with the device. The use of a permanently attached antenna or of an antenna that uses a unique coupling to the intentional radiator, the manufacturer may design the unit so that a broken antenna can be replaced by the user, but the use of a standard antenna jack or electrical connector is prohibited. | |
| EUT Antenna: | |
| The antennas are PCB antenna, the best case gain of the antennas are 0dBi, reference to the appendix II for details | |

9. TEST SETUP PHOTO

Reference to the appendix I for details.

10. EUT CONSTRUCTIONAL DETAILS

Reference to the appendix II for details.

***** END OF REPORT *****