



# TEST REPORT

## FCC ID: 2A48S-E61B

Applicant: Shenzhenshi Weiduli Technology Co.,Ltd.  
Address: 4h Floor, Building 4, Dejin Industrial Zone, No. 40, Fuyuan 1st Road, Heping Community, Fuhai Street, Bao'an District, Shenzhen  
Manufacturer: Shenzhenshi Weiduli Technology Co.,Ltd.  
Address: 4h Floor, Building 4, Dejin Industrial Zone, No. 40, Fuyuan 1st Road, Heping Community, Fuhai Street, Bao'an District, Shenzhen  
EUT: power bank  
Trade Mark: N/A  
Model Number: E61B  
E61, E61A, E61C, E61D, E61E  
Date of Receipt: Mar. 01, 2024  
Test Date: Mar. 01, 2024 - Mar. 14, 2024  
Date of Report: Mar. 14, 2024  
Prepared By: Shenzhen DL Testing Technology Co., Ltd.  
Address: 101-201, Building C, Shuanghuan, No.8, Baoqing Road, Baolong Industrial Zone, Baolong Street, Longgang District, Shenzhen, Guangdong, China  
Applicable Standards: FCC PART 15 Subpart C  
ANSI C63.10:2013  
Test Result: Pass  
Report Number: DL-20240301054E

Prepared (Engineer): Alisa Song

Reviewer (Supervisor): Jack Bu

Approved (Manager): Jade Yang



*This test report is based on a single evaluation of one sample of above mentioned products. It is not permitted to be duplicated in extracts without written approval of Shenzhen DL Testing Technology Co., Ltd.*



**TABLE OF CONTENT**

	Page
Test Report Declaration	
<b>1. VERSION .....</b>	<b>3</b>
<b>2. TEST SUMMARY .....</b>	<b>3</b>
<b>3. GENERAL INFORMATION .....</b>	<b>4</b>
<b>4. TEST INSTRUMENT USED.....</b>	<b>6</b>
<b>5. CONDUCTED EMISSION TEST.....</b>	<b>7</b>
<b>6. RADIATION EMISSION TEST.....</b>	<b>11</b>
<b>7. BANDWIDTH TEST .....</b>	<b>19</b>
<b>8. SETUP PHOTOGRAPHS .....</b>	<b>20</b>
<b>9. EUT PHOTOGRAPHS .....</b>	<b>20</b>

**1. VERSION**

Version No.	Date	Description
00	Mar. 14, 2024	Original

**2. TEST SUMMARY**

EMC Emission			
Test Item	Section in CFR 47	Result	Remark
AC Power Line Conducted Emission	15.207	PASS	
Spurious Emission	15.209(a)(f)	PASS	
20dB Bandwidth	15.215	PASS	
Antenna requirement	15.203	PASS	

**NOTE:**

(1)" N/A" denotes test is not applicable in this Test Report

Test lab: Shenzhen DL Testing Technology Co., Ltd.

Address: 101-201, Building C, Shuanghuan, No.8, Baoqing Road, Baolong Industrial Zone, Baolong Street, Longgang District, Shenzhen, Guangdong, China

FCC Test Firm Registration Number: 854456

Designation Number: CN1307

IC Registered No.: 27485

CAB ID.: CN0118



### 3. GENERAL INFORMATION

#### 3.1 Description of Device (EUT)

Product Name: power bank  
Trade Mark: N/A  
Model No.: E61B  
E61, E61A, E61C, E61D, E61E  
Model Difference: The product's different for model number and appearance color.  
Serial No.: N/A  
Hardware version: H1.0  
Software version: S1.0  
Operation Frequency: 115kHz ~ 205KHz  
Modulation type: MSK  
Antenna Type: Inductive loop coil Antenna  
Antenna gain: 0dBi  
Power supply: IN(TYPE-C1): 5V/3A, 9V/2A  
OUT(TYPE-C1): 5V/3A, 9V/2.22A, 12V/1.67A  
IN(TYPE-C2): 5V/2A, 9V2A  
OUT/Wireless charger: 5W/7.5W/10W/15W  
Battery capacity: 10000mAh/3.85V/38.5Wh

#### 3.2 Tested System Details

None.

#### 3.3 Block Diagram of Test Set-up

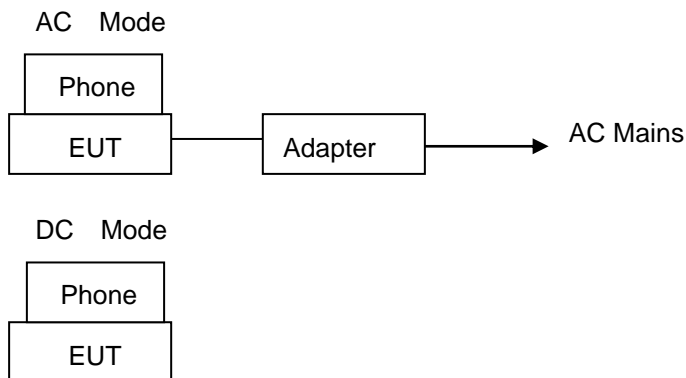



### 3.4 Test Mode Description

- Mode1. Type-C Input+Wireless charger Output Mode(Full Load, 1%/50%/99%)
- Mode2. Type-C Input+Wireless charger Output Mode(Half Load, 1%/50%/99%)
- Mode3. Type-C Input+Wireless charger Output Mode(No Load, 1%/50%/99%)
- Mode4. Wireless charger Output Mode(Full Load, 1%/50%/99%)
- Mode5. Wireless charger Output Mode(Half Load, 1%/50%/99%)
- Mode6. Wireless charger Output Mode(No Load, 1%/50%/99%)

Note: 1. We have evaluated 1%, 50% and 99% battery charging mode, and the worst mode (99%) is showed in this report.

2. All modes have been tested, and the report only shows the results of the worst mode1 and mode4.

### 3.5 Test Auxiliary Equipment

Adapter (Provide by test lab):

Manufacturer: XIAOMI

Model: AD65G

I/P: AC 100-240V 50/60Hz

O/P: DC 5V/3A, DC 9V/3A, DC 10V/5A, DC 12V/3A,

DC 15V/3A, DC 20V/3.25A

Mobile phone (Provide by test lab):

Manufacturer: SAMSUNG

Model: Galaxy S21 5G

### 3.6 Test Uncertainty

Conducted Emission Uncertainty(150KHz-30MHz)	:	±2.56dB
20dB Bandwidth	:	±0.5kHz
Radiated Emission Uncertainty(9KHz-1GHz)	:	±3.24dB

**4. TEST INSTRUMENT USED****For Conducted Emission Test (843 Shielded Room)**

Equipment	Manufacturer	Model	Serial	Last Cal.	Next Cal.
843 Shielded Room	ChengYu	843 Room	843	Sep. 20, 2022	Sep. 19, 2025
EMI Receiver	R&S	ESR	101421	Nov. 04, 2023	Nov. 03, 2024
LISN	R&S	ENV216	102417	Nov. 04, 2023	Nov. 03, 2024
Clamp	COM-POWER	CLA-050	431071	Nov. 04, 2023	Nov. 03, 2024
3-Loop Antenna	DAZE	ZN30401	13021	Nov. 04, 2023	Nov. 03, 2024
ISN T8	Schwarzbeck	NTFM 8158	101135	Nov. 04, 2023	Nov. 03, 2024
ISN T5	Schwarzbeck	NTFM 8158	101136	Nov. 04, 2023	Nov. 03, 2024
843 Cable 1#	ChengYu	CE Cable	001	Nov. 04, 2023	Nov. 03, 2024
843 Cable 1#	ChengYu	CE Cable	002	Nov. 04, 2023	Nov. 03, 2024

**For Radiated Emission Test (966 chamber)**

Equipment	Manufacturer	Model	Serial	Last Cal.	Next Cal.
966 Chamber	ChengYu	966 Room	966	Sep. 20, 2022	Sep. 19, 2025
Spectrum Analyzer	Agilent	E4408B	MY50140780	Nov. 04, 2023	Nov. 03, 2024
EMI Receiver	R&S	ESRP7	101393	Nov. 04, 2023	Nov. 03, 2024
Amplifier	Schwarzbeck	BBV9743B	00153	Nov. 04, 2023	Nov. 03, 2024
Amplifier	EMEC	EM01G8GA	00270	Nov. 04, 2023	Nov. 03, 2024
Broadband Trilog Antenna	Schwarzbeck	VULB9162	00306	Nov. 04, 2023	Nov. 03, 2024
Horn Antenna	Schwarzbeck	BBHA9120D	02139	Nov. 04, 2023	Nov. 03, 2024
Loop Antenna	ZHINAN	ZN30900A	/	Nov. 04, 2023	Nov. 03, 2024
966 Cable 1#	ChengYu	966	004	Nov. 04, 2023	Nov. 03, 2024
966 Cable 2#	ChengYu	966	003	Nov. 04, 2023	Nov. 03, 2024

**5. CONDUCTED EMISSION TEST**

5.1 Block Diagram of Test Setup

**For Mains Terminals Test**

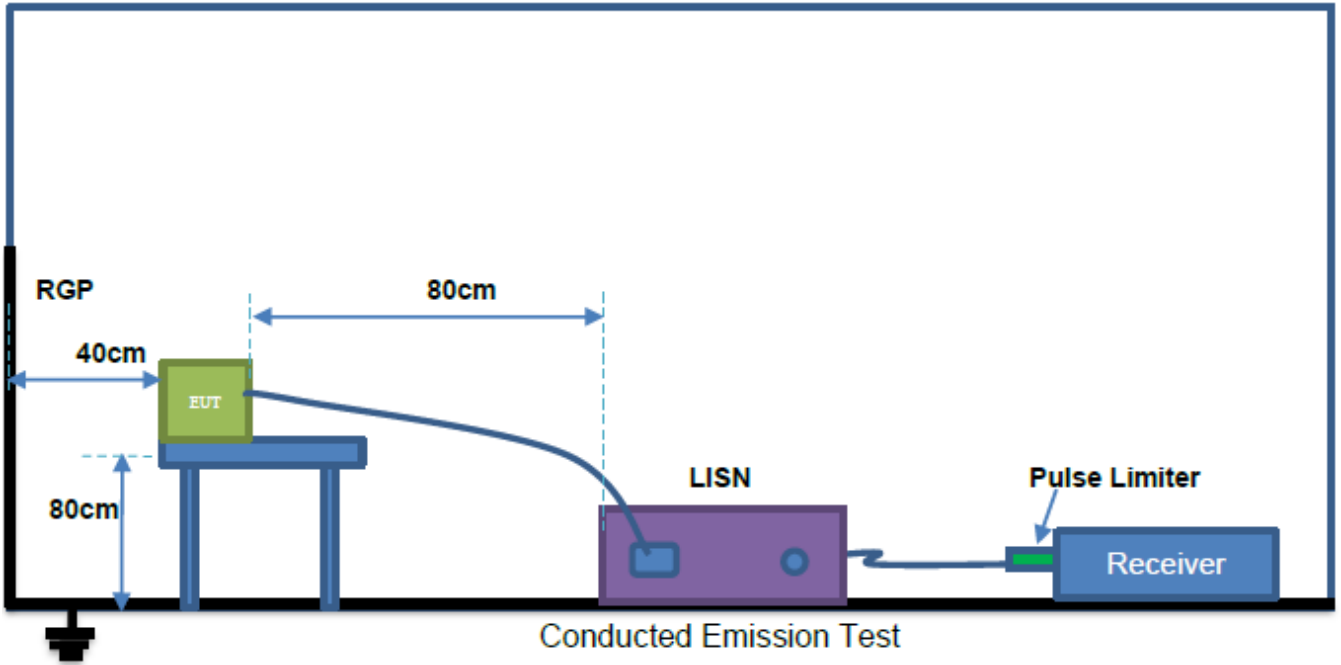

5.2 Test Standard and Limit

FCC Part 15 Subpart C

Frequency MHz	Limits dB(μV)	
	Quasi-peak Level	Average Level
0.15~0.50	66 ~ 56*	55 ~ 46*
0.50~5.00	56	46
5.00~30.00	60	50

Notes: 1. \*Decreasing linearly with logarithm of frequency.

2. The lower limit shall apply at the transition frequencies.

5.3 EUT Configuration on Test

The following equipment's are installed on conducted emission test to meet FCC Part 15 Subpart C requirement and operating in a manner which tends to maximize its emission characteristics in a normal application.

5.4 Operating Condition of EUT

5.4.1 Setup the EUT and simulators as shown in Section 5.1.

5.4.2 Turn on the power of all equipments.

5.4.3 Let the EUT work in test modes and test it.



### 5.5 Test Procedure

The EUT is put on the table and connected to the AC mains through a Artificial Mains Network (AMN) or ISN. This provided a 50ohm coupling impedance for the tested equipments. Both sides of AC line are checked to find out the maximum conducted emission levels according to the **ANSI C63.10** regulations during conducted emission test.

The bandwidth of the test receiver (R&S Test Receiver ESR) is set at 10KHz.

The frequency range from 150 KHz to 30 MHz is investigated.

Notes:

- 1.An initial pre-scan was performed on the line and neutral lines with peak detector.
- 2.Quasi-Peak and Average measurement were performed at the frequencies with maximized peak emission.
- 3.Mesurement Level = Reading level + Correct Factor

### 5.6 Test Result

PASS

Please refer to the following page.





Conducted Emission Test Data			
Temperature:	24.5 °C	Relative Humidity:	54%
Pressure:	1009hPa	Phase:	Line
Test Voltage:	AC 120V/60Hz	Test Mode:	Mode 1(99%, Mobile)

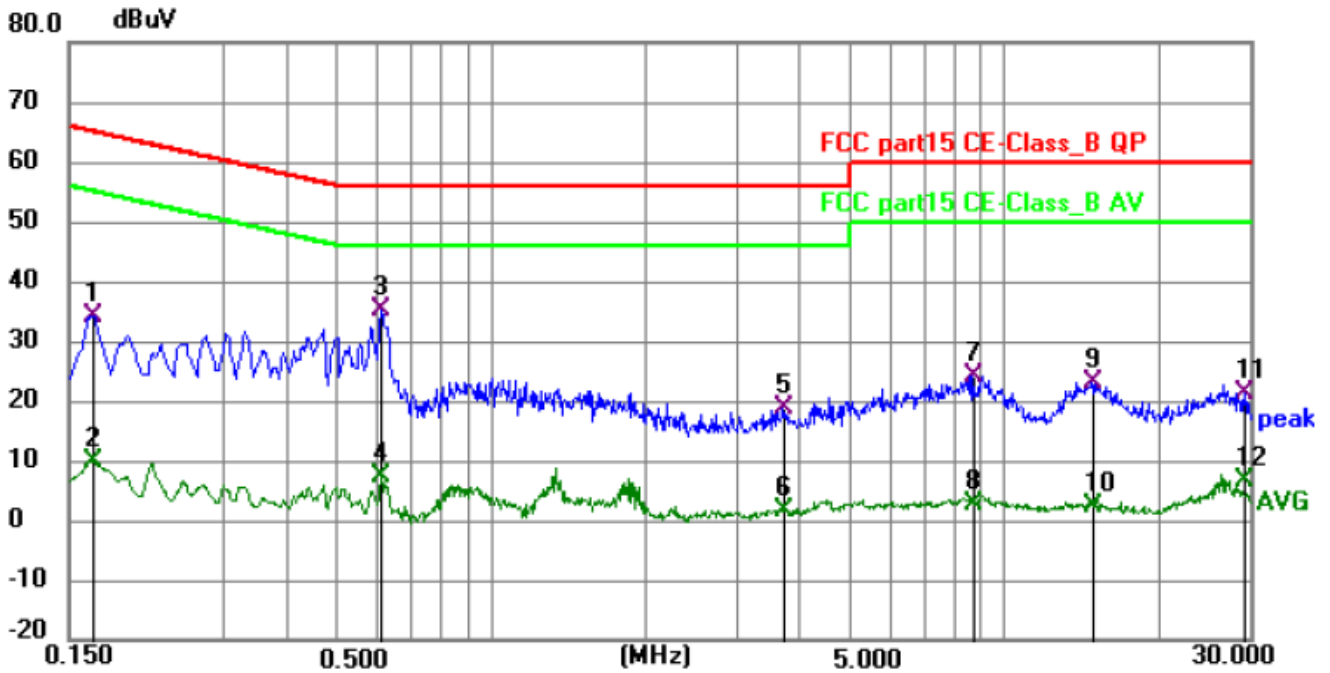

No.	Frequency (MHz)	Reading (dBuV)	Factor (dB)	Level (dBuV)	Limit (dBuV)	Margin (dB)	Detector	P/F	Remark
1	0.1680	24.29	9.86	34.15	65.06	-30.91	QP	P	
2	0.1680	0.04	9.86	9.90	55.06	-45.16	AVG	P	
3 *	0.6090	25.98	9.31	35.29	56.00	-20.71	QP	P	
4	0.6090	-2.15	9.31	7.16	46.00	-38.84	AVG	P	
5	3.7275	8.66	10.01	18.67	56.00	-37.33	QP	P	
6	3.7275	-8.45	10.01	1.56	46.00	-44.44	AVG	P	
7	8.7090	13.85	10.22	24.07	60.00	-35.93	QP	P	
8	8.7090	-7.50	10.22	2.72	50.00	-47.28	AVG	P	
9	14.8515	12.66	10.38	23.04	60.00	-36.96	QP	P	
10	14.8515	-7.90	10.38	2.48	50.00	-47.52	AVG	P	
11	29.3730	10.06	11.03	21.09	60.00	-38.91	QP	P	
12	29.3730	-4.26	11.03	6.77	50.00	-43.23	AVG	P	



Conducted Emission Test Data			
Temperature:	24.5 °C	Relative Humidity:	54%
Pressure:	1009hPa	Phase:	Neutral
Test Voltage:	AC 120V/60Hz	Test Mode:	Mode 1(99%, Mobile)

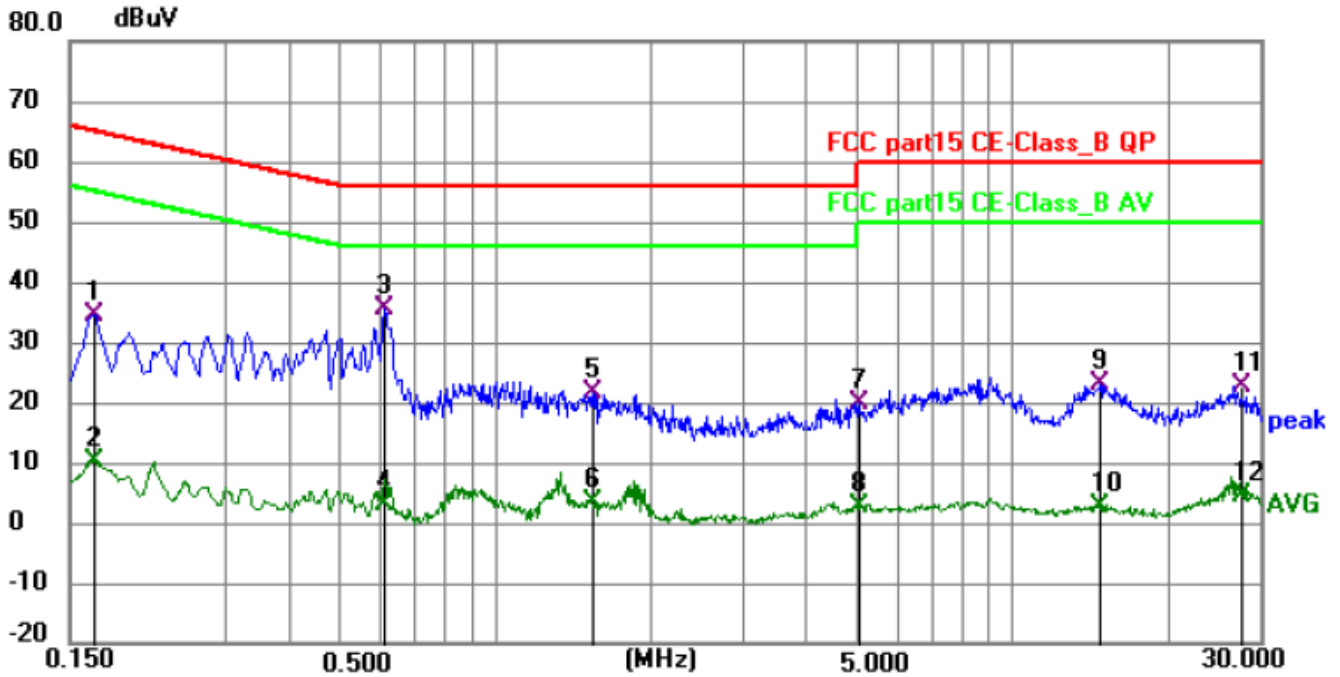

No.	Frequency (MHz)	Reading (dBuV)	Factor (dB)	Level (dBuV)	Limit (dBuV)	Margin (dB)	Detector	P/F	Remark
1	0.1680	24.29	10.18	34.47	65.06	-30.59	QP	P	
2	0.1680	0.04	10.18	10.22	55.06	-44.84	AVG	P	
3 *	0.6090	25.98	9.40	35.38	56.00	-20.62	QP	P	
4	0.6090	-6.19	9.40	3.21	46.00	-42.79	AVG	P	
5	1.5405	11.90	9.67	21.57	56.00	-34.43	QP	P	
6	1.5405	-6.20	9.67	3.47	46.00	-42.53	AVG	P	
7	5.0324	9.79	9.95	19.74	60.00	-40.26	QP	P	
8	5.0324	-7.27	9.95	2.68	50.00	-47.32	AVG	P	
9	14.8020	12.66	10.23	22.89	60.00	-37.11	QP	P	
10	14.8020	-7.72	10.23	2.51	50.00	-47.49	AVG	P	
11	27.6675	11.40	11.11	22.51	60.00	-37.49	QP	P	
12	27.6675	-6.79	11.11	4.32	50.00	-45.68	AVG	P	

### 6. RADIATION EMISSION TEST

#### 6.1 Block Diagram of Test Setup

Radiated Emission Test-Up Frequency Below 30MHz

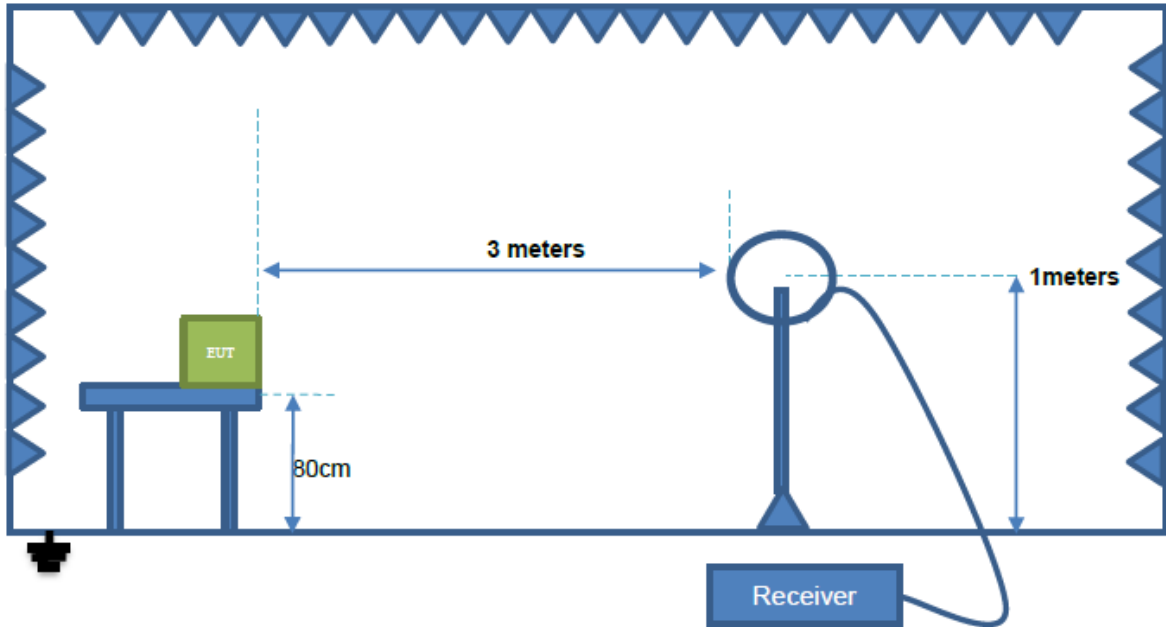

Radiation Test (9k - 30MHz)

Below 1GHz

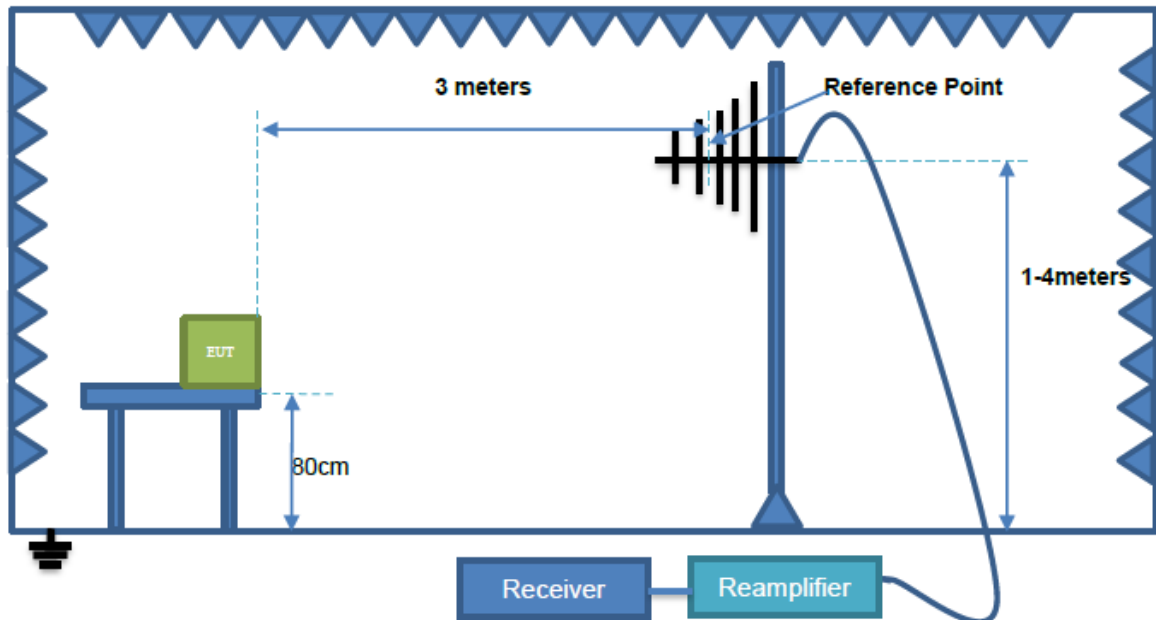

Radiation Test (30MHz – 1GHz)

#### 6.2 Test Standard and Limit

FCC Part 15 Subpart C



Limits for frequency below 30MHz

Frequency	Limit (uV/m)	Measurement Distance(m)	Remark
0.009-0.090	2400/F(kHz)	300	AVERAGE
0.090-0.110	2400/F(kHz)	300	Quasi-peak Value
0.110-0.490	2400/F(kHz)	300	AVERAGE
0.490-1.705	24000/F(kHz)	30	Quasi-peak Value
1.705-30	30	30	Quasi-peak Value

Above 30MHz

Frequency (MHz)	Distance (Meters)	Field Strengths Limits (dBµV/m)	Remark
30 ~ 88	3	40.0	Quasi-peak Value
88 ~ 216	3	43.5	Quasi-peak Value
216 ~ 960	3	46.0	Quasi-peak Value
960 ~ 1000	3	54.0	Quasi-peak Value
Above 1000	3	74.0	PEAK
		54.0	AVERAGE

Remark:

(1) The smaller limit shall apply at the cross point between two frequency bands.

(2) Distance refers to the distance in meters between the measuring instrument, antenna and the closed point of any part of the device or system.

6.3 EUT Configuration on Test

The FCC Part 15 Subpart C regulations test method must be used to find the maximum emission during radiated emission test.

The configuration of EUT is the same as used in conducted emission test.

Please refer to Section 5.3.

6.4 Operating Condition of EUT

Same as conducted emission test, which is listed in Section 5.4 except the test set up replaced as Section 6.2.

6.5 Test Procedure

1) The radiated emissions test was conducted in a semi-anechoic chamber.

2) The tabletop EUT was placed upon a non-metallic table 0.8m above the ground reference plane. And for floor-standing arrangement, the EUT was placed on the horizontal ground reference plane, but separated from metallic contact with the ground reference plane by 0.1m of insulation.

3) Before final measurements of radiated emissions, a pre-scan was performed in the spectrum mode with the peak detector to find out the maximum emissions spectrum plots of the EUT.

4) The frequencies of maximum emission were determined in the final radiated emissions measurement. At each frequency, the EUT was rotated 360°, and the antenna was raised and lowered from 1 to 4 meters in order to determine the maximum disturbance. Measurements were performed for both horizontal and vertical antenna polarization.

5) The bandwidth setting on the field strength meter (R&S Test Receiver ESCI) is set at 120KHz.

6) The frequency range from 30MHz to 1000MHz is checked.



6.6 Test Result

PASS, Please refer to the following page.

Radiation Emission Test Data 9 kHz~30 MHz			
Temperature:	24.5 °C	Relative Humidity:	54%
Pressure:	1009hPa	Polarization:	/
Test Voltage:	AC 120V/60Hz	Test Mode:	Mode 1(Mobile)

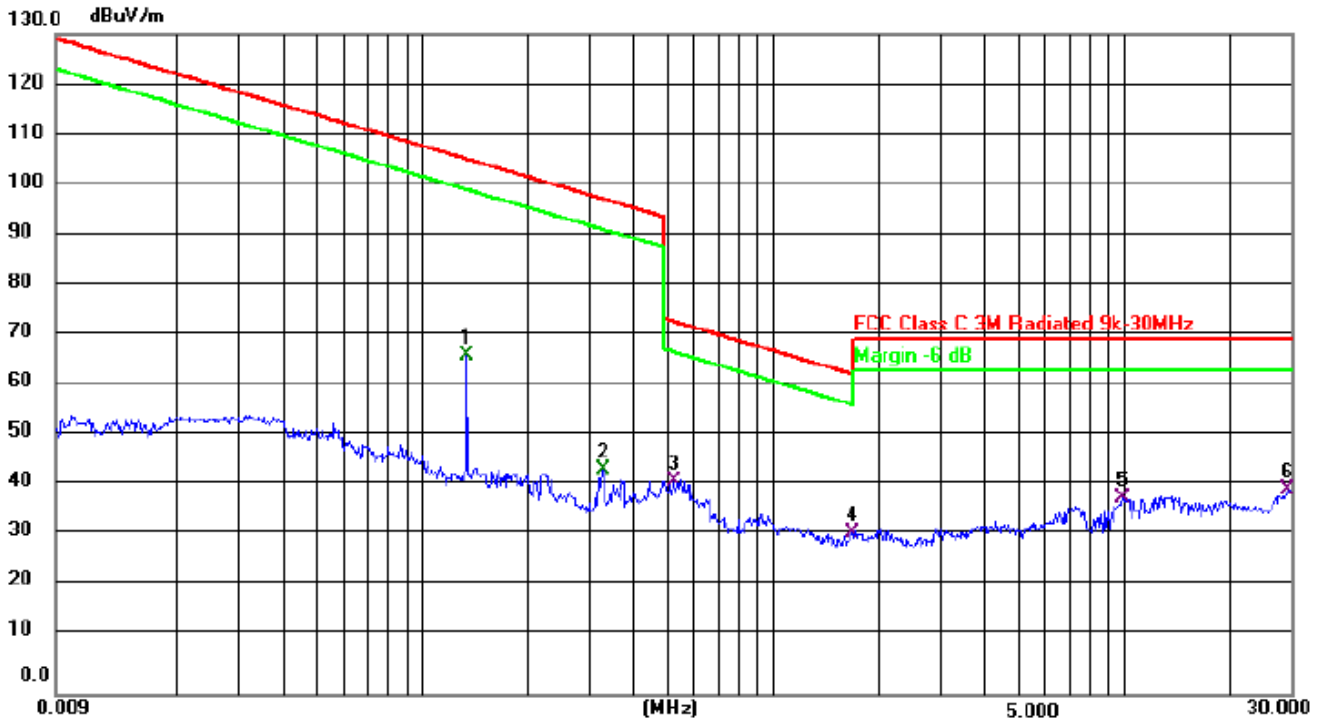

Frequency (MHz)	Meter Reading (dBμV)	Factor (dB)	Emission Level (dBμV/m)	Limits (dBμV/m)	Margin (dB)	Detector Type
0.1340	66.92	10.22	77.14	105.35	-28.21	Peak
0.3271	42.24	10.47	52.71	97.54	-44.83	Peak
0.5191	41.09	10.88	51.97	73.49	-21.52	Peak
1.6846	29.93	10.23	40.16	63.11	-22.95	Peak
9.8734	36.06	10.18	46.24	70	-23.76	Peak
29.0422	38.58	10.69	49.27	70	-20.73	Peak

Note:

Pre-scan in the all of mode, the worst case in of was recorded.

Factor = antenna factor + cable loss – pre-amplifier.

Margin = Emission Level(Meter Reading+ Factor) - Limit.



Radiation Emission Test Data 9 kHz~30 MHz			
Temperature:	24.5 °C	Relative Humidity:	54%
Pressure:	1009hPa	Polarization:	/
Test Voltage:	DC 3.85V	Test Mode:	Mode 4(Portable)

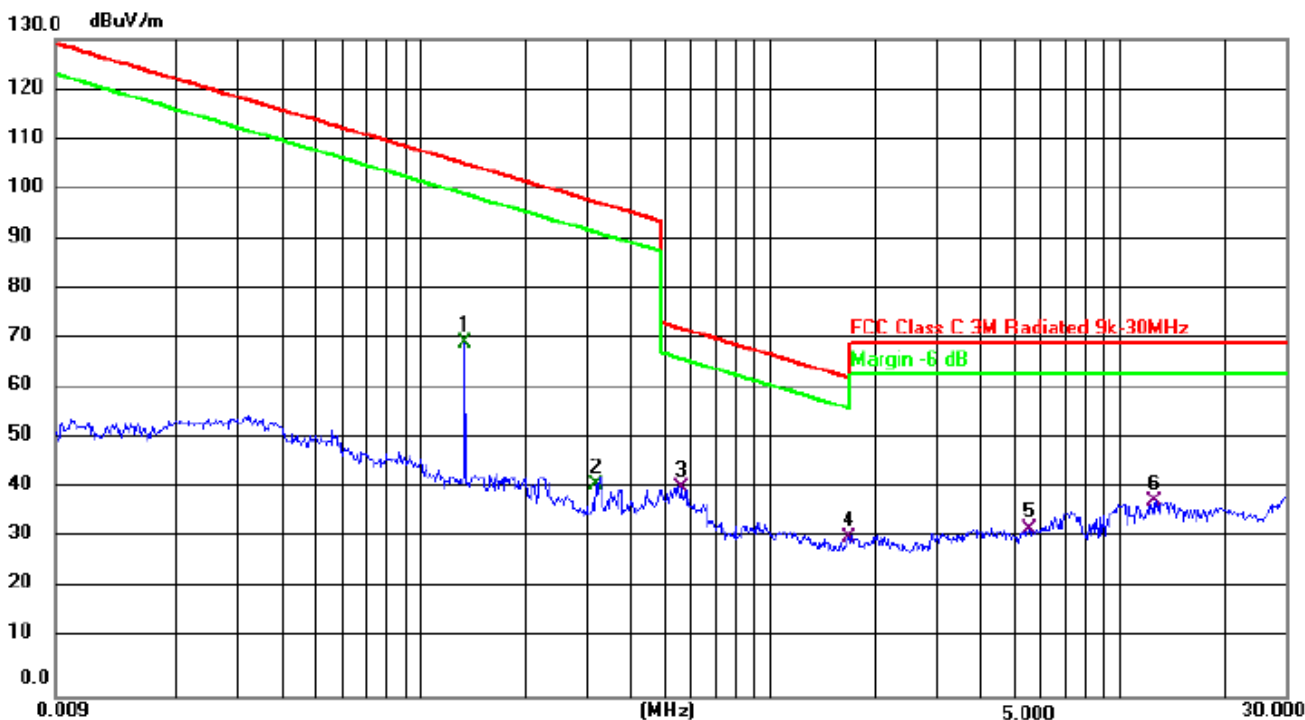

Frequency (MHz)	Meter Reading (dBμV)	Factor (dB)	Emission Level (dBμV/m)	Limits (dBμV/m)	Margin (dB)	Detector Type
0.1340	69.92	10.22	80.14	105.35	-25.21	Peak
0.3168	41.14	10.47	51.61	97.82	-46.21	Peak
0.5544	40.58	10.88	51.46	72.91	-21.45	Peak
1.6710	29.91	10.23	40.14	63.18	-23.04	Peak
5.5060	30.85	10.18	41.03	70	-28.97	Peak
12.6965	36.95	10.69	47.64	70	-22.36	Peak

Note:

Pre-scan in the all of mode, the worst case in of was recorded.

Factor = antenna factor + cable loss – pre-amplifier.

Margin = Emission Level(Meter Reading+ Factor) - Limit.



Radiation Emission Test Data			
Temperature:	24.5 °C	Relative Humidity:	54%
Pressure:	1009hPa	Polarization:	Horizontal
Test Voltage:	AC 120V/60Hz	Test Mode:	Mode 1(Mobile)

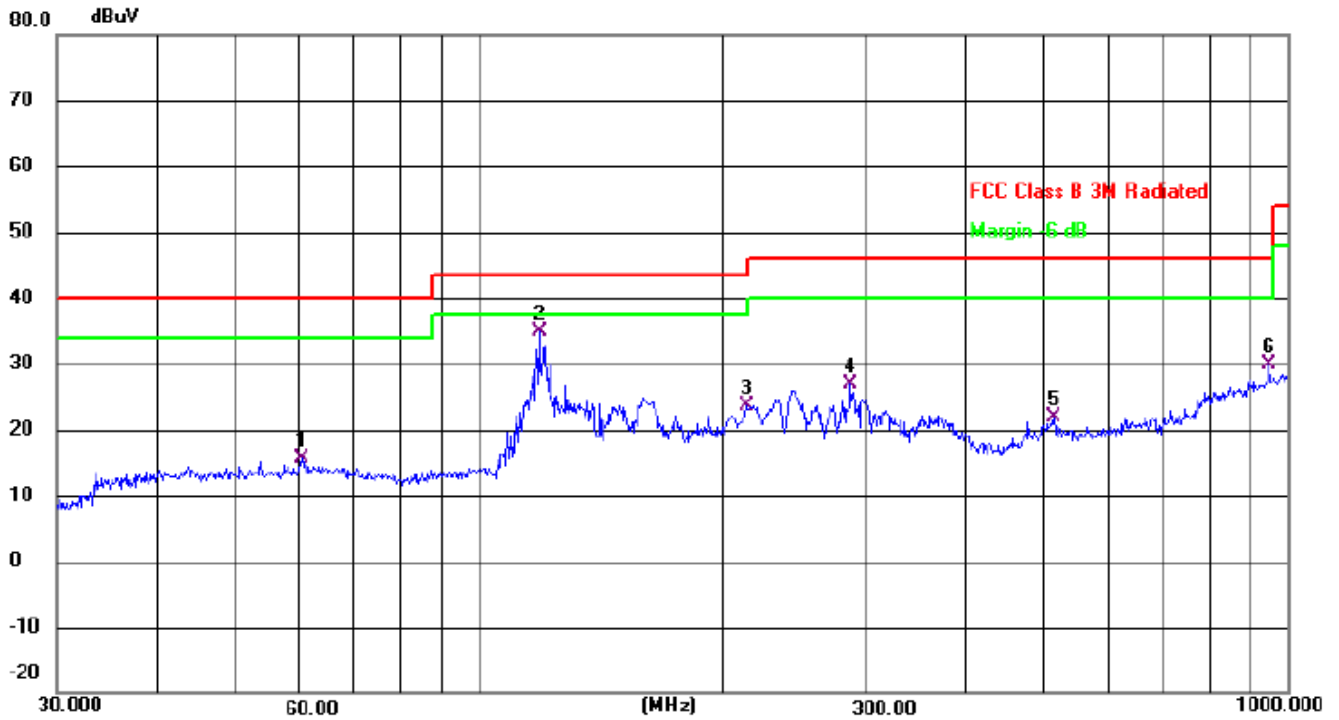

No.	Mk.	Freq. MHz	Reading Level dBuV	Correct Factor dB	Measure- ment dBuV	Limit dB	Margin dB	Detector
1		60.2800	28.34	-12.77	15.57	40.00	-24.43	QP
2	*	118.6012	51.42	-16.50	34.92	43.50	-8.58	QP
3		213.7632	37.80	-14.19	23.61	43.50	-19.89	QP
4		287.9904	38.61	-11.74	26.87	46.00	-19.13	QP
5		513.6331	29.27	-7.34	21.93	46.00	-24.07	QP
6		948.7608	29.74	0.20	29.94	46.00	-16.06	QP



Radiation Emission Test Data			
Temperature:	24.5 °C	Relative Humidity:	54%
Pressure:	1009hPa	Polarization:	Vertical
Test Voltage:	AC 120V/60Hz	Test Mode:	Mode 1(Mobile)

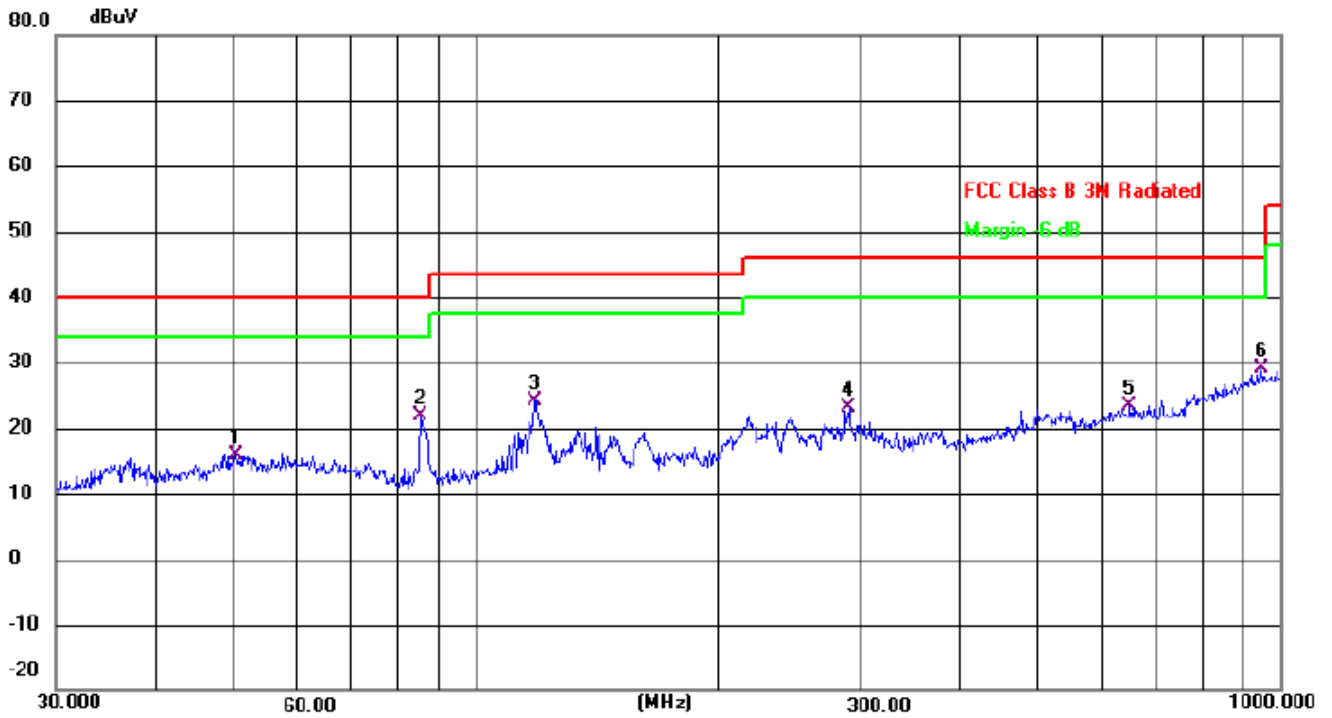

No.	Mk.	Freq.	Reading Level	Correct Factor	Measurement	Limit	Margin	Detector
		MHz	dBuV	dB	dBuV	dB	dB	
1		50.2323	29.12	-13.20	15.92	40.00	-24.08	QP
2		85.2980	39.17	-17.26	21.91	40.00	-18.09	QP
3		118.1860	40.68	-16.50	24.18	43.50	-19.32	QP
4		291.0358	34.85	-11.65	23.20	46.00	-22.80	QP
5		649.6594	28.48	-5.01	23.47	46.00	-22.53	QP
6	*	948.7608	28.94	0.20	29.14	46.00	-16.86	QP

Remarks:

1. Final Level = Receiver Read level + Correct factor (Antenna Factor + Cable Loss – Pre-amplifier Factor )
2. The emission levels of other frequencies are very lower than the limit and not show in test report.





Radiation Emission Test Data			
Temperature:	24.5 °C	Relative Humidity:	54%
Pressure:	1009hPa	Polarization:	Horizontal
Test Voltage:	DC 3.85V	Test Mode:	Mode 4(Portable)

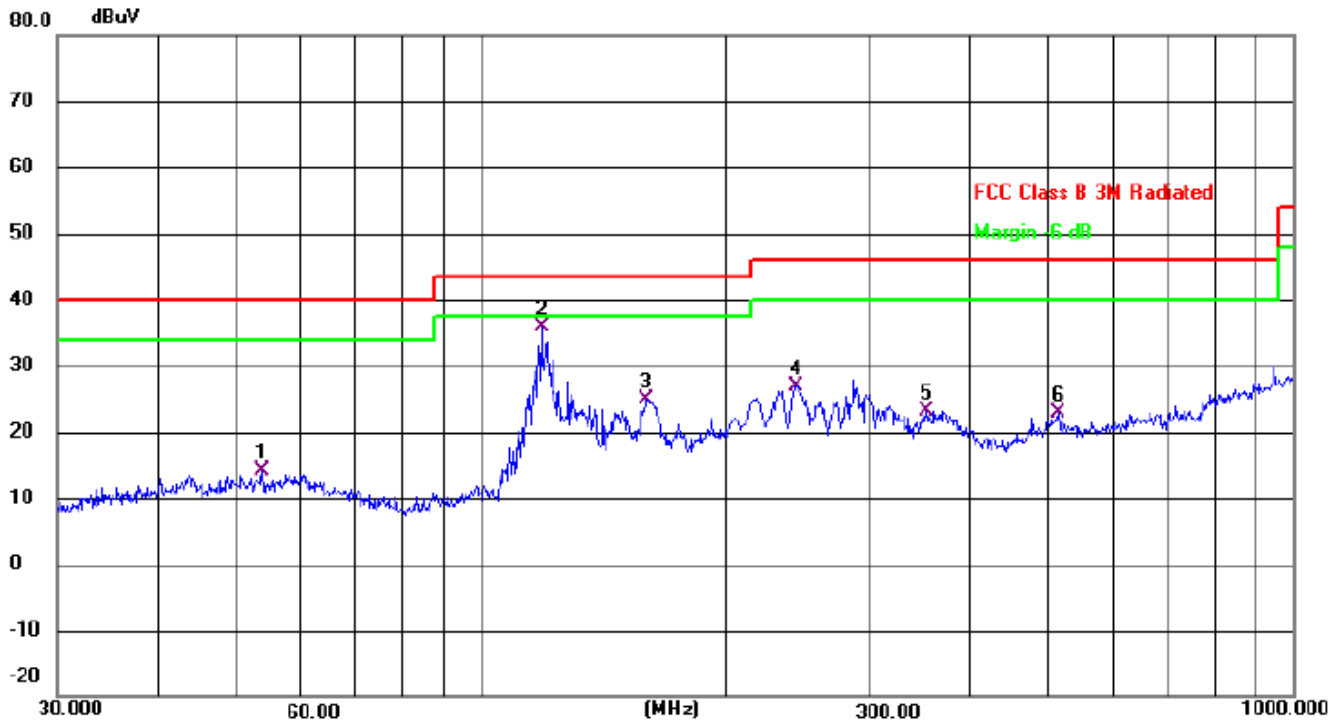

No.	Mk.	Freq. MHz	Reading Level dBuV	Correct Factor dB	Measure- ment dBuV	Limit dB	Margin dB	Detector
1		53.6931	27.26	-13.03	14.23	40.00	-25.77	QP
2	*	118.6012	52.42	-16.50	35.92	43.50	-7.58	QP
3		159.7844	42.14	-17.22	24.92	43.50	-18.58	QP
4		244.2321	39.85	-12.96	26.89	46.00	-19.11	QP
5		352.9433	33.75	-10.56	23.19	46.00	-22.81	QP
6		513.6331	30.27	-7.34	22.93	46.00	-23.07	QP



Radiation Emission Test Data			
Temperature:	24.5 °C	Relative Humidity:	54%
Pressure:	1009hPa	Polarization:	Vertical
Test Voltage:	DC 3.85V	Test Mode:	Mode 4(Portable)

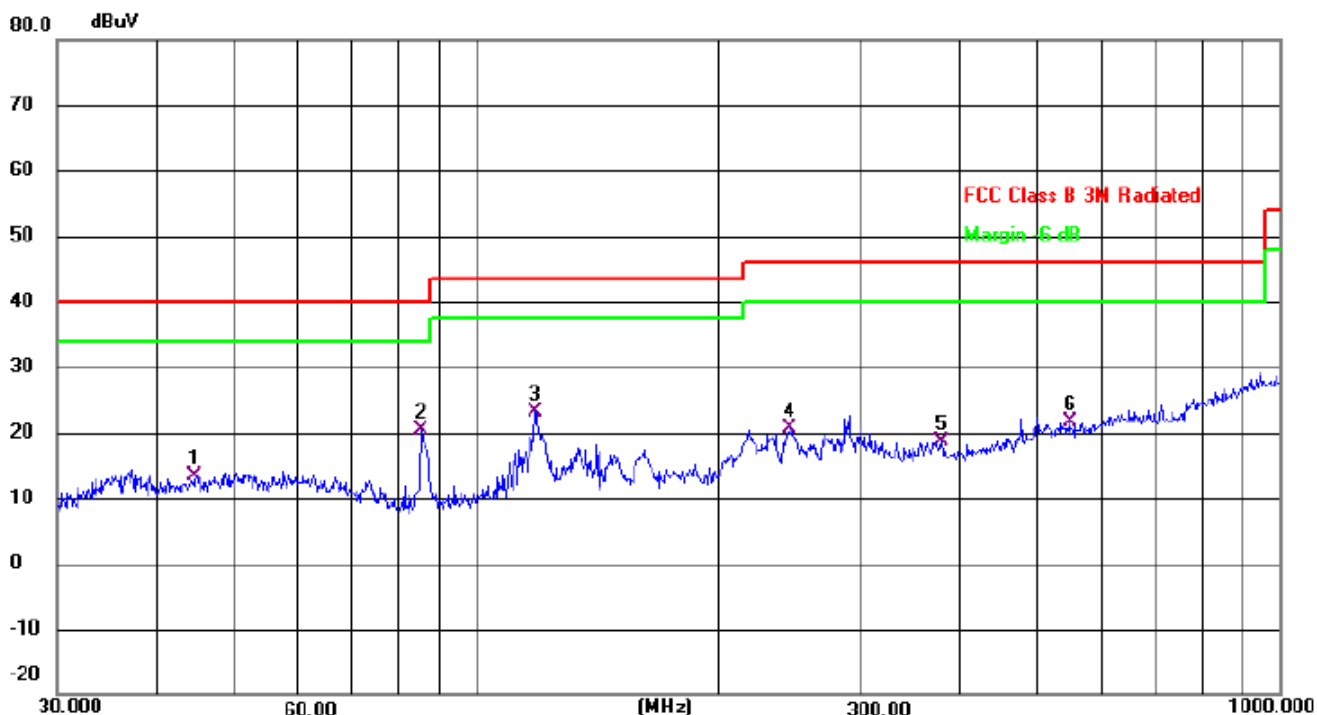

No.	Mk.	Freq. MHz	Reading Level dBuV	Correct Factor dB	Measure- ment dBuV	Limit dB	Margin dB	Detector
1		44.7433	26.79	-13.53	13.26	40.00	-26.74	QP
2	*	85.2980	37.67	-17.26	20.41	40.00	-19.59	QP
3		118.1862	39.68	-16.50	23.18	43.50	-20.32	QP
4		245.0900	33.66	-12.93	20.73	46.00	-25.27	QP
5		378.5843	28.71	-10.13	18.58	46.00	-27.42	QP
6		547.0977	28.54	-6.87	21.67	46.00	-24.33	QP

Remarks:

- 1.Final Level =Receiver Read level + Correct factor (Antenna Factor + Cable Loss – Pre-amplifier Factor )
- 2.The emission levels of other frequencies are very lower than the limit and not show in test report.



**7. BANDWIDTH TEST**

**7.1 TEST SETUP**

1. Set RBW = 3KHz.
2. Set the video bandwidth (VBW)  $\geq 3 \times$  RBW.
3. Detector = Peak.
4. Trace mode = max hold.
5. Sweep = auto couple.
6. Allow the trace to stabilize.
7. Measure the maximum width of the emission that is constrained by the frequencies associated with the two outermost amplitude points (upper and lower frequencies) that are attenuated by 20 dB relative to the maximum level measured in the fundamental emission.

**7.2 TEST SETUP**



**7.3 TEST Result**

Frequency (KHz)	20dB bandwidth (KHz)	Result
138	8.170	Pass





**8. SETUP PHOTOGRAPHS**

Reference to the setup photo for details.

**9. EUT PHOTOGRAPHS**

Reference to the external and internal photo for details.

**\*\*\*\*\* END OF REPORT \*\*\*\*\***