



CTC Laboratories, Inc.

2/F., Building 1 and 1-2/F., Building 2, Jiaquan Building, Guanlan High-Tech Park, Longhua District, Shenzhen, Guangdong, China
Tel : +86-0755-27521059 Fax: +86-0755-27521011 http://www.sz-ctc.org.cn

TEST REPORT

Report No.: **CTC20221226E04**

FCC ID.....: **2A482-U2-PRO**

Applicant.....: **Shenzhen Baseus Technology Co., Ltd.**

Address.....: 2th Floor, Building B, Baseus Intelligence Park, No.2008, Xuegang Rd, Gangtou Community, Bantian Street, Longgang District, Shenzhen China

Manufacturer.....: Shenzhen Baseus Technology Co., Ltd.

Address.....: 2th Floor, Building B, Baseus Intelligence Park, No.2008, Xuegang Rd, Gangtou Community, Bantian Street, Longgang District, Shenzhen China

Product Name.....: **Baseus Neckband Noise-Cancellation Wireless Earphones**

Trade Mark.....: Baseus

Model/Type reference.....: Baseus Bowie U2 Pro

Listed Model(s): /

Standard.....: **FCC CFR Title 47 Part 15 Subpart C Section 15.247**

Date of receipt of test sample...: Jun. 14, 2022

Date of testing.....: Jun. 14, 2022 to Jun. 27, 2022

Date of issue.....: Jun. 27, 2022

Result.....: **PASS**

Compiled by:
(Printed name+signature) Jim Jiang *Jim Jiang*

Supervised by:
(Printed name+signature) Miller Ma *Miller Ma*

Approved by:
(Printed name+signature) Totti Zhao *Totti Zhao*

This test report may be duplicated completely for legal use with the approval of the applicant. It should not be reproduced except in full, without the written approval of our laboratory. The client should not use it to claim product endorsement by CTC. The test results in the report only apply to the tested sample. The test report shall be invalid without all the signatures of testing engineers, reviewer and approver. Any objections must be raised to CTC within 15 days since the date when the report is received. It will not be taken into consideration beyond this limit. The test report merely correspond to the test sample.



Table of Contents

Page

- 1. TEST SUMMARY 3
 - 1.1. TEST STANDARDS..... 3
 - 1.2. REPORT VERSION 3
 - 1.3. TEST DESCRIPTION..... 3
 - 1.4. TEST FACILITY 4
 - 1.5. MEASUREMENT UNCERTAINTY 4
 - 1.6. ENVIRONMENTAL CONDITIONS..... 5
- 2. GENERAL INFORMATION 6
 - 2.1. CLIENT INFORMATION 6
 - 2.2. GENERAL DESCRIPTION OF EUT 6
 - 2.3. ACCESSORY EQUIPMENT INFORMATION 7
 - 2.4. OPERATION STATE 8
 - 2.5. MEASUREMENT INSTRUMENTS LIST 9
- 3. TEST ITEM AND RESULTS 11
 - 3.1. CONDUCTED EMISSION..... 11
 - 3.2. RADIATED EMISSION 14
 - 3.3. BAND EDGE EMISSIONS (RADIATED) 25
 - 3.4. BAND EDGE AND SPURIOUS EMISSIONS (CONDUCTED) 34
 - 3.5. BANDWIDTH..... 45
 - 3.6. CHANNEL SEPARATION..... 50
 - 3.7. NUMBER OF HOPPING CHANNEL 52
 - 3.8. DWELL TIME 54
 - 3.9. PEAK OUTPUT POWER 58
 - 3.10. DUTY CYCLE 59
 - 3.11. ANTENNA REQUIREMENT 62



1. TEST SUMMARY

1.1. Test Standards

The tests were performed according to following standards:

[FCC Rules Part 15.247](#): Operation within the bands of 902-928MHz, 2400-2483.5MHz, and 5725-5850MHz.

[RSS-247 Issue 2](#): Standard Specifications for Frequency Hopping Systems (FHSs) and Digital Transmission Systems (DTSs) Operating in the Bands 902-928MHz, 2400-2483.5MHz and 5725-5850MHz.

[ANSI C63.10-2013](#): American National Standard for Testing Unlicensed Wireless Devices.

1.2. Report Version

Revised No.	Date of issue	Description
01	Jun. 27, 2022	Original

1.3. Test Description

FCC Part 15 Subpart C (15.247)/ RSS-247 Issue 2				
Test Item	Standard Section		Result	Test Engineer
	FCC	IC		
Antenna Requirement	15.203	/	Pass	Jim Jiang
Conducted Emission	15.207	RSS-Gen 8.8	Pass	Jim Jiang
Restricted Bands	15.205	RSS-Gen 8.10	Pass	Jim Jiang
Hopping Channel Separation	15.247(a)(1)	RSS-247 5.1 (b)	Pass	Jim Jiang
Dwell Time	15.247(a)(iii)	RSS-247 5.1 (d)	Pass	Jim Jiang
Peak Output Power	15.247(b)(1)	RSS-247 5.4 (b)	Pass	Jim Jiang
Number of Hopping Frequency	15.247(a)(iii)	RSS-247 5.1 (d)	Pass	Jim Jiang
Band Edge Emissions	15.247(d)	RSS-247 5.5	Pass	Jim Jiang
Radiated Spurious Emission	15.247(d)&15.209	RSS-247 5.5& RSS-Gen 8.9	Pass	Jim Jiang
20dB Bandwidth	15.247(a)	RSS-247 5.1 (b)	Pass	Jim Jiang

Note: The measurement uncertainty is not included in the test result.



1.4. Test Facility

CTC Laboratories, Inc.

Add: 1-2/F., Building 2, Jiaquan Building, Guanlan High-Tech Park, Shenzhen, Guangdong, China

Laboratory accreditation

The test facility is recognized, certified, or accredited by the following organizations:

A2LA-Lab Cert. No.: 4340.01

CTC Laboratories, Inc. EMC Laboratory has been accredited by A2LA for technical competence in the field of electrical testing, and proved to be in compliance with ISO/IEC 17025:2017 General Requirements for the Competence of Testing and Calibration Laboratories and any additional program requirements in the identified field of testing.

Industry Canada (Registration No.: 9783A, CAB Identifier: CN0029)

CTC Laboratories, Inc. EMC Laboratory has been registered by Certification and Engineer Bureau of Industry Canada for the performance of with Registration NO.: 9783A on Jan, 2016.

FCC (Registration No.: 951311, Designation Number CN1208)

CTC Laboratories, Inc. EMC Laboratory has been registered and fully described in a report filed with the (FCC) Federal Communications Commission. The acceptance letter from the FCC is maintained in our files. Registration 951311, Aug 26, 2017.

1.5. Measurement Uncertainty

The data and results referenced in this document are true and accurate. The reader is cautioned that there may be errors within the calibration limits of the equipment and facilities. The measurement uncertainty was calculated for all measurements listed in this test report acc. to TR-100028-01 "Electromagnetic compatibility and Radio spectrum Matters (ERM); Uncertainties in the measurement of mobile radio equipment characteristics; Part 1" and TR-100028-02 "Electromagnetic compatibility and Radio spectrum Matters (ERM); Uncertainties in the measurement of mobile radio equipment characteristics; Part 2" and is documented in the CTC Laboratories, Inc. quality system acc. to DIN EN ISO/IEC 17025. Furthermore, component and process variability of devices similar to that tested may result in additional deviation. The manufacturer has the sole responsibility of continued compliance of the device.

Below is the best measurement capability for CTC Laboratories, Inc.



Test Items	Measurement Uncertainty	Notes
Transmitter power conducted	0.42 dB	(1)
Transmitter power Radiated	2.14 dB	(1)
Conducted spurious emissions 9kHz~40GHz	1.60 dB	(1)
Radiated spurious emissions 9kHz~40GHz	2.20 dB	(1)
Conducted Emissions 9kHz~30MHz	3.20 dB	(1)
Radiated Emissions 30~1000MHz	4.70 dB	(1)
Radiated Emissions 1~18GHz	5.00 dB	(1)
Radiated Emissions 18~40GHz	5.54 dB	(1)
Occupied Bandwidth	-----	(1)

Note (1): This uncertainty represents an expanded uncertainty expressed at approximately the 95% confidence level using a coverage factor of k=2.

1.6. Environmental Conditions

During the measurement the environmental conditions were within the listed ranges:

Temperature:	21°C~27°C
Relative Humidity:	40%~60%
Atmospheric Pressure:	101kPa



2. GENERAL INFORMATION

2.1. Client Information

Applicant:	Shenzhen Baseus Technology Co., Ltd.
Address:	2th Floor, Building B, Baseus Intelligence Park, No.2008, Xuegang Rd, Gangtou Community, Bantian Street, Longgang District, Shenzhen China
Manufacturer:	Shenzhen Baseus Technology Co., Ltd.
Address:	2th Floor, Building B, Baseus Intelligence Park, No.2008, Xuegang Rd, Gangtou Community, Bantian Street, Longgang District, Shenzhen China
Factory:	Guangdong Yiming Acoustic Technology Co., Ltd
Address:	111, Nanjiang Road, Humen Town, Dongguan City, China

2.2. General Description of EUT

Product Name:	Baseus Neckband Noise-Cancellation Wireless Earphones
Trade Mark:	Baseus
Model/Type reference:	Baseus Bowie U2 Pro
Listed Model(s):	/
Model Difference:	/
Power supply:	Input: DC5V 250mA DC3.7V 110mAh from Battery
Hardware version:	/
Software version:	/
Bluetooth 5.2/ EDR	
Modulation:	GFSK, $\pi/4$ -DQPSK
Operation frequency:	2402MHz~2480MHz
Channel number:	79
Channel separation:	1MHz
Antenna type:	FPC Antenna
Antenna gain:	1.0dBi



2.3. Accessory Equipment Information

Equipment Information			
Name	Model	S/N	Manufacturer
Notebook	ThinkPad T460s	/	Lenovo
Cable Information			
Name	Shielded Type	Ferrite Core	Length
USB Cable	Unshielded	NO	100cm
Test Software Information			
Name	Version	/	/
BT_Tool	1.1.2	/	/



2.4. Operation State

Operation Frequency List: The EUT has been tested under typical operating condition. The Applicant provides communication tools software to control the EUT for staying in continuous transmitting and receiving mode for testing. BT EDR, 79 channels are provided to the EUT. Channels 00/39/78 were selected for testing.

Operation Frequency List:

Channel	Frequency (MHz)
00	2402
01	2403
:	:
38	2440
39	2441
40	2442
:	:
77	2479
78	2480

Note: The display in grey were the channel selected for testing.

Test mode

For RF test items:
The engineering test program was provided and enabled to make EUT continuous transmit
For AC power line conducted emissions:
The EUT was set to connect with the Bluetooth instrument under large package sizes transmission.
For Radiated spurious emissions test item:
The engineering test program was provided and enabled to make EUT continuous transmit. The EUT in each of three orthogonal axis emissions had been tested, but only the worst case (X axis) data recorded in the report.



2.5. Measurement Instruments List

Tonscend JS0806-2 Test system					
Item	Test Equipment	Manufacturer	Model No.	Serial No.	Calibrated until
1	Spectrum Analyzer	Rohde & Schwarz	FSU26	100105	Dec. 23, 2022
2	Spectrum Analyzer	Rohde & Schwarz	FUV40-N	101331	Mar. 15, 2023
3	MXG Vector Signal Generator	Agilent	N5182A	MY47420864	Dec. 23, 2022
4	Signal Generator	Agilent	E8257D	MY46521908	Dec. 23, 2022
5	Power Sensor	Agilent	U2021XA	MY5365004	Mar. 15, 2023
6	Power Sensor	Agilent	U2021XA	MY5365006	Mar. 15, 2023
7	Simultaneous Sampling DAQ	Agilent	U2531A	TW54493510	Mar. 15, 2023
8	Climate Chamber	TABAI	PR-4G	A8708055	Dec. 23, 2022
9	Wideband Radio Communication Tester	Rohde & Schwarz	CMW500	116410	Dec. 23, 2022
10	Climate Chamber	ESPEC	MT3065	/	Dec. 23, 2022
11	300328 v2.2.2 test system	TONSCEND	v2.6	/	/

Radiated Emission and Transmitter spurious emission					
Item	Test Equipment	Manufacturer	Model No.	Serial No.	Calibrated until
1	Trilog-Broadband Antenna	Schwarzbeck	VULB 9168	9168-759	Nov. 09, 2022
2	Horn Antenna	Schwarzbeck	BBHA 9120D	9120D-647	Dec. 23, 2022
3	Test Receiver	Keysight	N9038A	MY56400071	Dec. 23, 2022
4	Broadband Prempplier	SCHWARZBECK	BBV9743B	259	Dec. 23, 2022
5	Mirowave Broadband Amplifier	SCHWARZBECK	BBV9718C	111	Dec. 23, 2022
6	3m chamber 3	YIHENG	EE106	/	Sep. 09, 2023



Conducted Emission					
Item	Test Equipment	Manufacturer	Model No.	Serial No.	Calibrated until
1	LISN	R&S	ENV216	101112	Dec. 23, 2022
2	LISN	R&S	ENV216	101113	Dec. 23, 2022
3	EMI Test Receiver	R&S	ESCS30	100353	Dec. 23, 2022
4	ISN CAT6	Schwarzbeck	NTFM 8158	CAT6-8158-0046	Dec. 23, 2022
5	ISN CAT5	Schwarzbeck	NTFM 8158	CAT5-8158-0046	Dec. 23, 2022

Note:

1. The Cal. Interval was one year.
2. The cable loss has calculated in test result which connection between each test instruments.

3. TEST ITEM AND RESULTS

3.1. Conducted Emission

Limit

FCC CFR Title 47 Part 15 Subpart C Section 15.207/ RSS – Gen 8.8

Frequency range (MHz)	Limit (dBuV)	
	Quasi-peak	Average
0.15-0.5	66 to 56*	56 to 46*
0.5-5	56	46
5-30	60	50

* Decreases with the logarithm of the frequency.

Test Configuration

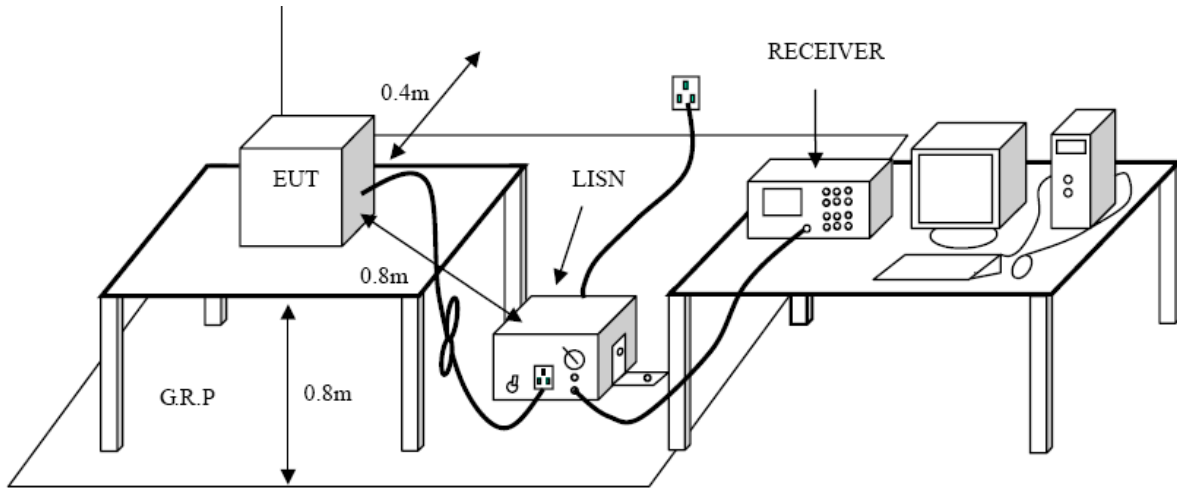

Test Procedure

1. The EUT was setup according to ANSI C63.10:2013 requirements.
2. The EUT was placed on a platform of nominal size, 1 m by 1.5 m, raised 80 cm above the conducting ground plane. The vertical conducting plane was located 40 cm to the rear of the EUT. All other surfaces of EUT were at least 80 cm from any other grounded conducting surface.
3. The EUT and simulators are connected to the main power through a line impedances stabilization network (LISN). The LISN provides a 50ohm /50uH coupling impedance for the measuring equipment. The peripheral devices are also connected to the main power through a LISN. (Please refer to the block diagram of the test setup and photographs)
4. Each current-carrying conductor of the EUT power cord, except the ground (safety) conductor, was individually connected through a LISN to the input power source.
5. The excess length of the power cord between the EUT and the LISN receptacle were folded back and forth at the center of the lead to form a bundle not exceeding 40 cm in length.
6. Conducted Emissions were investigated over the frequency range from 0.15MHz to 30MHz using a receiver bandwidth of 9 kHz.
7. During the above scans, the emissions were maximized by cable manipulation.

Test Mode

Please refer to the clause 2.4.



Test Results

Test Voltage:	AC 120V/60 Hz
Terminal:	Line

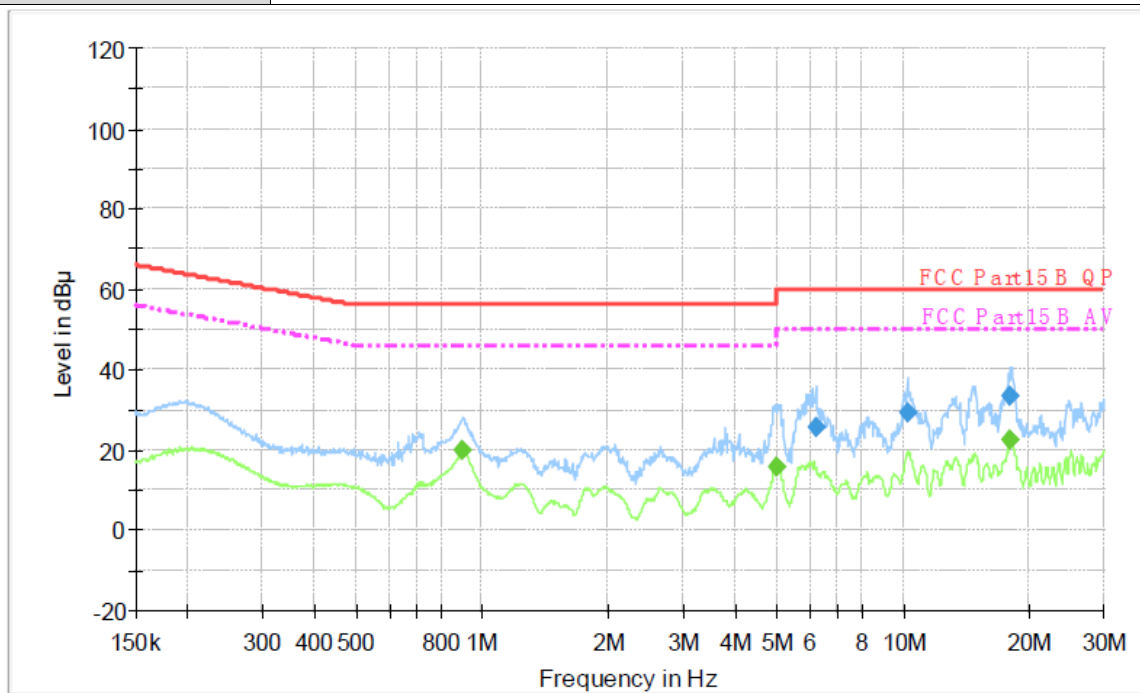

Final Measurement Detector 1

Frequency (MHz)	QuasiPeak (dBu V)	Meas. Time (ms)	Bandwidth (kHz)	Filter	Line	Corr. (dB)	Margin (dB)	Limit (dBu V)	Comment
6.193150	25.8	1000.00	9.000	On	L1	9.7	34.2	60.0	
10.241410	29.3	1000.00	9.000	On	L1	9.8	30.7	60.0	
17.980970	33.2	1000.00	9.000	On	L1	9.9	26.8	60.0	

Final Measurement Detector 2

Frequency (MHz)	Average (dBu V)	Meas. Time (ms)	Bandwidth (kHz)	Filter	Line	Corr. (dB)	Margin (dB)	Limit (dBu V)	Comment
0.900590	19.8	1000.00	9.000	On	L1	9.7	26.2	46.0	
4.992190	15.8	1000.00	9.000	On	L1	9.7	30.2	46.0	
18.052900	22.6	1000.00	9.000	On	L1	9.9	27.4	50.0	

Emission Level= Read Level+ Correct Factor



Test Voltage:	AC 120V/60 Hz
Terminal:	Neutral

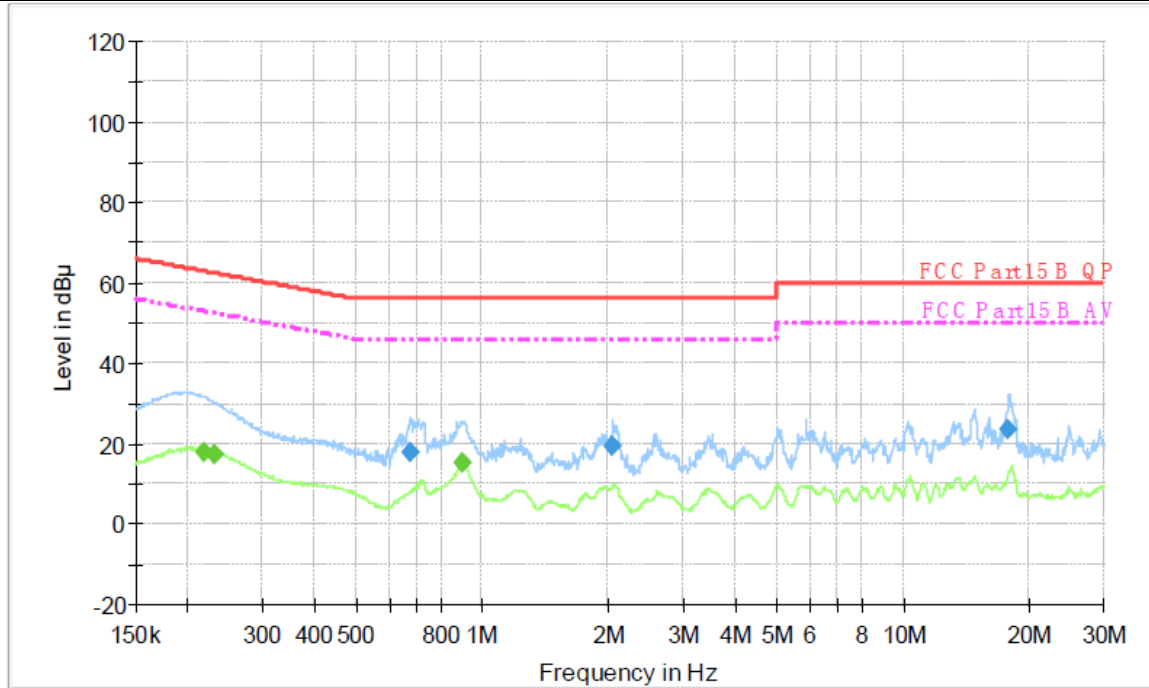

Final Measurement Detector 1

Frequency (MHz)	QuasiPeak (dBµ V)	Meas. Time (ms)	Bandwidth (kHz)	Filter	Line	Corr. (dB)	Margin (dB)	Limit (dBµ V)	Comment
0.672930	18.0	1000.00	9.000	On	N	10.0	38.0	56.0	
2.041450	19.3	1000.00	9.000	On	N	10.0	36.7	56.0	
17.837980	23.8	1000.00	9.000	On	N	10.0	36.2	60.0	

Final Measurement Detector 2

Frequency (MHz)	Average (dBµ V)	Meas. Time (ms)	Bandwidth (kHz)	Filter	Line	Corr. (dB)	Margin (dB)	Limit (dBµ V)	Comment
0.219180	17.8	1000.00	9.000	On	N	10.0	35.0	52.8	
0.231770	17.2	1000.00	9.000	On	N	10.0	35.2	52.4	
0.897010	15.5	1000.00	9.000	On	N	10.0	30.6	46.0	

Emission Level= Read Level+ Correct Factor



3.2. Radiated Emission

Limit

FCC CFR Title 47 Part 15 Subpart C Section 15.209/ RSS – Gen 8.9

Frequency (MHz)	Field Strength (microvolts/meter)	Measurement Distance (meters)
0.009~0.490	2400/F(KHz)	300
0.490~1.705	24000/F(KHz)	30
1.705~30.0	30	30
30~88	100	3
88~216	150	3
216~960	200	3
960~1000	500	3

Frequency (MHz)	dB(uV/m) (at 3 meters)	
	Peak	Average
Above 1000	74	54

Note:

- (1) The tighter limit applies at the band edges.
- (2) Emission Level (dBuV/m)=20log Emission Level (uV/m).

Test Configuration

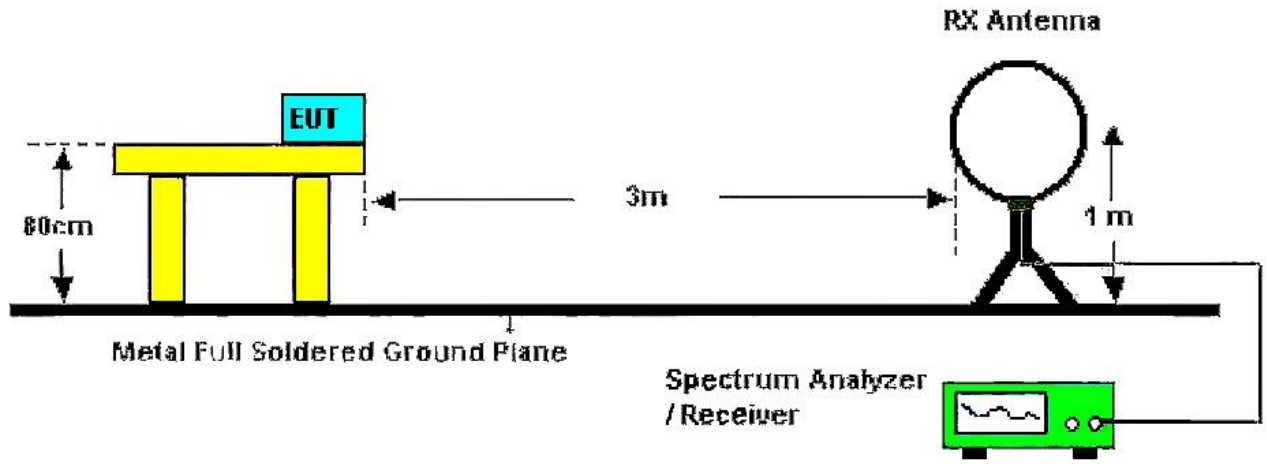

Below 30MHz Test Setup

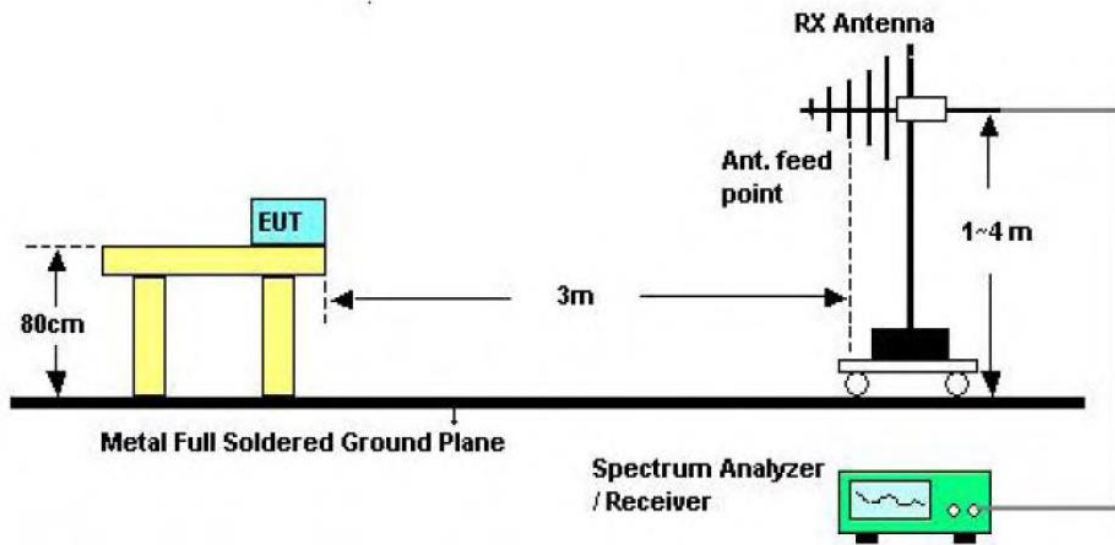

30-1000MHz Test Setup

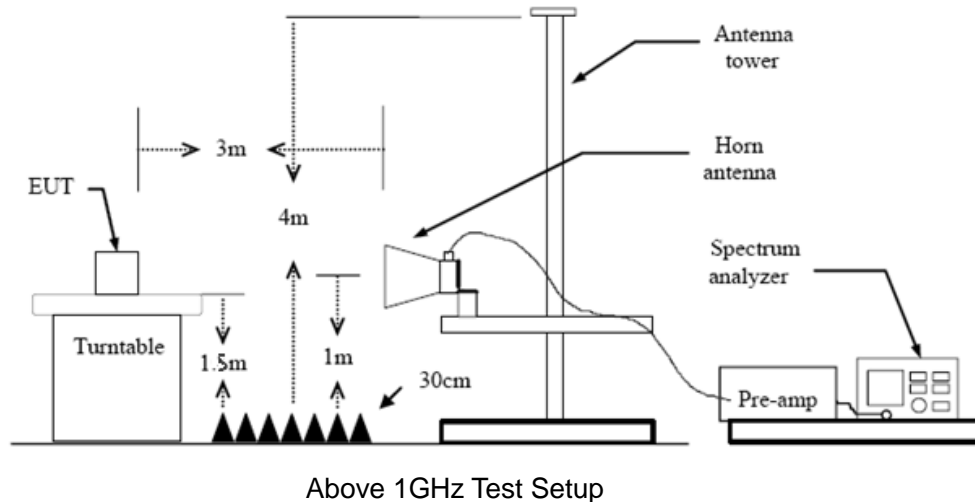

Test Procedure

1. The EUT was setup and tested according to ANSI C63.10:2013
2. The EUT is placed on a turn table which is 0.8 meter above ground for below 1 GHz, and 1.5 m for above 1 GHz. The turn table is rotated 360 degrees to determine the position of the maximum emission level.
3. The EUT was set 3 meters from the receiving antenna, which was mounted on the top of a variable height antenna tower.
4. For each suspected emission, the EUT was arranged to its worst case and then tune the Antenna tower (from 1 m to 4 m) and turntable (from 0 degree to 360 degrees) to find the maximum reading. A pre-amp and a high pass filter are used for the test in order to get better signal level to comply with the guidelines.
5. Set to the maximum power setting and enable the EUT transmit continuously.
6. Use the following spectrum analyzer settings
 - (1) Span shall wide enough to fully capture the emission being measured;
 - (2) Below 1 GHz:
RBW=120 kHz, VBW=300 kHz, Sweep=auto, Detector function=peak, Trace=max hold;
If the emission level of the EUT measured by the peak detector is 3 dB lower than the applicable limit, the peak emission level will be reported. Otherwise, the emission measurement will be repeated using the quasi-peak detector and reported.
 - (3) From 1 GHz to 10th harmonic:
RBW=1MHz, VBW=3MHz Peak detector for Peak value.
RBW=1MHz, VBW=3MHz RMS detector for Average value.

Test Mode

Please refer to the clause 2.4.

Test Result

9 KHz~30 MHz

From 9 KHz to 30 MHz: Conclusion: PASS

Note: The amplitude of spurious emissions which are attenuated by more than 20dB below the permissible value has no need to be reported.



30MHz-1GHz

Ant. Pol.	Horizontal
Test Mode:	TX GFSK Mode 2402MHz
Remark:	Only worse case is reported

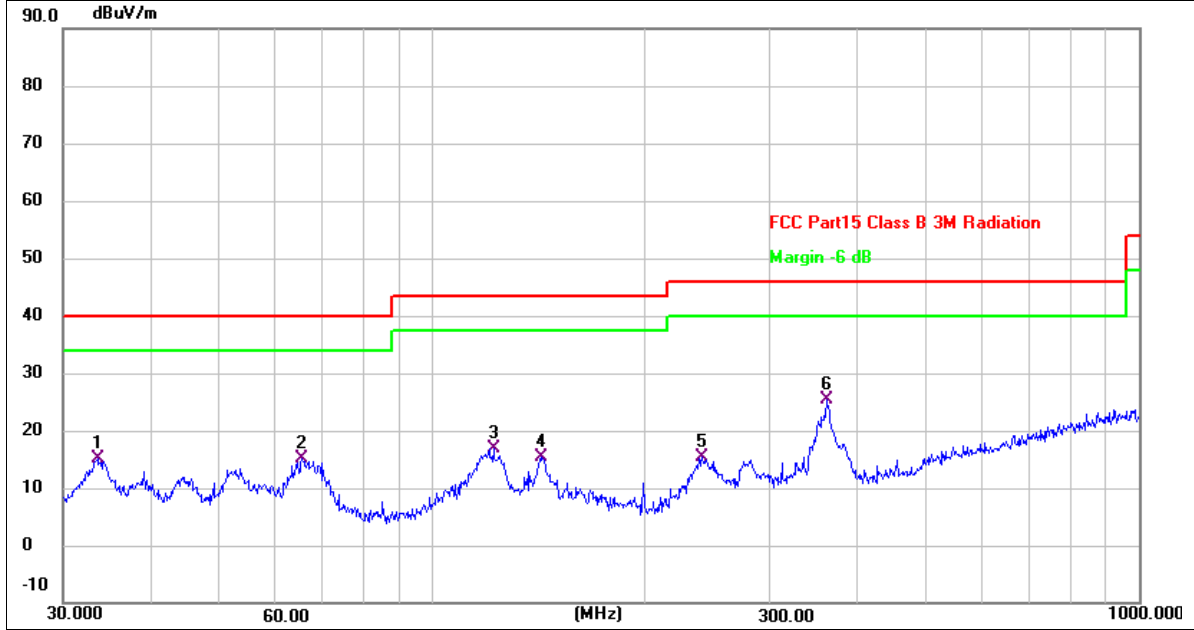

No.	Frequency (MHz)	Reading (dBuV)	Factor (dB/m)	Level (dBuV/m)	Limit (dBuV/m)	Margin (dB)	Detector
1	33.5623	33.25	-18.11	15.14	40.00	-24.86	QP
2	65.3432	34.73	-19.60	15.13	40.00	-24.87	QP
3	121.9755	35.95	-19.14	16.81	43.50	-26.69	QP
4	142.8243	32.85	-17.42	15.43	43.50	-28.07	QP
5	240.8304	34.81	-19.44	15.37	46.00	-30.63	QP
6 *	361.7139	41.83	-16.43	25.40	46.00	-20.60	QP

Remarks:

- Factor (dB/m) = Antenna Factor (dB/m)+Cable Factor (dB)-Pre-amplifier Factor
- Margin value = Level -Limit value



Ant. Pol.	Vertical
Test Mode:	TX GFSK Mode 2402MHz
Remark:	Only worse case is reported

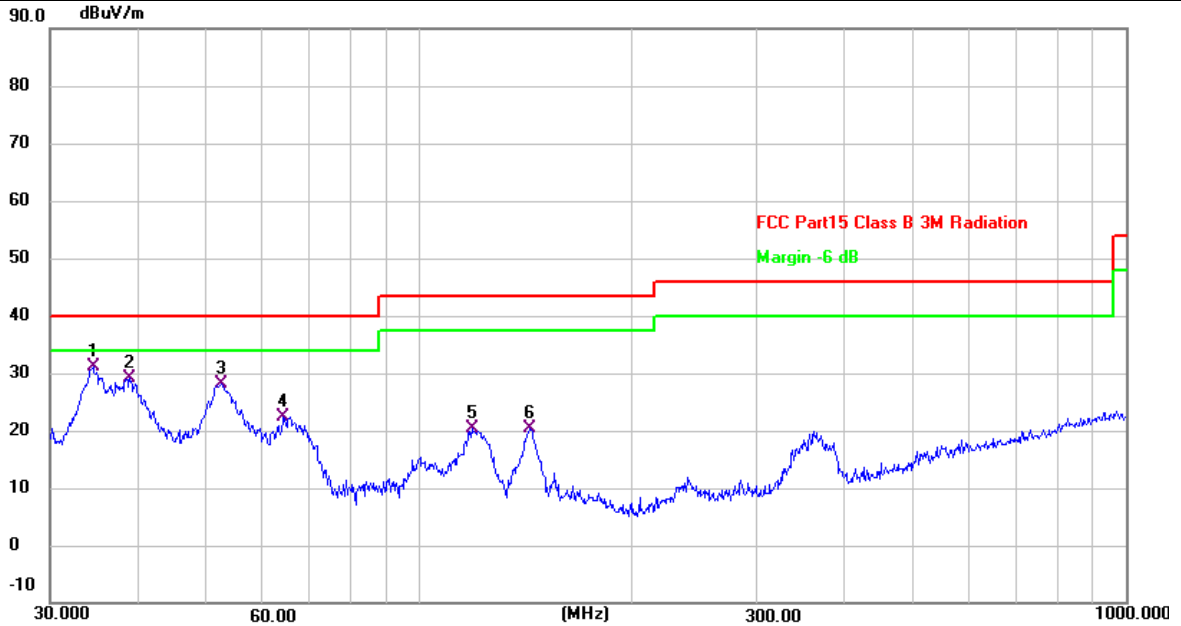

No.	Frequency (MHz)	Reading (dBuV)	Factor (dB/m)	Level (dBuV/m)	Limit (dBuV/m)	Margin (dB)	Detector
1 *	34.5173	49.13	-18.08	31.05	40.00	-8.95	QP
2	38.8878	46.58	-17.51	29.07	40.00	-10.93	QP
3	52.3912	46.13	-18.02	28.11	40.00	-11.89	QP
4	64.2074	41.82	-19.38	22.44	40.00	-17.56	QP
5	118.6014	39.75	-19.42	20.33	43.50	-23.17	QP
6	143.3261	37.87	-17.38	20.49	43.50	-23.01	QP

Remarks:

- Factor (dB/m) = Antenna Factor (dB/m)+Cable Factor (dB)-Pre-amplifier Factor
- Margin value = Level -Limit value



Above 1GHz

Ant. Pol.	Horizontal
Test Mode:	TX GFSK Mode 2402MHz
Remark:	No report for the emission which more than 20 dB below the pre-scribed limit.

No.	Frequency (MHz)	Reading (dBuV)	Factor (dB/m)	Level (dBuV/m)	Limit (dBuV/m)	Margin (dB)	Detector
1 *	4804.131	39.12	-2.82	36.30	54.00	-17.70	AVG
2	4804.146	50.89	-2.82	48.07	74.00	-25.93	peak

Remarks:

- Factor (dB/m) = Antenna Factor (dB/m)+Cable Factor (dB)-Pre-amplifier Factor
- Margin value = Level -Limit value

Ant. Pol.	Vertical
Test Mode:	TX GFSK Mode 2402MHz
Remark:	No report for the emission which more than 20 dB below the pre-scribed limit.

No.	Frequency (MHz)	Reading (dBuV)	Factor (dB/m)	Level (dBuV/m)	Limit (dBuV/m)	Margin (dB)	Detector
1	4804.128	50.12	-2.82	47.30	74.00	-26.70	peak
2 *	4804.142	38.84	-2.82	36.02	54.00	-17.98	AVG

Remarks:

- Factor (dB/m) = Antenna Factor (dB/m)+Cable Factor (dB)-Pre-amplifier Factor
- Margin value = Level -Limit value



Ant. Pol.	Horizontal
Test Mode:	TX GFSK Mode 2441MHz
Remark:	No report for the emission which more than 20 dB below the prescribed limit.

No.	Frequency (MHz)	Reading (dBuV)	Factor (dB/m)	Level (dBuV/m)	Limit (dBuV/m)	Margin (dB)	Detector
1	4881.856	49.74	-2.60	47.14	74.00	-26.86	peak
2 *	4882.020	39.32	-2.60	36.72	54.00	-17.28	AVG

Remarks:

1.Factor (dB/m) = Antenna Factor (dB/m)+Cable Factor (dB)-Pre-amplifier Factor

2.Margin value = Level -Limit value

Ant. Pol.	Vertical
Test Mode:	TX GFSK Mode 2441MHz
Remark:	No report for the emission which more than 20 dB below the prescribed limit.

No.	Frequency (MHz)	Reading (dBuV)	Factor (dB/m)	Level (dBuV/m)	Limit (dBuV/m)	Margin (dB)	Detector
1	4880.988	49.21	-2.60	46.61	74.00	-27.39	peak
2 *	4881.015	37.88	-2.60	35.28	54.00	-18.72	AVG

Remarks:

1.Factor (dB/m) = Antenna Factor (dB/m)+Cable Factor (dB)-Pre-amplifier Factor

2.Margin value = Level -Limit value



Ant. Pol.	Horizontal
Test Mode:	TX GFSK Mode 2480MHz
Remark:	No report for the emission which more than 20 dB below the prescribed limit.

No.	Frequency (MHz)	Reading (dBuV)	Factor (dB/m)	Level (dBuV/m)	Limit (dBuV/m)	Margin (dB)	Detector
1	4960.011	50.07	-2.38	47.69	74.00	-26.31	peak
2 *	4960.064	38.18	-2.38	35.80	54.00	-18.20	AVG

Remarks:

1.Factor (dB/m) = Antenna Factor (dB/m)+Cable Factor (dB)-Pre-amplifier Factor

2.Margin value = Level -Limit value

Ant. Pol.	Vertical
Test Mode:	TX GFSK Mode 2480MHz
Remark:	No report for the emission which more than 20 dB below the prescribed limit.

No.	Frequency (MHz)	Reading (dBuV)	Factor (dB/m)	Level (dBuV/m)	Limit (dBuV/m)	Margin (dB)	Detector
1 *	4960.202	37.80	-2.38	35.42	54.00	-18.58	AVG
2	4960.217	49.16	-2.38	46.78	74.00	-27.22	peak

Remarks:

1.Factor (dB/m) = Antenna Factor (dB/m)+Cable Factor (dB)-Pre-amplifier Factor

2.Margin value = Level -Limit value



Ant. Pol.	Horizontal
Test Mode:	TX $\pi/4$ -DQPSK Mode 2402MHz
Remark:	No report for the emission which more than 20 dB below the pre-scribed limit.

No.	Frequency (MHz)	Reading (dBuV)	Factor (dB/m)	Level (dBuV/m)	Limit (dBuV/m)	Margin (dB)	Detector
1	4804.117	50.12	-2.82	47.30	74.00	-26.70	peak
2 *	4804.122	38.96	-2.82	36.14	54.00	-17.86	AVG

Remarks:

- 1.Factor (dB/m) = Antenna Factor (dB/m)+Cable Factor (dB)-Pre-amplifier Factor
- 2.Margin value = Level -Limit value

Ant. Pol.	Vertical
Test Mode:	TX $\pi/4$ -DQPSK Mode 2402MHz
Remark:	No report for the emission which more than 20 dB below the pre-scribed limit.

No.	Frequency (MHz)	Reading (dBuV)	Factor (dB/m)	Level (dBuV/m)	Limit (dBuV/m)	Margin (dB)	Detector
1	4803.954	49.70	-2.82	46.88	74.00	-27.12	peak
2 *	4804.078	38.84	-2.82	36.02	54.00	-17.98	AVG

Remarks:

- 1.Factor (dB/m) = Antenna Factor (dB/m)+Cable Factor (dB)-Pre-amplifier Factor
- 2.Margin value = Level -Limit value



Ant. Pol.	Horizontal
Test Mode:	TX $\pi/4$ -DQPSK Mode 2441MHz
Remark:	No report for the emission which more than 20 dB below the prescribed limit.

No.	Frequency (MHz)	Reading (dBuV)	Factor (dB/m)	Level (dBuV/m)	Limit (dBuV/m)	Margin (dB)	Detector
1	4881.986	50.14	-2.60	47.54	74.00	-26.46	peak
2 *	4882.013	38.30	-2.60	35.70	54.00	-18.30	AVG

Remarks:

- 1.Factor (dB/m) = Antenna Factor (dB/m)+Cable Factor (dB)-Pre-amplifier Factor
- 2.Margin value = Level -Limit value

Ant. Pol.	Vertical
Test Mode:	TX $\pi/4$ -DQPSK Mode 2441MHz
Remark:	No report for the emission which more than 20 dB below the prescribed limit.

No.	Frequency (MHz)	Reading (dBuV)	Factor (dB/m)	Level (dBuV/m)	Limit (dBuV/m)	Margin (dB)	Detector
1 *	4881.884	38.17	-2.60	35.57	54.00	-18.43	AVG
2	4882.040	49.87	-2.60	47.27	74.00	-26.73	peak

Remarks:

- 1.Factor (dB/m) = Antenna Factor (dB/m)+Cable Factor (dB)-Pre-amplifier Factor
- 2.Margin value = Level -Limit value



Ant. Pol.	Horizontal
Test Mode:	TX $\pi/4$ -DQPSK Mode 2480MHz
Remark:	No report for the emission which more than 20 dB below the prescribed limit.

No.	Frequency (MHz)	Reading (dBuV)	Factor (dB/m)	Level (dBuV/m)	Limit (dBuV/m)	Margin (dB)	Detector
1 *	4960.985	39.07	-2.38	36.69	54.00	-17.31	AVG
2	4961.087	50.20	-2.38	47.82	74.00	-26.18	peak

Remarks:

1.Factor (dB/m) = Antenna Factor (dB/m)+Cable Factor (dB)-Pre-amplifier Factor

2.Margin value = Level -Limit value

Ant. Pol.	Vertical
Test Mode:	TX $\pi/4$ -DQPSK Mode 2480MHz
Remark:	No report for the emission which more than 20 dB below the prescribed limit.

No.	Frequency (MHz)	Reading (dBuV)	Factor (dB/m)	Level (dBuV/m)	Limit (dBuV/m)	Margin (dB)	Detector
1	4959.996	50.35	-2.38	47.97	74.00	-26.03	peak
2 *	4960.132	38.45	-2.38	36.07	54.00	-17.93	AVG

Remarks:

1.Factor (dB/m) = Antenna Factor (dB/m)+Cable Factor (dB)-Pre-amplifier Factor

2.Margin value = Level -Limit value

3.3. Band Edge Emissions (Radiated)

Limit

FCC CFR Title 47 Part 15 Subpart C Section 15.247 (d):

Restricted Frequency Band (MHz)	(dBuV/m)(at 3m)	
	Peak	Average
2310 ~2390	74	54
2483.5 ~2500	74	54

Conducted band edge limit: The highest point of the operating frequency waveform down 20dB

Test Configuration

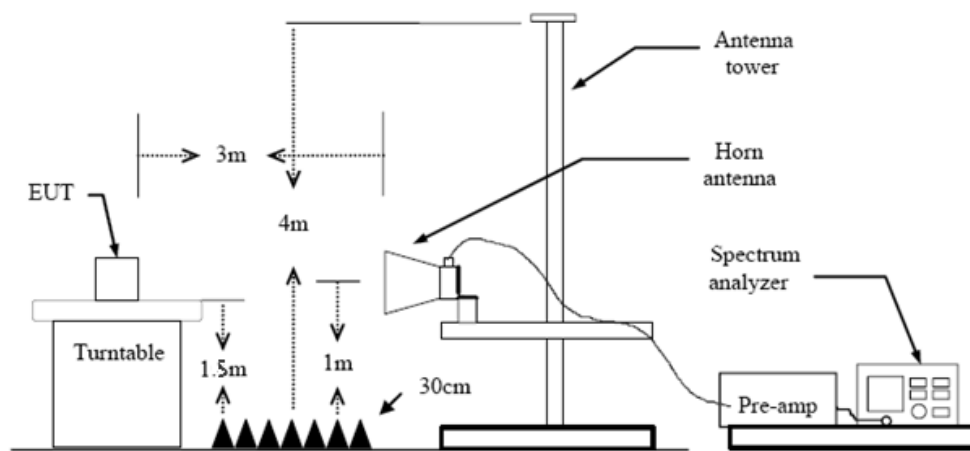

Test Procedure

1. The EUT was setup and tested according to ANSI C63.10:2013 requirements.
2. The EUT is placed on a turn table which is 1.5 meter above ground. The turn table is rotated 360 degrees to determine the position of the maximum emission level.
3. The EUT was positioned such that the distance from antenna to the EUT was 3 meters.
4. The antenna is scanned from 1 meter to 4 meters to find out the maximum emission level. This is repeated for both horizontal and vertical polarization of the antenna. In order to find the maximum emission, all of the interface cables were manipulated according to ANSI C63.10:2013 on radiated measurement.
5. The receiver set as follow:
 RBW=1MHz, VBW=3MHz Peak detector for Peak value.
 RBW=1MHz, VBW see note 1 with Peak Detector for Average Value.

Note 1: For measurements above 1 GHz the resolution bandwidth is set to 1 MHz, then the video bandwidth is set to 3 MHz for peak measurements and 1 MHz resolution bandwidth with 1/T video bandwidth with peak detector for average measurements. For the Duty Cycle please refer to clause 3.10 Duty Cycle.

Test Mode

Please refer to the clause 2.4.



Test Results

(1) Radiation Test

Ant. Pol.	Horizontal
Test Mode:	GFSK Mode 2402MHz

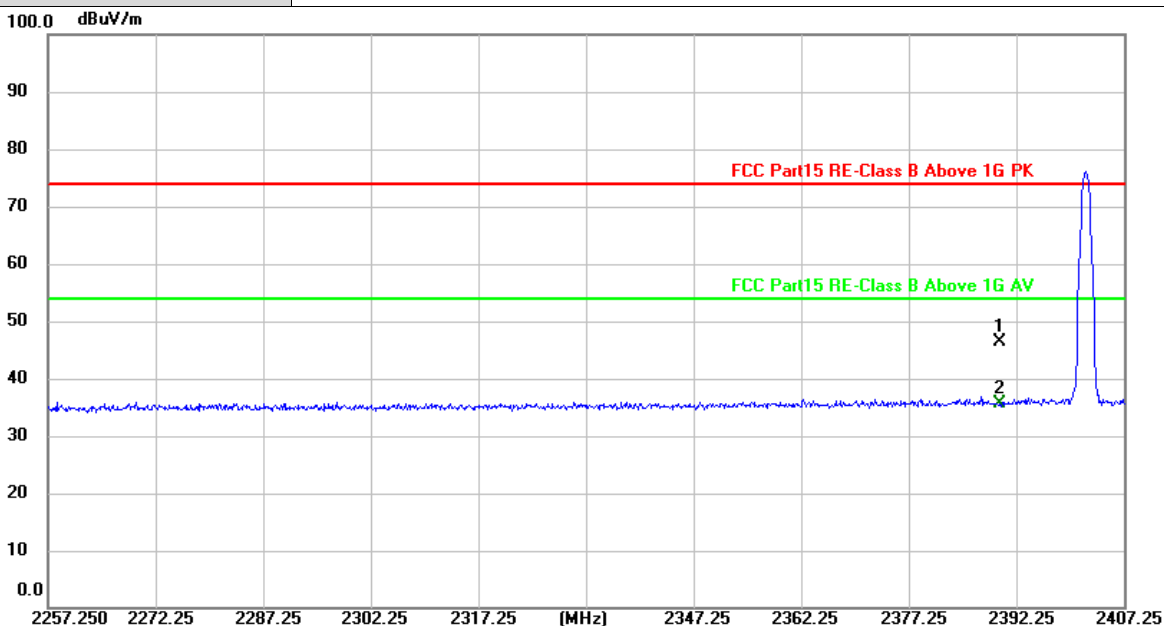

No.	Frequency (MHz)	Reading (dBuV)	Factor (dB/m)	Level (dBuV/m)	Limit (dBuV/m)	Margin (dB)	Detector
1	2390.000	15.65	30.84	46.49	74.00	-27.51	peak
2 *	2390.000	4.90	30.84	35.74	54.00	-18.26	AVG

Remarks:

- 1. Factor (dB/m) = Antenna Factor (dB/m)+Cable Factor (dB)-Pre-amplifier Factor
- 2. Margin value = Level -Limit value



Ant. Pol.	Vertical
Test Mode:	GFSK Mode 2402MHz

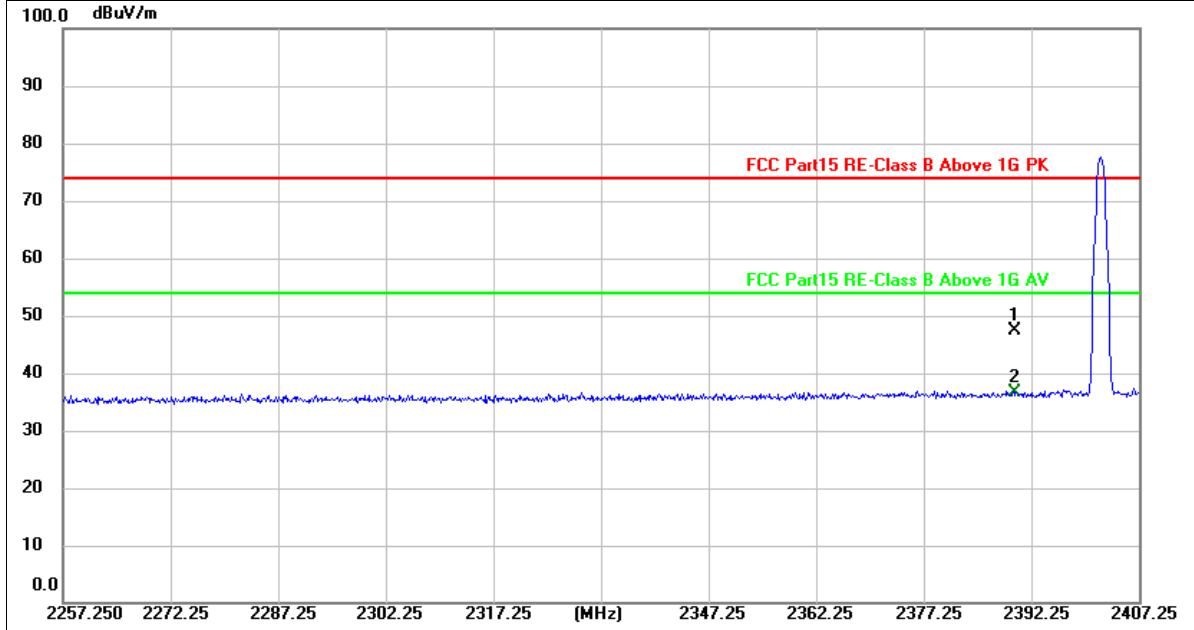

No.	Frequency (MHz)	Reading (dBuV)	Factor (dB/m)	Level (dBuV/m)	Limit (dBuV/m)	Margin (dB)	Detector
1	2390.000	16.61	30.84	47.45	74.00	-26.55	peak
2 *	2390.000	5.82	30.84	36.66	54.00	-17.34	AVG

Remarks:

- 1. Factor (dB/m) = Antenna Factor (dB/m)+Cable Factor (dB)-Pre-amplifier Factor
- 2. Margin value = Level -Limit value



Ant. Pol.	Horizontal
Test Mode:	GFSK Mode 2480 MHz

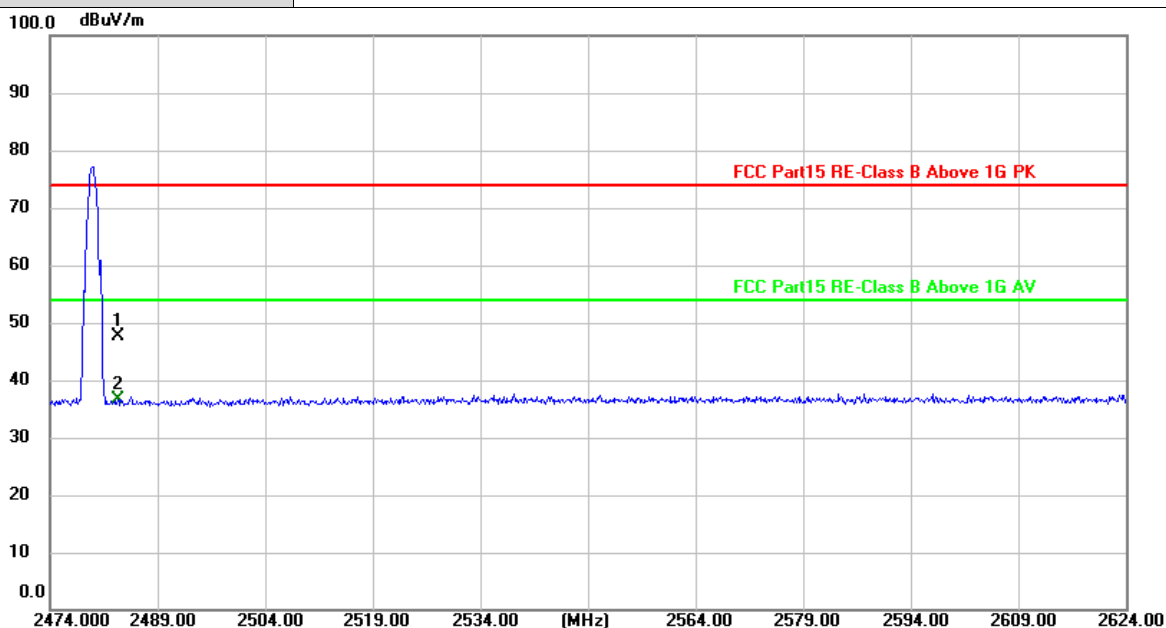

No.	Frequency (MHz)	Reading (dBuV)	Factor (dB/m)	Level (dBuV/m)	Limit (dBuV/m)	Margin (dB)	Detector
1	2483.500	16.46	31.24	47.70	74.00	-26.30	peak
2 *	2483.500	5.36	31.24	36.60	54.00	-17.40	AVG

Remarks:

- 1. Factor (dB/m) = Antenna Factor (dB/m)+Cable Factor (dB)-Pre-amplifier Factor
- 2. Margin value = Level -Limit value





Ant. Pol.	Vertical
Test Mode:	GFSK Mode 2480 MHz

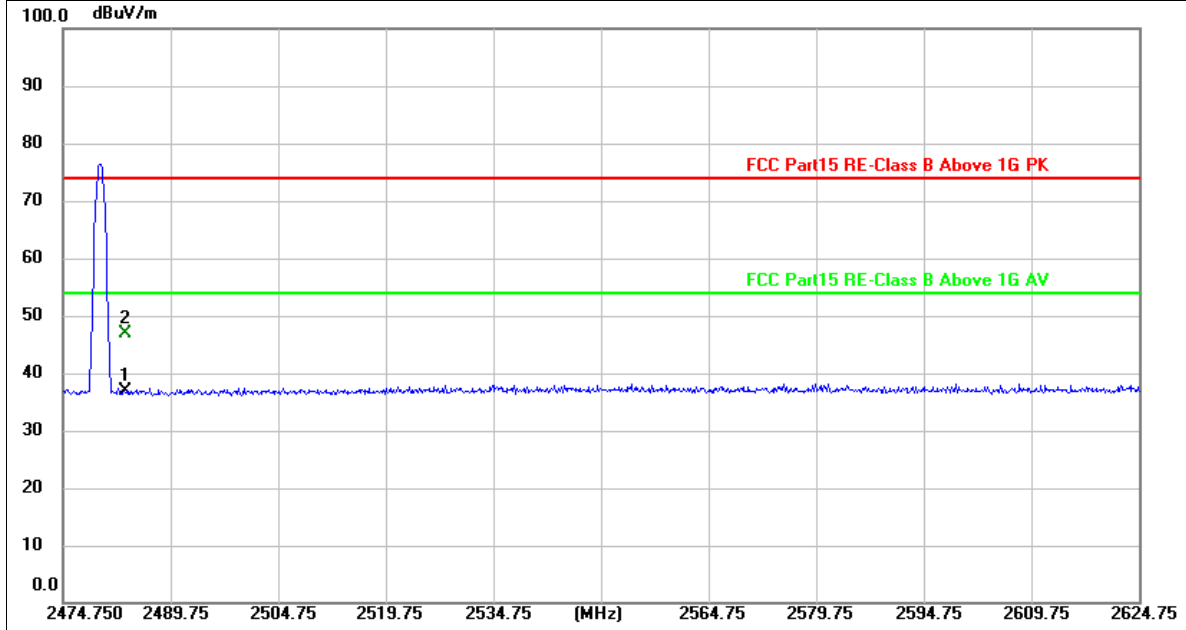

No.	Frequency (MHz)	Reading (dBuV)	Factor (dB/m)	Level (dBuV/m)	Limit (dBuV/m)	Margin (dB)	Detector
1	2483.500	5.71	31.24	36.95	74.00	-37.05	peak
2 *	2483.500	15.58	31.24	46.82	54.00	-7.18	AVG

Remarks:

1. Factor (dB/m) = Antenna Factor (dB/m)+Cable Factor (dB)-Pre-amplifier Factor
2. Margin value = Level -Limit value



Ant. Pol.	Horizontal
Test Mode:	$\pi/4$ -DQPSK Mode 2402MHz

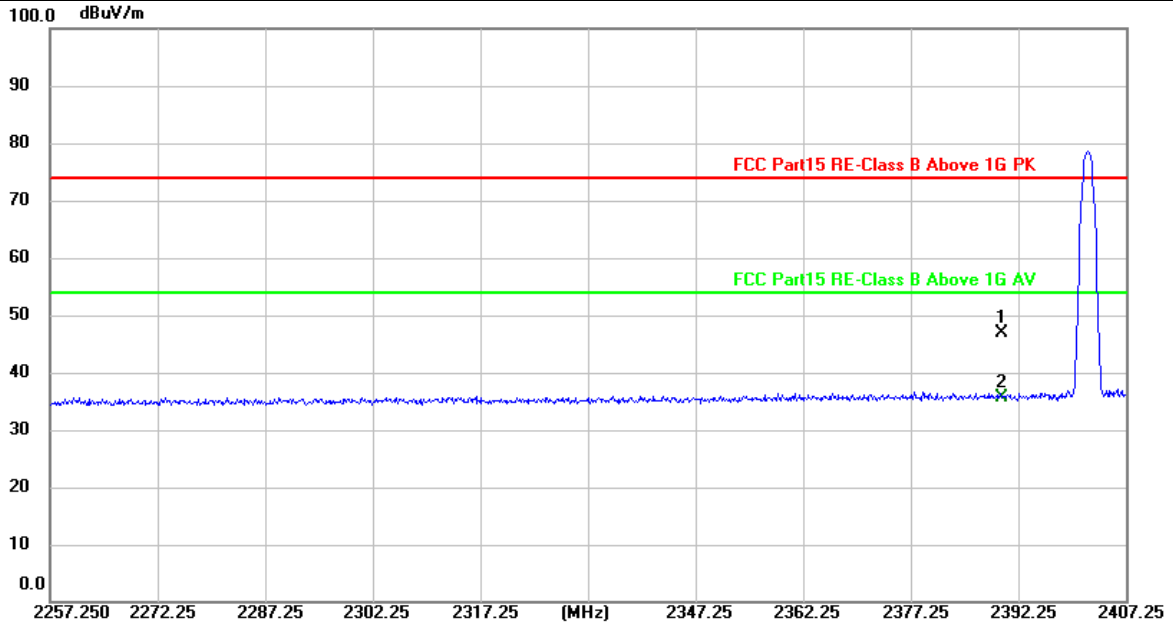

No.	Frequency (MHz)	Reading (dBuV)	Factor (dB/m)	Level (dBuV/m)	Limit (dBuV/m)	Margin (dB)	Detector
1	2390.000	16.16	30.84	47.00	74.00	-27.00	peak
2 *	2390.000	4.89	30.84	35.73	54.00	-18.27	AVG

Remarks:

- Factor (dB/m) = Antenna Factor (dB/m)+Cable Factor (dB)-Pre-amplifier Factor
- Margin value = Level -Limit value



Ant. Pol.	Vertical
Test Mode:	$\pi/4$ -DQPSK Mode 2402MHz

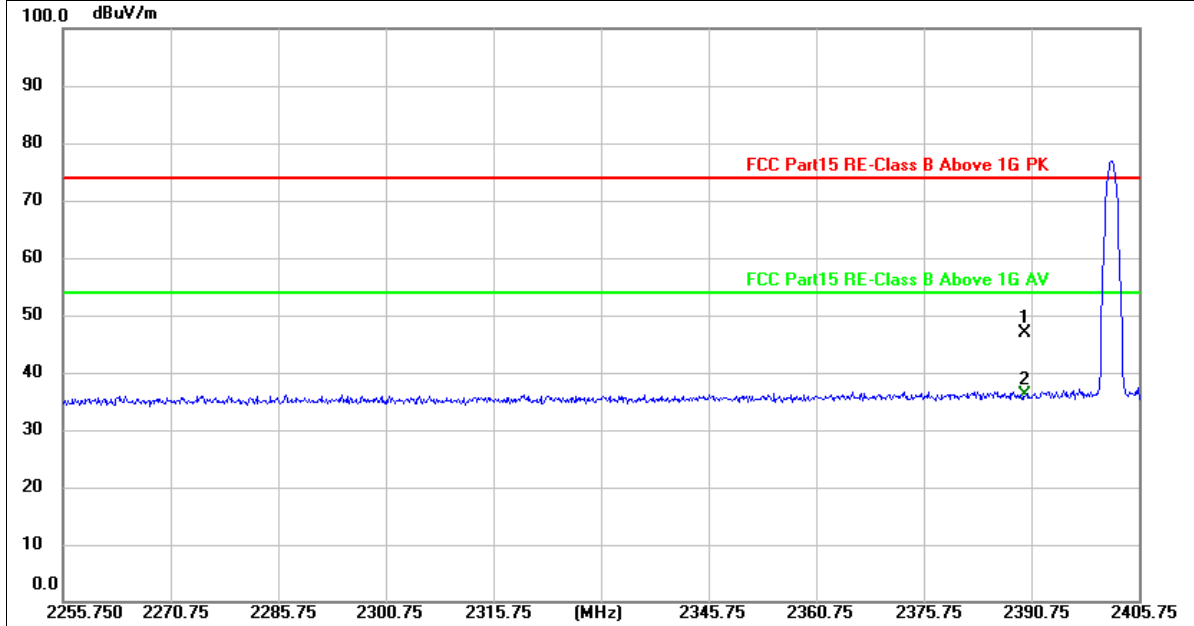

No.	Frequency (MHz)	Reading (dBuV)	Factor (dB/m)	Level (dBuV/m)	Limit (dBuV/m)	Margin (dB)	Detector
1	2390.000	16.13	30.84	46.97	74.00	-27.03	peak
2 *	2390.000	5.21	30.84	36.05	54.00	-17.95	AVG

Remarks:

- 1. Factor (dB/m) = Antenna Factor (dB/m)+Cable Factor (dB)-Pre-amplifier Factor
- 2. Margin value = Level -Limit value



Ant. Pol.	Horizontal
Test Mode:	$\pi/4$ -DQPSK Mode 2480MHz

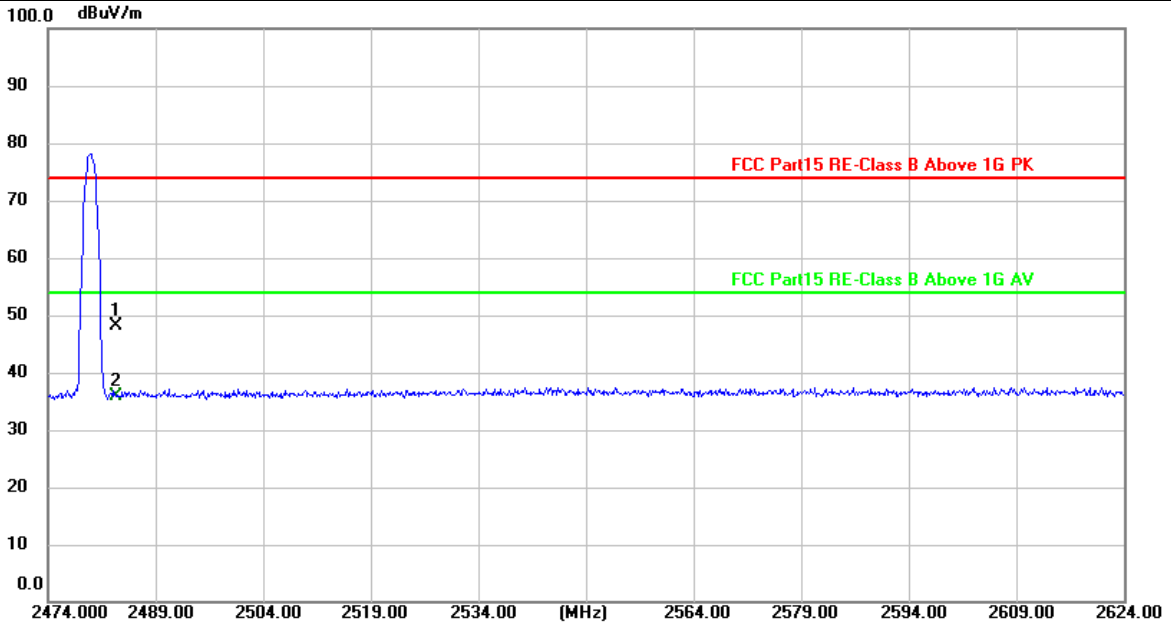

No.	Frequency (MHz)	Reading (dBuV)	Factor (dB/m)	Level (dBuV/m)	Limit (dBuV/m)	Margin (dB)	Detector
1	2483.500	16.81	31.24	48.05	74.00	-25.95	peak
2 *	2483.500	4.56	31.24	35.80	54.00	-18.20	AVG

Remarks:

- Factor (dB/m) = Antenna Factor (dB/m)+Cable Factor (dB)-Pre-amplifier Factor
- Margin value = Level -Limit value



Ant. Pol.	Vertical
Test Mode:	$\pi/4$ -DQPSK Mode 2480MHz

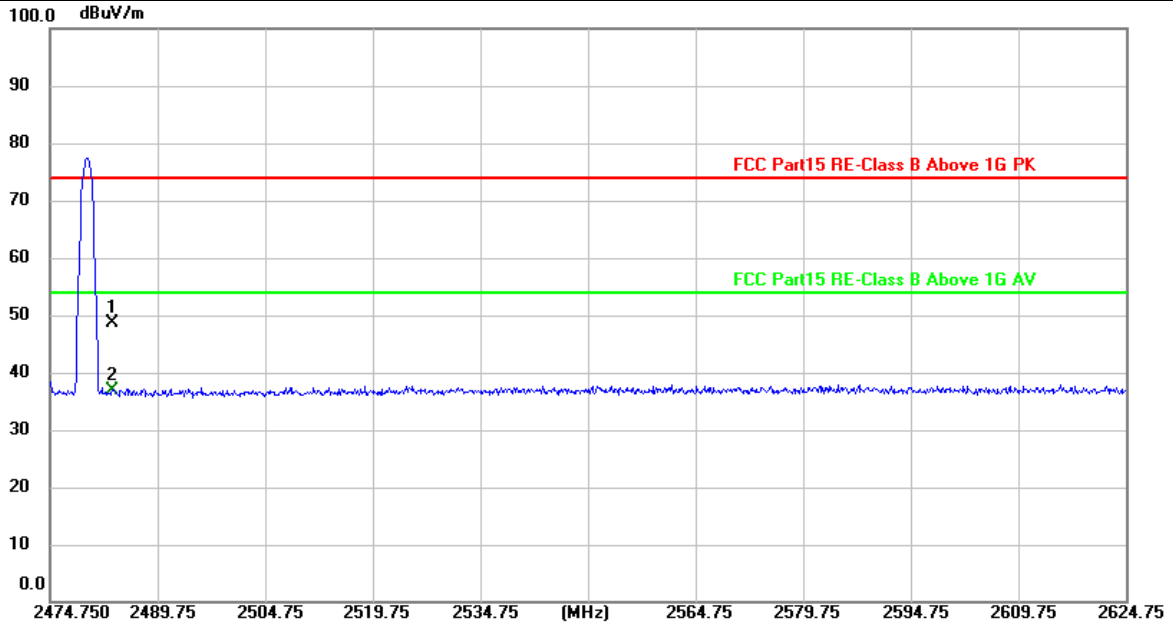

No.	Frequency (MHz)	Reading (dBuV)	Factor (dB/m)	Level (dBuV/m)	Limit (dBuV/m)	Margin (dB)	Detector
1	2483.500	17.36	31.24	48.60	74.00	-25.40	peak
2 *	2483.500	5.57	31.24	36.81	54.00	-17.19	AVG

Remarks:

- Factor (dB/m) = Antenna Factor (dB/m)+Cable Factor (dB)-Pre-amplifier Factor
- Margin value = Level -Limit value

3.4. Band edge and Spurious Emissions (Conducted)

Limit

FCC CFR Title 47 Part 15 Subpart C Section 15.247 (d): In any 100 kHz bandwidth outside the frequency band in which the spread spectrum intentional radiator is operating, the radio frequency power that is produced by the intentional radiator shall be at least 20 dB below that in the 100 kHz bandwidth within the band that contains the highest level of the desired power, based on either an RF conducted or a radiated measurement.

Test Configuration

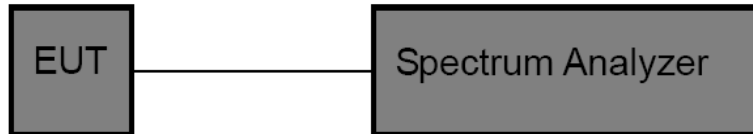

Test Procedure

1. The transmitter output was connected to the spectrum analyzer through an attenuator, the path loss was compensated to the results for each measurement.
2. Set to the maximum power setting and enable the EUT transmit continuously
3. Use the following spectrum analyzer settings:
RBW = 100 kHz, VBW ≥ RBW, scan up through 10th harmonic.
Sweep = auto, Detector function = peak, Trace = max hold
4. Measure and record the results in the test report.

Test Mode

Please refer to the clause 2.4.

Test Results

(1) Band edge Conducted Test

Test Mode	Antenna	ChName	Frequency (MHz)	RefLevel [dBm]	Result [dBm]	Limit [dBm]	Verdict
DH5	Ant1	Low	2402	-2.65	-48.31	≤-22.65	PASS
		High	2480	-3.63	-60.38	≤-23.63	PASS
		Low	Hop_2402	-3.12	-59.76	≤-23.12	PASS
		High	Hop_2480	-3.17	-59.82	≤-23.17	PASS
2DH5	Ant1	Low	2402	-2.62	-50.86	≤-22.62	PASS
		High	2480	-2.90	-55.67	≤-22.90	PASS
		Low	Hop_2402	-2.57	-59.32	≤-22.57	PASS
		High	Hop_2480	-2.89	-58.69	≤-22.89	PASS



Test plot as follows:

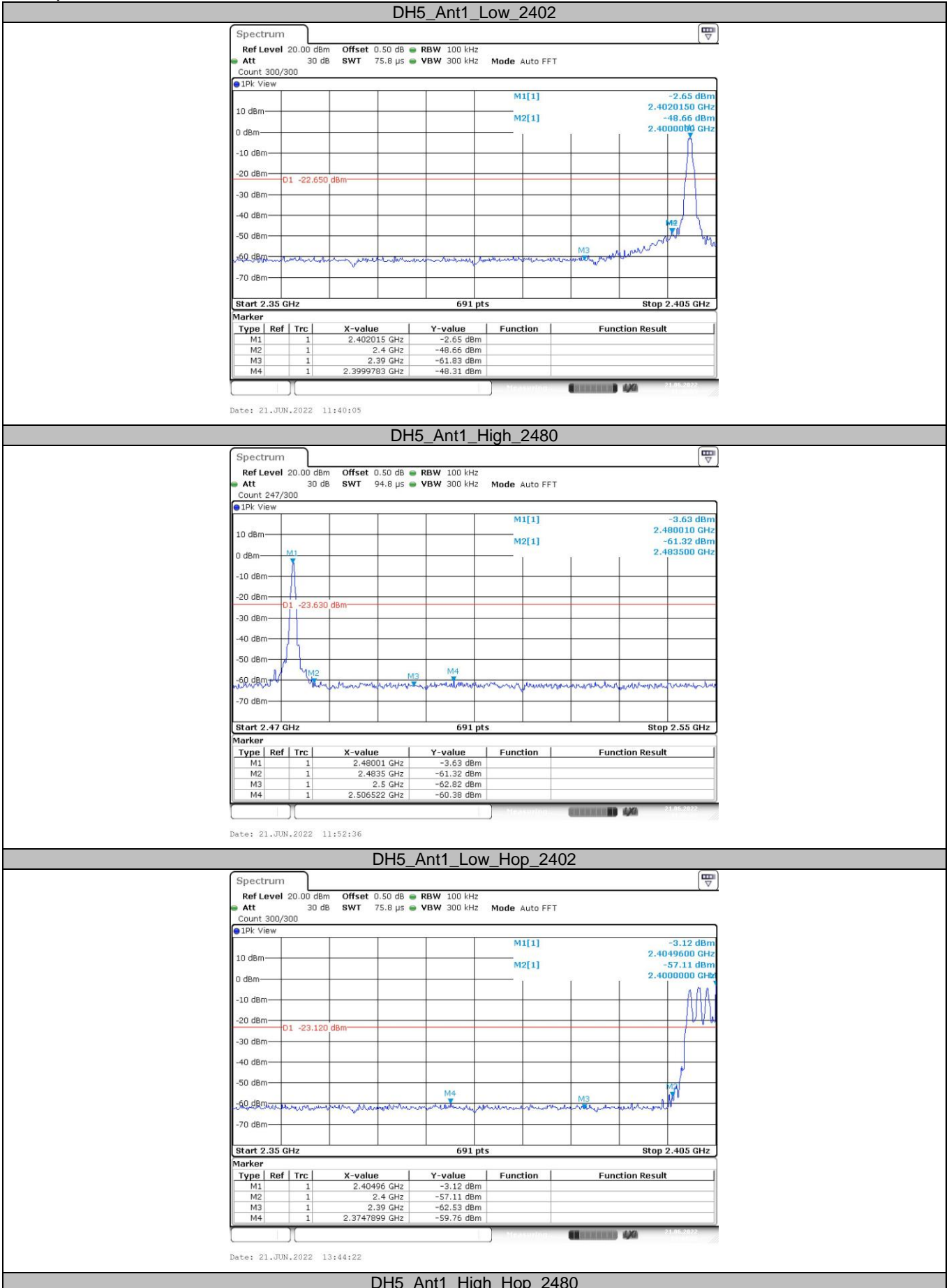

CTC Laboratories, Inc.

1-2/F., Building 2, Jiaquan Building, Guanlan High-Tech Park, Shenzhen, Guangdong, China
 Tel.: (86)755-27521059 Fax: (86)755-27521011 Http://www.sz-ctc.org.cn



For anti-fake verification, please visit the official website of Certification and Accreditation Administration of the People's Republic of China : yz.cnca.cn

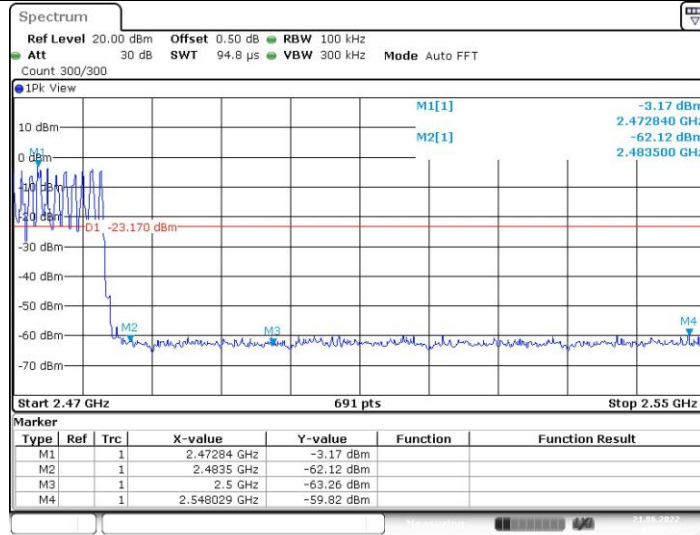

Date: 21.JUN.2022 13:53:21

2DH5_Ant1_Low_2402

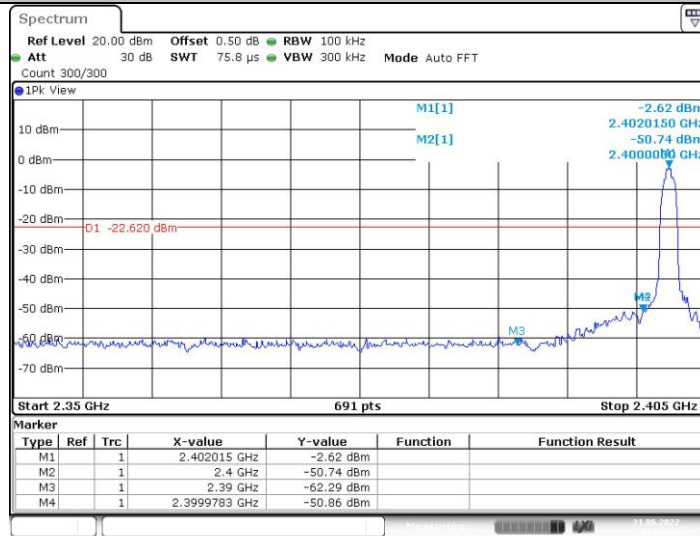

Date: 21.JUN.2022 11:57:07

2DH5_Ant1_High_2480

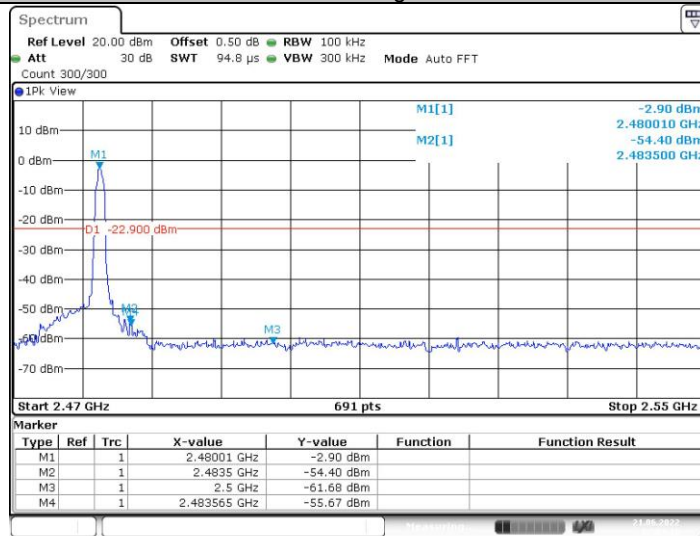

Date: 21.JUN.2022 12:03:10

2DH5_Ant1_Low_Hop_2402

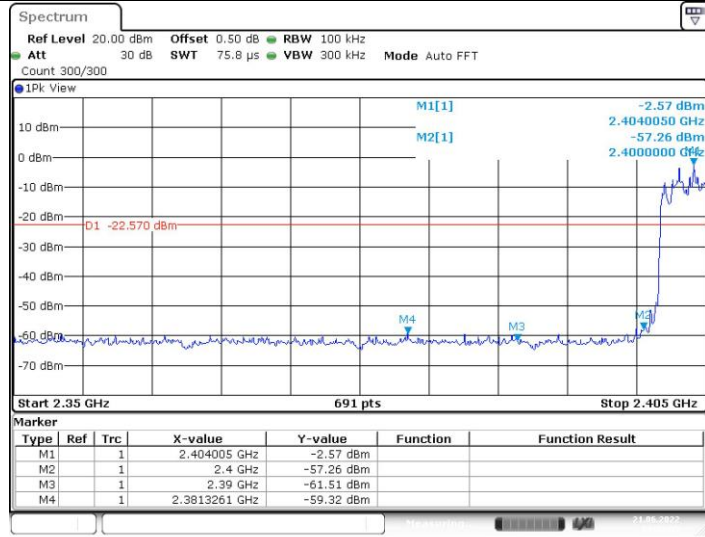

Date: 21.JUN.2022 13:53:55

2DH5_Ant1_High_Hop_2480

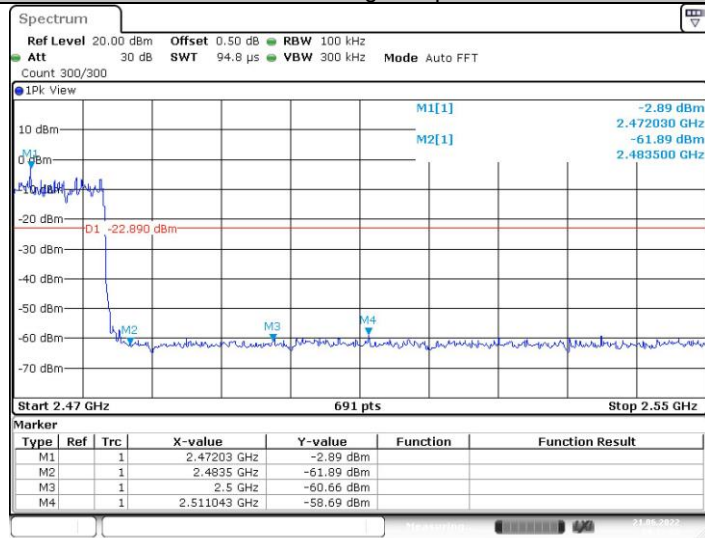

Date: 21.JUN.2022 14:12:10

**(2) Conducted Spurious Emissions Test**

Test Mode	Antenna	Frequency (MHz)	FreqRange [MHz]	RefLevel [dBm]	Result [dBm]	Limit [dBm]	Verdict
DH5	Ant1	2402	Reference	-2.60	-2.60	---	PASS
			30~1000	-2.60	-55.12	≤-22.60	PASS
			1000~26500	-2.60	-38.53	≤-22.60	PASS
		2441	Reference	-2.43	-2.43	---	PASS
			30~1000	-2.43	-54.51	≤-22.43	PASS
			1000~26500	-2.43	-37.94	≤-22.43	PASS
		2480	Reference	-2.70	-2.70	---	PASS
			30~1000	-2.70	-54.71	≤-22.70	PASS
			1000~26500	-2.70	-38.45	≤-22.70	PASS
2DH5	Ant1	2402	Reference	-2.61	-2.61	---	PASS
			30~1000	-2.61	-57.02	≤-22.61	PASS
			1000~26500	-2.61	-41.23	≤-22.61	PASS
		2441	Reference	-2.40	-2.40	---	PASS
			30~1000	-2.40	-54.61	≤-22.40	PASS
			1000~26500	-2.40	-38.60	≤-22.40	PASS
		2480	Reference	-2.65	-2.65	---	PASS
			30~1000	-2.65	-55.03	≤-22.65	PASS
			1000~26500	-2.65	-38.37	≤-22.65	PASS



Test plot as follows:

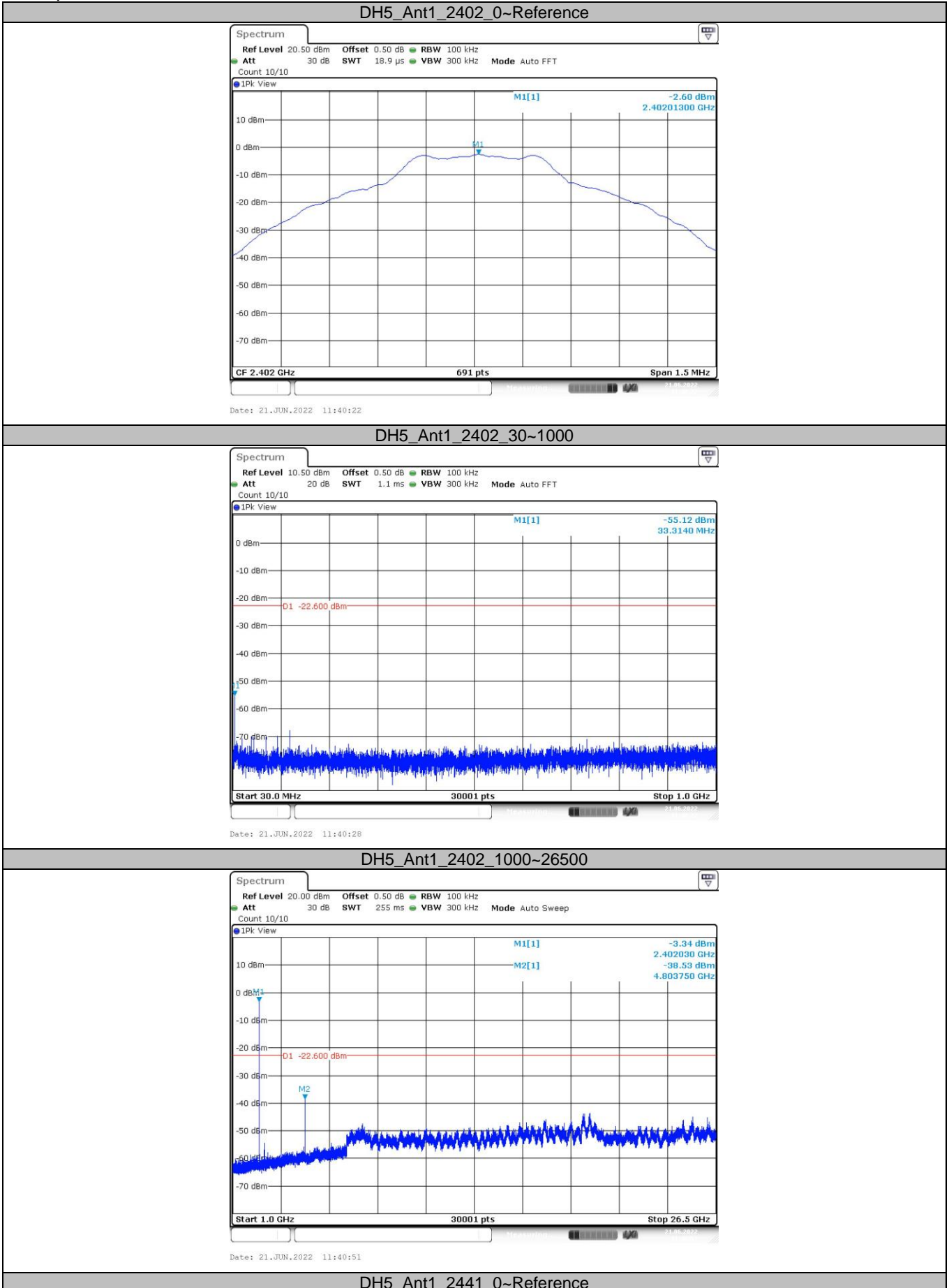

CTC Laboratories, Inc.

1-2/F., Building 2, Jiaquan Building, Guanlan High-Tech Park, Shenzhen, Guangdong, China
 Tel.: (86)755-27521059 Fax: (86)755-27521011 Http://www.sz-ctc.org.cn



For anti-fake verification, please visit the official website of Certification and Accreditation Administration of the People's Republic of China : yz.cnca.cn

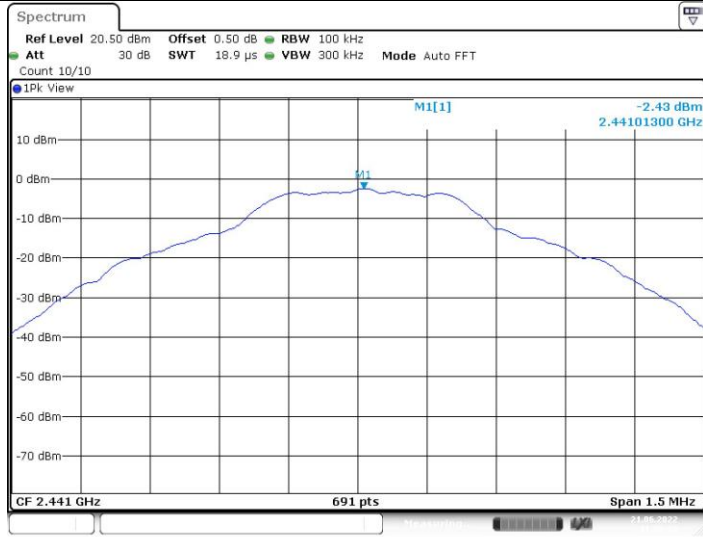

Date: 21.JUN.2022 11:50:40

DH5_Ant1_2441_30~1000

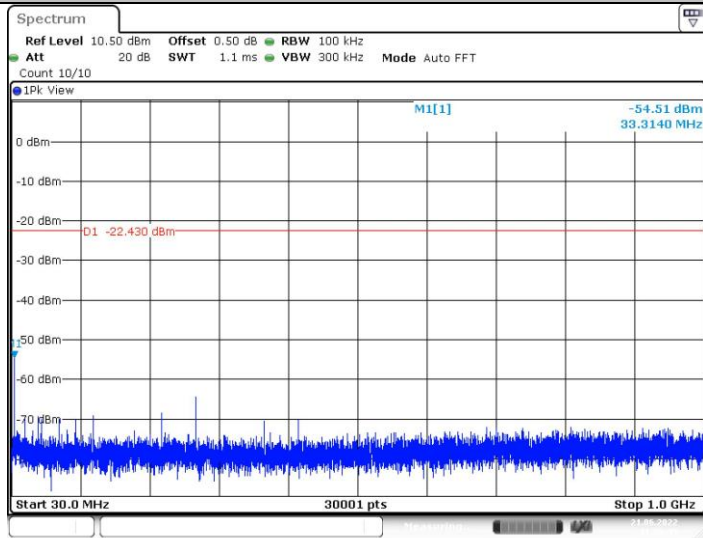

Date: 21.JUN.2022 11:50:45

DH5_Ant1_2441_1000~26500

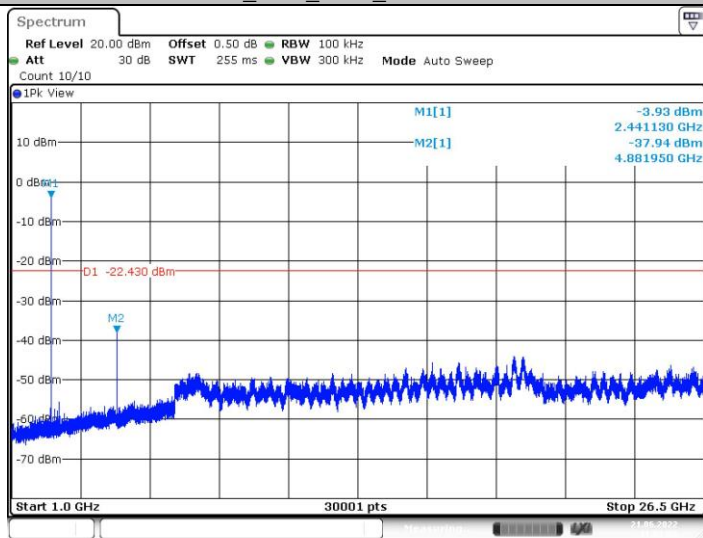

Date: 21.JUN.2022 11:51:09

DH5_Ant1_2480_0~Reference

CTC Laboratories, Inc.

1-2/F., Building 2, Jiaquan Building, Guanlan High-Tech Park, Shenzhen, Guangdong, China
 Tel.: (86)755-27521059 Fax: (86)755-27521011 Http://www.sz-ctc.org.cn



For anti-fake verification, please visit the official website of Certification and Accreditation Administration of the People's Republic of China : yz.cnca.cn



Date: 21.JUN.2022 11:53:23

DH5_Ant1_2480_30~1000

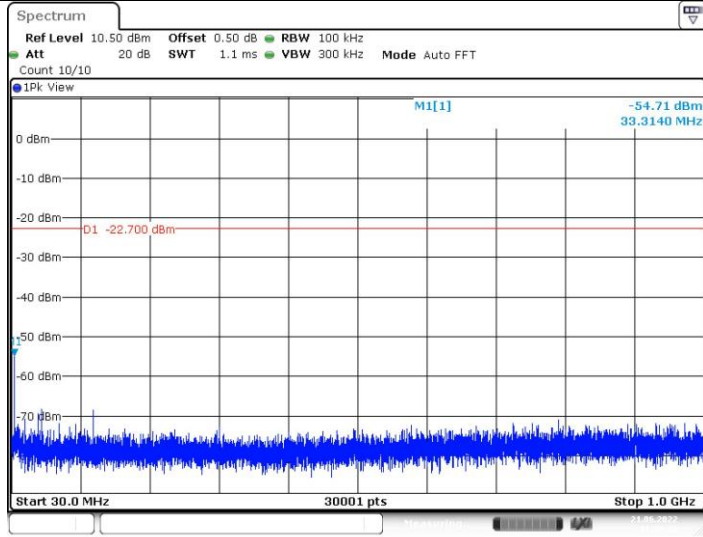

Date: 21.JUN.2022 11:53:29

DH5_Ant1_2480_1000~26500

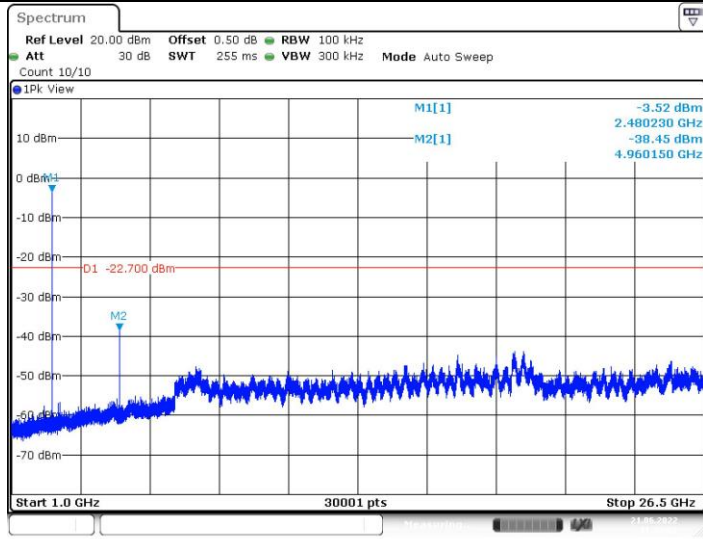

Date: 21.JUN.2022 11:53:52

2DH5_Ant1_2402_0~Reference

CTC Laboratories, Inc.

1-2/F., Building 2, Jiaquan Building, Guanlan High-Tech Park, Shenzhen, Guangdong, China
Tel.: (86)755-27521059

Fax: (86)755-27521011 Http://www.sz-ctc.org.cn
For anti-fake verification, please visit the official website of Certification and Accreditation Administration of the People's Republic of China : yz.cnca.cn



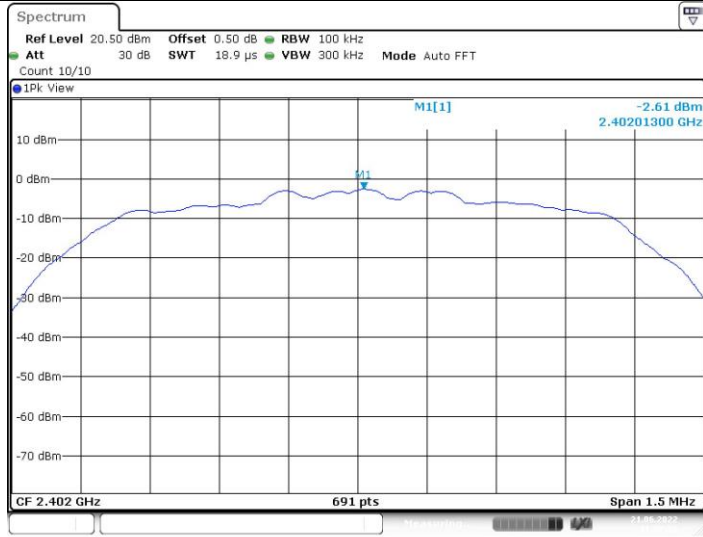

Date: 21.JUN.2022 11:57:23

2DH5_Ant1_2402_30~1000

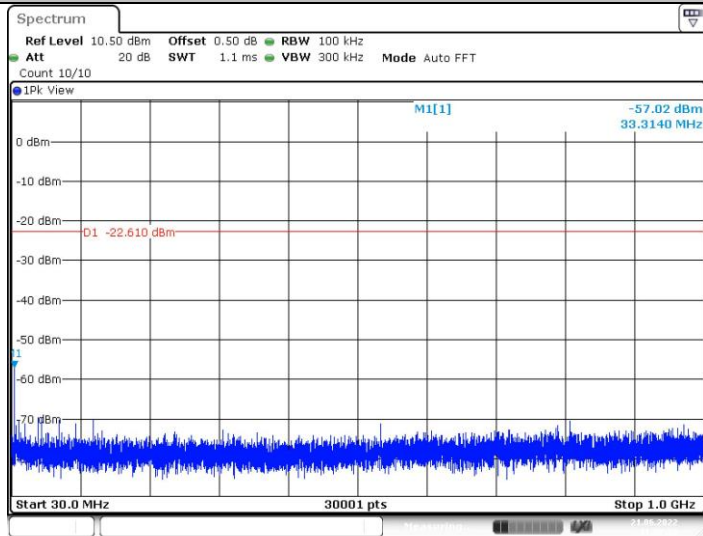

Date: 21.JUN.2022 11:57:29

2DH5_Ant1_2402_1000~26500

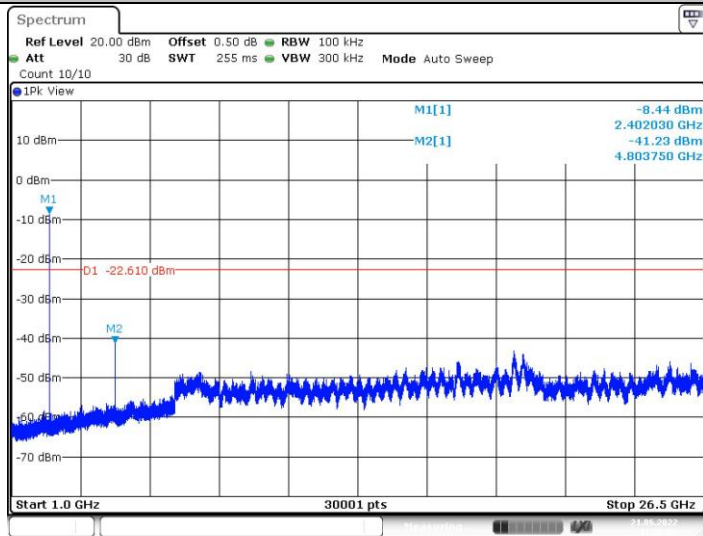

Date: 21.JUN.2022 11:57:52

2DH5_Ant1_2441_0~Reference

CTC Laboratories, Inc.

1-2/F., Building 2, Jiaquan Building, Guanlan High-Tech Park, Shenzhen, Guangdong, China
 Tel.: (86)755-27521059 Fax: (86)755-27521011 Http://www.sz-ctc.org.cn



For anti-fake verification, please visit the official website of Certification and Accreditation Administration of the People's Republic of China : yz.cnca.cn

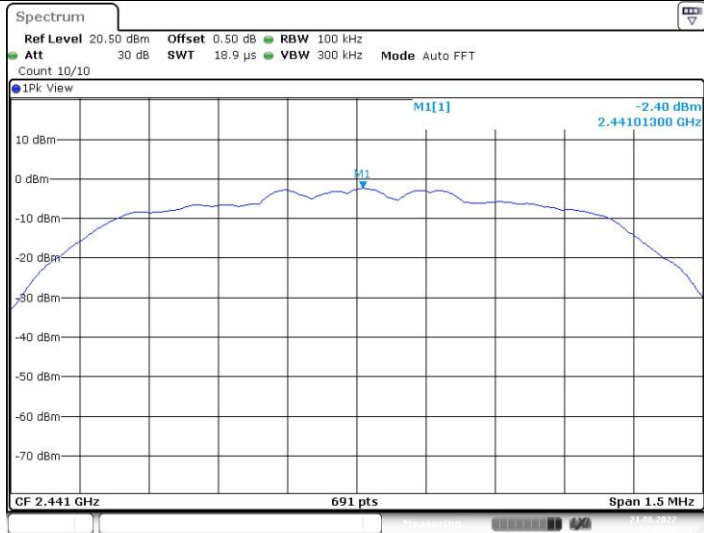

Date: 21.JUN.2022 12:00:27

2DH5_Ant1_2441_30~1000

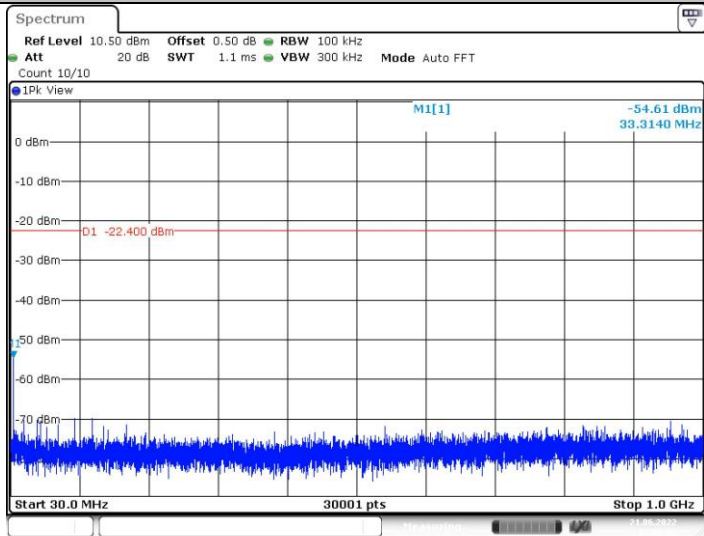

Date: 21.JUN.2022 12:00:32

2DH5_Ant1_2441_1000~26500

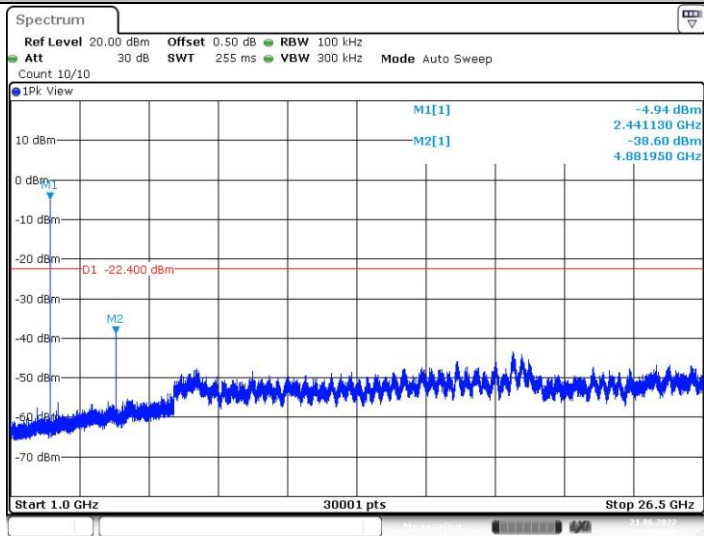

Date: 21.JUN.2022 12:00:56

2DH5_Ant1_2480_0~Reference

CTC Laboratories, Inc.

1-2/F., Building 2, Jiaquan Building, Guanlan High-Tech Park, Shenzhen, Guangdong, China
 Tel.: (86)755-27521059 Fax: (86)755-27521011 Http://www.sz-ctc.org.cn



For anti-fake verification, please visit the official website of Certification and Accreditation Administration of the People's Republic of China : yz.cnca.cn

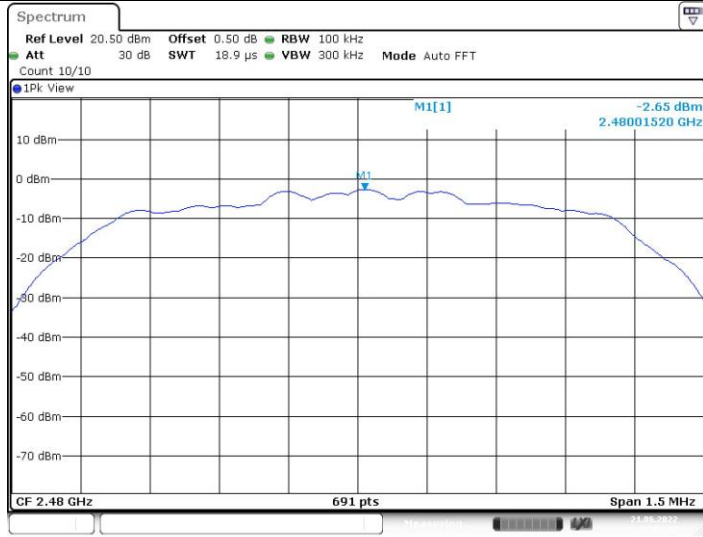

Date: 21.JUN.2022 12:03:27

2DH5_Ant1_2480_30~1000

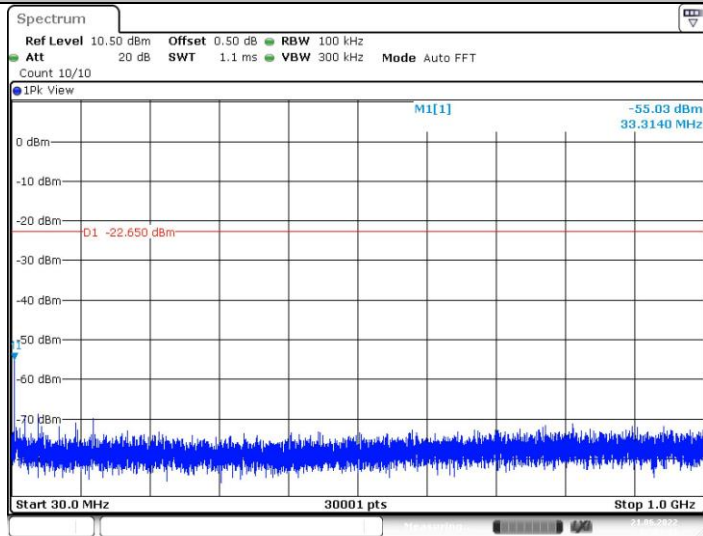

Date: 21.JUN.2022 12:03:32

2DH5_Ant1_2480_1000~26500

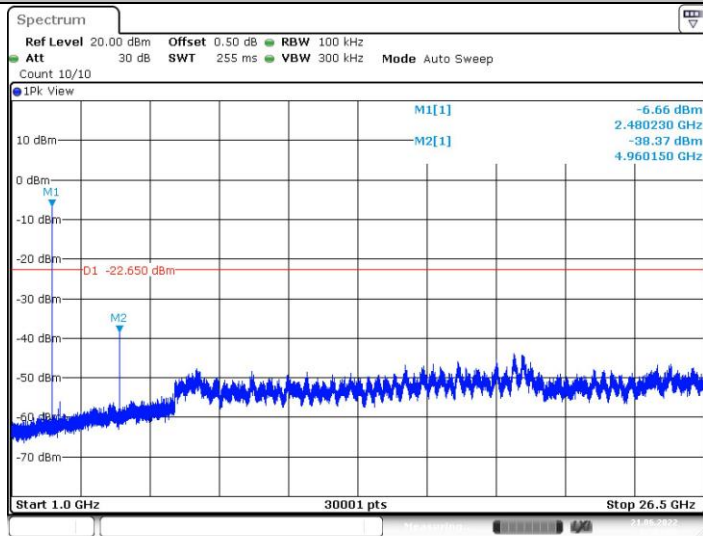

Date: 21.JUN.2022 12:03:56

CTC Laboratories, Inc.

1-2/F., Building 2, Jiaquan Building, Guanlan High-Tech Park, Shenzhen, Guangdong, China
 Tel.: (86)755-27521059 Fax: (86)755-27521011 Http://www.sz-ctc.org.cn



For anti-fake verification, please visit the official website of Certification and Accreditation Administration of the People's Republic of China : yz.cnca.cn

3.5. Bandwidth

Limit

N/A

Test Configuration

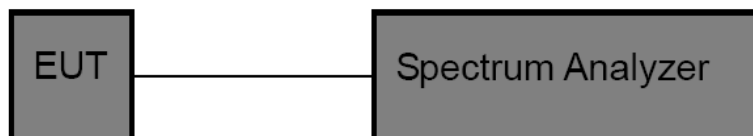

Test Procedure

1. The EUT was directly connected to the spectrum analyzer and antenna output port as show in the block diagram above.
2. OCB and 20dB Spectrum Setting:
 - (1) Set RBW = 1% ~ 5% occupied bandwidth.
 - (2) Set the video bandwidth (VBW) ≥ 3 RBW.
 - (3) Detector = Peak.
 - (4) Trace mode = Max hold.
 - (5) Sweep = Auto couple.

Note: The EUT was set to continuously transmitting in each mode and low, Middle and high channel for the test.

Test Mode

Please refer to the clause 2.4.

Test Results

Modulation type	Channel	Occupied Bandwidth (MHz)	20dB Bandwidth (MHz)	20dB Bandwidth *2/3 (MHz)
GFSK	00	0.833	1.077	0.718
	39	0.830	1.101	0.734
	78	0.839	1.083	0.722
π/4-DQPSK	00	1.160	1.374	0.916
	39	1.160	1.377	0.918
	78	1.160	1.377	0.918



Occupied Bandwidth:

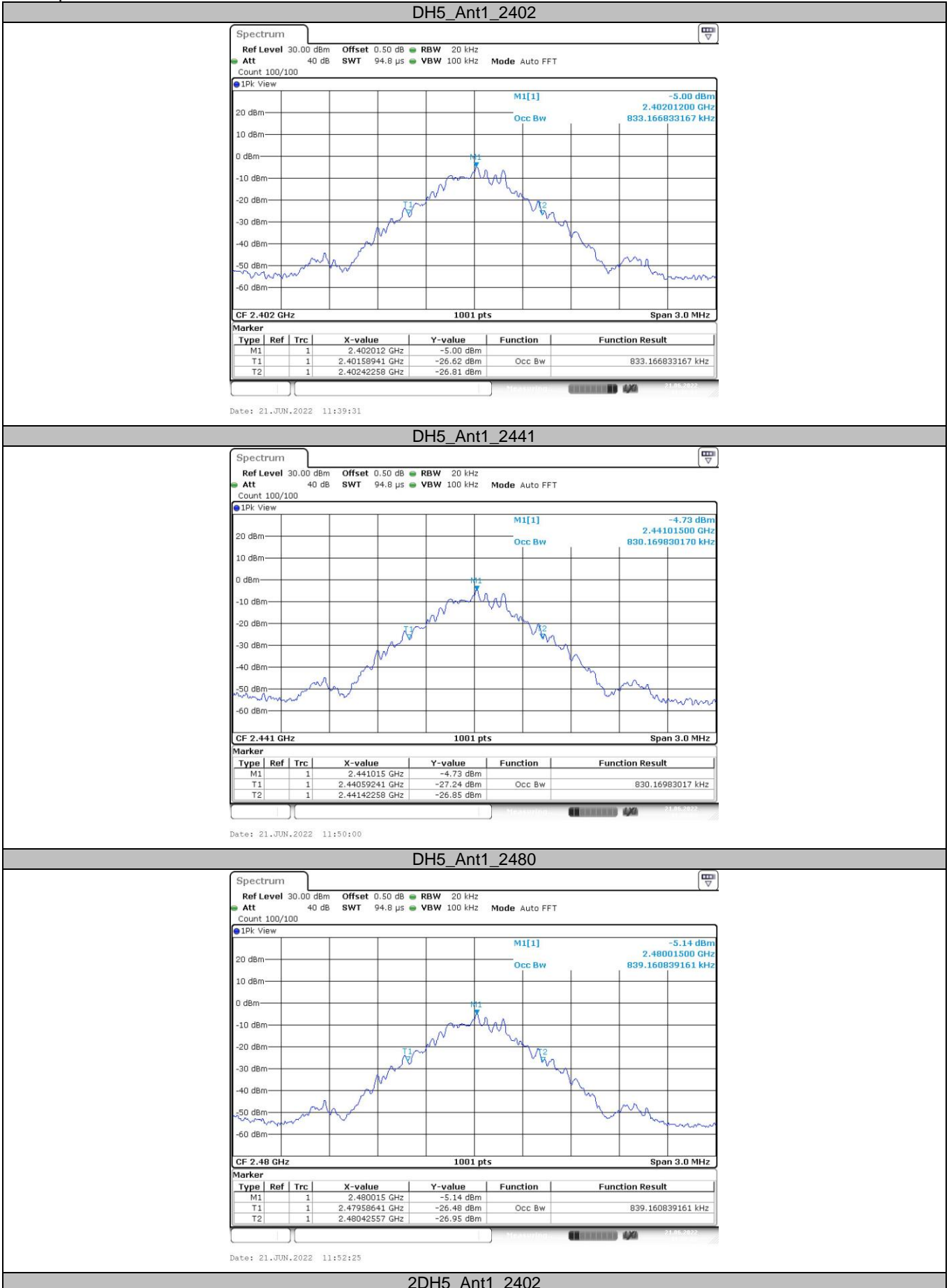

CTC Laboratories, Inc.

1-2/F., Building 2, Jiaquan Building, Guanlan High-Tech Park, Shenzhen, Guangdong, China
Tel.: (86)755-27521059 Fax: (86)755-27521011 Http://www.sz-ctc.org.cn



For anti-fake verification, please visit the official website of Certification and Accreditation Administration of the People's Republic of China : yz.cnca.cn



Date: 21.JUN.2022 11:56:45

2DH5_Ant1_2441



Date: 21.JUN.2022 12:00:10

2DH5_Ant1_2480



Date: 21.JUN.2022 12:02:53

CTC Laboratories, Inc.

1-2/F., Building 2, Jiaquan Building, Guanlan High-Tech Park, Shenzhen, Guangdong, China
 Tel.: (86)755-27521059 Fax: (86)755-27521011 Http://www.sz-ctc.org.cn



For anti-fake verification, please visit the official website of Certification and Accreditation Administration of the People's Republic of China : yz.cnca.cn



20dB Bandwidth:

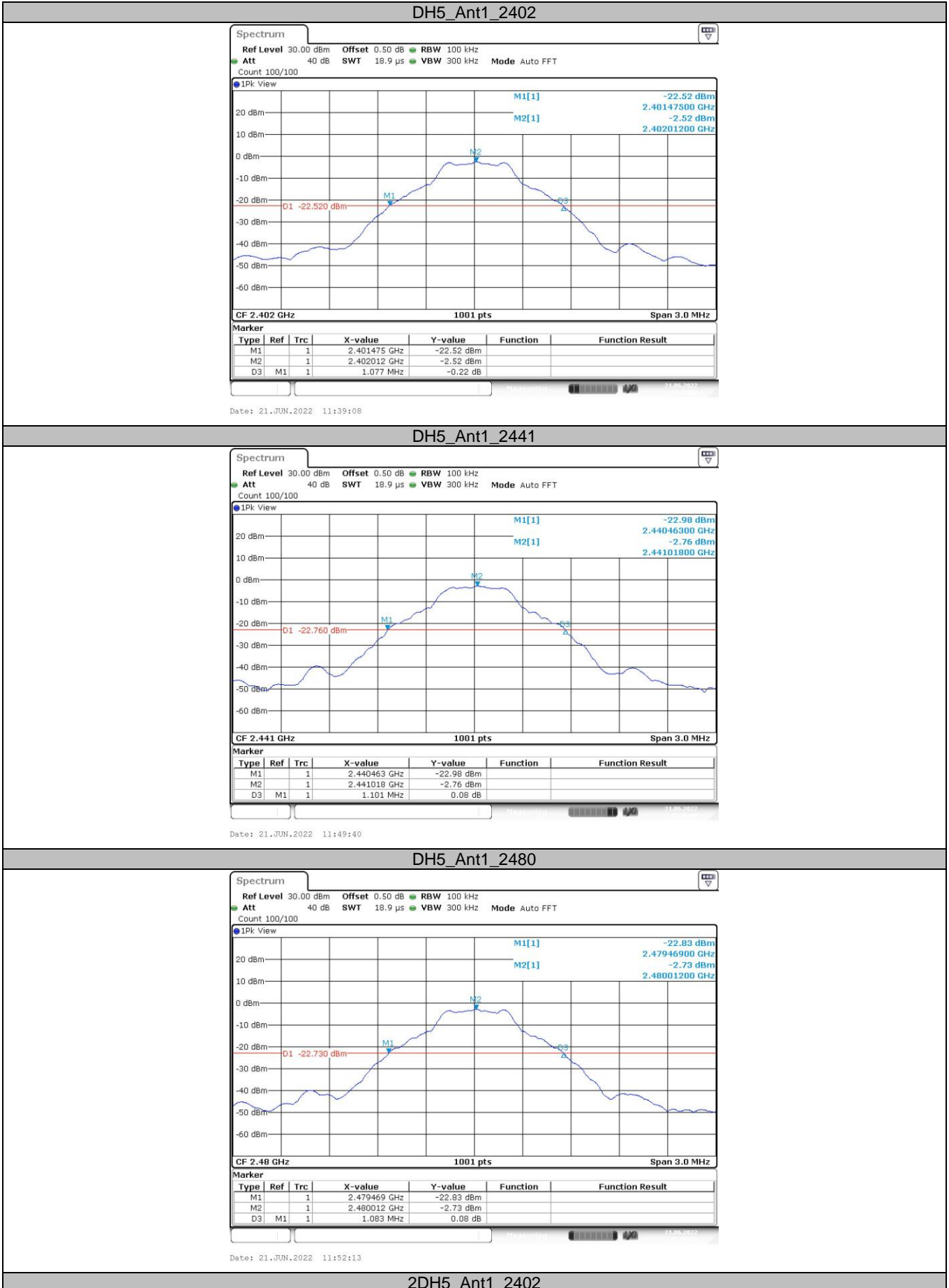

CTC Laboratories, Inc.

1-2/F., Building 2, Jiaquan Building, Guanlan High-Tech Park, Shenzhen, Guangdong, China
Tel.: (86)755-27521059 Fax: (86)755-27521011 Http://www.sz-ctc.org.cn



For anti-fake verification, please visit the official website of Certification and Accreditation Administration of the People's Republic of China : yz.cnca.cn

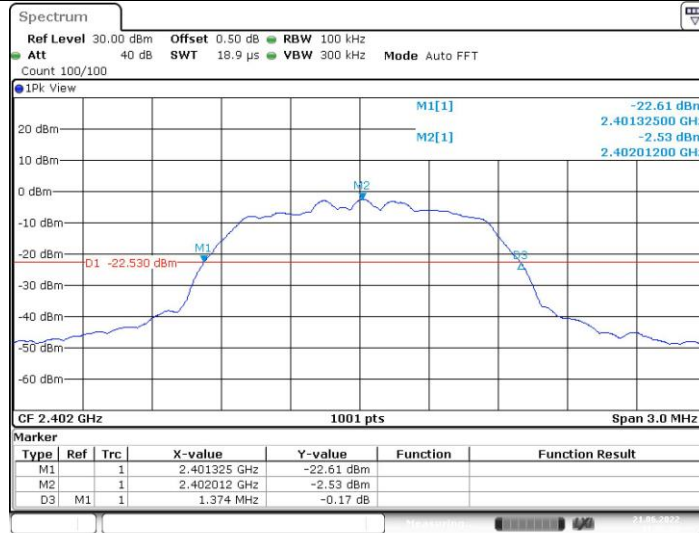

Date: 21.JUN.2022 11:56:28

2DH5_Ant1_2441

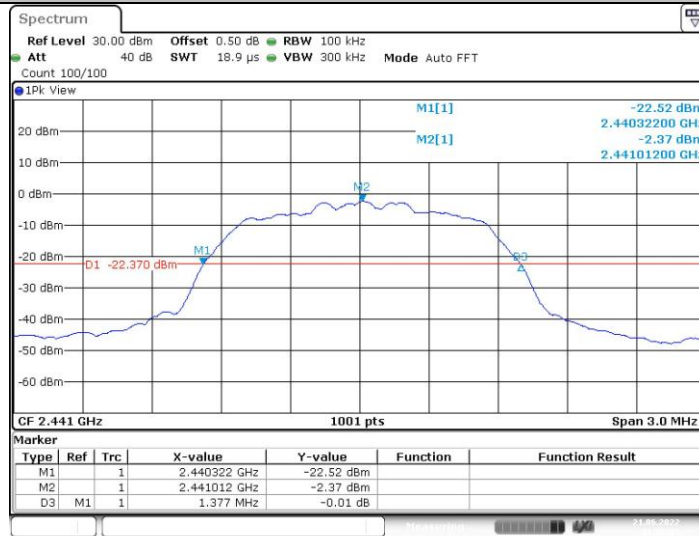

Date: 21.JUN.2022 11:59:52

2DH5_Ant1_2480

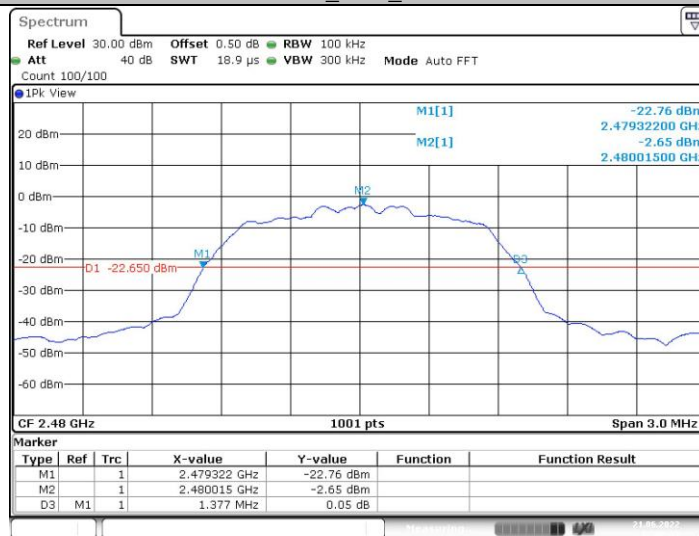

Date: 21.JUN.2022 12:02:35

CTC Laboratories, Inc.

1-2/F., Building 2, Jiaquan Building, Guanlan High-Tech Park, Shenzhen, Guangdong, China
Tel.: (86)755-27521059 Fax: (86)755-27521011 Http://www.sz-ctc.org.cn



For anti-fake verification, please visit the official website of Certification and Accreditation Administration of the People's Republic of China : yz.cnca.cn

3.6. Channel Separation

Limit

FCC CFR Title 47 Part 15 Subpart C Section 15.247 (a)(1)/ RSS-247 5.1 b :

Test Item	Limit	Frequency Range(MHz)
Channel Separation	>25KHz or >two-thirds of the 20 dB bandwidth Which is greater	2400~2483.5

Test Configuration

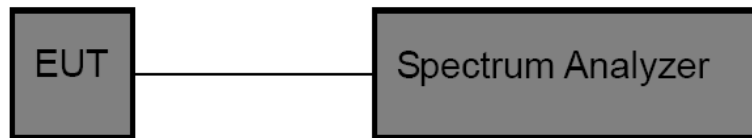

Test Procedure

1. The EUT was directly connected to the spectrum analyzer and antenna output port as show in the block diagram above.
2. Spectrum Setting:
 - (1) Set RBW = 100 kHz.
 - (2) Set the video bandwidth (VBW) ≥ 3 RBW.
 - (3) Detector = Peak.
 - (4) Trace mode = Max hold.
 - (5) Sweep = Auto couple.

Test Mode

Please refer to the clause 2.4.

Test Results

Modulation type	Channel	Carrier Frequencies Separation (MHz)	Limit (MHz)	Result
GFSK	39	0.994	0.734	Pass
π/4-DQPSK	39	1.003	0.918	Pass



Test plot as follows:





3.7. Number of Hopping Channel

Limit

FCC CFR Title 47 Part 15 Subpart C Section 15.247 (a)(iii)/ RSS-247 5.1 d:

Section	Test Item	Limit
15.247 (a)(iii)/ RSS-247 5.1 d:	Number of Hopping Channel	>15

Test Configuration

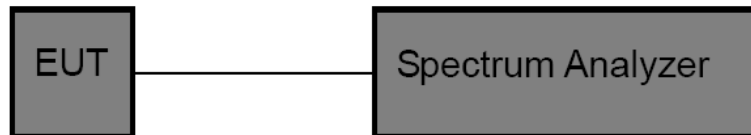

Test Procedure

- The EUT was directly connected to the spectrum analyzer and antenna output port as show in the block diagram above.
- Spectrum Setting:
 - Peak Detector: RBW=100 kHz, VBW≥RBW, Sweep time= Auto.

Test Mode

Please refer to the clause 2.4.

Test Result

Modulation type	Channel number	Limit	Result
GFSK	79	≥15.00	Pass
π/4-DQPSK	79		



Test plot as follows:

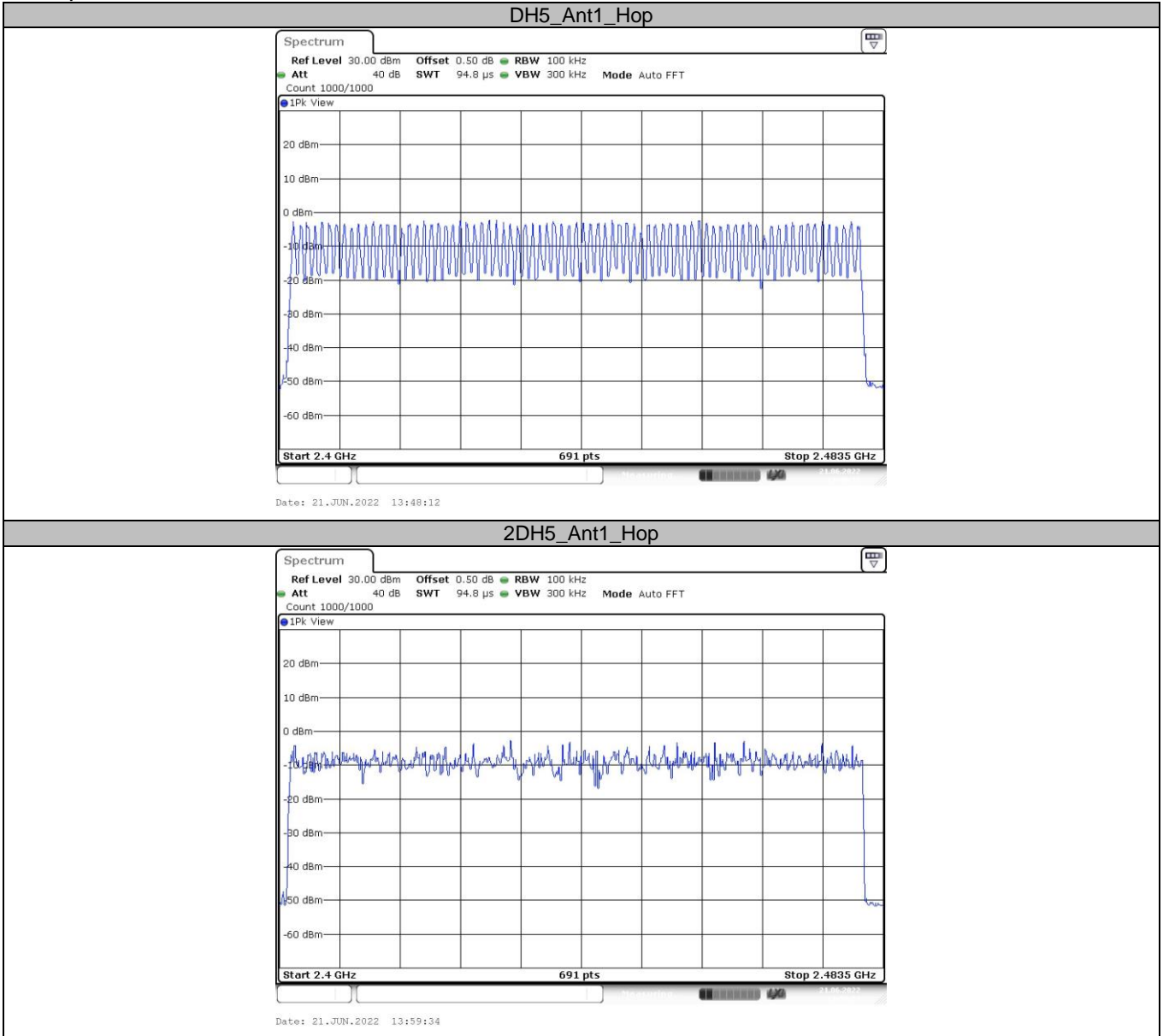

3.8. Dwell Time

Limit

Section	Test Item	Limit
15.247(a)(iii)/ RSS-247 5.1 d	Average Time of Occupancy	0.4 sec

Test Configuration

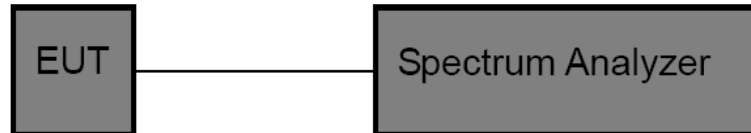

Test Procedure

1. The EUT was directly connected to the spectrum analyzer and antenna output port as show in the block diagram above.
2. Spectrum Setting:
 - (1) Spectrum Setting: RBW=1MHz, VBW≥RBW.
 - (2) Use video trigger with the trigger level set to enable triggering only on full pulses.
 - (3) Sweep Time is more than once pulse time.
 - (4) Set the center frequency on any frequency would be measure and set the frequency span to zero.
 - (5) Measure the maximum time duration of one single pulse.
 - (6) Set the EUT for packet transmitting.

Test Mode

Please refer to the clause 2.4.

**Test Result**

Modulation type	Channel	Channel (MHz)	Pulse Time (ms)	Total of Dwell (ms)	Period Time (ms)	Limit (Second)	Result
GFSK	DH1	2441	0.40	128.00	31.60	≤ 0.40	Pass
	DH3	2441	1.65	264.00	31.60		
	DH5	2441	2.90	309.33	31.60		
π/4-DQPSK	2DH1	2441	0.41	131.20	31.60	≤ 0.40	Pass
	2DH3	2441	2.90	464.00	31.60		
	2DH5	2441	2.90	309.33	31.60		

Note: 1DH1/2DH1/3DH1 Total of Dwell = Pulse Time*(1600/2)*31.6/79

1DH3/2DH3/3DH3 Total of Dwell = Pulse Time*(1600/4)*31.6/79

1DH5/2DH5/3DH5 Total of Dwell = Pulse Time*(1600/6)*31.6/79



Test plot as follows:

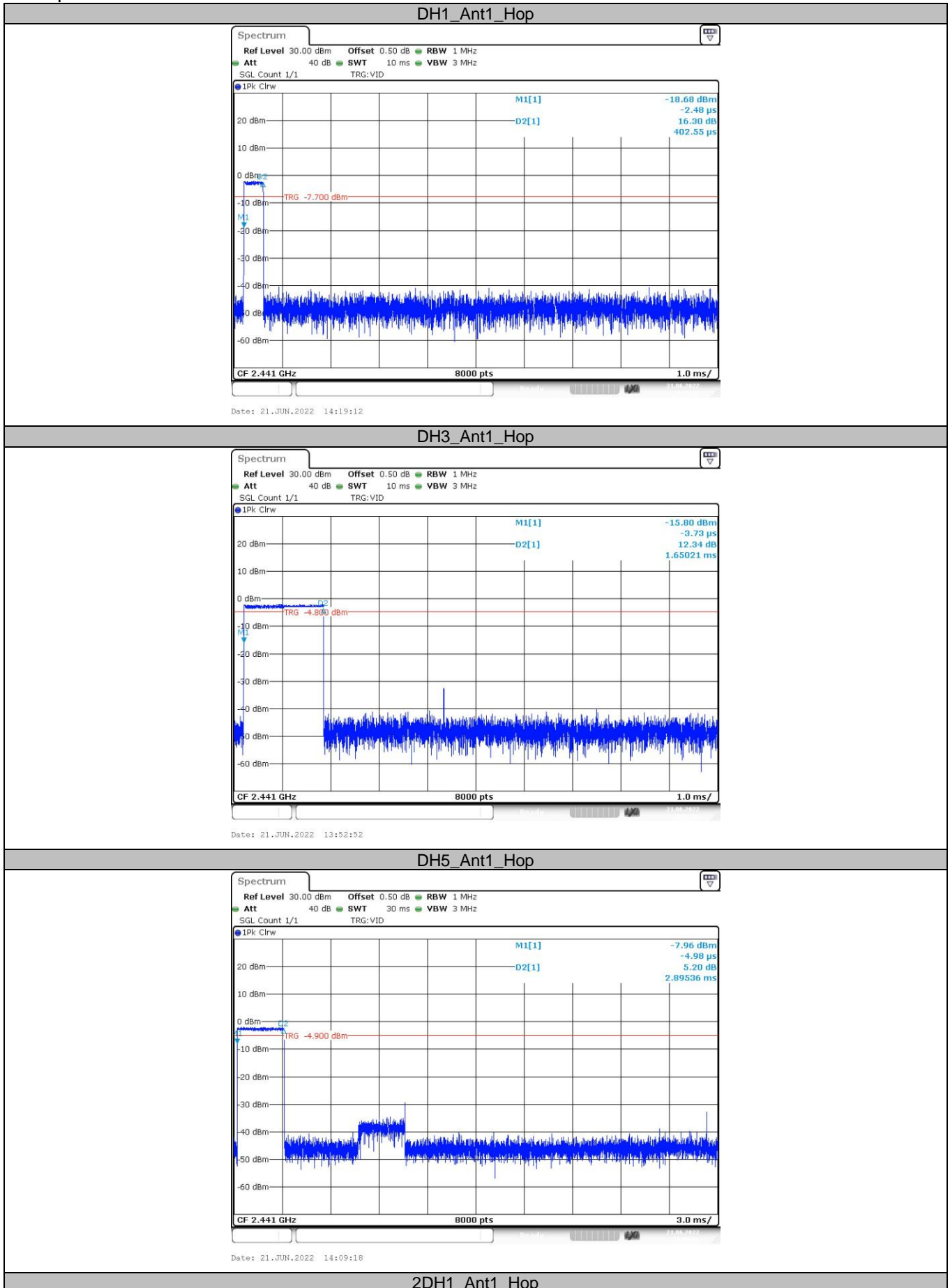

CTC Laboratories, Inc.

1-2/F., Building 2, Jiaquan Building, Guanlan High-Tech Park, Shenzhen, Guangdong, China
Tel.: (86)755-27521059 Fax: (86)755-27521011 Http://www.sz-ctc.org.cn



For anti-fake verification, please visit the official website of Certification and Accreditation Administration of the People's Republic of China : yz.cnca.cn

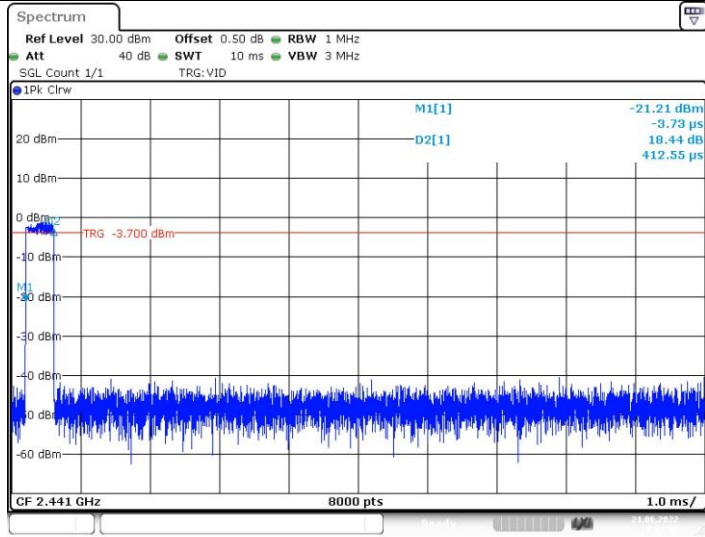

Date: 21.JUN.2022 14:02:30

2DH3_Ant1_Hop

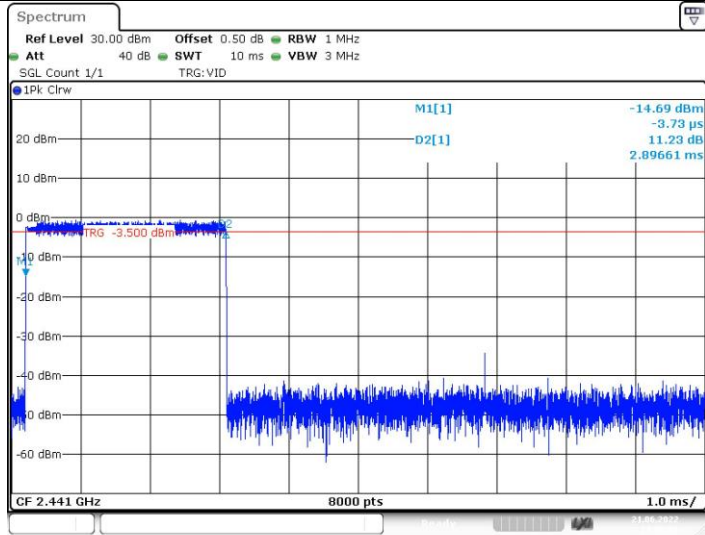

Date: 21.JUN.2022 14:06:06

2DH5_Ant1_Hop

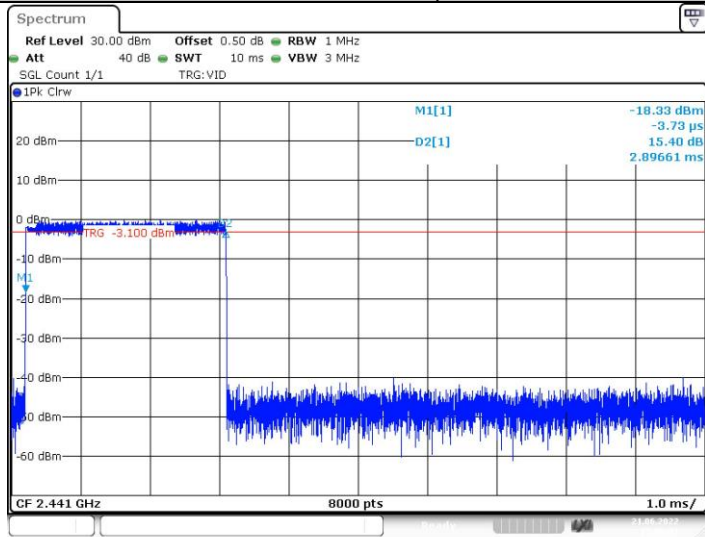

Date: 21.JUN.2022 15:06:31

CTC Laboratories, Inc.

1-2/F., Building 2, Jiaquan Building, Guanlan High-Tech Park, Shenzhen, Guangdong, China
 Tel.: (86)755-27521059 Fax: (86)755-27521011 Http://www.sz-ctc.org.cn



For anti-fake verification, please visit the official website of Certification and Accreditation Administration of the People's Republic of China : yz.cnca.cn

3.9. Peak Output Power

Limit

FCC CFR Title 47 Part 15 Subpart C Section 15.247 (b)(1) / RSS-247 5.4 b:

Test Item	Limit	Frequency Range(MHz)
Peak Output Power	Hopping Channels>75 Power<1W(30dBm) Other <125mW(21dBm)	2400~2483.5

Test Configuration

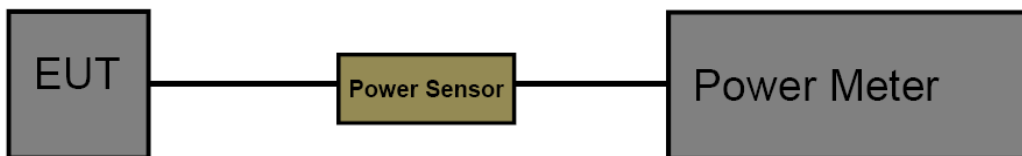

Test Procedure

1. The maximum conducted output power may be measured using a broadband Peak RF power meter.
2. Peak power measurements were performed only when the EUT was transmitting at its maximum power control level using a broadband power meter with a pulse sensor.
3. The power meter implemented triggering and gating capabilities which were set up such that power measurements were recorded only during the ON time of the transmitter.
4. Record the measurement data.

Test Mode

Please refer to the clause 2.4.

Test Result

Modulation type	Channel	Output power (dBm)	Limit (dBm)	Result
GFSK	00	-2.23	< 21.00	Pass
	39	-1.95		
	78	-2.40		
π/4-DQPSK	00	-0.97	< 21.00	Pass
	39	-0.51		
	78	-0.82		

3.10. Duty Cycle

Limit

None, for report purposes only.

Test Configuration

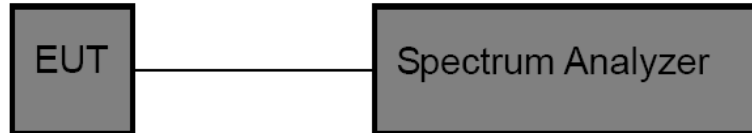

Test Procedure

1. The EUT was directly connected to the spectrum analyzer and antenna output port as show in the block diagram above.
2. The EUT was directly connected to the Spectrum Analyzer and antenna output port as show in the block diagram above. The measurement according to section 10.2 of KDB 558074 D01 DTS Meas Guidance v05r02.
3. Spectrum Setting:
 Set analyzer center frequency to test channel center frequency.
 Set the span to 0Hz
 Set the RBW to 10MHz
 Set the VBW to 10MHz
 Detector: Peak
 Sweep time: Auto
 Allow trace to fully stabilize. Then use the peak marker function to determine the maximum amplitude level.

Test Mode

Please refer to the clause 2.4.

Test Result

Test Mode	Frequency [MHz]	Transmission Duration [ms]	Transmission Period [ms]	Duty Cycle [%]	1/T Minimum VBW (kHz)	Final setting For VBW (kHz)
GFSK	2402	2.89	3.72	77.69	0.35	1
	2441	2.90	3.73	77.75	0.34	1
	2480	2.89	3.72	77.69	0.35	1
$\pi/4$ -DQPSK	2402	2.90	3.72	77.96	0.34	1
	2441	2.90	3.73	77.75	0.34	1
	2480	2.91	3.74	77.81	0.34	1



Test plot as follows:

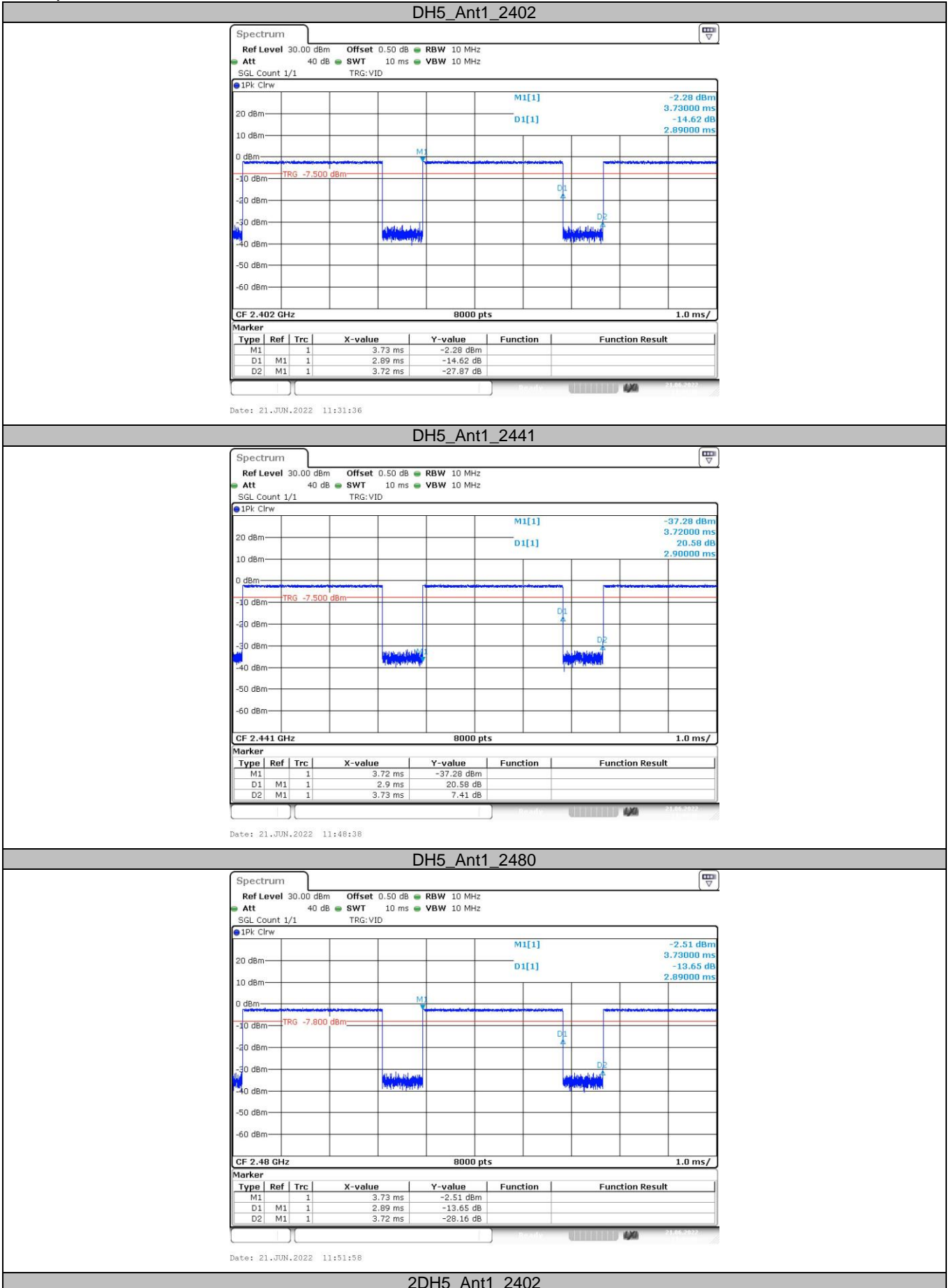

CTC Laboratories, Inc.

1-2/F., Building 2, Jiaquan Building, Guanlan High-Tech Park, Shenzhen, Guangdong, China
Tel.: (86)755-27521059 Fax: (86)755-27521011 Http://www.sz-ctc.org.cn



For anti-fake verification, please visit the official website of Certification and Accreditation Administration of the People's Republic of China : yz.cnca.cn

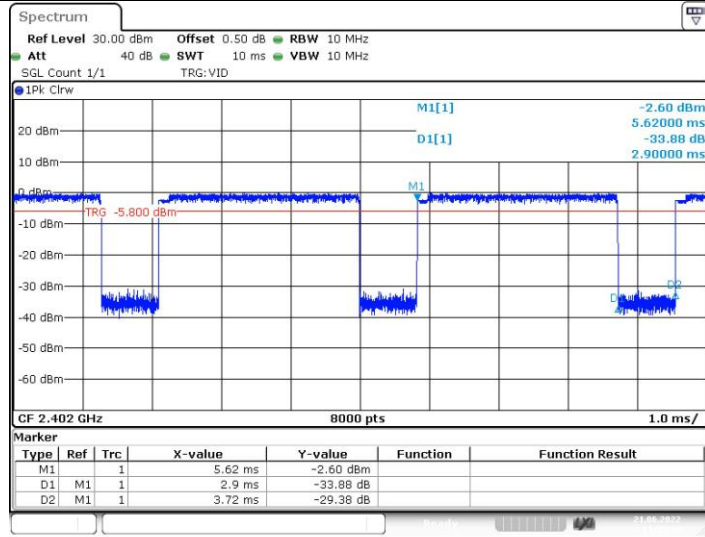

Date: 21.JUN.2022 11:55:24

2DH5_Ant1_2441

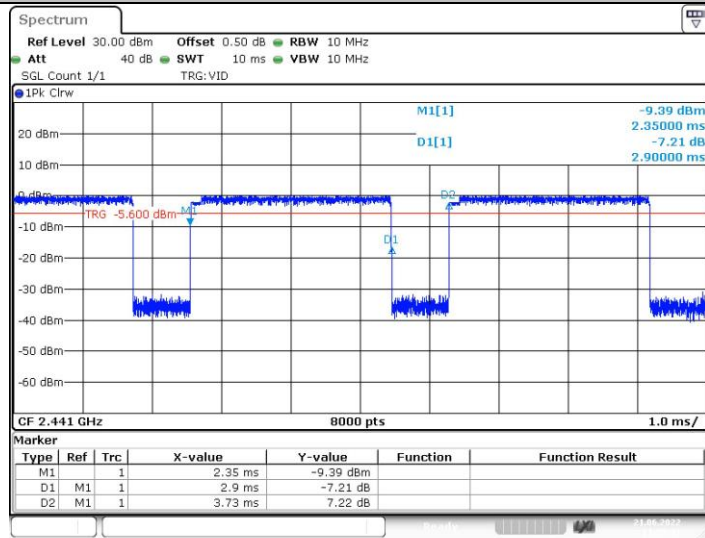

Date: 21.JUN.2022 11:59:31

2DH5_Ant1_2480

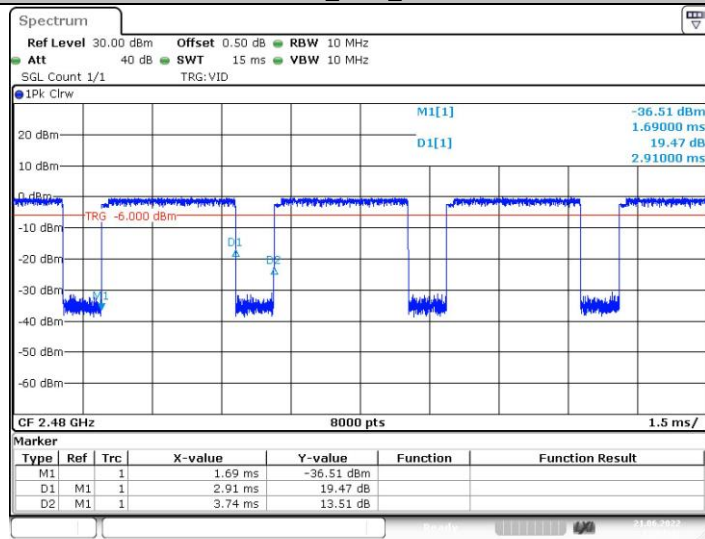

Date: 21.JUN.2022 12:01:42

CTC Laboratories, Inc.

1-2/F., Building 2, Jiaquan Building, Guanlan High-Tech Park, Shenzhen, Guangdong, China
Tel.: (86)755-27521059 Fax: (86)755-27521011 Http://www.sz-ctc.org.cn



For anti-fake verification, please visit the official website of Certification and Accreditation Administration of the People's Republic of China : yz.cnca.cn



3.11. Antenna Requirement

Requirement

FCC CFR Title 47 Part 15 Subpart C Section 15.203:

An intentional radiator shall be designed to ensure that no antenna other than that furnished by the responsible party shall be used with the device. The use of a permanently attached antenna or of antenna that uses a unique coupling to the intentional radiator, the manufacturer may design the unit so that a broken antenna can be replaced by the user, but the use of a standard antenna jack or electrical connector is prohibited.

FCC CFR Title 47 Part 15 Subpart C Section 15.247(c) (1)(i):

(i) Systems operating in the 2400~2483.5 MHz band that is used exclusively for fixed. Point-to-point operations may employ transmitting antennas with directional gain greater than 6dBi provided the maximum conducted output power of the intentional radiator is reduced by 1 dB for every 3 dB that the directional gain of the antenna exceeds 6dBi.

Test Result

The directional gain of the antenna less than 6dBi, please refer to the EUT internal photographs antenna photo.

*****THE END*****