FCC Test Report

Report No.: AGC11758240547FR02

FCC ID : 2A482-S0TV00
APPLICATION PURPOSE : Original Equipment
PRODUCT DESIGNATION : Baseus Security P1 Lite Indoor Camera 2K
BRAND NAME : baseus
MODEL NAME : S0TV00
APPLICANT : Shenzhen Baseus Technology Co., Ltd.
DATE OF ISSUE : Jun. 03, 2024
STANDARD(S) : FCC Part 15 Subpart C §15.247
REPORT VERSION : V1.0

Attestation of Global Compliance (Shenzhen) Co., Ltd



Any report having not been signed by authorized approver, or having been altered without authorization, or having not been stamped by the "Dedicated Testing/Inspection Stamp" is deemed to be invalid. Copying or excerpting portion of, or altering the content of the report is not permitted without the written authorization of AGC. The test results presented in the report apply only to the tested sample. Any objections to report issued by AGC should be submitted to AGC within 15days after the issuance of the test report. Further enquiry of validity or verification of the test report should be addressed to AGC by agc01@agccert.com.

Attestation of Global Compliance(Shenzhen)Co., Ltd
Attestation of Global Compliance(Shenzhen)Std & Tech Co., Ltd
Tel: +86-755 2523 4088 E-mail: agc@agccert.com Web: <http://www.agccert.com/>



Report Revise Record

| Report Version | Revise Time | Issued Date | Valid Version | Notes |
|----------------|-------------|---------------|---------------|-----------------|
| V1.0 | / | Jun. 03, 2024 | Valid | Initial Release |

Any report having not been signed by authorized approver, or having been altered without authorization, or having not been stamped by the "Dedicated Testing/Inspection Stamp" is deemed to be invalid. Copying or excerpting portion of, or altering the content of the report is not permitted without the written authorization of AGC. The test results presented in the report apply only to the tested sample. Any objections to report issued by AGC should be submitted to AGC within 15days after the issuance of the test report. Further enquiry of validity or verification of the test report should be addressed to AGC by agc01@agccert.com.

Attestation of Global Compliance(Shenzhen)Co., Ltd
Attestation of Global Compliance(Shenzhen)Std & Tech Co., Ltd
Tel: +86-755 2523 4088 E-mail: agc@agccert.com Web: <http://www.agccert.com/>

Table of Contents

| | |
|--|-----------|
| 1. General Information | 5 |
| 2. Product Information | 6 |
| 2.1 Product Technical Description | 6 |
| 2.2 Table of Carrier Frequency | 7 |
| 2.3 IEEE 802.11n Modulation Scheme | 8 |
| 2.4 Related Submittal(S) / Grant (S) | 9 |
| 2.5 Test Methodology | 9 |
| 2.6 Special Accessories | 9 |
| 2.7 Equipment Modifications | 9 |
| 2.8 Antenna Requirement..... | 9 |
| 2.9 Description of Test Software | 10 |
| 3. Test Environment | 11 |
| 3.1 Address of The Test Laboratory | 11 |
| 3.2 Test Facility | 11 |
| 3.3 Environmental Conditions | 12 |
| 3.4 Measurement Uncertainty | 12 |
| 3.5 List of Equipment Used | 13 |
| 4. System Test Configuration..... | 15 |
| 4.1 EUT Configuration | 15 |
| 4.2 EUT Exercise..... | 15 |
| 4.3 Configuration of Tested System | 15 |
| 4.4 Equipment Used in Tested System | 15 |
| 4.5 Summary of Test Results | 16 |
| 5. Description of Test Modes | 17 |
| 6. Duty Cycle Measurement | 18 |
| 7. RF Output Power Measurement | 20 |
| 7.1 Provisions Applicable | 20 |
| 7.2 Measurement Procedure..... | 20 |
| 7.3 Measurement Setup (Block Diagram of Configuration) | 20 |
| 7.4 Measurement Result | 21 |
| 8. 6dB Bandwidth Measurement..... | 22 |
| 8.1 Provisions Applicable | 22 |
| 8.2 Measurement Procedure..... | 22 |
| 8.3 Measurement Setup (Block Diagram of Configuration) | 22 |
| 8.4 Measurement Result | 23 |

Any report having not been signed by authorized approver, or having been altered without authorization, or having not been stamped by the “Dedicated Testing/Inspection Stamp” is deemed to be invalid. Copying or excerpting portion of, or altering the content of the report is not permitted without the written authorization of AGC. The test results presented in the report apply only to the tested sample. Any objections to report issued by AGC should be submitted to AGC within 15days after the issuance of the test report. Further enquiry of validity or verification of the test report should be addressed to AGC by agc01@agccert.com.

| | |
|--|-----------|
| 9. Power Spectral Density Measurement..... | 34 |
| 9.1 Provisions Applicable | 34 |
| 9.2 Measurement Procedure..... | 34 |
| 9.3 Measurement Setup (Block Diagram of Configuration) | 35 |
| 9.4 Measurement Result | 35 |
| 10. Conducted Band Edge and Out-of-Band Emissions..... | 41 |
| 10.1 Provisions Applicable | 41 |
| 10.2 Measurement Procedure..... | 41 |
| 10.3 Measurement Setup (Block Diagram of Configuration) | 41 |
| 10.4 Measurement Result | 42 |
| 11. Radiated Spurious Emission | 53 |
| 11.1 Measurement Limits | 53 |
| 11.2 Measurement Procedure | 53 |
| 11.3 Measurement Setup (Block Diagram of Configuration) | 56 |
| 11.4 Measurement Result | 57 |
| 12. AC Power Line Conducted Emission..... | 80 |
| 12.1 Measurement Limits | 80 |
| 12.2 Block Diagram of Line Conducted Emission Test..... | 80 |
| 12.3 Preliminary Procedure of Line Conducted Emission Test | 81 |
| 12.4 Final Procedure of Line Conducted Emission Test | 81 |
| 12.5 Test Result of Line Conducted Emission Test..... | 81 |
| Appendix I: Photographs of Test Setup..... | 84 |
| Appendix II: Photographs of Test EUT | 84 |

Any report having not been signed by authorized approver, or having been altered without authorization, or having not been stamped by the “Dedicated Testing/Inspection Stamp” is deemed to be invalid. Copying or excerpting portion of, or altering the content of the report is not permitted without the written authorization of AGC. The test results presented in the report apply only to the tested sample. Any objections to report issued by AGC should be submitted to AGC within 15days after the issuance of the test report. Further enquiry of validity or verification of the test report should be addressed to AGC by agc01@agccert.com.

1. General Information

| | |
|------------------------------|---|
| Applicant | Shenzhen Baseus Technology Co., Ltd. |
| Address | 2nd Floor, Building B, Baseus Intelligence Park, No.2008, Xuegang Rd, Gangtou Community, Bantian Street, Longgang District, Shenzhen, China |
| Manufacturer | Shenzhen Baseus Technology Co., Ltd. |
| Address | 2nd Floor, Building B, Baseus Intelligence Park, No.2008, Xuegang Rd, Gangtou Community, Bantian Street, Longgang District, Shenzhen, China |
| Factory | N/A |
| Address | N/A |
| Product Designation | Baseus Security P1 Lite Indoor Camera 2K |
| Brand Name | baseus |
| Test Model | S0TV00 |
| Series Model(s) | N/A |
| Difference Description | N/A |
| Date of receipt of test item | May 20, 2024 |
| Date of Test | May 20, 2024 to Jun. 03, 2024 |
| Deviation from Standard | No any deviation from the test method |
| Condition of Test Sample | Normal |
| Test Result | Pass |
| Test Report Form No | AGCER-FCC-2.4GWLAN-V1 |

Note: The test results of this report relate only to the tested sample identified in this report.

| | | |
|-------------|---|---------------|
| Prepared By |  | |
| | Jack Gui (Project Engineer) | Jun. 03, 2024 |
| Reviewed By |  | |
| | Calvin Liu (Reviewer) | Jun. 03, 2024 |
| Approved By |  | |
| | Max Zhang (Authorized Officer) | Jun. 03, 2024 |

Any report having not been signed by authorized approver, or having been altered without authorization, or having not been stamped by the “Dedicated Testing/Inspection Stamp” is deemed to be invalid. Copying or excerpting portion of, or altering the content of the report is not permitted without the written authorization of AGC. The test results presented in the report apply only to the tested sample. Any objections to report issued by AGC should be submitted to AGC within 15days after the issuance of the test report. Further enquiry of validity or verification of the test report should be addressed to AGC by agc01@agccert.com.

2. Product Information

2.1 Product Technical Description

| | |
|------------------------|---|
| Equipment Type | WLAN 2.4G |
| Frequency Band | 2400MHz ~ 2483.5MHz |
| Operation Frequency | 2412MHz ~ 2462MHz |
| Output Power (Average) | IEEE 802.11b: 14.48dBm; IEEE 802.11g: 13.35dBm; IEEE 802.11n(HT20): 12.49dBm |
| Output Power (Peak) | IEEE 802.11b: 17.62dBm; IEEE 802.11g: 21.07dBm; IEEE 802.11n(HT20): 20.21dBm |
| Modulation | 802.11b:(DQPSK, DBPSK, CCK) DSSS 802.11g/n:(64-QAM,16-QAM, QPSK, BPSK) OFDM |
| Data Rate | 802.11b:1/2/5.5/11Mbps 802.11g: 6/9/12/18/24/36/48/54Mbps 802.11n: up to 72.2Mbps |
| Number of channels | 11 |
| Hardware Version | V1.0 |
| Software Version | V1.0 |
| Antenna Designation | PCB Antenna |
| Antenna Gain | 1.42dBi |
| Power Supply | DC 5V by adapter |

Any report having not been signed by authorized approver, or having been altered without authorization, or having not been stamped by the "Dedicated Testing/Inspection Stamp" is deemed to be invalid. Copying or excerpting portion of, or altering the content of the report is not permitted without the written authorization of AGC. The test results presented in the report apply only to the tested sample. Any objections to report issued by AGC should be submitted to AGC within 15days after the issuance of the test report. Further enquiry of validity or verification of the test report should be addressed to AGC by agc01@agccert.com.

2.2 Table of Carrier Frequency

For 2412-2462MHz:

11 channels are provided for 802.11b/g/n(HT20):

| Channel | Frequency | Channel | Frequency | Channel | Frequency |
|---------|-----------|---------|-----------|---------|-----------|
| 01 | 2412 MHz | 02 | 2417 MHz | 03 | 2422 MHz |
| 04 | 2427 MHz | 05 | 2432 MHz | 06 | 2437 MHz |
| 07 | 2442 MHz | 08 | 2447 MHz | 09 | 2452 MHz |
| 10 | 2457 MHz | 11 | 2462 MHz | | |

Any report having not been signed by authorized approver, or having been altered without authorization, or having not been stamped by the "Dedicated Testing/Inspection Stamp" is deemed to be invalid. Copying or excerpting portion of, or altering the content of the report is not permitted without the written authorization of AGC. The test results presented in the report apply only to the tested sample. Any objections to report issued by AGC should be submitted to AGC within 15days after the issuance of the test report. Further enquiry of validity or verification of the test report should be addressed to AGC by agc01@agccert.com.

2.3 IEEE 802.11n Modulation Scheme

| MCS Index | N _{ss} | Modulation | R | N _{BPSC} | N _{CBPS} | | N _{DBPS} | | Data Rate(Mbps) | |
|-----------|-----------------|------------|-----|-------------------|-------------------|-------|-------------------|-------|-----------------|-------|
| | | | | | 20MHz | 40MHz | 20MHz | 40MHz | 800nsGI | |
| | | | | | | | | | 20MHz | 40MHz |
| 0 | 1 | BPSK | 1/2 | 1 | 52 | 108 | 26 | 54 | 6.5 | 13.5 |
| 1 | 1 | QPSK | 1/2 | 2 | 104 | 216 | 52 | 108 | 13.0 | 27.0 |
| 2 | 1 | QPSK | 3/4 | 2 | 104 | 216 | 78 | 162 | 19.5 | 40.5 |
| 3 | 1 | 16-QAM | 1/2 | 4 | 208 | 432 | 104 | 216 | 26.0 | 54.0 |
| 4 | 1 | 16-QAM | 3/4 | 4 | 208 | 432 | 156 | 324 | 39.0 | 81.0 |
| 5 | 1 | 64-QAM | 2/3 | 6 | 312 | 648 | 208 | 432 | 52.0 | 108.0 |
| 6 | 1 | 64-QAM | 3/4 | 6 | 312 | 648 | 234 | 489 | 58.5 | 121.5 |
| 7 | 1 | 64-QAM | 5/6 | 6 | 312 | 648 | 260 | 540 | 65.0 | 135.0 |

| Symbol | Explanation |
|--------|---|
| NSS | Number of spatial streams |
| R | Code rate |
| NBPSC | Number of coded bits per single carrier |
| NCBPS | Number of coded bits per symbol |
| NDBPS | Number of data bits per symbol |
| GI | Guard interval |

Any report having not been signed by authorized approver, or having been altered without authorization, or having not been stamped by the "Dedicated Testing/Inspection Stamp" is deemed to be invalid. Copying or excerpting portion of, or altering the content of the report is not permitted without the written authorization of AGC. The test results presented in the report apply only to the tested sample. Any objections to report issued by AGC should be submitted to AGC within 15days after the issuance of the test report. Further enquiry of validity or verification of the test report should be addressed to AGC by agc01@agccert.com.

2.4 Related Submittal(S) / Grant (S)

This submittal(s) (test report) is intended for FCC ID: 2A482-S0TV00, filing to comply with Part 2, Part 15 of the Federal Communication Commission rules.

2.5 Test Methodology

The tests were performed according to following standards:

| No. | Identity | Document Title |
|-----|--------------------|---|
| 1 | FCC 47 CFR Part 2 | Frequency allocations and radio treaty matters; general rules and regulations |
| 2 | FCC 47 CFR Part 15 | Radio Frequency Devices |
| 3 | ANSI C63.10-2013 | American National Standard for Testing Unlicensed Wireless Devices |

2.6 Special Accessories

Refer to section 4.4.

2.7 Equipment Modifications

Not available for this EUT intended for grant.

2.8 Antenna Requirement

| Standard Requirement |
|---|
| <p>15.203 requirement: An intentional radiator shall be designed to ensure that no antenna other than that furnished by the responsible party shall be used with the device. The use of a permanently attached antenna or of an antenna that uses a unique coupling to the intentional radiator, the manufacturer may design the unit so that a broken antenna can be replaced by the user, but the use of a standard antenna jack or electrical connector is prohibited.</p> <p>15.247(b) (4) requirement: The conducted output power limit specified in paragraph (b) of this section is based on the use of antennas with directional gains that do not exceed 6 dBi. Except as shown in paragraph (c) of this section, if transmitting antennas of directional gain greater than 6 dBi are used, the conducted output power from the intentional radiator shall be reduced below the stated values in paragraphs (b)(1), (b)(2), and (b)(3) of this section, as appropriate, by the amount in dB that the directional gain of the antenna exceeds 6 dBi</p> |
| <p>EUT Antenna: The non-detachable antenna inside the device cannot be replaced by the user at will. The gain of the antenna is 1.42dBi.</p> |

Any report having not been signed by authorized approver, or having been altered without authorization, or having not been stamped by the "Dedicated Testing/Inspection Stamp" is deemed to be invalid. Copying or excerpting portion of, or altering the content of the report is not permitted without the written authorization of AGC. The test results presented in the report apply only to the tested sample. Any objections to report issued by AGC should be submitted to AGC within 15days after the issuance of the test report. Further enquiry of validity or verification of the test report should be addressed to AGC by agc01@agccert.com.

2.9 Description of Test Software

For IEEE 802.11 mode:

The test utility software used during testing was “SecureCRT”.

Software Setting Diagram

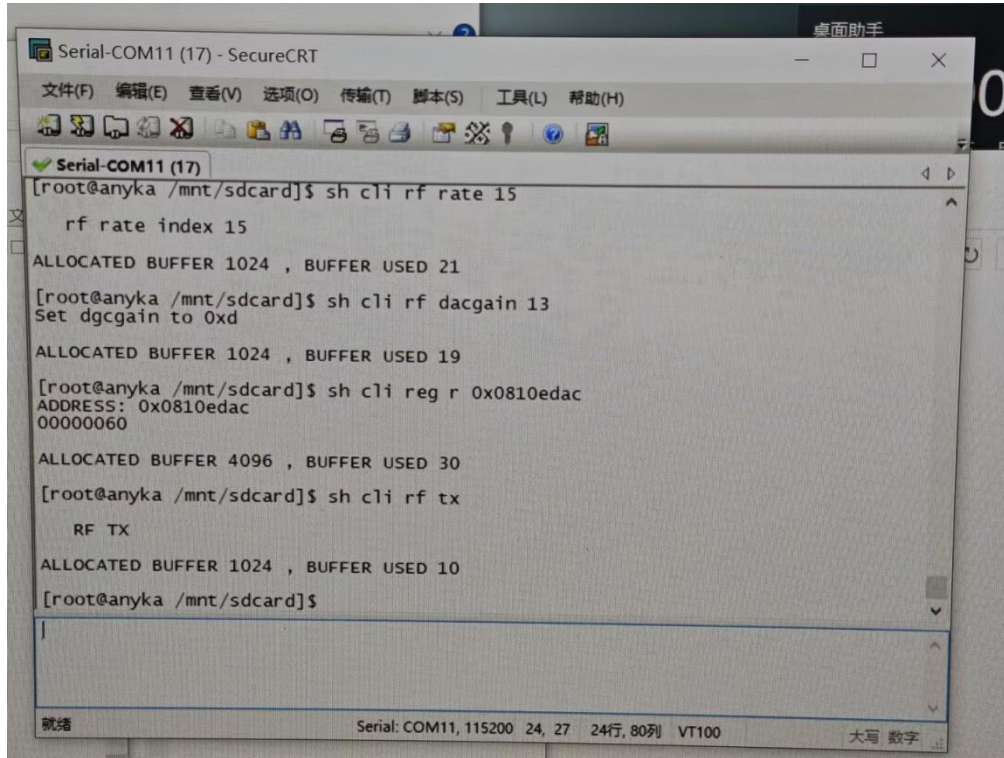

```

Serial-COM11 (17) - SecureCRT
文件(F) 编辑(E) 查看(V) 选项(O) 传输(T) 脚本(S) 工具(L) 帮助(H)
Serial-COM11 (17)
[root@anyka /mnt/sdcard]$ sh cli rf rate 15
rf rate index 15
ALLOCATED BUFFER 1024 , BUFFER USED 21
[root@anyka /mnt/sdcard]$ sh cli rf dacgain 13
Set dgcgain to 0xd
ALLOCATED BUFFER 1024 , BUFFER USED 19
[root@anyka /mnt/sdcard]$ sh cli reg r 0x0810edac
ADDRESS: 0x0810edac
00000060
ALLOCATED BUFFER 4096 , BUFFER USED 30
[root@anyka /mnt/sdcard]$ sh cli rf tx
RF TX
ALLOCATED BUFFER 1024 , BUFFER USED 10
[root@anyka /mnt/sdcard]$
就绪 Serial: COM11, 115200 24, 27 24行, 80列 VT100 大写 数字
  
```

| Test Mode | Channel | Power Index |
|--------------|---------|-------------|
| 802.11b | L/M/H | 74 |
| 802.11g | L/M/H | 74 |
| 802.11n-HT20 | L/M/H | 74 |

Any report having not been signed by authorized approver, or having been altered without authorization, or having not been stamped by the “Dedicated Testing/Inspection Stamp” is deemed to be invalid. Copying or excerpting portion of, or altering the content of the report is not permitted without the written authorization of AGC. The test results presented in the report apply only to the tested sample. Any objections to report issued by AGC should be submitted to AGC within 15days after the issuance of the test report. Further enquiry of validity or verification of the test report should be addressed to AGC by agc01@agccert.com.

3. Test Environment

3.1 Address of The Test Laboratory

Laboratory: Attestation of Global Compliance (Shenzhen) Co., Ltd.

Address: 1-2/F, Building 19, Junfeng Industrial Park, Chongqing Road, Heping Community, Fuhai Street, Bao'an District, Shenzhen, Guangdong, China

3.2 Test Facility

The test facility is recognized, certified, or accredited by the following organizations:

CNAS-Lab Code: L5488

Attestation of Global Compliance (Shenzhen) Co., Ltd. has been assessed and proved to follow CNAS-CL01 Accreditation Criteria for Testing and Calibration Laboratories (identical to ISO/IEC17025: 2017 General Requirements for the Competence of Testing and Calibration Laboratories).

A2LA-Lab Cert. No.: 5054.02

Attestation of Global Compliance (Shenzhen) Co., Ltd. EMC Laboratory has been accredited by A2LA for technical competence in the field of electrical testing, and proved to follow ISO/IEC 17025: 2017 General Requirements for the Competence of Testing and Calibration Laboratories and any additional program requirements in the identified field of testing.

FCC-Registration No.: 975832

Attestation of Global Compliance (Shenzhen) Co., Ltd. EMC Laboratory has been registered and fully described in a report filed with the FCC (Federal Communications Commission). The acceptance letter from the FCC is maintained in our files with Registration 975832.

IC-Registration No.: 24842 (CAB identifier: CN0063)

Attestation of Global Compliance (Shenzhen) Co., Ltd. EMC Laboratory has been registered and fully described in a report filed with the Certification and Engineering Bureau of Industry Canada. The acceptance letter from the IC is maintained in our files with Registration 24842.

Any report having not been signed by authorized approver, or having been altered without authorization, or having not been stamped by the "Dedicated Testing/Inspection Stamp" is deemed to be invalid. Copying or excerpting portion of, or altering the content of the report is not permitted without the written authorization of AGC. The test results presented in the report apply only to the tested sample. Any objections to report issued by AGC should be submitted to AGC within 15days after the issuance of the test report. Further enquiry of validity or verification of the test report should be addressed to AGC by agc01@agccert.com.

3.3 Environmental Conditions

| | Normal Conditions |
|-------------------------|-------------------|
| Temperature range (°C) | 15 - 35 |
| Relative humidity range | 20 % - 75 % |
| Pressure range (kPa) | 86 - 106 |

3.4 Measurement Uncertainty

The reported uncertainty of measurement $y \pm U$, where expanded uncertainty U is based on a standard uncertainty multiplied by a coverage factor of $k=2$, providing a level of confidence of approximately 95%.

| Item | Measurement Uncertainty |
|---|-------------------------|
| Uncertainty of Conducted Emission for AC Port | $U_c = \pm 2.9$ dB |
| Uncertainty of Radiated Emission below 1GHz | $U_c = \pm 3.9$ dB |
| Uncertainty of Radiated Emission above 1GHz | $U_c = \pm 4.9$ dB |
| Uncertainty of total RF power, conducted | $U_c = \pm 0.8$ dB |
| Uncertainty of RF power density, conducted | $U_c = \pm 2.6$ dB |
| Uncertainty of spurious emissions, conducted | $U_c = \pm 2$ % |
| Uncertainty of Occupied Channel Bandwidth | $U_c = \pm 2$ % |

Any report having not been signed by authorized approver, or having been altered without authorization, or having not been stamped by the "Dedicated Testing/Inspection Stamp" is deemed to be invalid. Copying or excerpting portion of, or altering the content of the report is not permitted without the written authorization of AGC. The test results presented in the report apply only to the tested sample. Any objections to report issued by AGC should be submitted to AGC within 15days after the issuance of the test report. Further enquiry of validity or verification of the test report should be addressed to AGC by agc01@agccert.com.

3.5 List of Equipment Used

| ● RF Conducted Test System | | | | | | | |
|-------------------------------------|---------------|---------------------|--------------|------------|------------|---------------------------|---------------------------|
| Used | Equipment No. | Test Equipment | Manufacturer | Model No. | Serial No. | Last Cal. Date (YY-MM-DD) | Next Cal. Date (YY-MM-DD) |
| <input checked="" type="checkbox"/> | AGC-ER-E036 | Spectrum Analyzer | Agilent | N9020A | MY49100060 | 2024-05-23 | 2025-05-22 |
| <input checked="" type="checkbox"/> | AGC-ER-E062 | Power Sensor | Agilent | U2021XA | MY54110007 | 2024-02-01 | 2025-01-31 |
| <input checked="" type="checkbox"/> | AGC-ER-E063 | Power Sensor | Agilent | U2021XA | MY54110009 | 2024-02-01 | 2025-01-31 |
| <input checked="" type="checkbox"/> | AGC-EM-A152 | 6dB Attenuator | Eeatsheep | LM-XX-6-5W | N/A | 2023-06-09 | 2024-06-08 |
| <input checked="" type="checkbox"/> | AGC-ER-E083 | Signal Generator | Agilent | E4421B | US39340815 | 2024-02-01 | 2025-01-31 |
| <input checked="" type="checkbox"/> | N/A | RF Connection Cable | N/A | 1# | N/A | Each time | N/A |
| <input checked="" type="checkbox"/> | N/A | RF Connection Cable | N/A | 2# | N/A | Each time | N/A |

| ● Radiated Spurious Emission | | | | | | | |
|-------------------------------------|---------------|-------------------------------|--------------|------------|------------|---------------------------|---------------------------|
| Used | Equipment No. | Test Equipment | Manufacturer | Model No. | Serial No. | Last Cal. Date (YY-MM-DD) | Next Cal. Date (YY-MM-DD) |
| <input type="checkbox"/> | AGC-EM-E046 | EMI Test Receiver | R&S | ESCI | 10096 | 2024-02-01 | 2025-01-31 |
| <input checked="" type="checkbox"/> | AGC-EM-E116 | EMI Test Receiver | R&S | ESCI | 100034 | 2024-05-24 | 2025-05-23 |
| <input checked="" type="checkbox"/> | AGC-EM-E061 | Spectrum Analyzer | Agilent | N9010A | MY53470504 | 2024-05-28 | 2025-05-27 |
| <input checked="" type="checkbox"/> | AGC-EM-E086 | Loop Antenna | ZHINAN | ZN30900C | 18051 | 2024-03-05 | 2026-03-04 |
| <input checked="" type="checkbox"/> | AGC-EM-E001 | Wideband Antenna | SCHWARZBECK | VULB9168 | D69250 | 2023-05-11 | 2025-05-10 |
| <input checked="" type="checkbox"/> | AGC-EM-E029 | Broadband Ridged Horn Antenna | ETS | 3117 | 00034609 | 2024-03-31 | 2025-03-30 |
| <input checked="" type="checkbox"/> | AGC-EM-E082 | Horn Antenna | SCHWARZBECK | BBHA 9170 | #768 | 2023-09-24 | 2025-09-23 |
| <input checked="" type="checkbox"/> | AGC-EM-E146 | Pre-amplifier | ETS | 3117-PA | 00246148 | 2022-08-04 | 2024-08-03 |
| <input checked="" type="checkbox"/> | AGC-EM-A119 | 2.4G Filter | SongYi | N/A | N/A | 2024-05-23 | 2025-05-22 |
| <input checked="" type="checkbox"/> | AGC-EM-A138 | 6dB Attenuator | Eeatsheep | LM-XX-6-5W | N/A | 2023-06-09 | 2024-06-08 |
| <input type="checkbox"/> | AGC-EM-A139 | 6dB Attenuator | Eeatsheep | LM-XX-6-5W | N/A | 2023-06-09 | 2024-06-08 |

| ● AC Power Line Conducted Emission | | | | | | | |
|-------------------------------------|---------------|-------------------|--------------|------------|------------|---------------------------|---------------------------|
| Used | Equipment No. | Test Equipment | Manufacturer | Model No. | Serial No. | Last Cal. Date (YY-MM-DD) | Next Cal. Date (YY-MM-DD) |
| <input checked="" type="checkbox"/> | AGC-EM-E045 | EMI Test Receiver | R&S | ESPI | 101206 | 2024-05-28 | 2025-05-27 |
| <input checked="" type="checkbox"/> | AGC-EM-A130 | 6dB Attenuator | Eeatsheep | LM-XX-6-5W | DC-6GZ | 2023-06-09 | 2024-06-08 |
| <input checked="" type="checkbox"/> | AGC-EM-E023 | AMN | R&S | 100086 | ESH2-Z5 | 2024-05-28 | 2025-05-27 |

Any report having not been signed by authorized approver, or having been altered without authorization, or having not been stamped by the "Dedicated Testing/Inspection Stamp" is deemed to be invalid. Copying or excerpting portion of, or altering the content of the report is not permitted without the written authorization of AGC. The test results presented in the report apply only to the tested sample. Any objections to report issued by AGC should be submitted to AGC within 15days after the issuance of the test report. Further enquiry of validity or verification of the test report should be addressed to AGC by agc01@agccert.com.

| ● Test Software | | | | | |
|-------------------------------------|---------------|---------------------|--------------|----------------------|---------------------|
| Used | Equipment No. | Test Equipment | Manufacturer | Model No. | Version Information |
| <input checked="" type="checkbox"/> | AGC-EM-S001 | CE Test System | R&S | ES-K1 | V1.71 |
| <input checked="" type="checkbox"/> | AGC-EM-S003 | RE Test System | FARA | EZ-EMC | VRA-03A |
| <input checked="" type="checkbox"/> | AGC-ER-S012 | BT/WIFI Test System | Tonscend | JS1120-2 | 2.6 |
| <input checked="" type="checkbox"/> | AGC-EM-S011 | RSE Test System | Tonscend | TS+-Ver2.1(JS36-RSE) | 4.0.0.0 |

Any report having not been signed by authorized approver, or having been altered without authorization, or having not been stamped by the "Dedicated Testing/Inspection Stamp" is deemed to be invalid. Copying or excerpting portion of, or altering the content of the report is not permitted without the written authorization of AGC. The test results presented in the report apply only to the tested sample. Any objections to report issued by AGC should be submitted to AGC within 15days after the issuance of the test report. Further enquiry of validity or verification of the test report should be addressed to AGC by agc01@agccert.com.

4. System Test Configuration

4.1 EUT Configuration

The EUT configuration for testing is installed on RF field strength measurement to meet the Commission's requirement and operating in a manner which intends to maximize its emission characteristics in a continuous normal application.

4.2 EUT Exercise

The Transmitter was operated in the normal operating mode. The TX frequency was fixed which was for the purpose of the measurements.

4.3 Configuration of Tested System

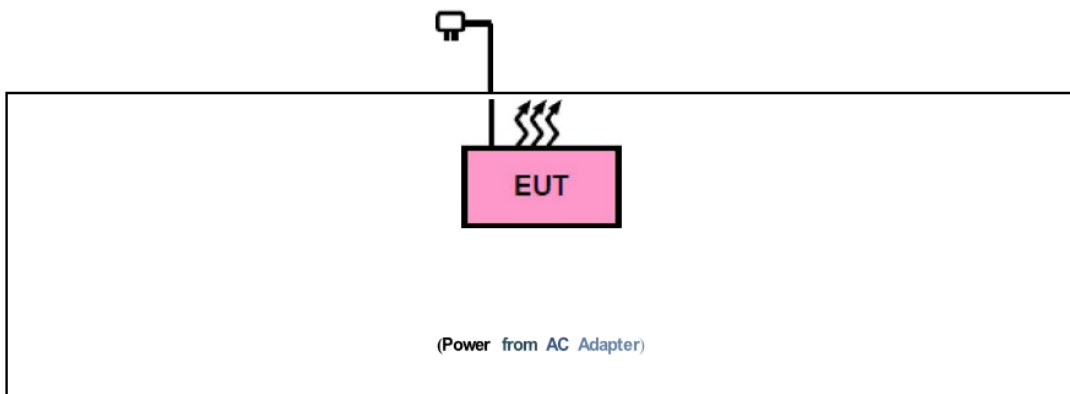

4.4 Equipment Used in Tested System

The following peripheral devices and interface cables were connected during the measurement:

Test Accessories Come From The Laboratory

| No. | Equipment | Model No. | Manufacturer | Specification Information | Cable |
|-----|---------------|-----------|--------------|---------------------------|-------|
| 1 | Control Box | -- | USB-TTL | -- | -- |
| 2 | Iphone8 Phone | Apple | MQ6K2CH/A | -- | -- |

Test Accessories Come From The Manufacturer

| No. | Equipment | Model No. | Manufacturer | Specification Information | Cable |
|-----|-----------|-----------|-------------------|---|-------|
| 1 | Adapter | -- | DCT06W050100US-C0 | Input: 100-240V~50/60Hz 200mA Output: 5.0V, 1.0A | -- |

Any report having not been signed by authorized approver, or having been altered without authorization, or having not been stamped by the "Dedicated Testing/Inspection Stamp" is deemed to be invalid. Copying or excerpting portion of, or altering the content of the report is not permitted without the written authorization of AGC. The test results presented in the report apply only to the tested sample. Any objections to report issued by AGC should be submitted to AGC within 15days after the issuance of the test report. Further enquiry of validity or verification of the test report should be addressed to AGC by agc01@agccert.com.

4.5 Summary of Test Results

| Item | FCC Rules | Description of Test | Result |
|------|----------------------|---|--------|
| 1 | §15.203&15.247(b)(4) | Antenna Equipment | Pass |
| 2 | §15.247 (b)(1) | RF Output Power | Pass |
| 3 | §15.247 (a)(1) | 6 dB Bandwidth | Pass |
| 4 | §15.247 (e) | Power Spectral Density | Pass |
| 5 | §15.247 (d) | Conducted Band Edge and Out-of-Band Emissions | Pass |
| 6 | §15.247 (d)&15.209 | Radiated Spurious Emission | Pass |
| 7 | §15.207 | AC Power Line Conducted Emission | Pass |

Any report having not been signed by authorized approver, or having been altered without authorization, or having not been stamped by the "Dedicated Testing/Inspection Stamp" is deemed to be invalid. Copying or excerpting portion of, or altering the content of the report is not permitted without the written authorization of AGC. The test results presented in the report apply only to the tested sample. Any objections to report issued by AGC should be submitted to AGC within 15days after the issuance of the test report. Further enquiry of validity or verification of the test report should be addressed to AGC by agc01@agccert.com.

5. Description of Test Modes

| Summary table of Test Cases | |
|---------------------------------|---|
| Test Item | Data Rate / Modulation |
| | 2.4G WLAN – 802.11b/g/n (DSSS/OFDM) |
| Radiated & Conducted Test Cases | Mode 1: 802.11b_TX CH01_2412 MHz_1 Mbps(AC/DC adapter) Mode 2: 802.11b_TX CH06_2437 MHz_1 Mbps(AC/DC adapter) Mode 3: 802.11b_TX CH11_2462 MHz_1 Mbps(AC/DC adapter) Mode 4: 802.11g_TX CH01_2412 MHz_6 Mbps(AC/DC adapter) Mode 5: 802.11g_TX CH06_2437 MHz_6 Mbps(AC/DC adapter) Mode 6: 802.11g_TX CH11_2462 MHz_6 Mbps (AC/DC adapter) Mode 7: 802.11n-HT20_TX CH01_2412 MHz_MCS0 Mbps(AC/DC adapter) Mode 8: 802.11n-HT20_TX CH06_2437 MHz_MCS0 Mbps(AC/DC adapter) Mode 9: 802.11n-HT20_TX CH11_2462 MHz_MCS0 Mbps(AC/DC adapter) |
| AC Conducted Emission | Mode 1: 2.4G WLAN Link +USB Cable (AC/DC adapter) |

Note:

1. Only the result of the worst case was recorded in the report, if no other cases.
2. For Radiated Emission, 3axis were chosen for testing for each applicable mode.
3. For Conducted Test method, a temporary antenna connector is provided by the manufacture.

Any report having not been signed by authorized approver, or having been altered without authorization, or having not been stamped by the “Dedicated Testing/Inspection Stamp” is deemed to be invalid. Copying or excerpting portion of, or altering the content of the report is not permitted without the written authorization of AGC. The test results presented in the report apply only to the tested sample. Any objections to report issued by AGC should be submitted to AGC within 15days after the issuance of the test report. Further enquiry of validity or verification of the test report should be addressed to AGC by agc01@agccert.com.

6. Duty Cycle Measurement

2.4GHz WLAN (DTS) operation is possible in 20MHz channel bandwidths. The maximum achievable duty cycles for all modes were determined based on measurements performed on a spectrum analyzer in zero-span mode with RBW = 8MHz, VBW = 50MHz, and detector = Peak. The RBW and VBW were both greater than 50/T, where T is the minimum transmission duration, and the number of sweep points across T was greater than 100. The duty cycles are as follows:

| Operating mode | Data rates (Mbps) | Duty Cycle (%) | Duty Cycle Factor (dB) | 1/ T Minimum VBW (kHz) | Average Factor (dB) |
|-------------------|-------------------|----------------|------------------------|------------------------|---------------------|
| IEEE 802.11b | 1 | 97.98 | 0.09 | 0.12 | -0.18 |
| IEEE 802.11g | 6 | 88.83 | 0.51 | 0.74 | -1.03 |
| IEEE 802.11n-HT20 | MCS0 | 96.80 | 0.14 | 0.20 | -0.28 |

Remark:

1. Duty Cycle factor = $10 * \log (1/ \text{Duty cycle})$
2. Average factor = $20 \log_{10} \text{Duty Cycle}$
3. The duty cycle of each frequency band mode reflects the determination requirements of the low channel measurement value.

Any report having not been signed by authorized approver, or having been altered without authorization, or having not been stamped by the "Dedicated Testing/Inspection Stamp" is deemed to be invalid. Copying or excerpting portion of, or altering the content of the report is not permitted without the written authorization of AGC. The test results presented in the report apply only to the tested sample. Any objections to report issued by AGC should be submitted to AGC within 15days after the issuance of the test report. Further enquiry of validity or verification of the test report should be addressed to AGC by agc01@agccert.com.

The test plots as follows:

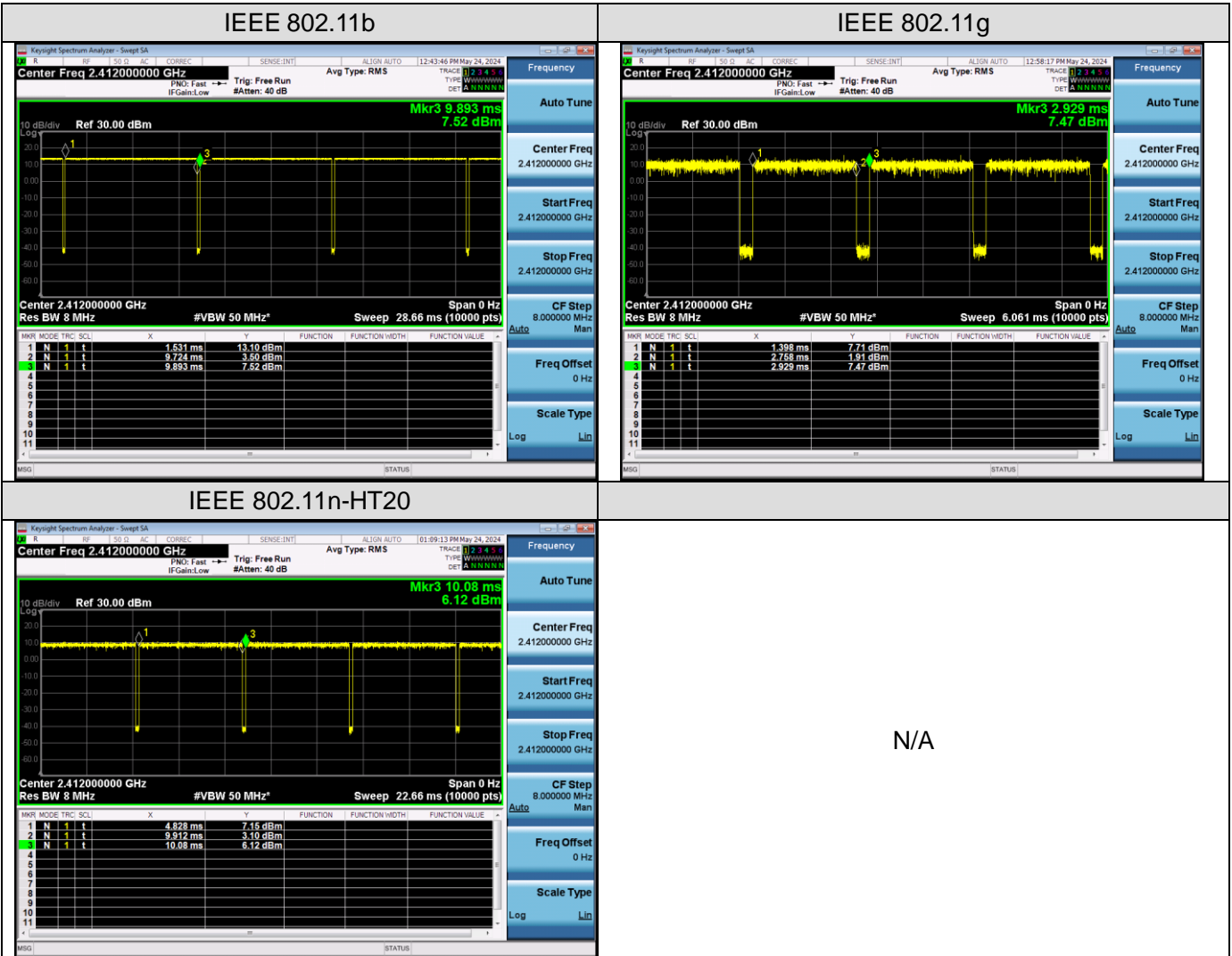

Any report having not been signed by authorized approver, or having been altered without authorization, or having not been stamped by the "Dedicated Testing/Inspection Stamp" is deemed to be invalid. Copying or excerpting portion of, or altering the content of the report is not permitted without the written authorization of AGC. The test results presented in the report apply only to the tested sample. Any objections to report issued by AGC should be submitted to AGC within 15days after the issuance of the test report. Further enquiry of validity or verification of the test report should be addressed to AGC by agc01@agccert.com.

7. RF Output Power Measurement

7.1 Provisions Applicable

For DTSs employing digital modulation techniques operating in the bands 2400-2483.5 MHz, the maximum peak conducted output power shall not exceed 1 W.

7.2 Measurement Procedure

Method PM is Measurement using an RF Peak power meter. The procedure for this method is as follows:

1. The testing follows the ANSI C63.10 Section 11.9.1.3
2. The maximum peak conducted output power may be measured using a broadband peak RF power meter. The power meter shall have a video bandwidth that is greater than or equal to the DTS bandwidth and shall use a fast-responding diode detector.

Method PM is Measurement using an RF average power meter. The procedure for this method is as follows:

1. The testing follows the ANSI C63.10 Section 11.9.2.3
2. Measurements may be performed using a wideband RF power meter with a thermocouple detector or equivalent if all of the following conditions are satisfied:
3. The EUT is configured to transmit continuously, or to transmit with a constant duty cycle.
4. At all times when the EUT is transmitting, it shall be transmitting at its maximum power control level.
5. The integration period of the power meter exceeds the repetition period of the transmitted signal by at least a factor of five.
6. Determine according to the duty cycle of the equipment: when it is less than 98%, follow the steps below.
7. Measure the average power of the transmitter. This measurement is an average over both the ON and OFF periods of the transmitter.
8. Adjust the measurement in dBm by adding $[10 \log (1 / D)]$, where D is the duty cycle {e.g., $[10 \log (1 / 0.25)]$, if the duty cycle is 25%}.
9. Record the test results in the report.

7.3 Measurement Setup (Block Diagram of Configuration)

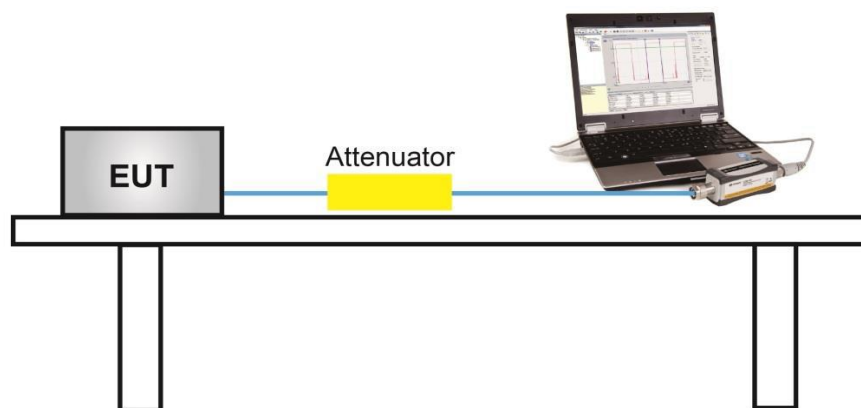

Any report having not been signed by authorized approver, or having been altered without authorization, or having not been stamped by the “Dedicated Testing/Inspection Stamp” is deemed to be invalid. Copying or excerpting portion of, or altering the content of the report is not permitted without the written authorization of AGC. The test results presented in the report apply only to the tested sample. Any objections to report issued by AGC should be submitted to AGC within 15days after the issuance of the test report. Further enquiry of validity or verification of the test report should be addressed to AGC by agc01@agccert.com.

7.4 Measurement Result

| Test Data of Conducted Output Power | | | | | |
|-------------------------------------|----------------------|---------------------|------------------|--------------|--------------|
| Test Mode | Test Frequency (MHz) | Average Power (dBm) | Peak Power (dBm) | Limits (dBm) | Pass or Fail |
| 802.11b | 2412 | 14.48 | 17.62 | ≤30 | Pass |
| | 2437 | 13.89 | 16.64 | ≤30 | Pass |
| | 2462 | 13.63 | 16.58 | ≤30 | Pass |
| 802.11g | 2412 | 13.35 | 21.07 | ≤30 | Pass |
| | 2437 | 12.91 | 20.58 | ≤30 | Pass |
| | 2462 | 12.80 | 20.53 | ≤30 | Pass |
| 802.11n20 | 2412 | 12.49 | 20.21 | ≤30 | Pass |
| | 2437 | 12.10 | 20.04 | ≤30 | Pass |
| | 2462 | 10.75 | 18.42 | ≤30 | Pass |

Any report having not been signed by authorized approver, or having been altered without authorization, or having not been stamped by the “Dedicated Testing/Inspection Stamp” is deemed to be invalid. Copying or excerpting portion of, or altering the content of the report is not permitted without the written authorization of AGC. The test results presented in the report apply only to the tested sample. Any objections to report issued by AGC should be submitted to AGC within 15days after the issuance of the test report. Further enquiry of validity or verification of the test report should be addressed to AGC by agc01@agccert.com.

8. 6dB Bandwidth Measurement

8.1 Provisions Applicable

The minimum 6dB bandwidth shall be 500 kHz.

8.2 Measurement Procedure

The testing follows the ANSI C63.10 Section 6.9.3 (OBW) and 11.8.1 (6dB BW).

1. The RF output of EUT was connected to the spectrum analyzer by RF cable and attenuator. The path loss was compensated to the results for each measurement.
2. Set to the maximum power setting and enable the EUT transmit continuously.
3. For 6dB Bandwidth Measurement, the spectrum analyzer's resolution bandwidth (RBW) = 100 kHz. Set the Video bandwidth (VBW) = 300 kHz. In order to make an accurate measurement.
4. For 99% Bandwidth Measurement, the spectrum analyzer's resolution bandwidth (RBW) is set 1-5% of the OBW and set the Video bandwidth (VBW) $\geq 3 * RBW$.
5. Detector = peak
6. Trace mode = max hold.
7. Sweep = auto couple.
8. Allow the trace to stabilize.
9. Measure and record the results in the test report.

8.3 Measurement Setup (Block Diagram of Configuration)

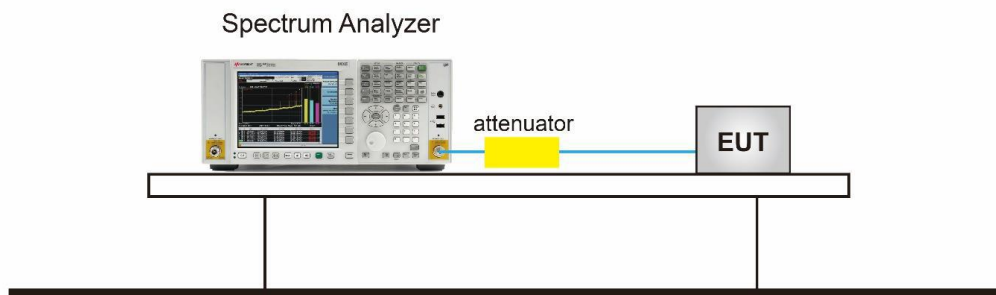

Any report having not been signed by authorized approver, or having been altered without authorization, or having not been stamped by the "Dedicated Testing/Inspection Stamp" is deemed to be invalid. Copying or excerpting portion of, or altering the content of the report is not permitted without the written authorization of AGC. The test results presented in the report apply only to the tested sample. Any objections to report issued by AGC should be submitted to AGC within 15days after the issuance of the test report. Further enquiry of validity or verification of the test report should be addressed to AGC by agc01@agccert.com.

8.4 Measurement Result

| Test Data of Occupied Bandwidth and DTS Bandwidth | | | | | |
|---|----------------------|------------------------------|---------------------|----------------------------|--------------|
| Test Mode | Test Frequency (MHz) | 99% Occupied Bandwidth (MHz) | DTS Bandwidth (MHz) | DTS Bandwidth Limits (MHz) | Pass or Fail |
| 802.11b | 2412 | 15.024 | 10.057 | ≥ 0.5 | Pass |
| | 2437 | 15.031 | 10.065 | ≥ 0.5 | Pass |
| | 2462 | 15.031 | 10.061 | ≥ 0.5 | Pass |
| 802.11g | 2412 | 16.902 | 16.409 | ≥ 0.5 | Pass |
| | 2437 | 16.743 | 16.406 | ≥ 0.5 | Pass |
| | 2462 | 16.781 | 16.393 | ≥ 0.5 | Pass |
| 802.11n20 | 2412 | 17.895 | 17.609 | ≥ 0.5 | Pass |
| | 2437 | 17.973 | 17.621 | ≥ 0.5 | Pass |
| | 2462 | 17.919 | 17.639 | ≥ 0.5 | Pass |

Any report having not been signed by authorized approver, or having been altered without authorization, or having not been stamped by the "Dedicated Testing/Inspection Stamp" is deemed to be invalid. Copying or excerpting portion of, or altering the content of the report is not permitted without the written authorization of AGC. The test results presented in the report apply only to the tested sample. Any objections to report issued by AGC should be submitted to AGC within 15days after the issuance of the test report. Further enquiry of validity or verification of the test report should be addressed to AGC by agc01@agccert.com.

Test Graphs of Occupied Bandwidth

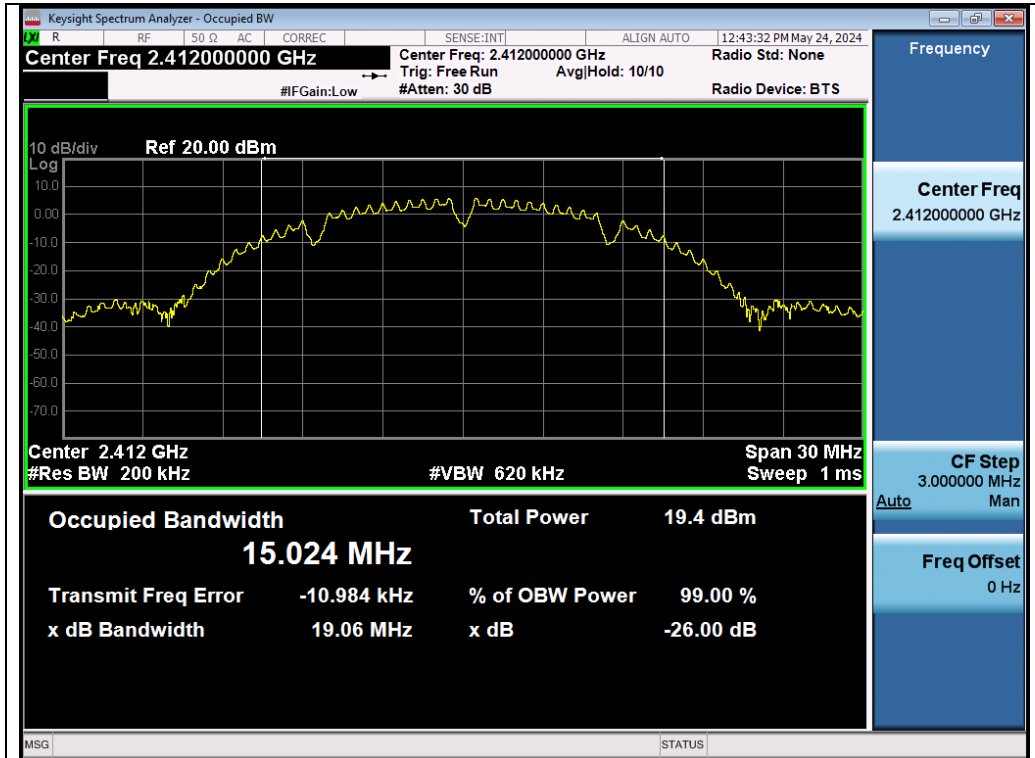

Test_Graph_802.11b_ANT1_2412_1Mbps_OBW

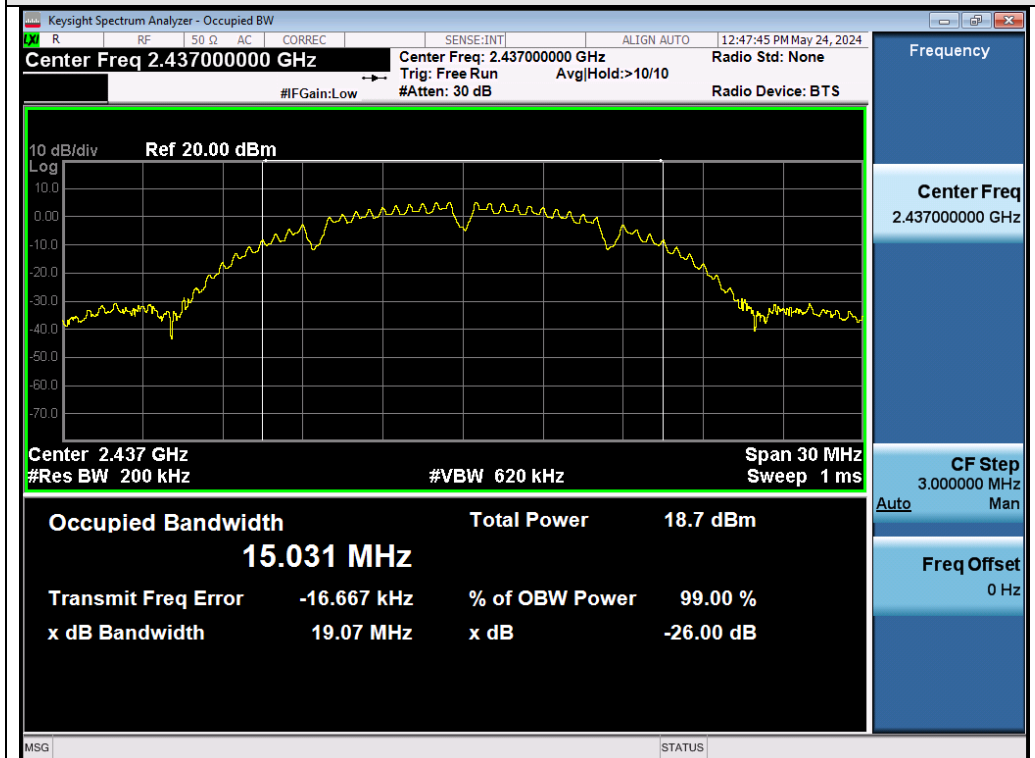

Test_Graph_802.11b_ANT1_2437_1Mbps_OBW

Any report having not been signed by authorized approver, or having been altered without authorization, or having not been stamped by the "Dedicated Testing/Inspection Stamp" is deemed to be invalid. Copying or excerpting portion of, or altering the content of the report is not permitted without the written authorization of AGC. The test results presented in the report apply only to the tested sample. Any objections to report issued by AGC should be submitted to AGC within 15days after the issuance of the test report. Further enquiry of validity or verification of the test report should be addressed to AGC by agc01@agccert.com.

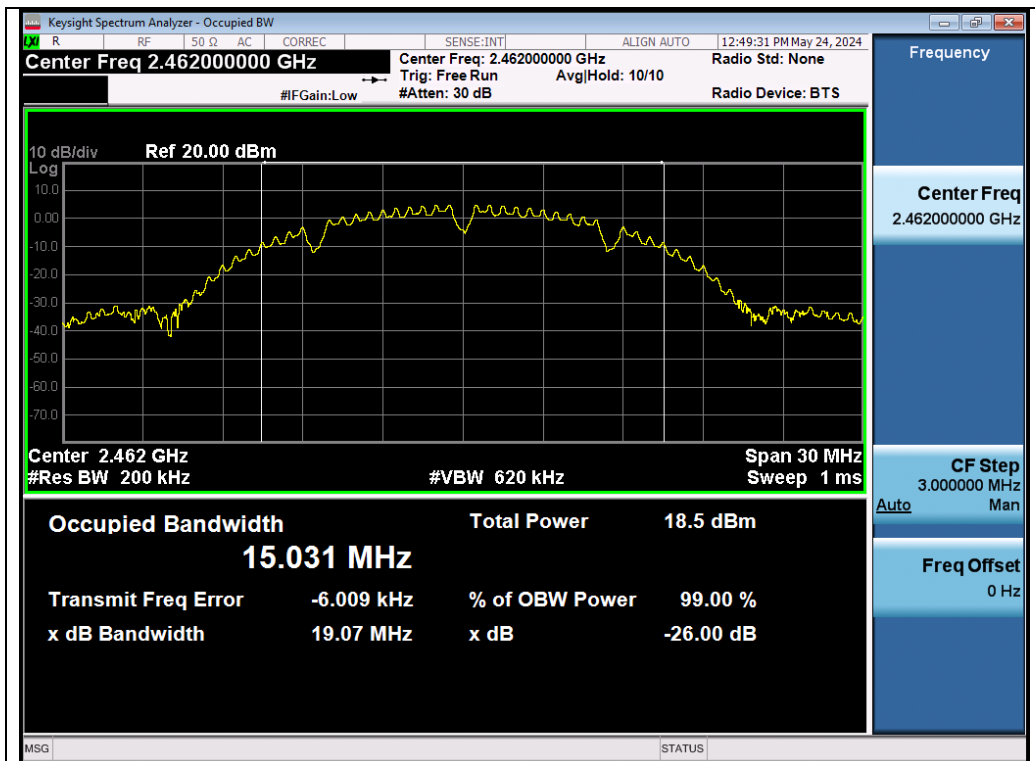

Test_Graph_802.11b_ANT1_2462_1Mbps_OBW

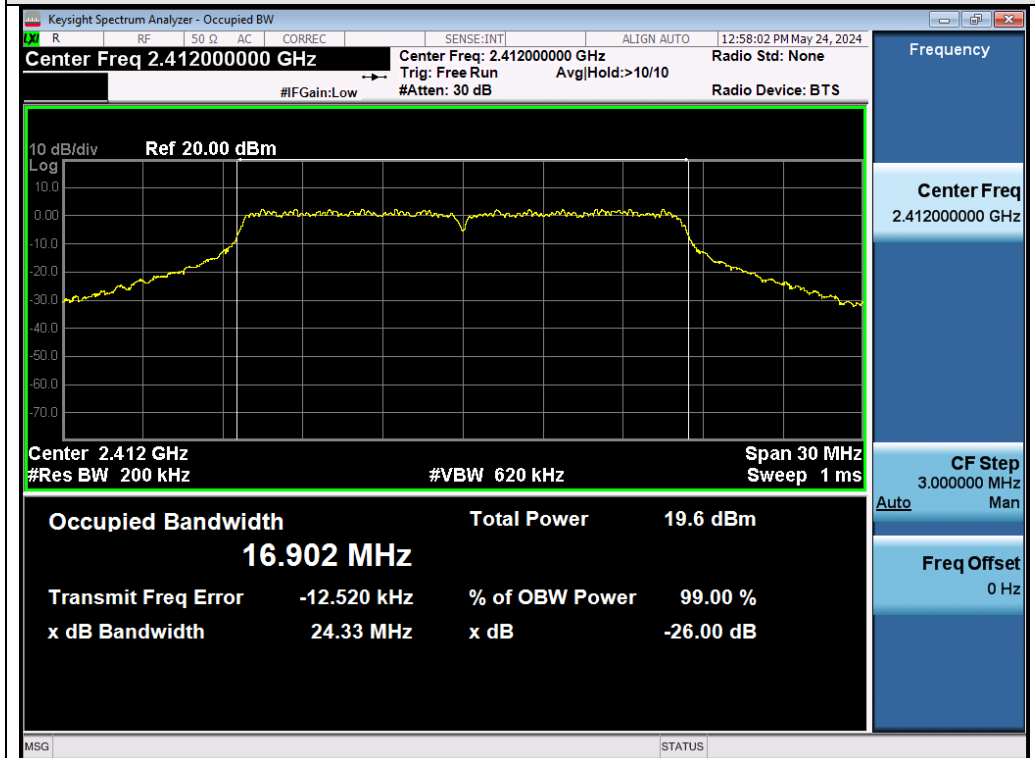

Test_Graph_802.11g_ANT1_2412_6Mbps_OBW

Any report having not been signed by authorized approver, or having been altered without authorization, or having not been stamped by the "Dedicated Testing/Inspection Stamp" is deemed to be invalid. Copying or excerpting portion of, or altering the content of the report is not permitted without the written authorization of AGC. The test results presented in the report apply only to the tested sample. Any objections to report issued by AGC should be submitted to AGC within 15 days after the issuance of the test report. Further enquiry of validity or verification of the test report should be addressed to AGC by agc01@agccert.com.

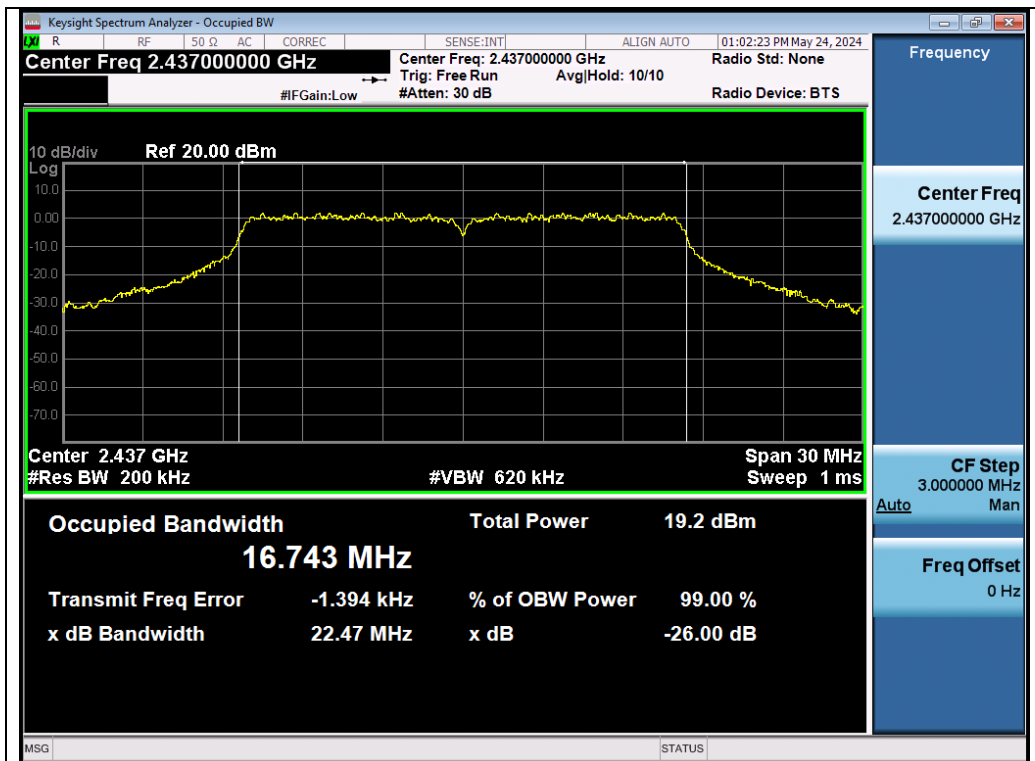

Test_Graph_802.11g_ANT1_2437_6Mbps_OBW

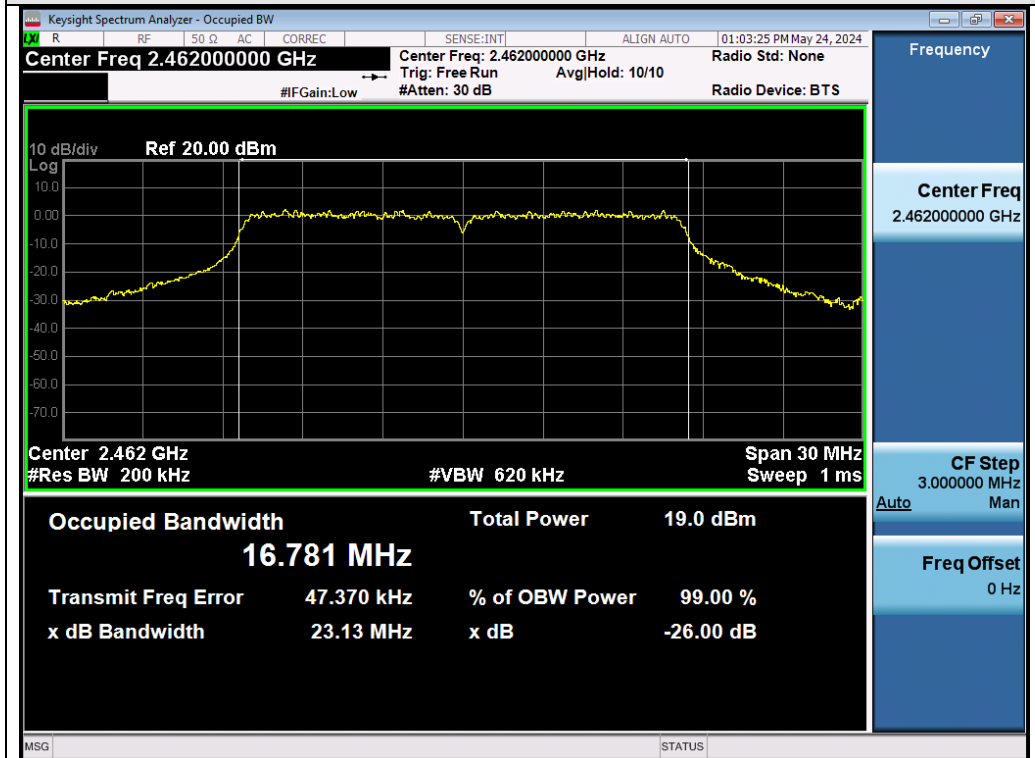

Test_Graph_802.11g_ANT1_2462_6Mbps_OBW

Any report having not been signed by authorized approver, or having been altered without authorization, or having not been stamped by the "Dedicated Testing/Inspection Stamp" is deemed to be invalid. Copying or excerpting portion of, or altering the content of the report is not permitted without the written authorization of AGC. The test results presented in the report apply only to the tested sample. Any objections to report issued by AGC should be submitted to AGC within 15days after the issuance of the test report. Further enquiry of validity or verification of the test report should be addressed to AGC by agc01@agccert.com.

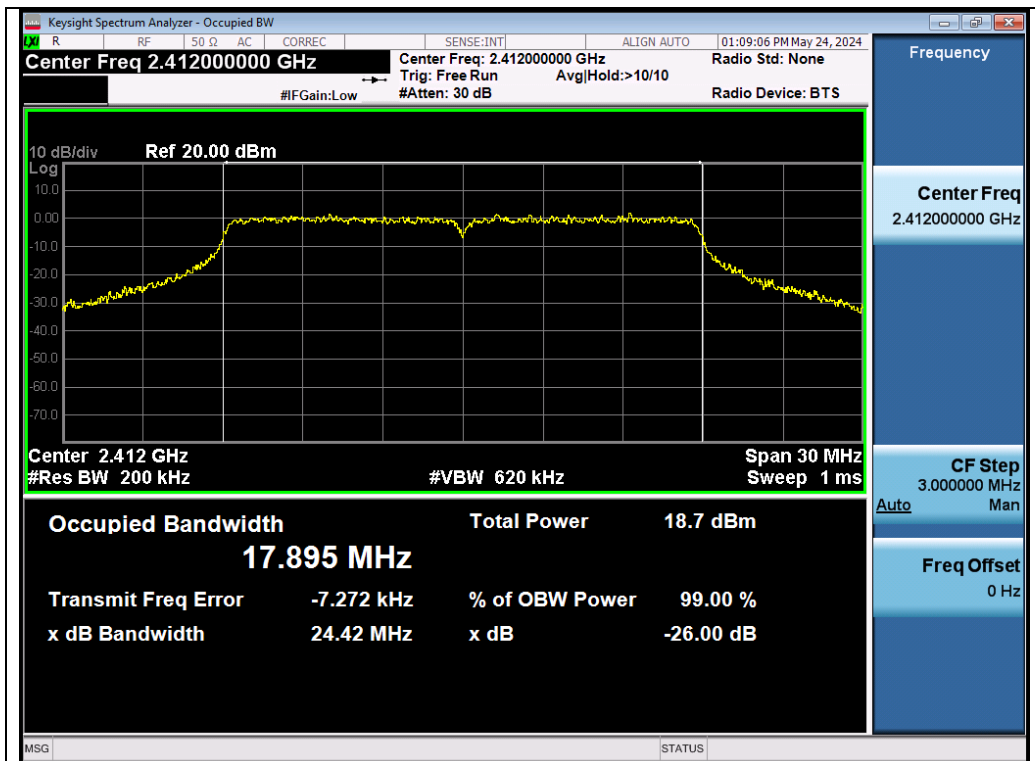

Test_Graph_802.11n20_ANT1_2412_MCS0_OBW

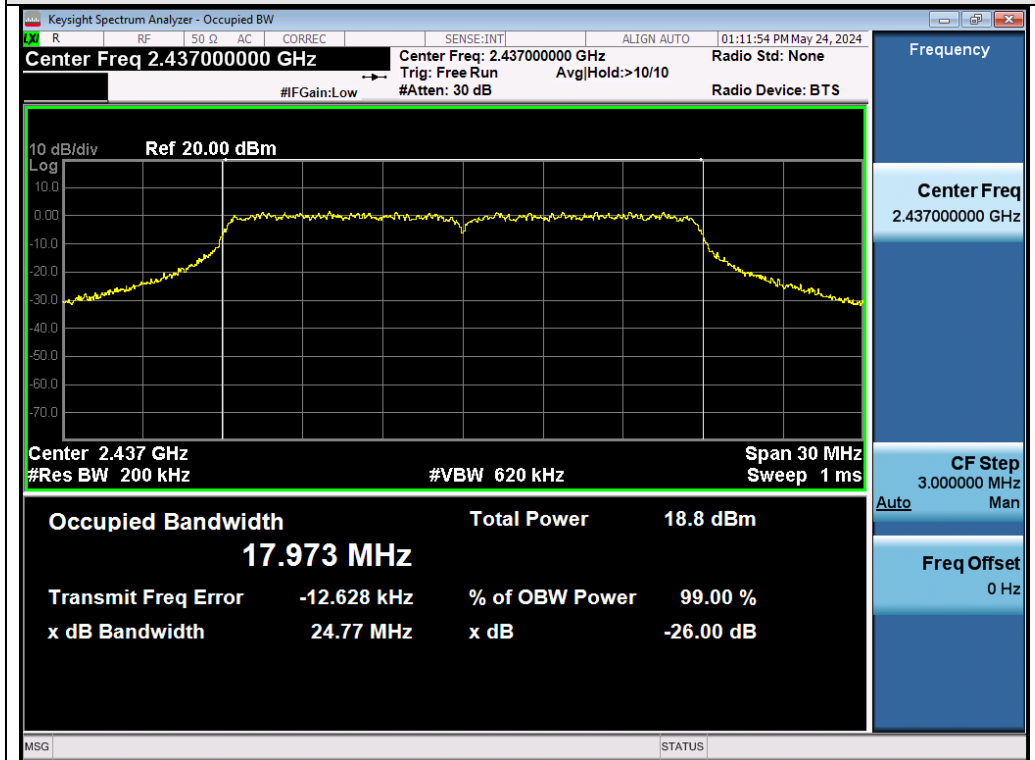

Test_Graph_802.11n20_ANT1_2437_MCS0_OBW

Any report having not been signed by authorized approver, or having been altered without authorization, or having not been stamped by the "Dedicated Testing/Inspection Stamp" is deemed to be invalid. Copying or excerpting portion of, or altering the content of the report is not permitted without the written authorization of AGC. The test results presented in the report apply only to the tested sample. Any objections to report issued by AGC should be submitted to AGC within 15days after the issuance of the test report. Further enquiry of validity or verification of the test report should be addressed to AGC by agc01@agccert.com.

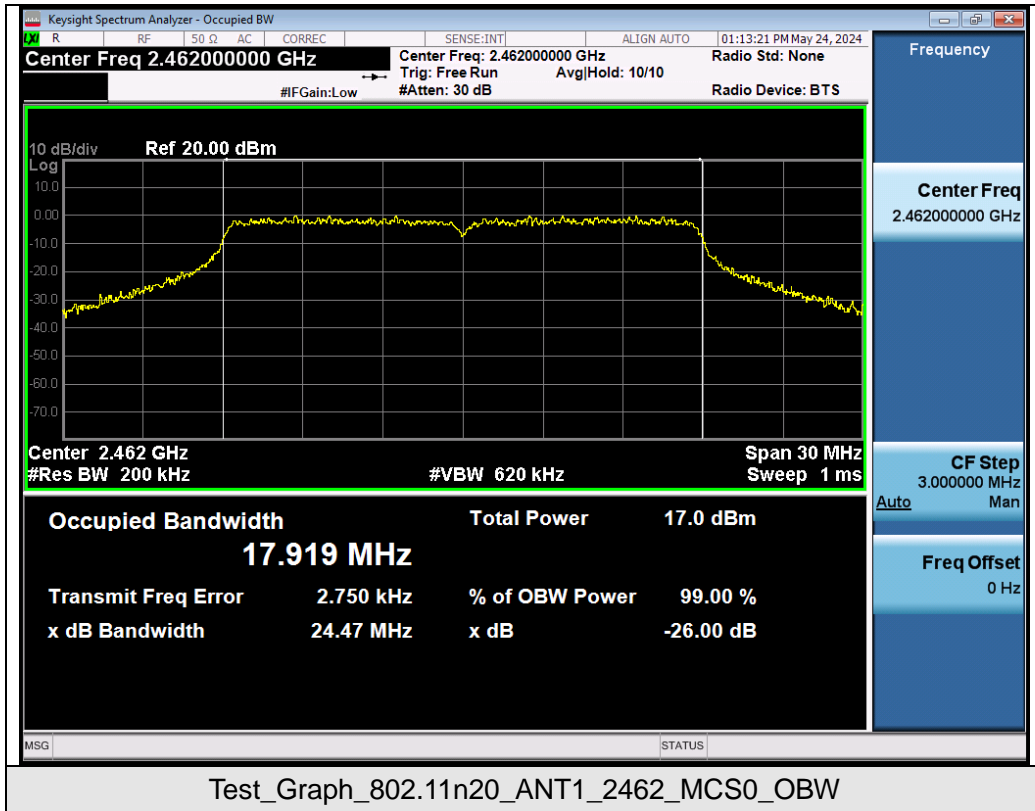

Any report having not been signed by authorized approver, or having been altered without authorization, or having not been stamped by the "Dedicated Testing/Inspection Stamp" is deemed to be invalid. Copying or excerpting portion of, or altering the content of the report is not permitted without the written authorization of AGC. The test results presented in the report apply only to the tested sample. Any objections to report issued by AGC should be submitted to AGC within 15days after the issuance of the test report. Further enquiry of validity or verification of the test report should be addressed to AGC by agc01@agccert.com.

Test Graphs of DTS Bandwidth

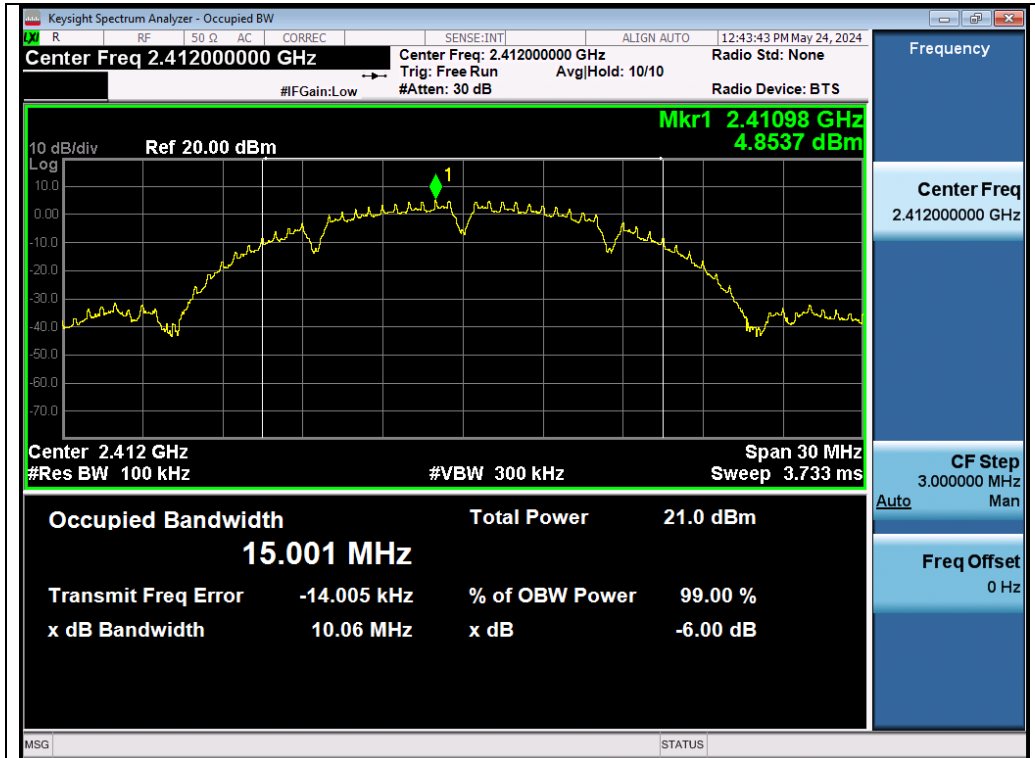

Test_Graph_802.11b_ANT1_2412_1Mbps_DTSBW



Test_Graph_802.11b_ANT1_2437_1Mbps_DTSBW

Any report having not been signed by authorized approver, or having been altered without authorization, or having not been stamped by the "Dedicated Testing/Inspection Stamp" is deemed to be invalid. Copying or excerpting portion of, or altering the content of the report is not permitted without the written authorization of AGC. The test results presented in the report apply only to the tested sample. Any objections to report issued by AGC should be submitted to AGC within 15days after the issuance of the test report. Further enquiry of validity or verification of the test report should be addressed to AGC by agc01@agccert.com.

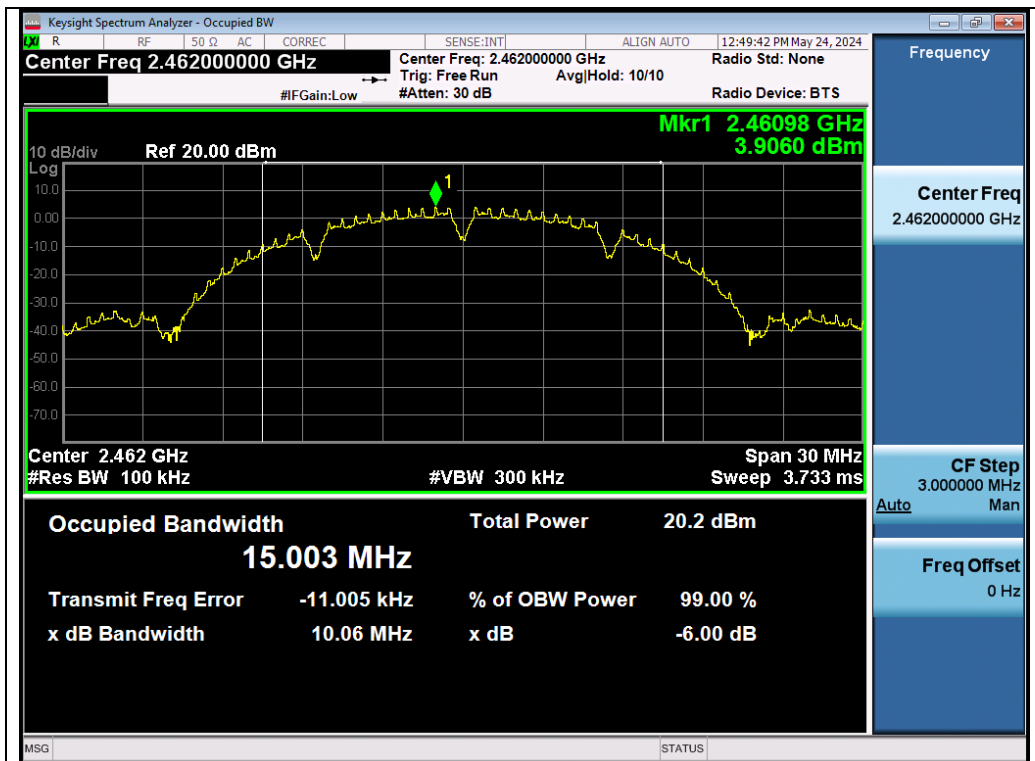

Test_Graph_802.11b_ANT1_2462_1Mbps_DTSBW

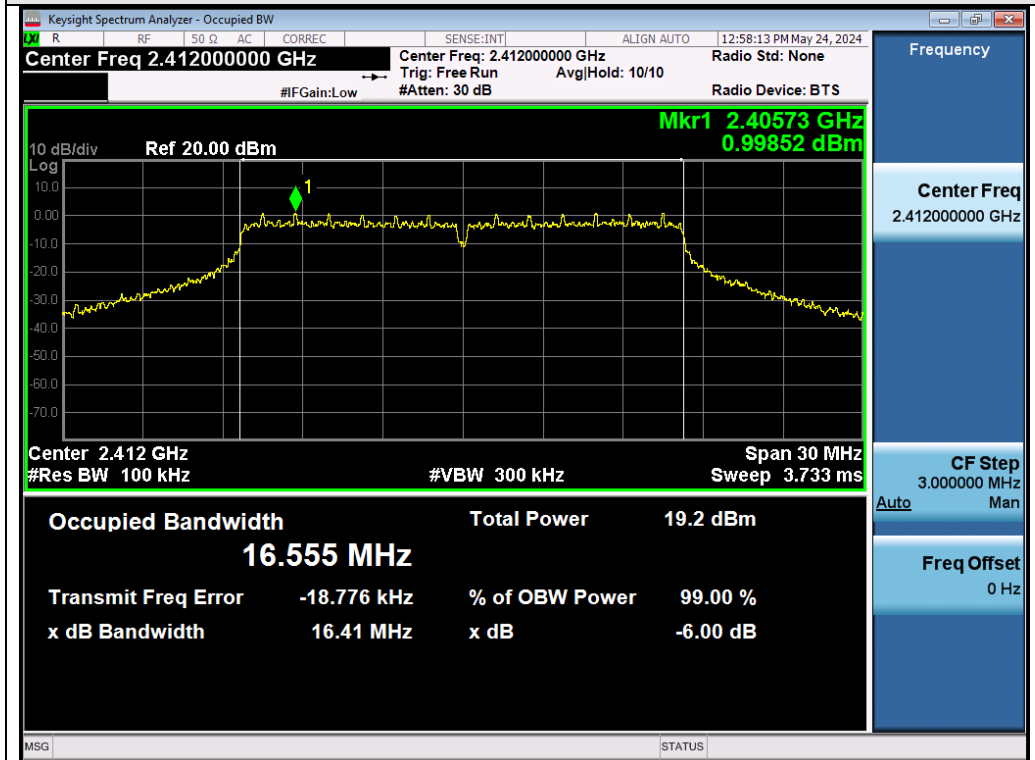

Test_Graph_802.11g_ANT1_2412_6Mbps_DTSBW

Any report having not been signed by authorized approver, or having been altered without authorization, or having not been stamped by the "Dedicated Testing/Inspection Stamp" is deemed to be invalid. Copying or excerpting portion of, or altering the content of the report is not permitted without the written authorization of AGC. The test results presented in the report apply only to the tested sample. Any objections to report issued by AGC should be submitted to AGC within 15days after the issuance of the test report. Further enquiry of validity or verification of the test report should be addressed to AGC by agc01@agccert.com.

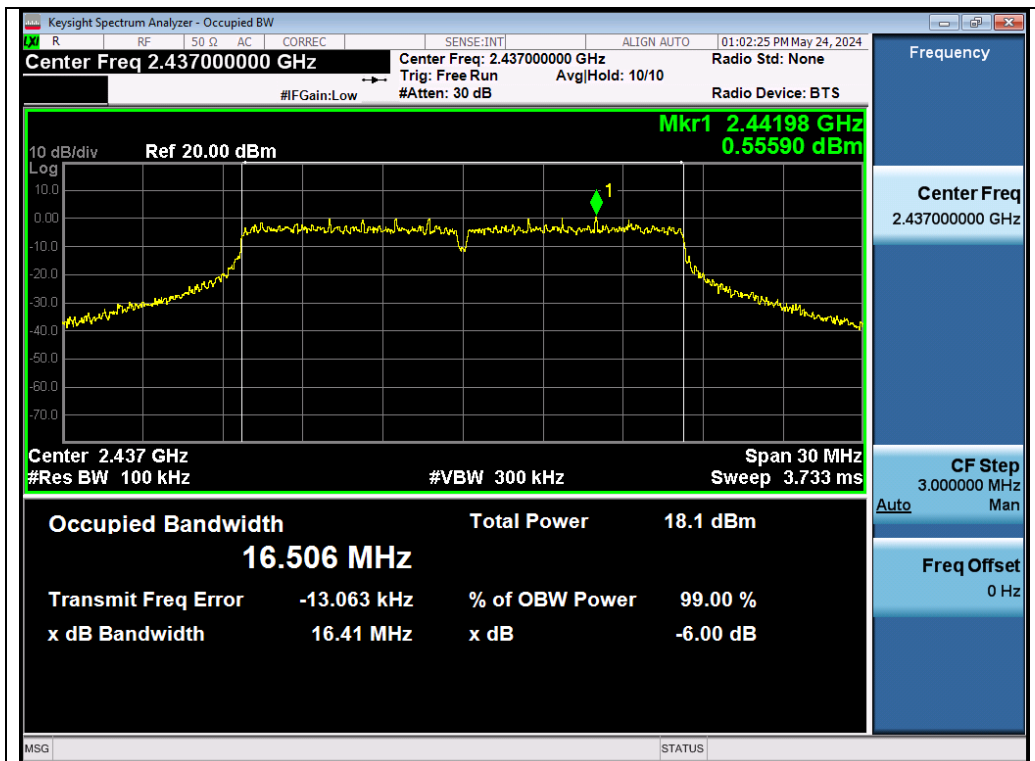

Test_Graph_802.11g_ANT1_2437_6Mbps_DTSBW

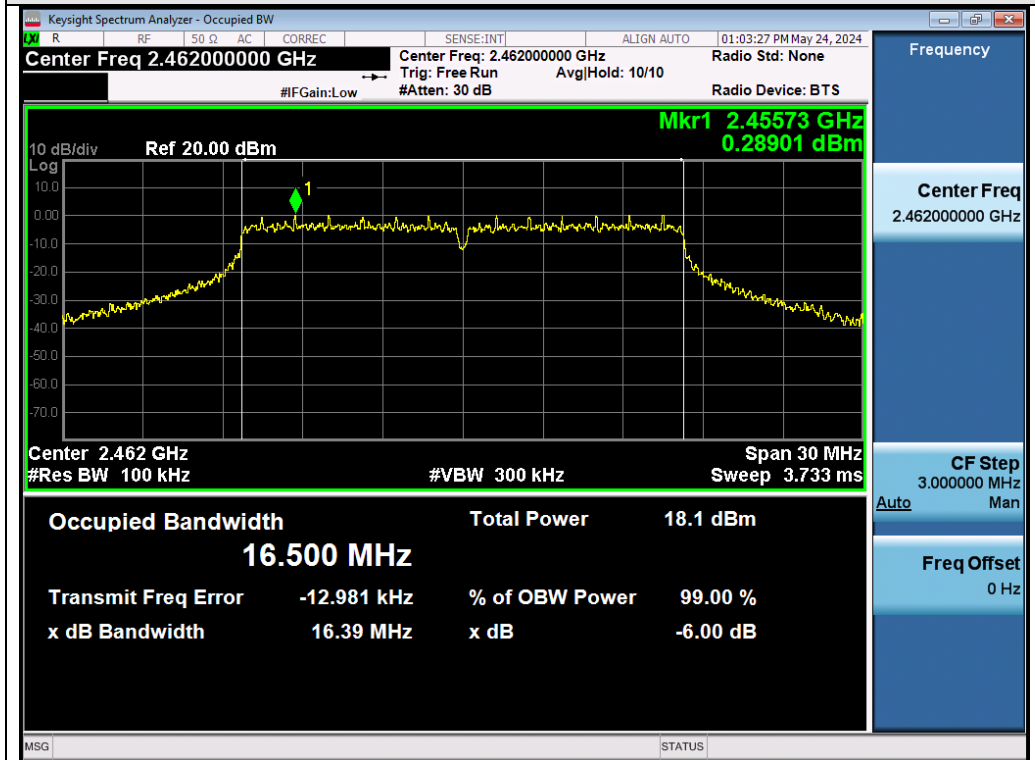

Test_Graph_802.11g_ANT1_2462_6Mbps_DTSBW

Any report having not been signed by authorized approver, or having been altered without authorization, or having not been stamped by the "Dedicated Testing/Inspection Stamp" is deemed to be invalid. Copying or excerpting portion of, or altering the content of the report is not permitted without the written authorization of AGC. The test results presented in the report apply only to the tested sample. Any objections to report issued by AGC should be submitted to AGC within 15days after the issuance of the test report. Further enquiry of validity or verification of the test report should be addressed to AGC by agc01@agccert.com.

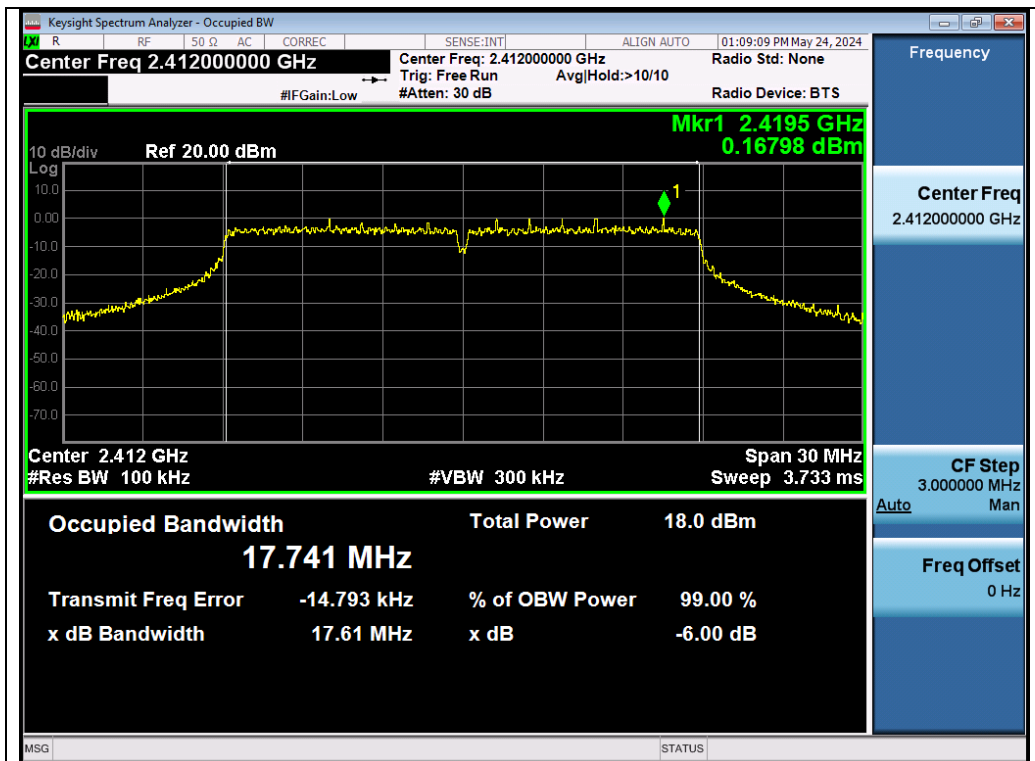

Test_Graph_802.11n20_ANT1_2412_MCS0_DTSBW

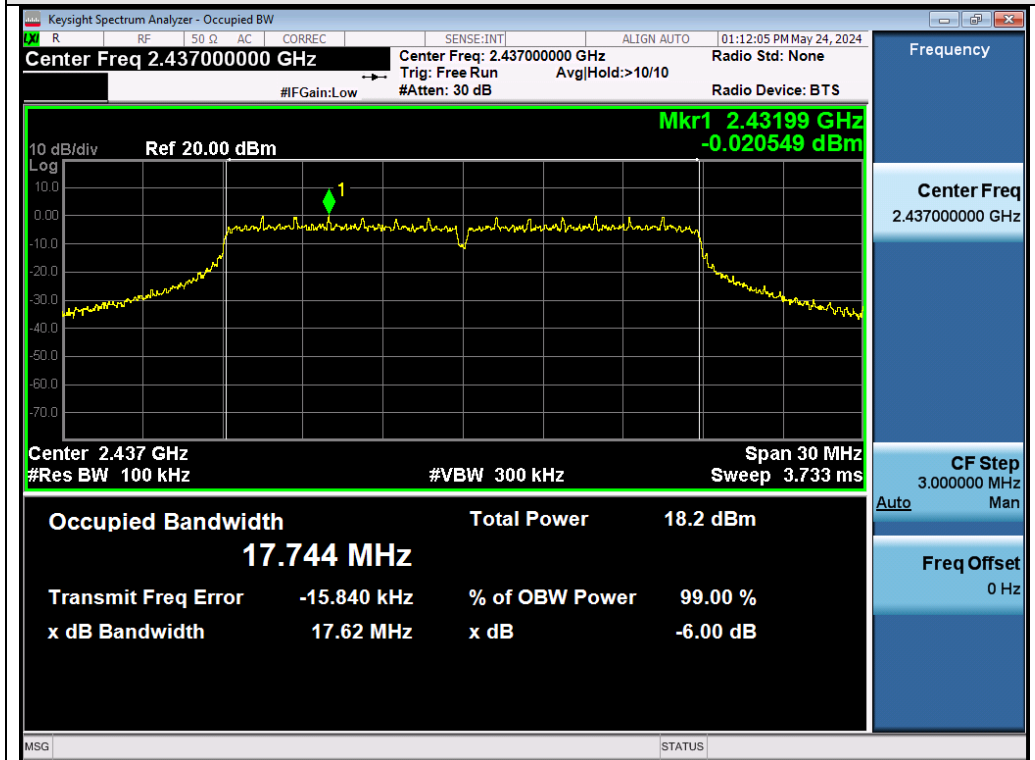

Test_Graph_802.11n20_ANT1_2437_MCS0_DTSBW

Any report having not been signed by authorized approver, or having been altered without authorization, or having not been stamped by the "Dedicated Testing/Inspection Stamp" is deemed to be invalid. Copying or excerpting portion of, or altering the content of the report is not permitted without the written authorization of AGC. The test results presented in the report apply only to the tested sample. Any objections to report issued by AGC should be submitted to AGC within 15days after the issuance of the test report. Further enquiry of validity or verification of the test report should be addressed to AGC by agc01@agccert.com.

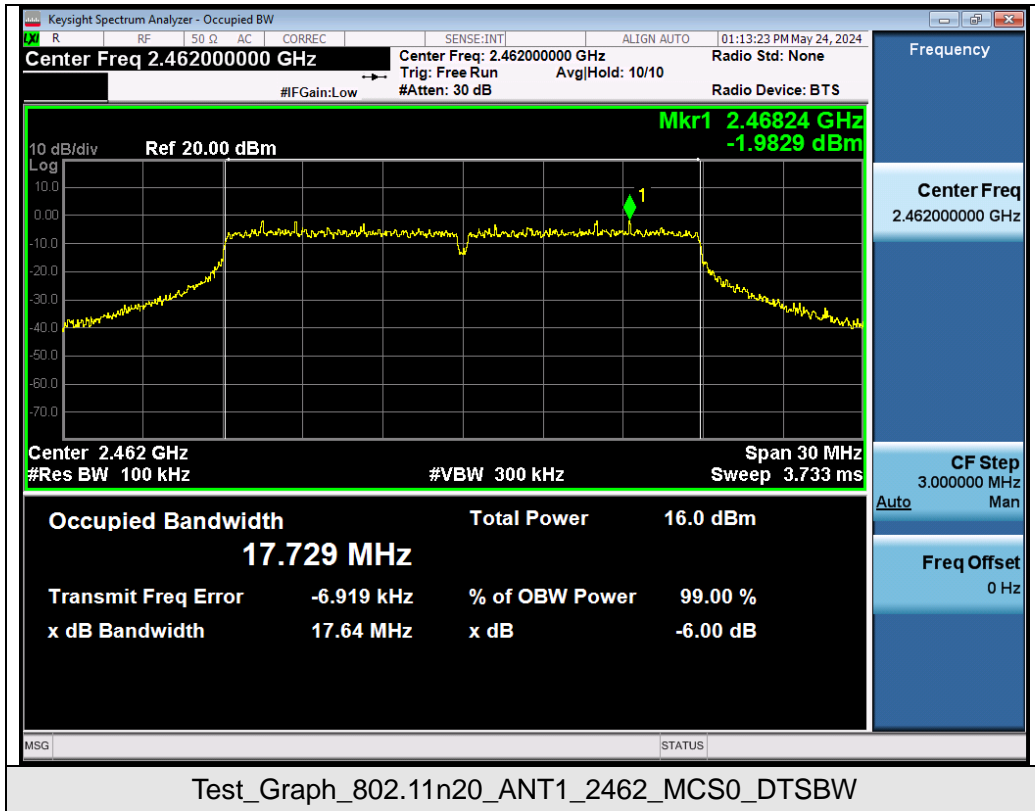

Any report having not been signed by authorized approver, or having been altered without authorization, or having not been stamped by the “Dedicated Testing/Inspection Stamp” is deemed to be invalid. Copying or excerpting portion of, or altering the content of the report is not permitted without the written authorization of AGC. The test results presented in the report apply only to the tested sample. Any objections to report issued by AGC should be submitted to AGC within 15days after the issuance of the test report. Further enquiry of validity or verification of the test report should be addressed to AGC by agc01@agccert.com.

Attestation of Global Compliance(Shenzhen)Co., Ltd
 Attestation of Global Compliance(Shenzhen)Std & Tech Co., Ltd
 Tel: +86-755 2523 4088 E-mail: agc@agccert.com Web: http://www.agccert.com/

9. Power Spectral Density Measurement

9.1 Provisions Applicable

The transmitter power spectral density conducted from the transmitter to the antenna shall not be greater than 8 dBm in any 3 kHz band during any time interval of continuous transmission.

9.2 Measurement Procedure

For Peak power spectral density test:

1. The testing follows the ANSI C63.10 Section 11.10.2 Method PKPSD.
2. Connect EUT RF output port to the Spectrum Analyzer through an RF attenuator
3. Set the RBW = 20 kHz.
4. Set the VBW $\geq [3 \times \text{RBW}]$.
5. Set the Span $\geq [1.5 \times \text{DTS bandwidth}]$.
6. Sweep time=Auto couple.
7. Detector function=Peak.
8. Trace Mode=Max hold.
9. When the measurement bandwidth of Maximum PSD is specified in 3 kHz, add a constant factor $10 \cdot \log(3\text{kHz}/20\text{kHz}) = -8.23 \text{ dB}$ to the measured result.
10. Allow trace to stabilize. Use the marker-to-peak function to set the marker to the peak of the emission.
11. The indicated level is the peak output power, after any corrections for external attenuators and cables.

For Average power spectral density test:

1. The testing follows the ANSI C63.10 Section 11.10.5 Method AVPSD.
2. Connect EUT RF output port to the Spectrum Analyzer through an RF attenuator.
3. Set Span to at least 1.5 times the OBW.
4. Set RBW to: $3 \text{ kHz} \leq \text{RBW} \leq 100 \text{ kHz}$.
5. Set $\text{VBW} \geq [3 \times \text{RBW}]$.
6. Sweep Time=Auto couple.
7. Detector function=RMS (i.e., power averaging).
8. Trace average at least 100 traces in power averaging (rms) mode.
9. When the measurement bandwidth of Maximum PSD is specified in 3 kHz, add a constant factor $10 \cdot \log(3\text{kHz}/20\text{kHz}) = -8.23 \text{ dB}$ to the measured result.
10. Determine according to the duty cycle of the equipment: when it is less than 98%, follow the steps below.
11. Add $[10 \log (1 / D)]$, where D is the duty cycle, to the measured power to compute the average power during the actual transmission times (because the measurement represents an average over both the ON and OFF times of the transmission). For example, add $[10 \log (1/0.25)] = 6 \text{ dB}$ if the duty cycle is 25%.
12. Record the test results in the report.

Any report having not been signed by authorized approver, or having been altered without authorization, or having not been stamped by the "Dedicated Testing/Inspection Stamp" is deemed to be invalid. Copying or excerpting portion of, or altering the content of the report is not permitted without the written authorization of AGC. The test results presented in the report apply only to the tested sample. Any objections to report issued by AGC should be submitted to AGC within 15 days after the issuance of the test report. Further enquiry of validity or verification of the test report should be addressed to AGC by agc01@agccert.com.

9.3 Measurement Setup (Block Diagram of Configuration)

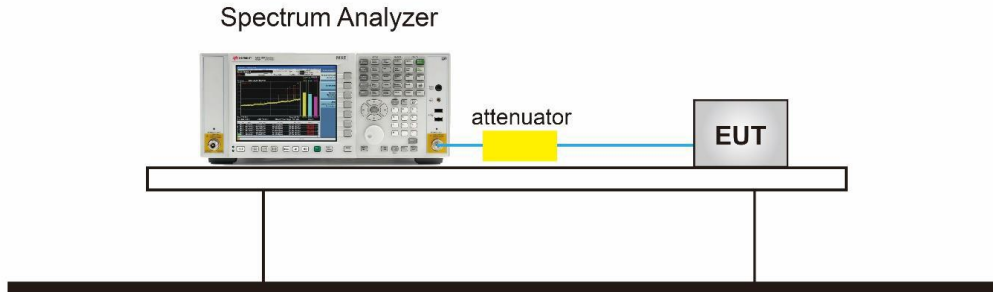

9.4 Measurement Result

| Test Data of Conducted Output Power Spectral Density | | | | | |
|--|----------------------|------------------------------------|-----------------------------------|------------------|--------------|
| Test Mode | Test Frequency (MHz) | Power Spectral density (dBm/20kHz) | Power Spectral density (dBm/3kHz) | Limit (dBm/3kHz) | Pass or Fail |
| 802.11b | 2412 | -0.266 | -8.505 | ≤8 | Pass |
| | 2437 | -0.611 | -8.85 | ≤8 | Pass |
| | 2462 | -1.191 | -9.43 | ≤8 | Pass |
| 802.11g | 2412 | -4.081 | -12.32 | ≤8 | Pass |
| | 2437 | -4.411 | -12.65 | ≤8 | Pass |
| | 2462 | -4.199 | -12.438 | ≤8 | Pass |
| 802.11n20 | 2412 | -4.637 | -12.876 | ≤8 | Pass |
| | 2437 | -5.209 | -13.448 | ≤8 | Pass |
| | 2462 | -6.492 | -14.731 | ≤8 | Pass |

Any report having not been signed by authorized approver, or having been altered without authorization, or having not been stamped by the “Dedicated Testing/Inspection Stamp” is deemed to be invalid. Copying or excerpting portion of, or altering the content of the report is not permitted without the written authorization of AGC. The test results presented in the report apply only to the tested sample. Any objections to report issued by AGC should be submitted to AGC within 15days after the issuance of the test report. Further enquiry of validity or verification of the test report should be addressed to AGC by agc01@agccert.com.

Test Graphs of Conducted Output Power Spectral Density



Test_Graph_802.11b_ANT1_2412_1Mbps_PSD



Test_Graph_802.11b_ANT1_2437_1Mbps_PSD

Any report having not been signed by authorized approver, or having been altered without authorization, or having not been stamped by the "Dedicated Testing/Inspection Stamp" is deemed to be invalid. Copying or excerpting portion of, or altering the content of the report is not permitted without the written authorization of AGC. The test results presented in the report apply only to the tested sample. Any objections to report issued by AGC should be submitted to AGC within 15days after the issuance of the test report. Further enquiry of validity or verification of the test report should be addressed to AGC by agc01@agccert.com.



Test_Graph_802.11b_ANT1_2462_1Mbps_PSD

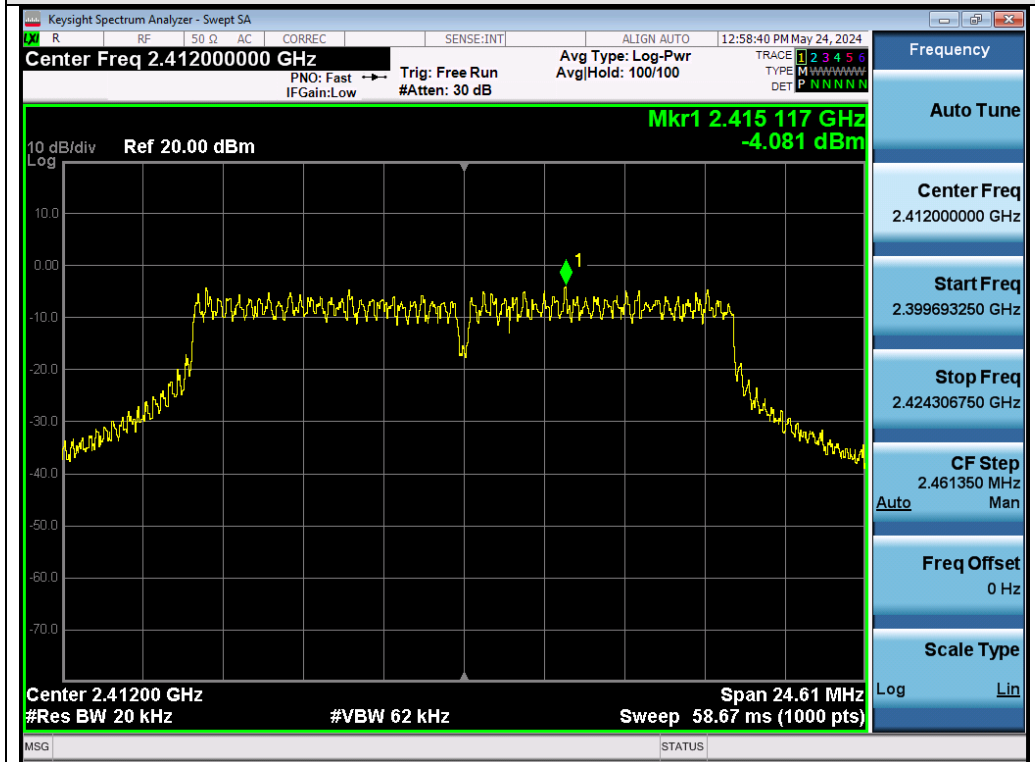

Test_Graph_802.11g_ANT1_2412_6Mbps_PSD

Any report having not been signed by authorized approver, or having been altered without authorization, or having not been stamped by the "Dedicated Testing/Inspection Stamp" is deemed to be invalid. Copying or excerpting portion of, or altering the content of the report is not permitted without the written authorization of AGC. The test results presented in the report apply only to the tested sample. Any objections to report issued by AGC should be submitted to AGC within 15days after the issuance of the test report. Further enquiry of validity or verification of the test report should be addressed to AGC by agc01@agccert.com.

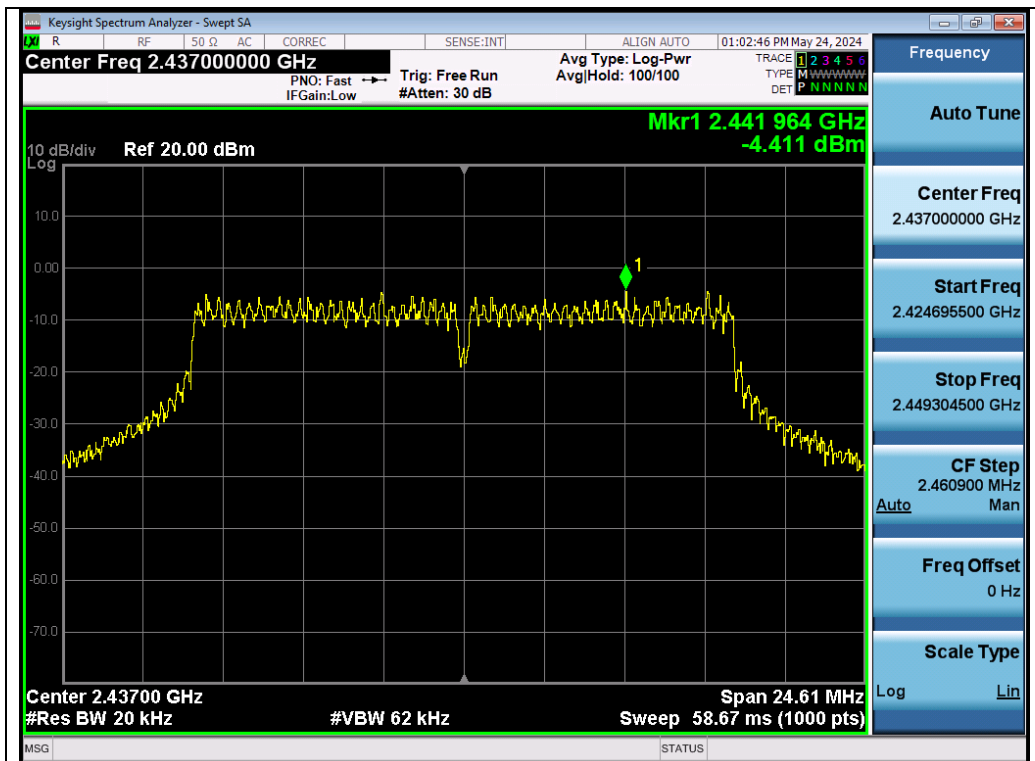

Test_Graph_802.11g_ANT1_2437_6Mbps_PSD

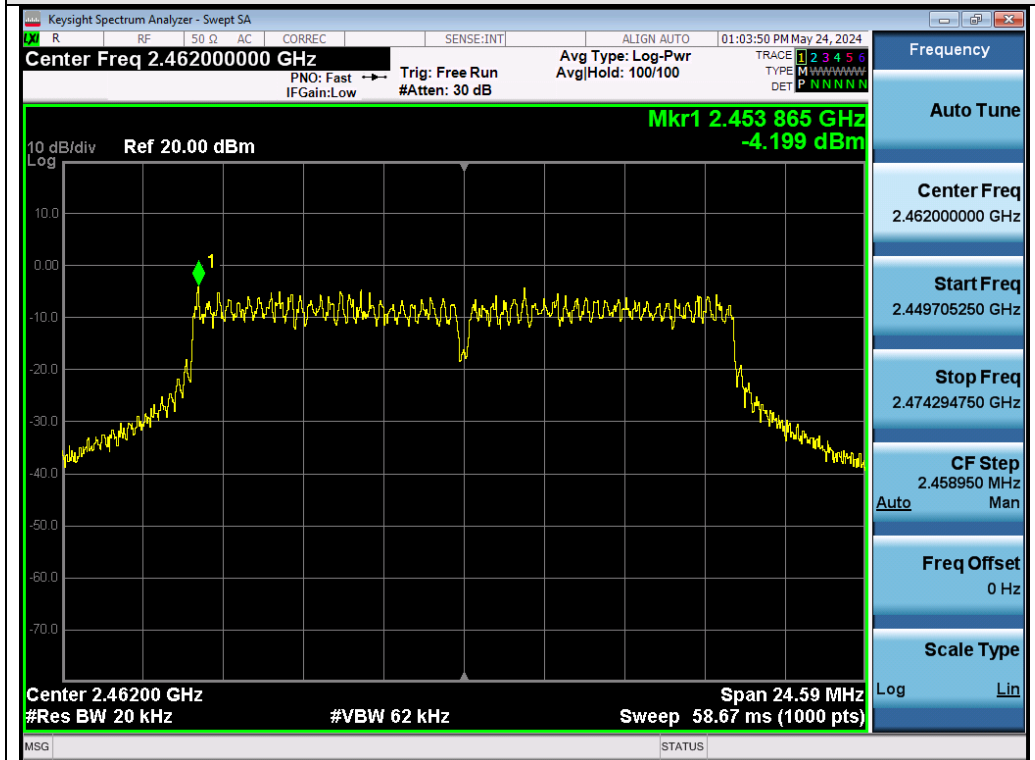

Test_Graph_802.11g_ANT1_2462_6Mbps_PSD

Any report having not been signed by authorized approver, or having been altered without authorization, or having not been stamped by the "Dedicated Testing/Inspection Stamp" is deemed to be invalid. Copying or excerpting portion of, or altering the content of the report is not permitted without the written authorization of AGC. The test results presented in the report apply only to the tested sample. Any objections to report issued by AGC should be submitted to AGC within 15days after the issuance of the test report. Further enquiry of validity or verification of the test report should be addressed to AGC by agc01@agccert.com.

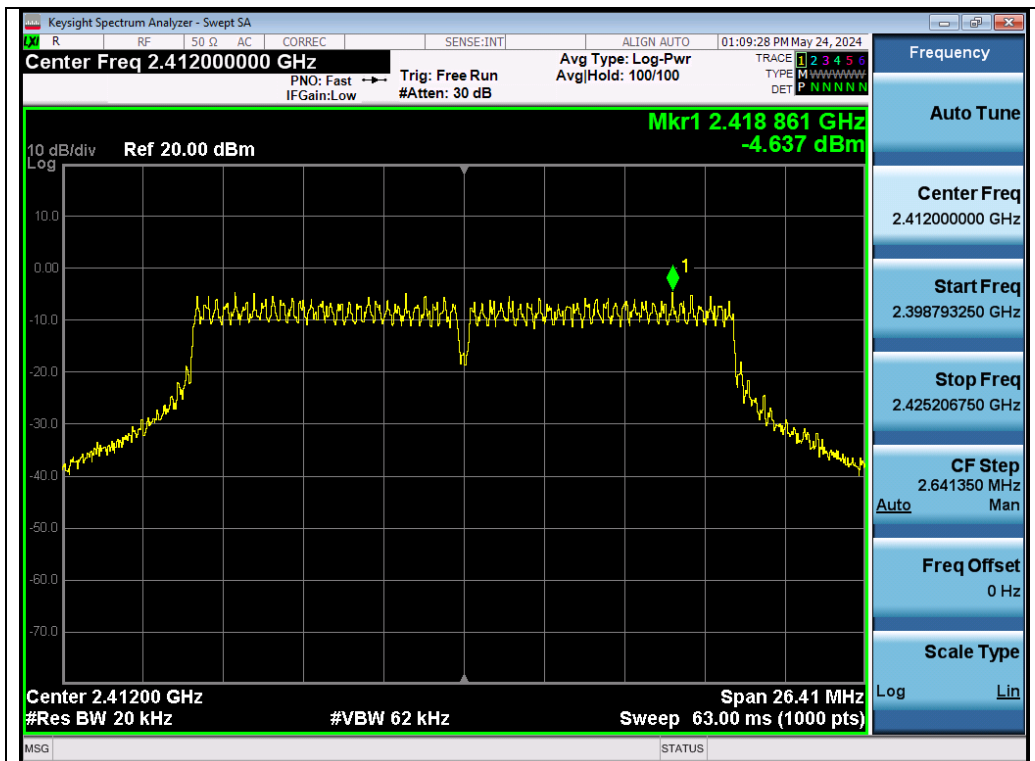

Test_Graph_802.11n20_ANT1_2412_MCS0_PSD

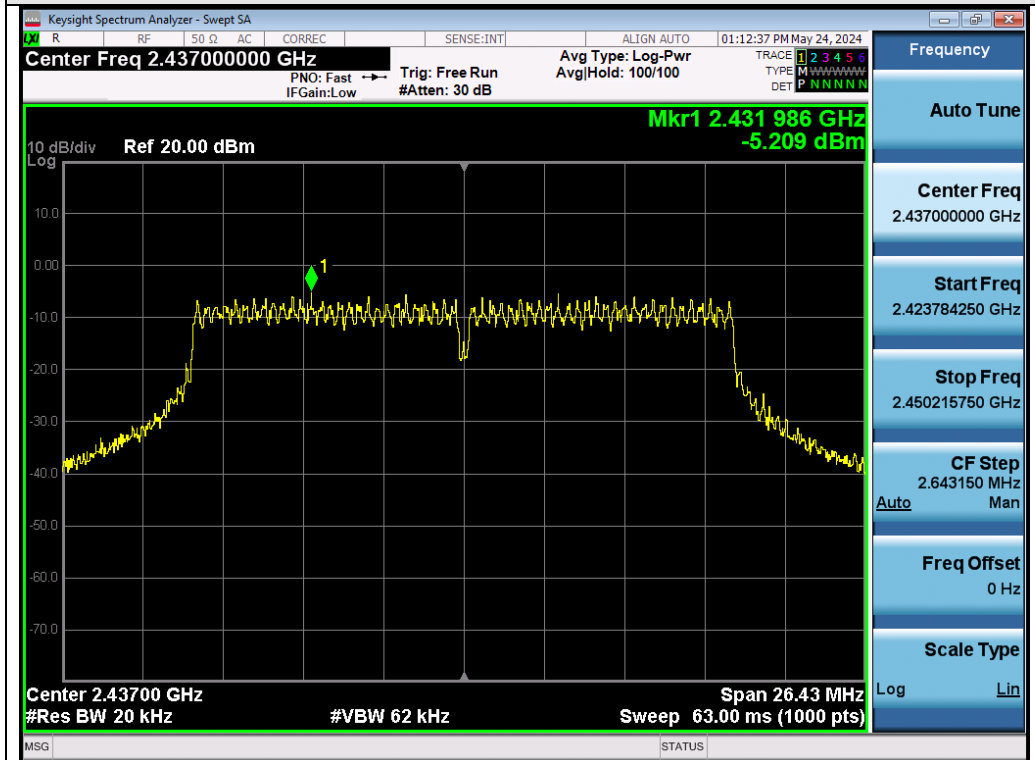

Test_Graph_802.11n20_ANT1_2437_MCS0_PSD

Any report having not been signed by authorized approver, or having been altered without authorization, or having not been stamped by the "Dedicated Testing/Inspection Stamp" is deemed to be invalid. Copying or excerpting portion of, or altering the content of the report is not permitted without the written authorization of AGC. The test results presented in the report apply only to the tested sample. Any objections to report issued by AGC should be submitted to AGC within 15days after the issuance of the test report. Further enquiry of validity or verification of the test report should be addressed to AGC by agc01@agccert.com.

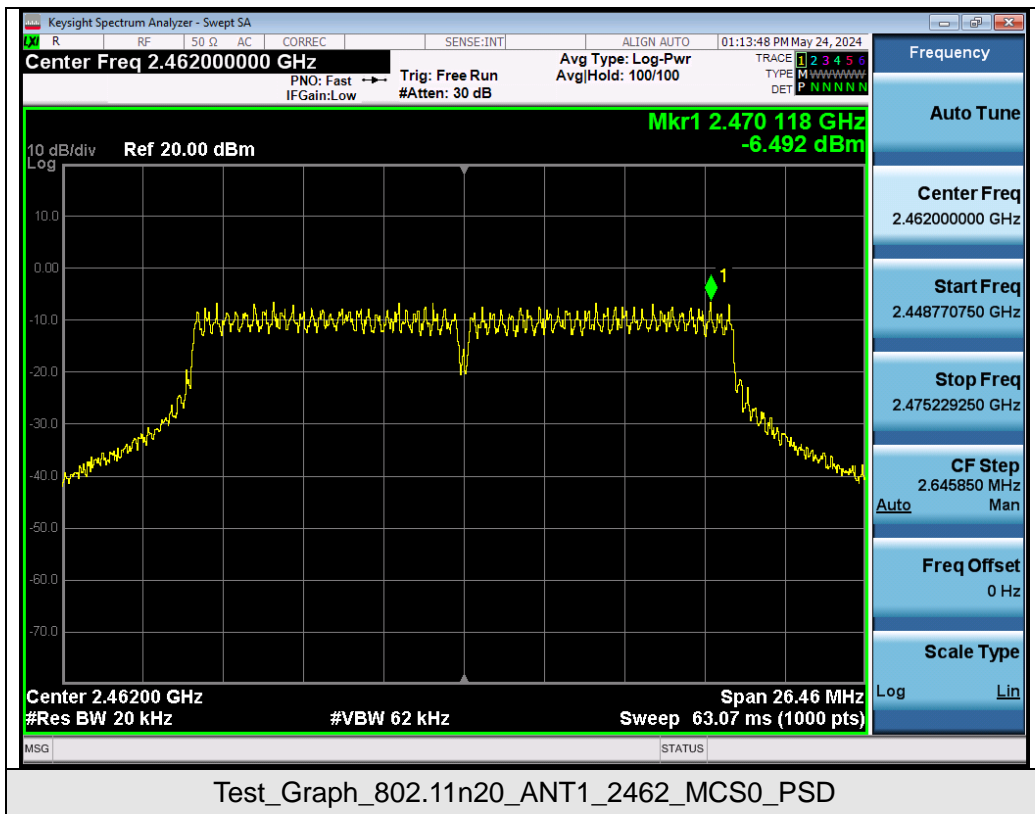

Any report having not been signed by authorized approver, or having been altered without authorization, or having not been stamped by the "Dedicated Testing/Inspection Stamp" is deemed to be invalid. Copying or excerpting portion of, or altering the content of the report is not permitted without the written authorization of AGC. The test results presented in the report apply only to the tested sample. Any objections to report issued by AGC should be submitted to AGC within 15days after the issuance of the test report. Further enquiry of validity or verification of the test report should be addressed to AGC by agc01@agccert.com.

Attestation of Global Compliance(Shenzhen)Co., Ltd
Attestation of Global Compliance(Shenzhen)Std & Tech Co., Ltd
Tel: +86-755 2523 4088 E-mail: agc@agccert.com Web: http://www.agccert.com/

10. Conducted Band Edge and Out-of-Band Emissions

10.1 Provisions Applicable

In any 100kHz bandwidth outside the frequency bands in which the spread spectrum intentional radiator is operating, the radio frequency power that is produced by the intentional radiator shall be at least 20dB below that in the 100kHz bandwidth within the band that contains the highest level of the desired power.

10.2 Measurement Procedure

Remove the antenna from the EUT and then connect a low loss RF cable from the antenna port to the spectrum analyzer.

Use the following spectrum analyzer settings:

- Step 1: Measurement Procedure In-Band Reference Level
 1. Set instrument center frequency to DTS channel center frequency.
 2. Set the span to ≥ 1.5 times the DTS bandwidth.
 3. Set the RBW = 100 kHz.
 4. Set the VBW $\geq 3 \times$ RBW.
 5. Detector = peak.
 6. Sweep time = auto couple.
 7. Trace mode = max hold.
 8. Allow trace to fully stabilize.
 9. Use the peak marker function to determine the maximum PSD level.
 10. Note that the channel found to contain the maximum PSD level can be used to establish the reference level.
- Step 2: Measurement Procedure Out of Band Emission
 1. Set RBW = 100 kHz.
 2. Set VBW ≥ 300 kHz.
 3. Detector = peak.
 4. Sweep = auto couple.
 5. Trace Mode = max hold.
 6. Allow trace to fully stabilize.
 7. Use the peak marker function to determine the maximum amplitude level.

Note: The cable loss and attenuator loss were offset into measure device as an amplitude offset.

10.3 Measurement Setup (Block Diagram of Configuration)

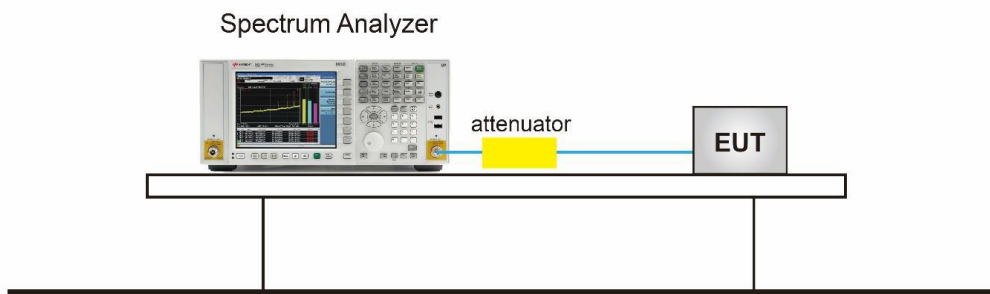

Any report having not been signed by authorized approver, or having been altered without authorization, or having not been stamped by the "Dedicated Testing/Inspection Stamp" is deemed to be invalid. Copying or excerpting portion of, or altering the content of the report is not permitted without the written authorization of AGC. The test results presented in the report apply only to the tested sample. Any objections to report issued by AGC should be submitted to AGC within 15days after the issuance of the test report. Further enquiry of validity or verification of the test report should be addressed to AGC by agc01@agccert.com.

10.4 Measurement Result

Test Graphs of Spurious Emissions in Non-Restricted Frequency Bands

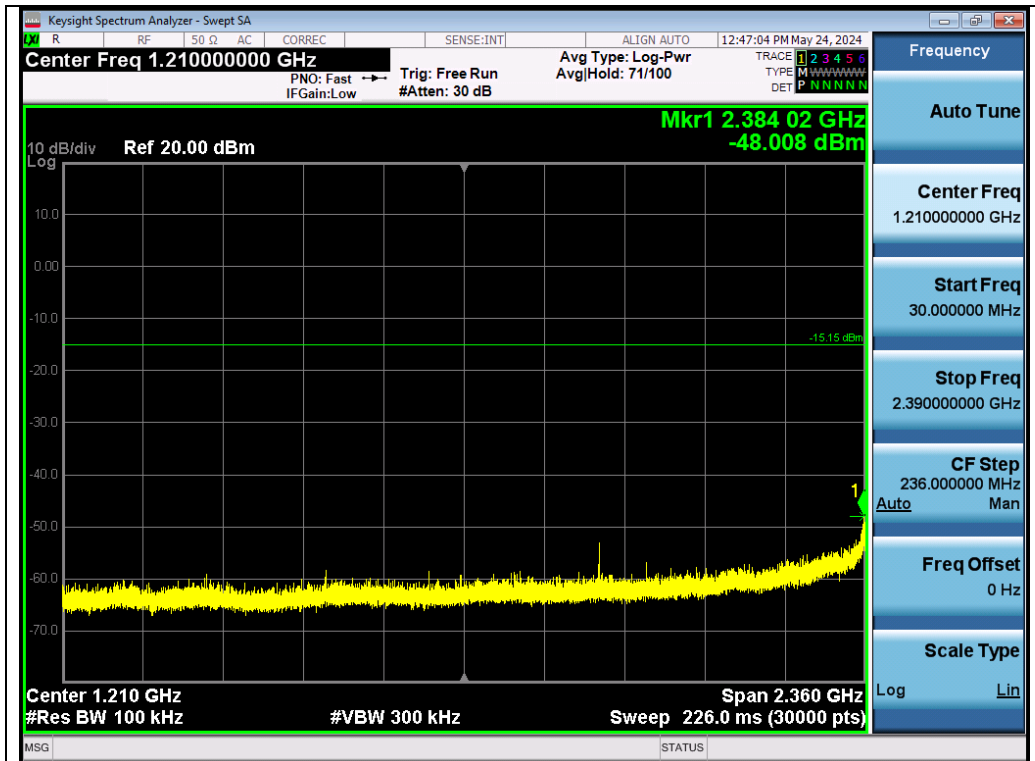

Test_Graph_802.11b_ANT1_2412_1Mbps_Lower Band Emissions

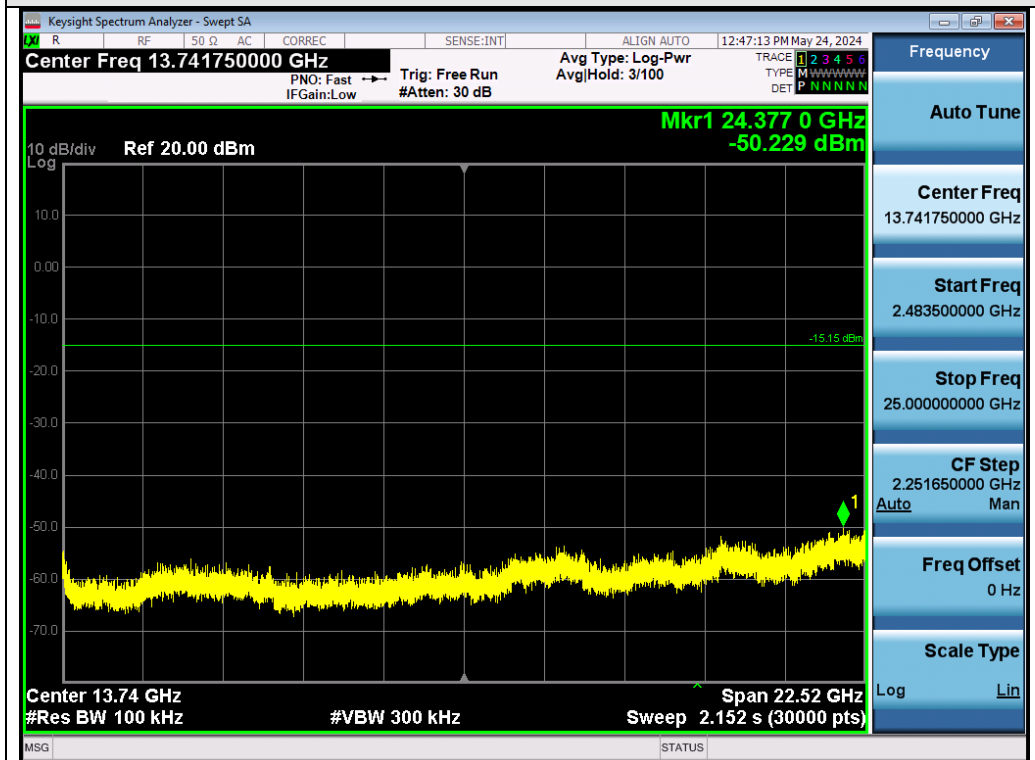

Test_Graph_802.11b_ANT1_2412_1Mbps_Higher Band Emissions

Any report having not been signed by authorized approver, or having been altered without authorization, or having not been stamped by the "Dedicated Testing/Inspection Stamp" is deemed to be invalid. Copying or excerpting portion of, or altering the content of the report is not permitted without the written authorization of AGC. The test results presented in the report apply only to the tested sample. Any objections to report issued by AGC should be submitted to AGC within 15days after the issuance of the test report. Further enquiry of validity or verification of the test report should be addressed to AGC by agc01@agccert.com.

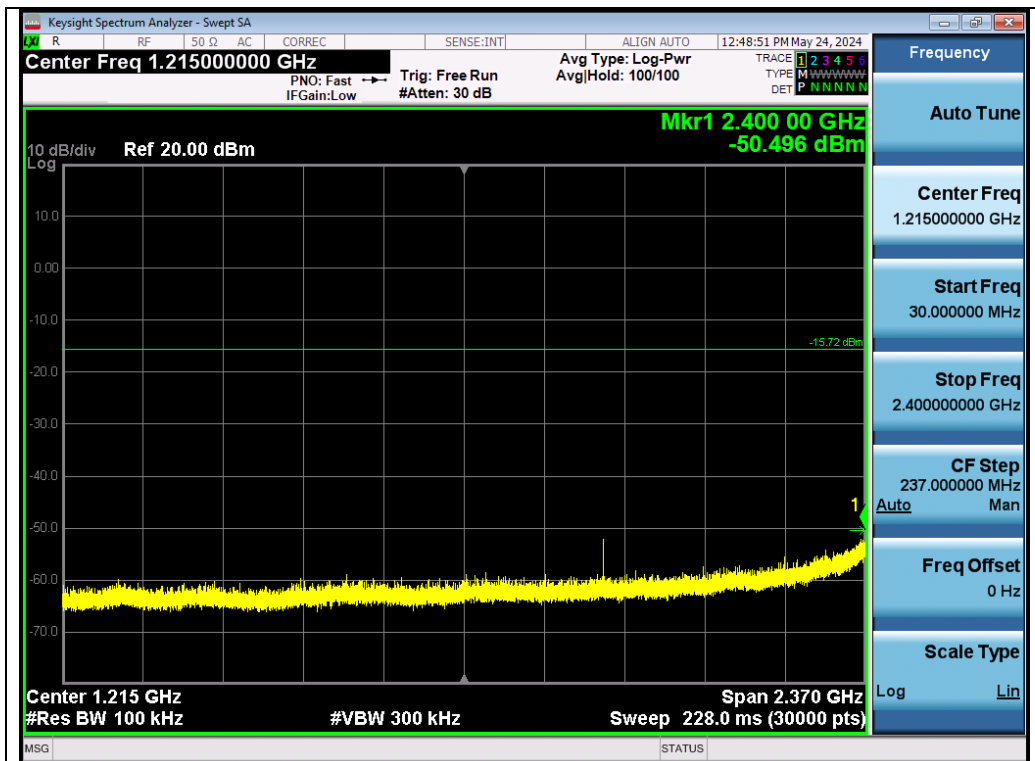

Test_Graph_802.11b_ANT1_2437_1Mbps_Lower Band Emissions

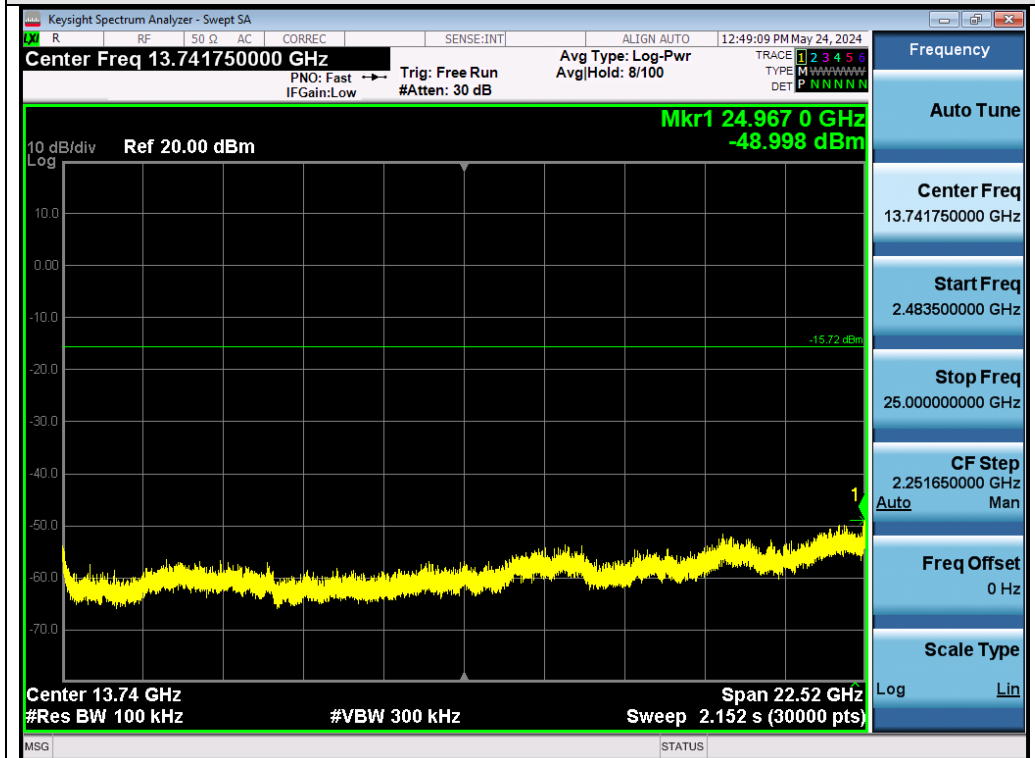

Test_Graph_802.11b_ANT1_2437_1Mbps_Higher Band Emissions

Any report having not been signed by authorized approver, or having been altered without authorization, or having not been stamped by the "Dedicated Testing/Inspection Stamp" is deemed to be invalid. Copying or excerpting portion of, or altering the content of the report is not permitted without the written authorization of AGC. The test results presented in the report apply only to the tested sample. Any objections to report issued by AGC should be submitted to AGC within 15days after the issuance of the test report. Further enquiry of validity or verification of the test report should be addressed to AGC by agc01@agccert.com.

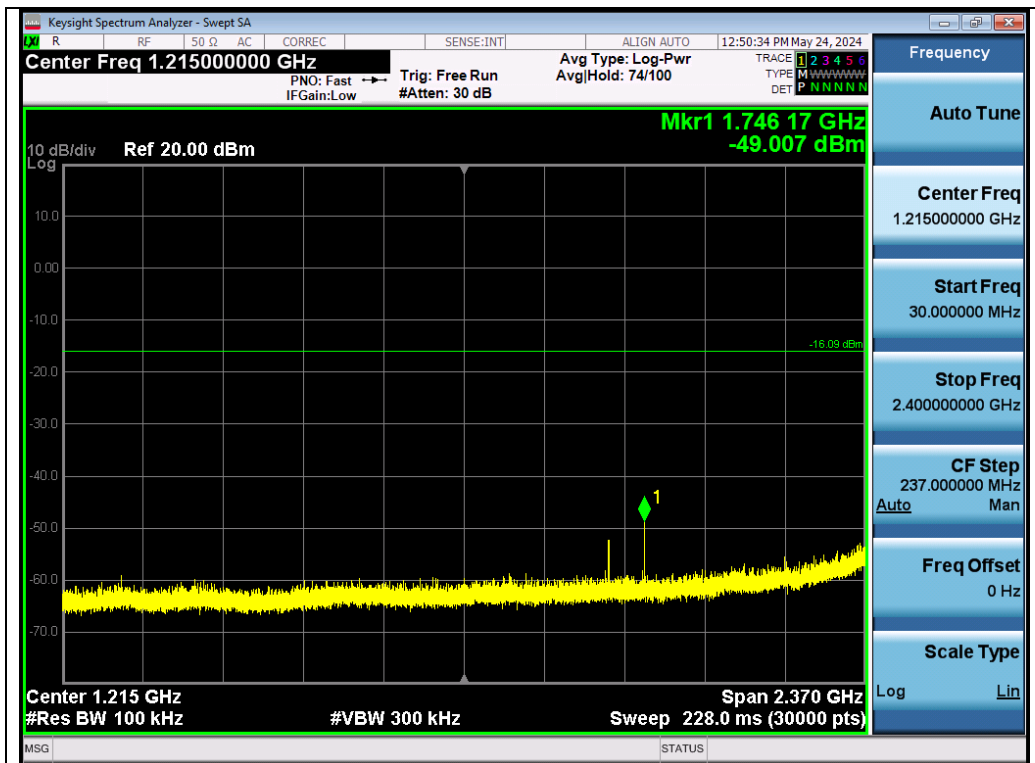

Test_Graph_802.11b_ANT1_2462_1Mbps_Lower Band Emissions

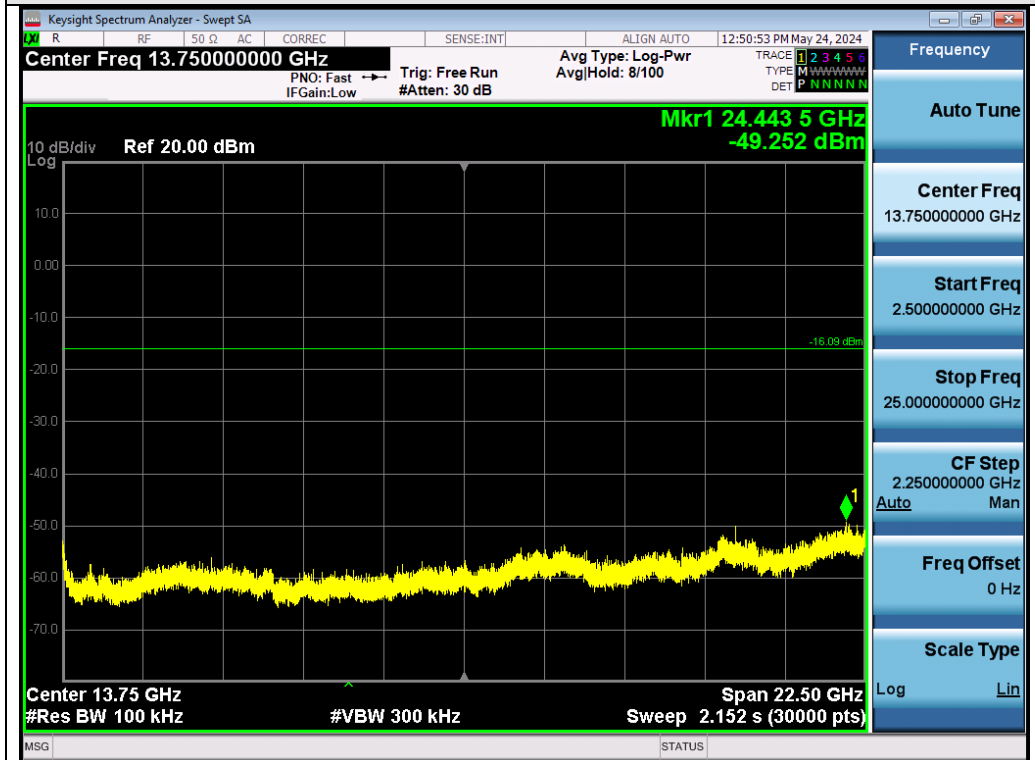

Test_Graph_802.11b_ANT1_2462_1Mbps_Higher Band Emissions

Any report having not been signed by authorized approver, or having been altered without authorization, or having not been stamped by the "Dedicated Testing/Inspection Stamp" is deemed to be invalid. Copying or excerpting portion of, or altering the content of the report is not permitted without the written authorization of AGC. The test results presented in the report apply only to the tested sample. Any objections to report issued by AGC should be submitted to AGC within 15days after the issuance of the test report. Further enquiry of validity or verification of the test report should be addressed to AGC by agc01@agccert.com.

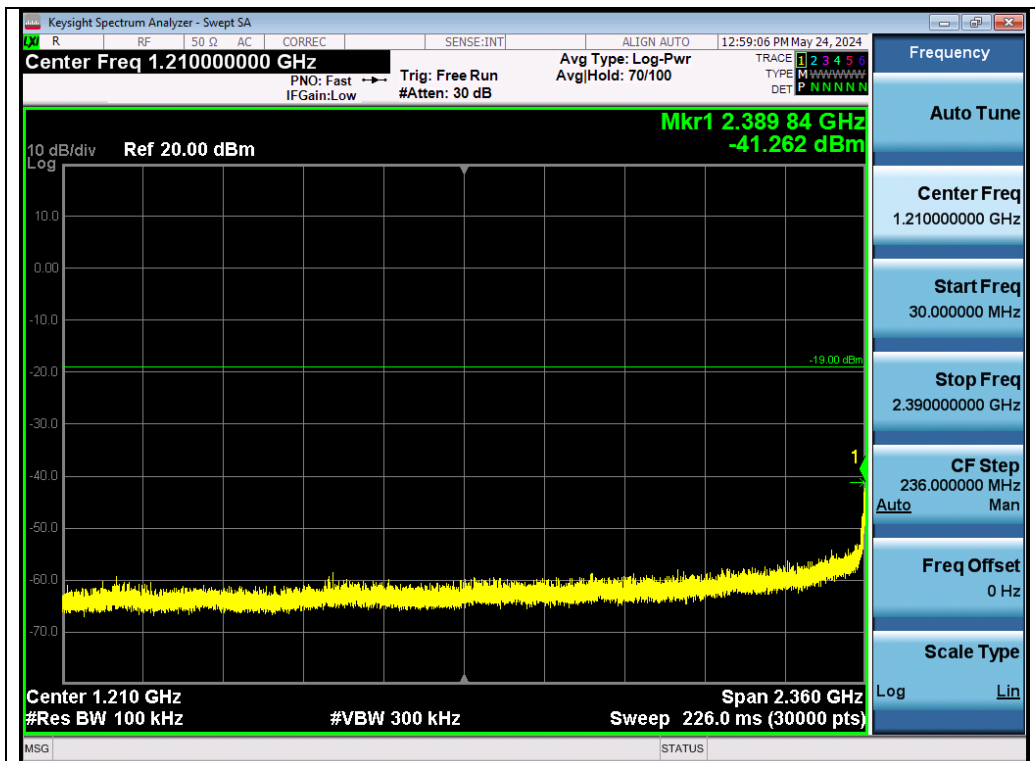

Test_Graph_802.11g_ANT1_2412_6Mbps_Lower Band Emissions

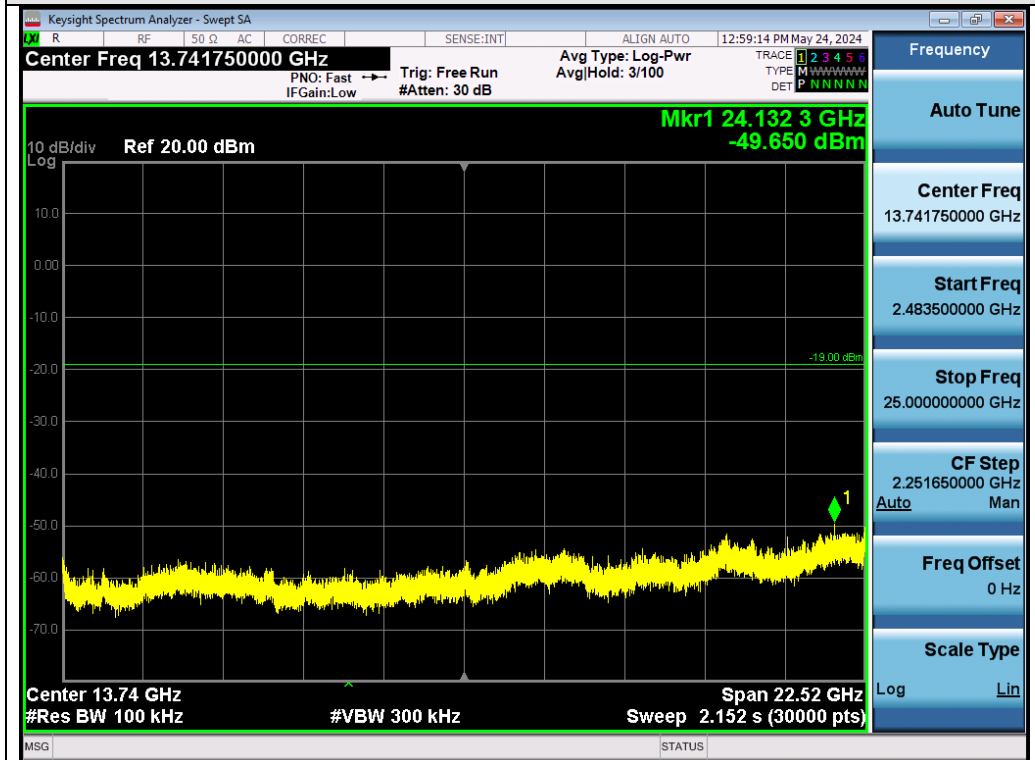

Test_Graph_802.11g_ANT1_2412_6Mbps_Higher Band Emissions

Any report having not been signed by authorized approver, or having been altered without authorization, or having not been stamped by the "Dedicated Testing/Inspection Stamp" is deemed to be invalid. Copying or excerpting portion of, or altering the content of the report is not permitted without the written authorization of AGC. The test results presented in the report apply only to the tested sample. Any objections to report issued by AGC should be submitted to AGC within 15days after the issuance of the test report. Further enquiry of validity or verification of the test report should be addressed to AGC by agc01@agccert.com.

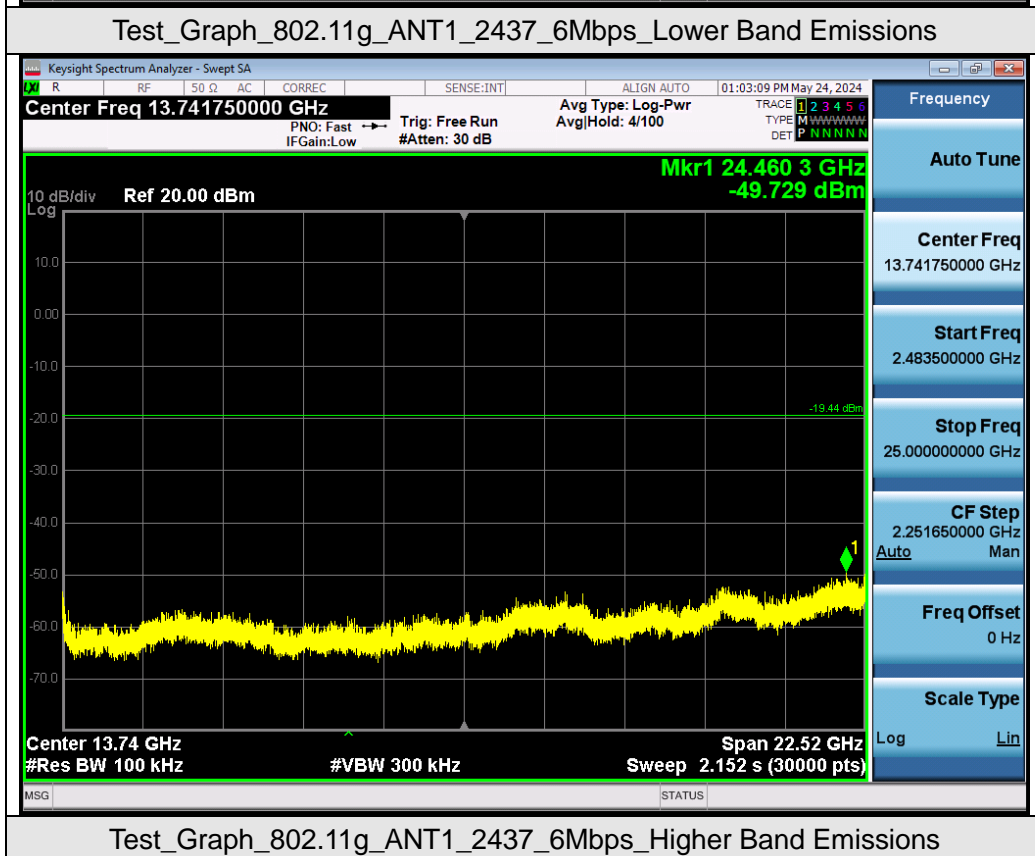
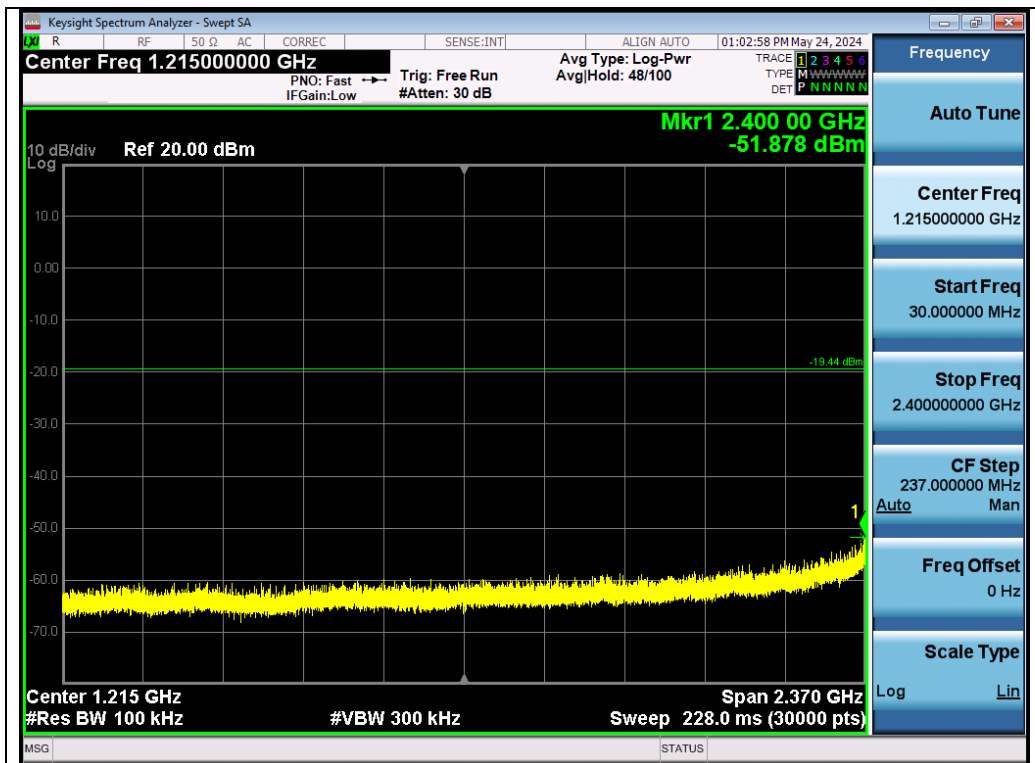

Any report having not been signed by authorized approver, or having been altered without authorization, or having not been stamped by the "Dedicated Testing/Inspection Stamp" is deemed to be invalid. Copying or excerpting portion of, or altering the content of the report is not permitted without the written authorization of AGC. The test results presented in the report apply only to the tested sample. Any objections to report issued by AGC should be submitted to AGC within 15days after the issuance of the test report. Further enquiry of validity or verification of the test report should be addressed to AGC by agc01@agccert.com.

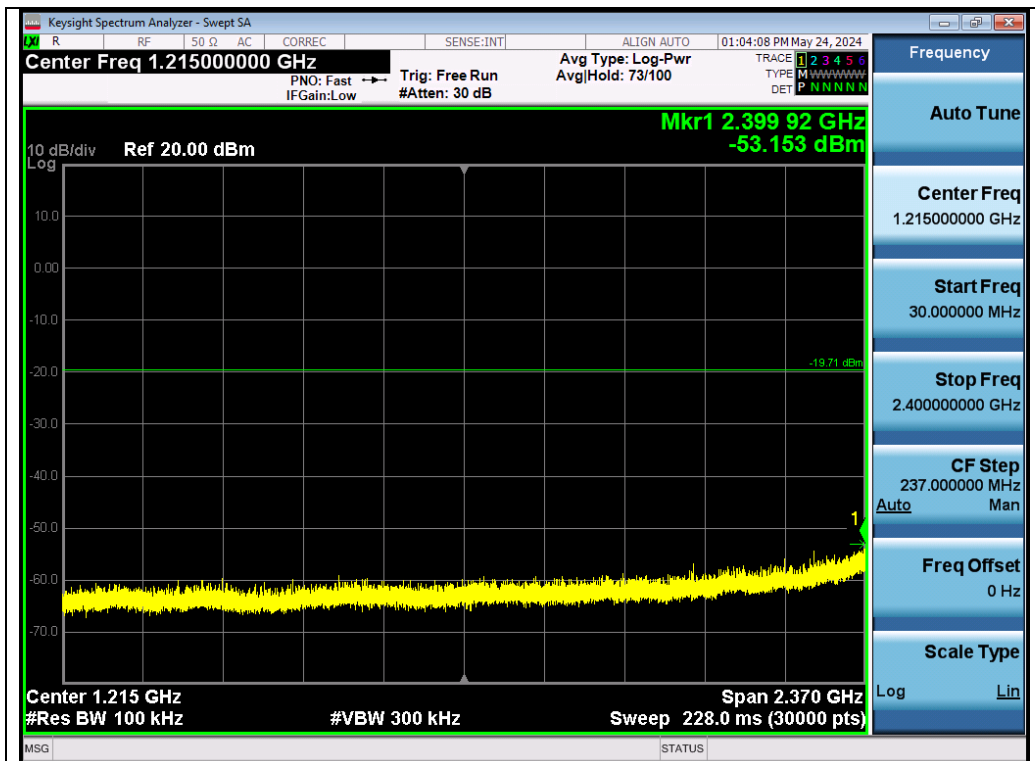

Test_Graph_802.11g_ANT1_2462_6Mbps_Lower Band Emissions

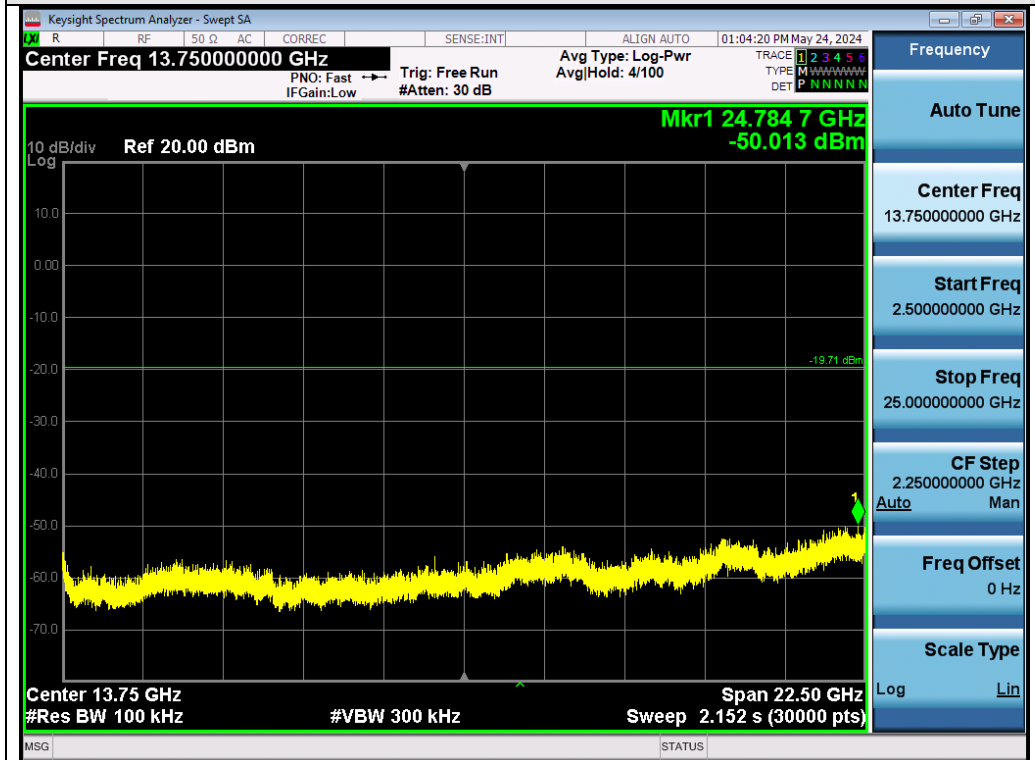

Test_Graph_802.11g_ANT1_2462_6Mbps_Higher Band Emissions

Any report having not been signed by authorized approver, or having been altered without authorization, or having not been stamped by the "Dedicated Testing/Inspection Stamp" is deemed to be invalid. Copying or excerpting portion of, or altering the content of the report is not permitted without the written authorization of AGC. The test results presented in the report apply only to the tested sample. Any objections to report issued by AGC should be submitted to AGC within 15days after the issuance of the test report. Further enquiry of validity or verification of the test report should be addressed to AGC by agc01@agccert.com.

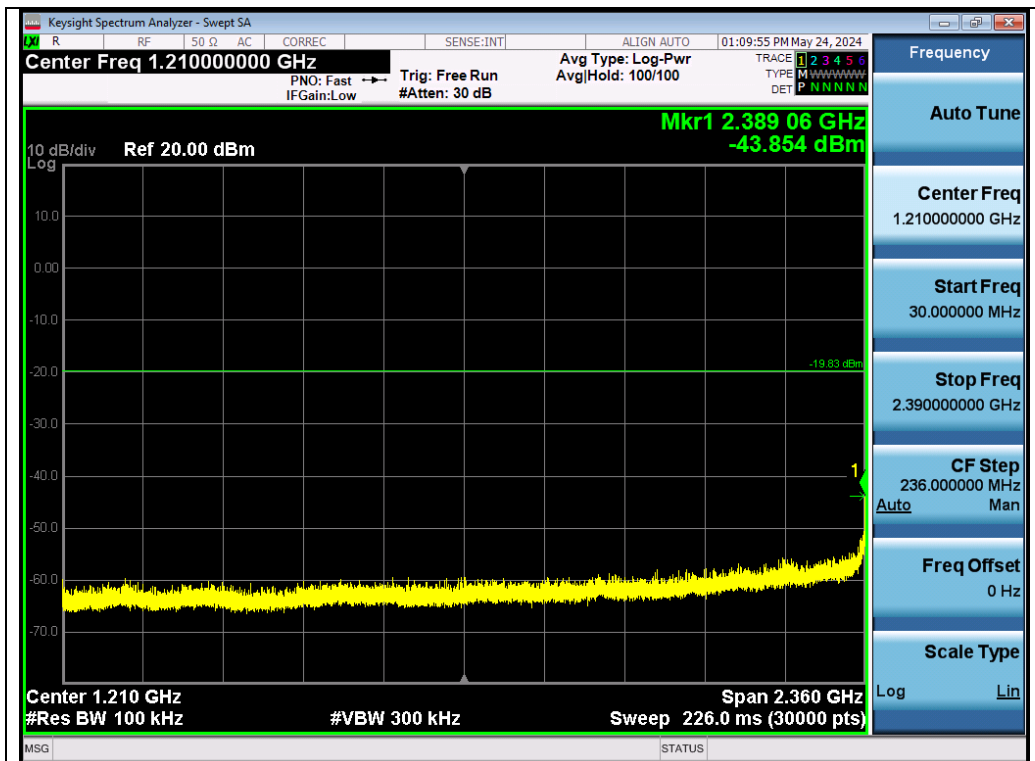

Test_Graph_802.11n20_ANT1_2412_MCS0_Lower Band Emissions

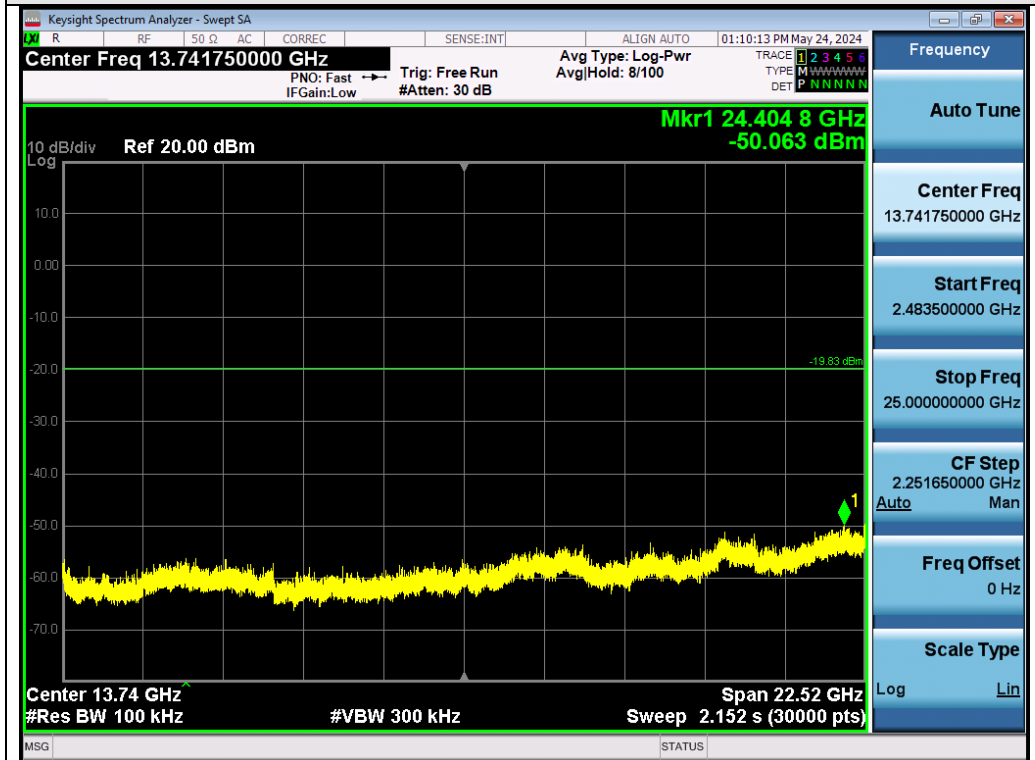

Test_Graph_802.11n20_ANT1_2412_MCS0_Higher Band Emissions

Any report having not been signed by authorized approver, or having been altered without authorization, or having not been stamped by the "Dedicated Testing/Inspection Stamp" is deemed to be invalid. Copying or excerpting portion of, or altering the content of the report is not permitted without the written authorization of AGC. The test results presented in the report apply only to the tested sample. Any objections to report issued by AGC should be submitted to AGC within 15days after the issuance of the test report. Further enquiry of validity or verification of the test report should be addressed to AGC by agc01@agccert.com.

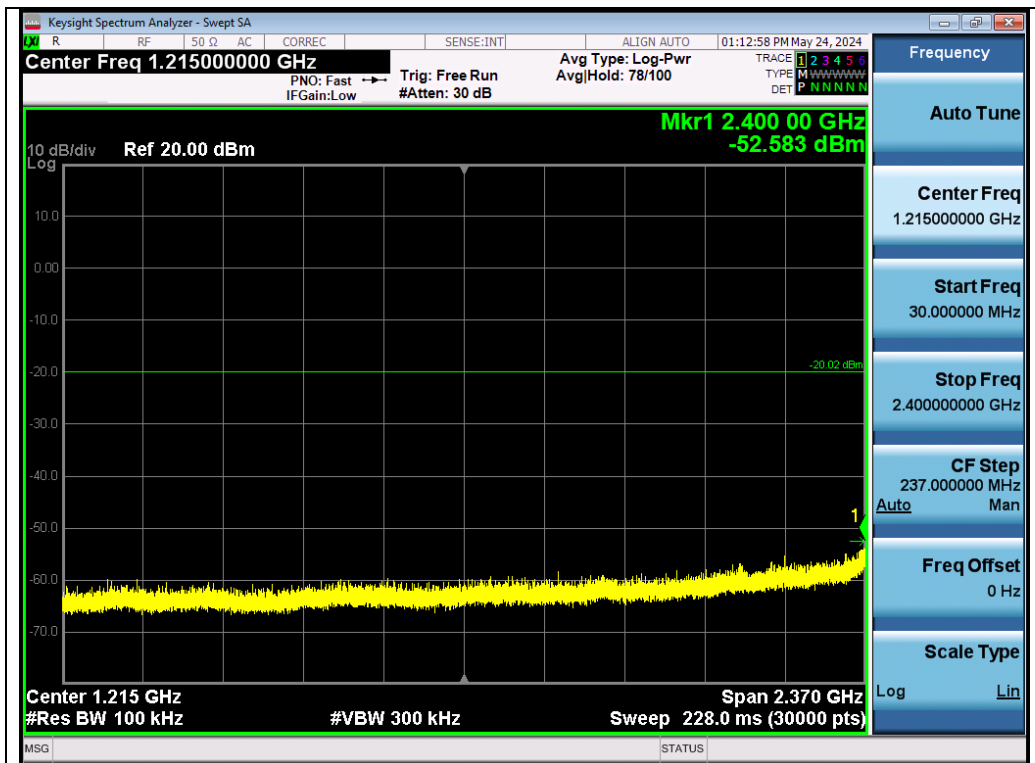

Test_Graph_802.11n20_ANT1_2437_MCS0_Lower Band Emissions

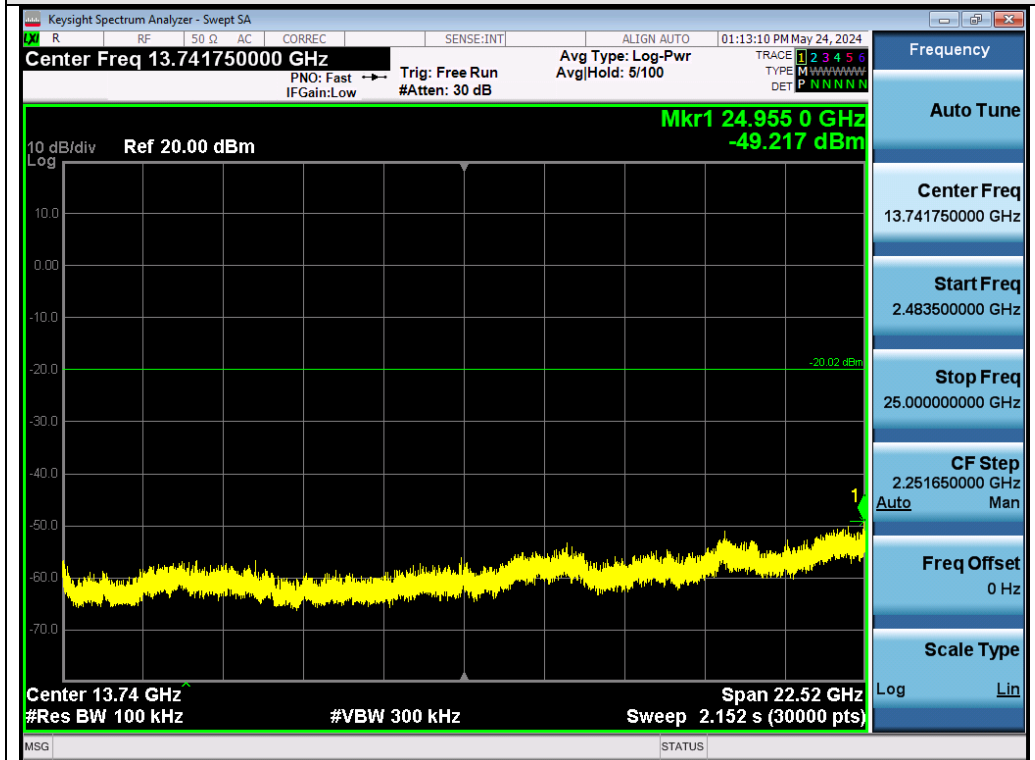

Test_Graph_802.11n20_ANT1_2437_MCS0_Higher Band Emissions

Any report having not been signed by authorized approver, or having been altered without authorization, or having not been stamped by the "Dedicated Testing/Inspection Stamp" is deemed to be invalid. Copying or excerpting portion of, or altering the content of the report is not permitted without the written authorization of AGC. The test results presented in the report apply only to the tested sample. Any objections to report issued by AGC should be submitted to AGC within 15days after the issuance of the test report. Further enquiry of validity or verification of the test report should be addressed to AGC by agc01@agccert.com.

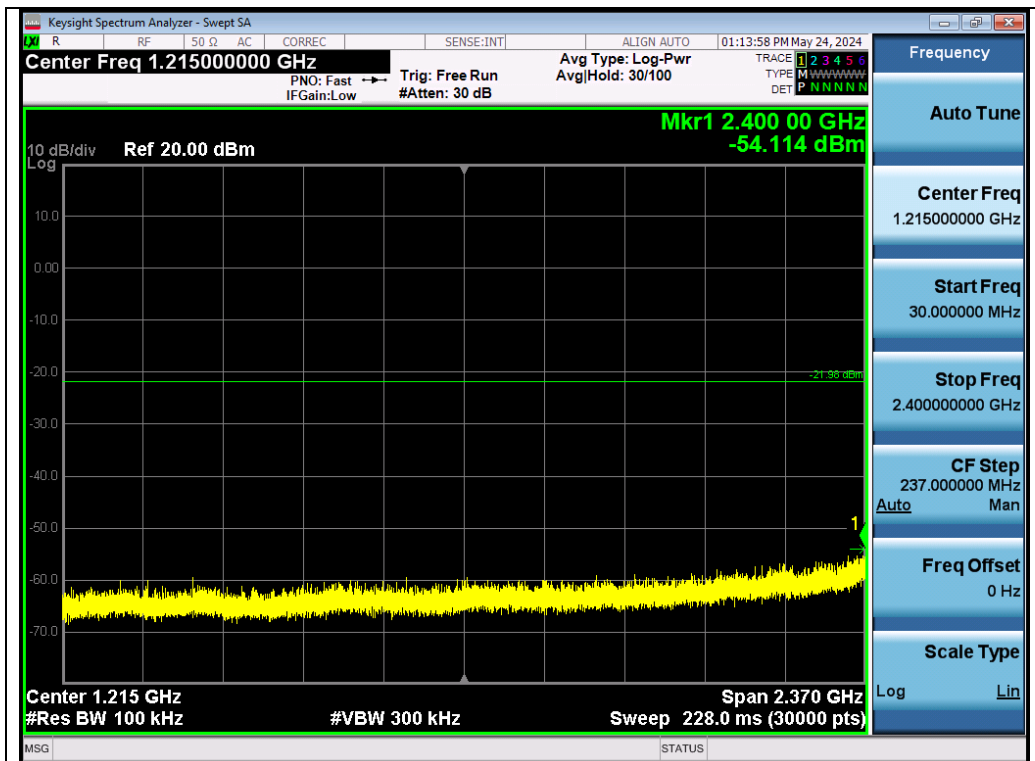

Test_Graph_802.11n20_ANT1_2462_MCS0_Lower Band Emissions

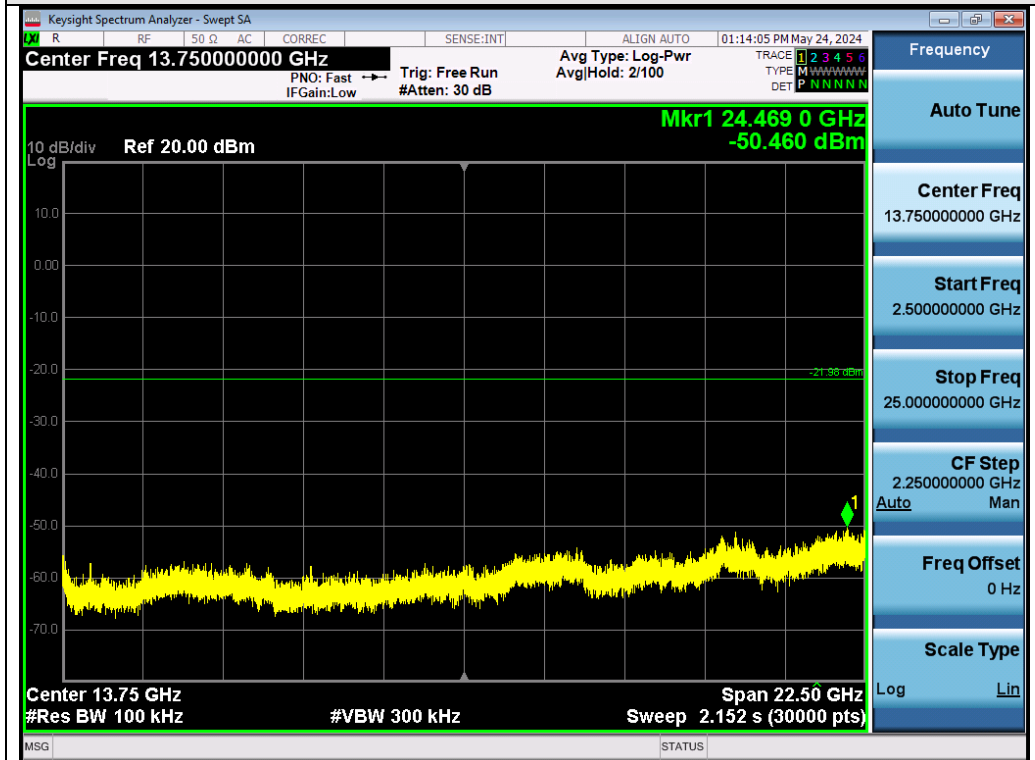

Test_Graph_802.11n20_ANT1_2462_MCS0_Higher Band Emissions

Any report having not been signed by authorized approver, or having been altered without authorization, or having not been stamped by the "Dedicated Testing/Inspection Stamp" is deemed to be invalid. Copying or excerpting portion of, or altering the content of the report is not permitted without the written authorization of AGC. The test results presented in the report apply only to the tested sample. Any objections to report issued by AGC should be submitted to AGC within 15days after the issuance of the test report. Further enquiry of validity or verification of the test report should be addressed to AGC by agc01@agccert.com.

Test Graphs of Band Edge Emissions in Non-Restricted Frequency Bands

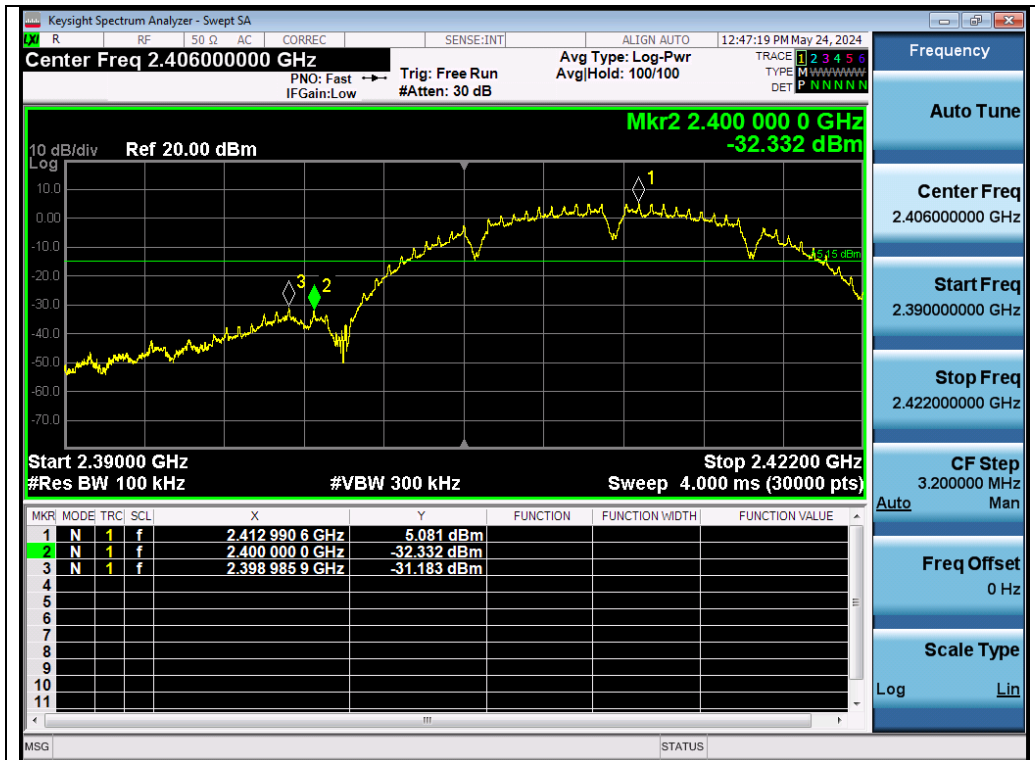

Test_Graph_802.11b_ANT1_2412_1Mbps_Lower Band Edge Emissions

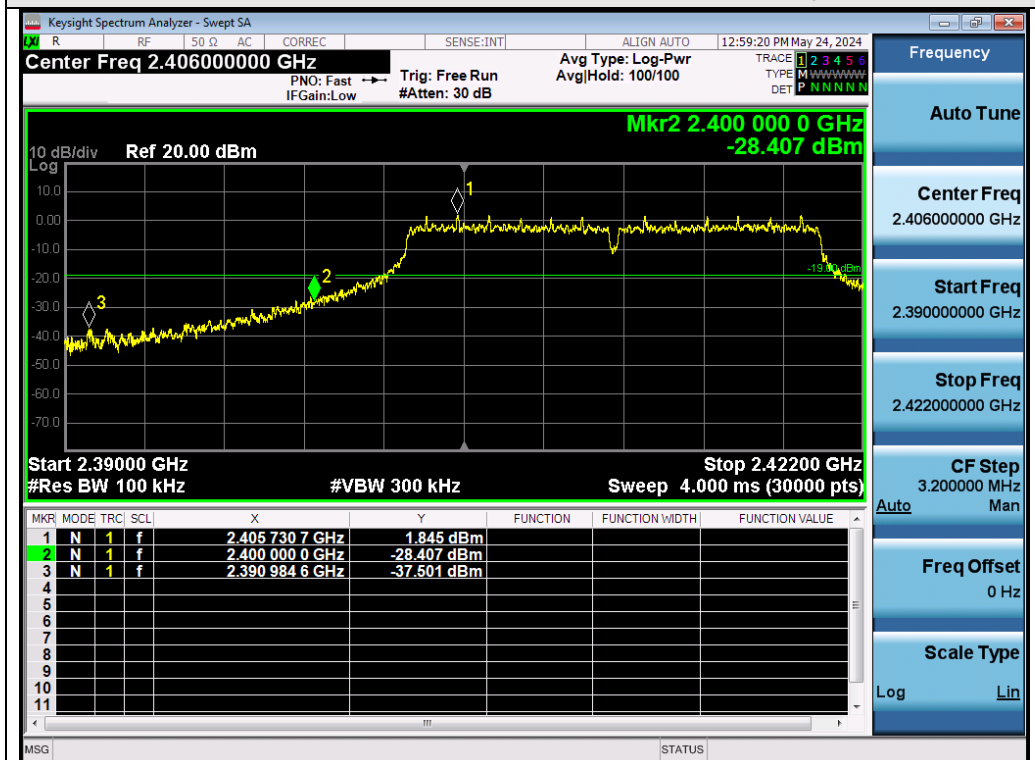

Test_Graph_802.11g_ANT1_2412_6Mbps_Lower Band Edge Emissions

Any report having not been signed by authorized approver, or having been altered without authorization, or having not been stamped by the "Dedicated Testing/Inspection Stamp" is deemed to be invalid. Copying or excerpting portion of, or altering the content of the report is not permitted without the written authorization of AGC. The test results presented in the report apply only to the tested sample. Any objections to report issued by AGC should be submitted to AGC within 15days after the issuance of the test report. Further enquiry of validity or verification of the test report should be addressed to AGC by agc01@agccert.com.

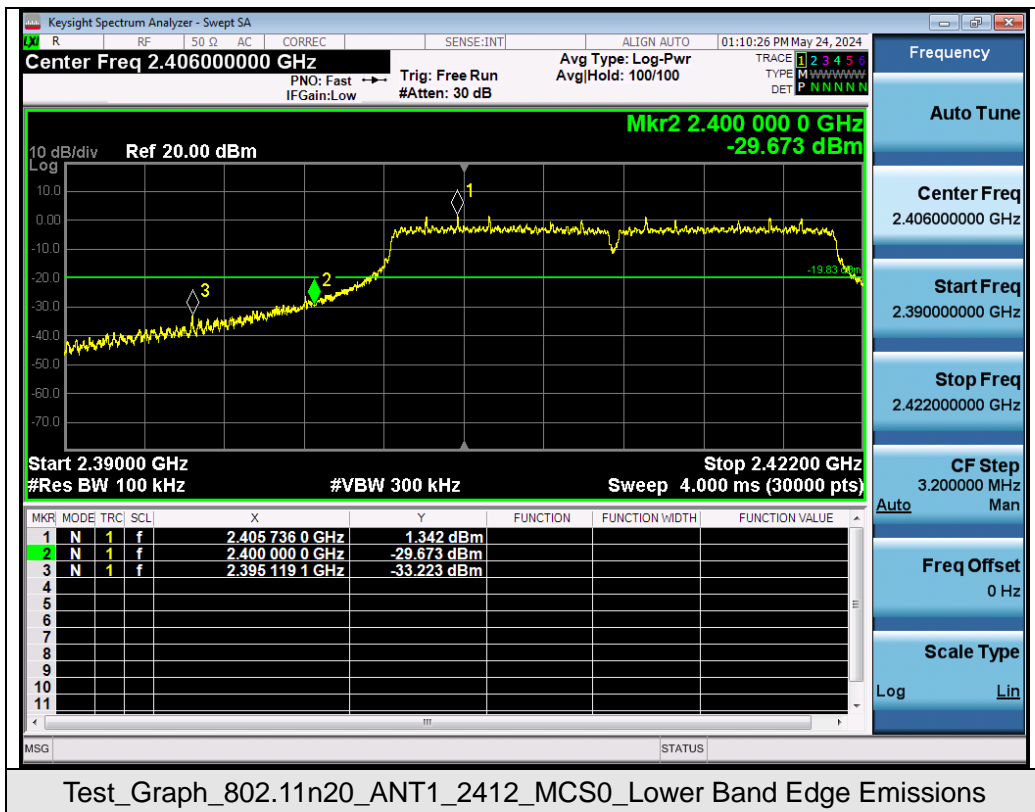

Note: Emissions from 2483.5-2500MHz which fall in the restricted bands had been considered with the radiated emission limits specified.

Any report having not been signed by authorized approver, or having been altered without authorization, or having not been stamped by the "Dedicated Testing/Inspection Stamp" is deemed to be invalid. Copying or excerpting portion of, or altering the content of the report is not permitted without the written authorization of AGC. The test results presented in the report apply only to the tested sample. Any objections to report issued by AGC should be submitted to AGC within 15days after the issuance of the test report. Further enquiry of validity or verification of the test report should be addressed to AGC by agc01@agccert.com.

11. Radiated Spurious Emission

11.1 Measurement Limits

15.209(a) Limit in the below table has to be followed

| Frequencies (MHz) | Field Strength (microvolts/meter) | Measurement Distance (meters) |
|-------------------|-----------------------------------|-------------------------------|
| 0.009~0.490 | 2400/F(kHz) | 300 |
| 0.490~1.705 | 24000/F(kHz) | 30 |
| 1.705~30.0 | 30 | 30 |
| 30~88 | 100 | 3 |
| 88~216 | 150 | 3 |
| 216~960 | 200 | 3 |
| Above 960 | 500 | 3 |

Note: All modes were tested for restricted band radiated emission, the test records reported below are the worst result compared to other modes.

11.2 Measurement Procedure

1. The EUT was placed on the top of the turntable 0.8 or 1.5 meter above ground. The phase center of the receiving antenna mounted on the top of a height-variable antenna tower was placed 3 meters far away from the turntable.
2. Power on the EUT and all the supporting units. The turntable was rotated by 360 degrees to determine the position of the highest radiation.
3. The height of the broadband receiving antenna was varied between one meter and four meters above ground to find the maximum emissions field strength of both horizontal and vertical polarization.
4. For each suspected emission, the antenna tower was scan (from 1 M to 4 M) and then the turntable was rotated (from 0 degree to 360 degrees) to find the maximum reading.
5. Set the test-receiver system to Peak or CISPR quasi-peak Detect Function with specified bandwidth under Maximum Hold Mode.
6. For emissions above 1GHz, use 1MHz RBW and 3MHz VBW for peak reading. Place the measurement antenna away from each area of the EUT determined to be a source of emissions at the specified measurement distance, while keeping the measurement antenna aimed at the source of emissions at each frequency of significant emissions, with polarization oriented for maximum response. The measurement antenna may have to be higher or lower than the EUT, depending on the radiation pattern of the emission and staying aimed at the emission source for receiving the maximum signal. The final measurement antenna elevation shall be that which maximizes the emissions. The measurement antenna elevation for maximum emissions shall be restricted to a range of heights of from 1 m to 4 m above the ground or reference ground plane.
7. When the radiated emissions limits are expressed in terms of the average value of the emissions, and pulsed operation is employed, the measurement field strength shall be determined by averaging over one complete pulse train, including blanking intervals, as long as the pulse train does not exceed 0.1 seconds.

Any report having not been signed by authorized approver, or having been altered without authorization, or having not been stamped by the "Dedicated Testing/Inspection Stamp" is deemed to be invalid. Copying or excerpting portion of, or altering the content of the report is not permitted without the written authorization of AGC. The test results presented in the report apply only to the tested sample. Any objections to report issued by AGC should be submitted to AGC within 15days after the issuance of the test report. Further enquiry of validity or verification of the test report should be addressed to AGC by agc01@agccert.com.

As an alternative (provided the transmitter operates for longer than 0.1 seconds) or in cases where the pulse train exceeds 0.1 seconds, the measured field strength shall be determined from the average absolute voltage during a 0.1 second interval during which the field strength is at its maximum values.

8. If the emissions level of the EUT in peak mode was 3 dB lower than the average limit specified, then testing will be stopped and peak values of EUT will be reported, otherwise, the emissions which do not have 3 dB margin will be repeated one by one using the quasi-peak method for below 1GHz.
9. For testing above 1GHz, the emissions level of the EUT in peak mode was lower than average limit (that means the emissions level in peak mode also complies with the limit in average mode), then testing will be stopped and peak values of EUT will be reported, otherwise, the emissions will be measured in average mode again and reported.
10. In case the emission is lower than 30MHz, loop antenna has to be used for measurement and the recorded data should be QP measured by receiver. High - Low scan is not required in this case.

◆ The following table is the setting of spectrum analyzer and receiver.

| Spectrum Parameter | Setting |
|-----------------------|---|
| Start ~Stop Frequency | 9KHz~150KHz/RB 200Hz for QP |
| Start ~Stop Frequency | 150KHz~30MHz/RB 9KHz for QP |
| Start ~Stop Frequency | 30MHz~1000MHz/RB 120KHz for QP |
| Start ~Stop Frequency | 1GHz~26.5GHz 1MHz/3MHz for Peak, 1MHz/3MHz for Average |

| Receiver Parameter | Setting |
|-----------------------|--------------------------------|
| Start ~Stop Frequency | 9KHz~150KHz/RB 200Hz for QP |
| Start ~Stop Frequency | 150KHz~30MHz/RB 9KHz for QP |
| Start ~Stop Frequency | 30MHz~1000MHz/RB 120KHz for QP |

Any report having not been signed by authorized approver, or having been altered without authorization, or having not been stamped by the "Dedicated Testing/Inspection Stamp" is deemed to be invalid. Copying or excerpting portion of, or altering the content of the report is not permitted without the written authorization of AGC. The test results presented in the report apply only to the tested sample. Any objections to report issued by AGC should be submitted to AGC within 15days after the issuance of the test report. Further enquiry of validity or verification of the test report should be addressed to AGC by agc01@agccert.com.

- **Quasi-Peak Measurements below 1GHz**

1. Analyzer center frequency was set to the frequency of the radiated spurious emission of interest
2. Span was set greater than 1MHz
3. RBW = as shown in the table above
4. Detector = CISPR quasi-peak
5. Sweep time = auto couple
6. Trace was allowed to stabilize

- **Peak Measurements above 1GHz**

1. Analyzer center frequency was set to the frequency of the radiated spurious emission of interest
2. RBW = 1MHz
3. VBW = 3MHz
4. Detector = peak
5. Sweep time = auto couple
6. Trace mode = max hold
7. Trace was allowed to stabilize

- **Average Measurements above 1GHz (Method VB)**

1. Analyzer center frequency was set to the frequency of the radiated spurious emission of interest
2. RBW = 1MHz
3. VBW setting requirements are as follows:
4. If the EUT is configured to transmit with duty cycle $\geq 98\%$, set VBW = 10 Hz.
5. If the EUT duty cycle is $< 98\%$, set VBW $\geq 1/T$. T is the minimum transmission duration.
6. Detector = Peak
7. Sweep time = auto
8. Trace mode = max hold

Any report having not been signed by authorized approver, or having been altered without authorization, or having not been stamped by the "Dedicated Testing/Inspection Stamp" is deemed to be invalid. Copying or excerpting portion of, or altering the content of the report is not permitted without the written authorization of AGC. The test results presented in the report apply only to the tested sample. Any objections to report issued by AGC should be submitted to AGC within 15days after the issuance of the test report. Further enquiry of validity or verification of the test report should be addressed to AGC by agc01@agccert.com.

11.3 Measurement Setup (Block Diagram of Configuration)

Radiated Emission Test Setup 9kHz-30MHz

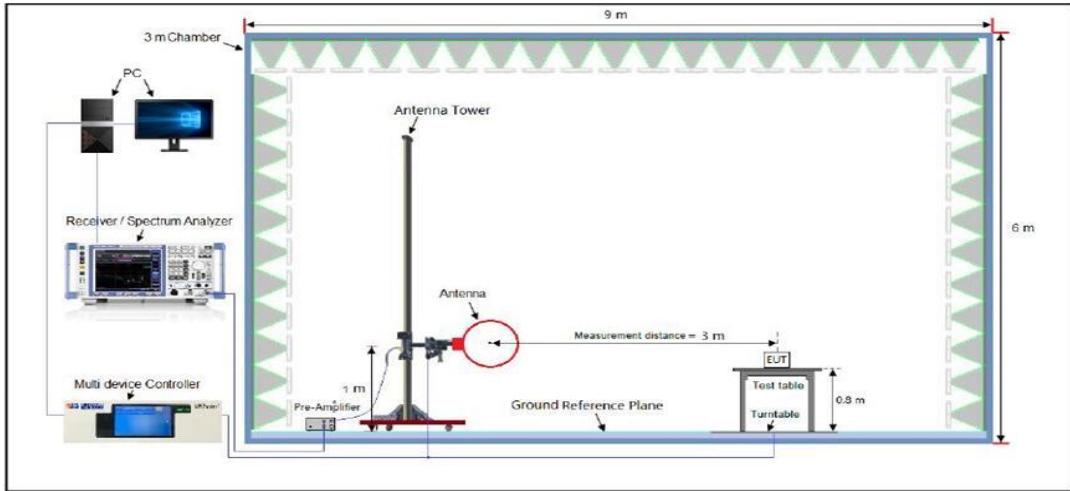

Radiated Emission Test Setup 30MHz-1000MHz

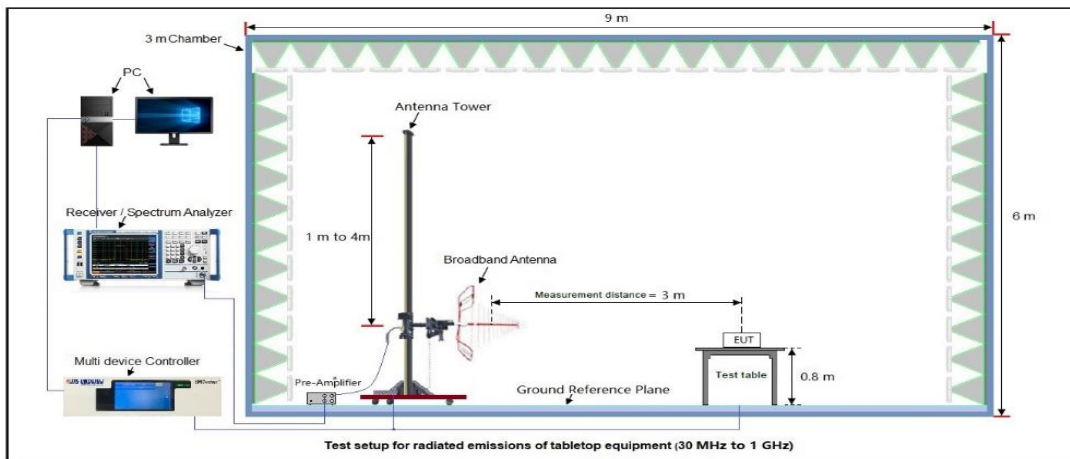

Radiated Emission Test Setup Above 1000MHz

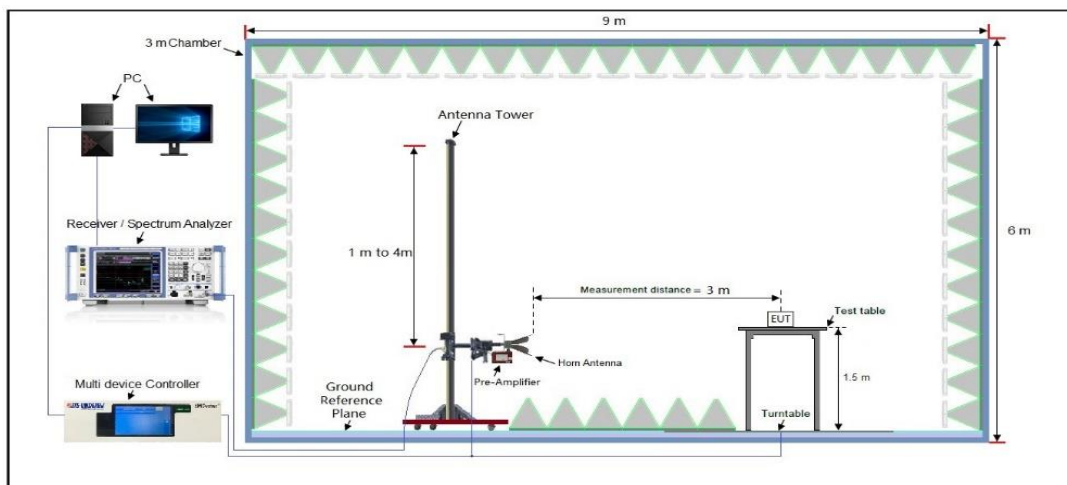

Any report having not been signed by authorized approver, or having been altered without authorization, or having not been stamped by the "Dedicated Testing/Inspection Stamp" is deemed to be invalid. Copying or excerpting portion of, or altering the content of the report is not permitted without the written authorization of AGC. The test results presented in the report apply only to the tested sample. Any objections to report issued by AGC should be submitted to AGC within 15days after the issuance of the test report. Further enquiry of validity or verification of the test report should be addressed to AGC by agc01@agccert.com.

11.4 Measurement Result

Radiated Emission at 9kHz-30MHz

The amplitude of spurious emissions from 9kHz to 30MHz which are attenuated more than 20 dB below the permissible value need not be reported.

| Radiated Emission Test Results at 30MHz-1GHz | | | |
|--|--|--------------------------|------------|
| EUT Name | Baseus Security P1 Lite Indoor Camera 2K | Model Name | S0TV00 |
| Temperature | 22.3°C | Relative Humidity | 59.9% |
| Pressure | 960hPa | Test Voltage | DC 5V |
| Test Mode | Mode 4 | Antenna Polarity | Horizontal |

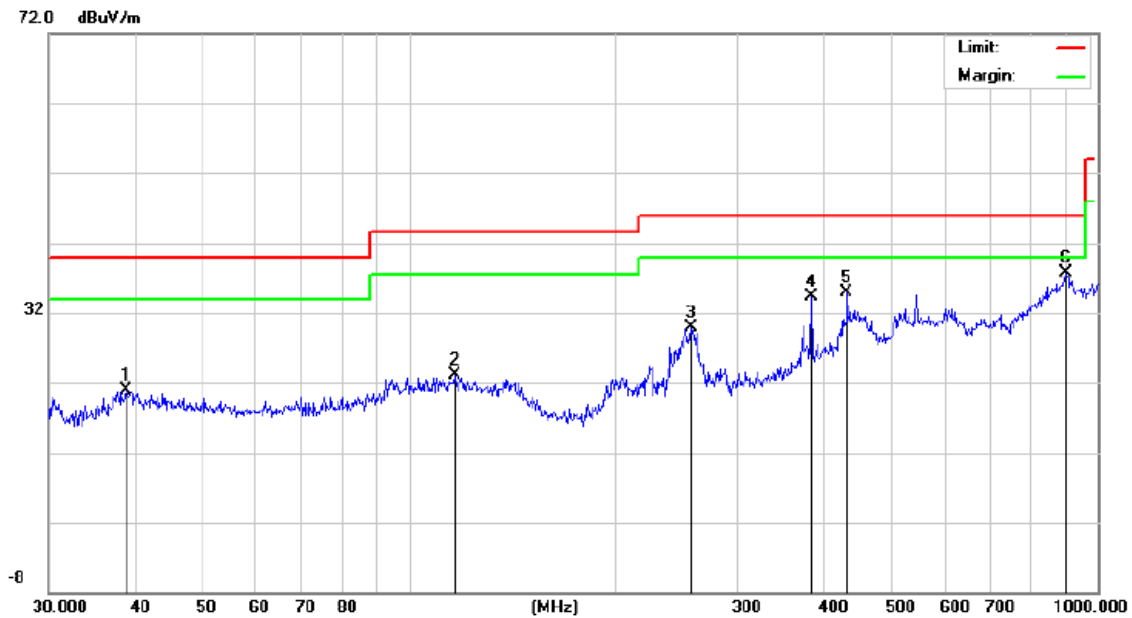

| No. | Mk. | Freq. | Reading Level | Correct Factor | Measurement | Limit | Over | Detector |
|-----|-----|----------|---------------|----------------|-------------|--------|--------|----------|
| | | MHz | dBuV | dB | dBuV/m | dBuV/m | dB | |
| 1 | | 38.8878 | 7.45 | 13.42 | 20.87 | 40.00 | -19.13 | peak |
| 2 | | 116.5401 | 6.71 | 16.37 | 23.08 | 43.50 | -20.42 | peak |
| 3 | | 256.5211 | 15.02 | 14.90 | 29.92 | 46.00 | -16.08 | peak |
| 4 | | 383.9318 | 15.72 | 18.63 | 34.35 | 46.00 | -11.65 | peak |
| 5 | | 432.5457 | 11.33 | 23.50 | 34.83 | 46.00 | -11.17 | peak |
| 6 | * | 900.1474 | 5.96 | 31.78 | 37.74 | 46.00 | -8.26 | peak |

Any report having not been signed by authorized approver, or having been altered without authorization, or having not been stamped by the "Dedicated Testing/Inspection Stamp" is deemed to be invalid. Copying or excerpting portion of, or altering the content of the report is not permitted without the written authorization of AGC. The test results presented in the report apply only to the tested sample. Any objections to report issued by AGC should be submitted to AGC within 15days after the issuance of the test report. Further enquiry of validity or verification of the test report should be addressed to AGC by agc01@agccert.com.

| Radiated Emission Test Results at 30MHz-1GHz | | | |
|--|--|--------------------------|----------|
| EUT Name | Baseus Security P1 Lite Indoor Camera 2K | Model Name | S0TV00 |
| Temperature | 22.3°C | Relative Humidity | 59.9% |
| Pressure | 960hPa | Test Voltage | DC 5V |
| Test Mode | Mode 4 | Antenna Polarity | Vertical |

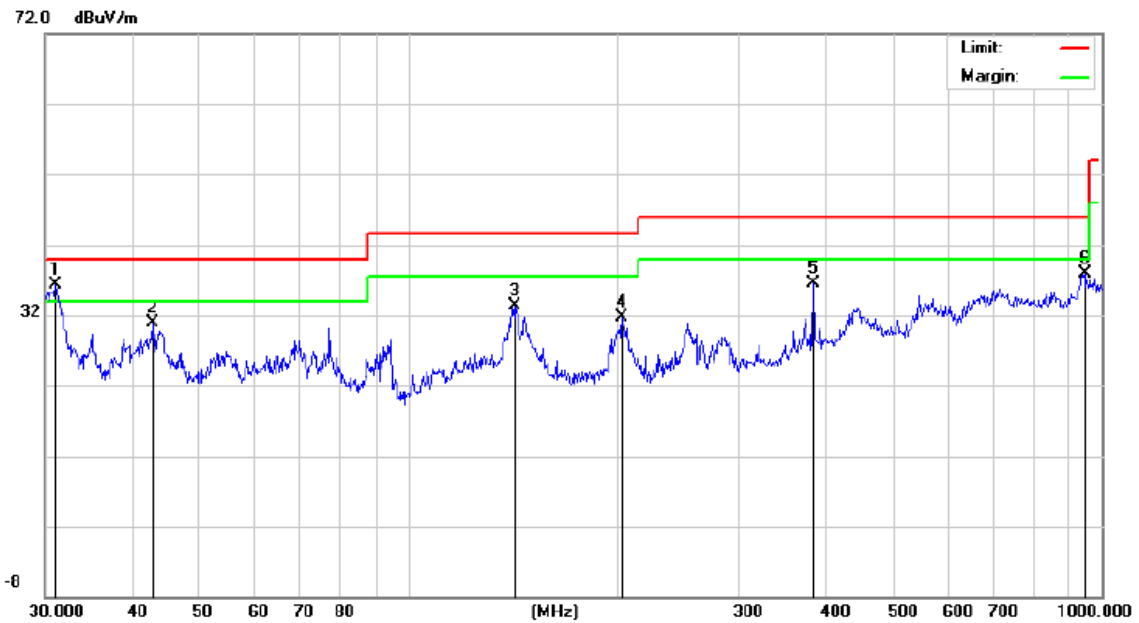

| No. | Mk. | Freq. MHz | Reading Level dBuV | Correct Factor dB | Measure- ment dBuV/m | Limit dBuV/m | Over dB | Detector |
|-----|-----|--------------|--------------------------|-------------------------|----------------------------|-----------------|------------|----------|
| 1 | * | 31.0706 | 22.31 | 13.95 | 36.26 | 40.00 | -3.74 | peak |
| 2 | | 42.8998 | 13.96 | 16.93 | 30.89 | 40.00 | -9.11 | peak |
| 3 | | 142.8243 | 15.10 | 18.20 | 33.30 | 43.50 | -10.20 | peak |
| 4 | | 203.5228 | 14.06 | 17.64 | 31.70 | 43.50 | -11.80 | peak |
| 5 | | 383.9318 | 14.90 | 21.56 | 36.46 | 46.00 | -9.54 | peak |
| 6 | | 945.4399 | 7.13 | 30.78 | 37.91 | 46.00 | -8.09 | peak |

RESULT: Pass

Note: 1. Factor=Antenna Factor + Cable loss, Over=Measurement-Limit.

2. All test modes had been pre-tested. The mode 4 is the worst case and recorded in the report.

Any report having not been signed by authorized approver, or having been altered without authorization, or having not been stamped by the "Dedicated Testing/Inspection Stamp" is deemed to be invalid. Copying or excerpting portion of, or altering the content of the report is not permitted without the written authorization of AGC. The test results presented in the report apply only to the tested sample. Any objections to report issued by AGC should be submitted to AGC within 15days after the issuance of the test report. Further enquiry of validity or verification of the test report should be addressed to AGC by agc01@agccert.com.

Radiated Emissions Test Results above 1 GHz

| | | | |
|--------------------|--|--------------------------|------------|
| EUT Name | Baseus Security P1 Lite Indoor Camera 2K | Model Name | S0TV00 |
| Temperature | 22.3°C | Relative Humidity | 59.9% |
| Pressure | 960hPa | Test Voltage | DC 5V |
| Test Mode | Mode 1 | Antenna Polarity | Horizontal |

| Frequency (MHz) | Meter Reading (dBµV) | Factor (dB) | Emission Level (dBµV/m) | Limits (dBµV/m) | Margin (dB) | Value Type |
|-----------------|----------------------|-------------|-------------------------|-----------------|-------------|------------|
| 4824.000 | 47.39 | 0.08 | 47.47 | 74 | -26.53 | peak |
| 4824.000 | 38.22 | 0.08 | 38.3 | 54 | -15.7 | AVG |
| 7236.000 | 41.37 | 2.21 | 43.58 | 74 | -30.42 | peak |
| 7236.000 | 32.52 | 2.21 | 34.73 | 54 | -19.27 | AVG |
| | | | | | | |
| | | | | | | |

Remark:
Factor = Antenna Factor + Cable Loss – Pre-amplifier.

| | | | |
|--------------------|--|--------------------------|----------|
| EUT Name | Baseus Security P1 Lite Indoor Camera 2K | Model Name | S0TV00 |
| Temperature | 22.3°C | Relative Humidity | 59.9% |
| Pressure | 960hPa | Test Voltage | DC 5V |
| Test Mode | Mode 1 | Antenna Polarity | Vertical |

| Frequency (MHz) | Meter Reading (dBµV) | Factor (dB) | Emission Level (dBµV/m) | Limits (dBµV/m) | Margin (dB) | Value Type |
|-----------------|----------------------|-------------|-------------------------|-----------------|-------------|------------|
| 4824.000 | 47.62 | 0.08 | 47.7 | 74 | -26.3 | peak |
| 4824.000 | 37.46 | 0.08 | 37.54 | 54 | -16.46 | AVG |
| 7236.000 | 41.31 | 2.21 | 43.52 | 74 | -30.48 | peak |
| 7236.000 | 32.25 | 2.21 | 34.46 | 54 | -19.54 | AVG |
| | | | | | | |
| | | | | | | |

Remark:
Factor = Antenna Factor + Cable Loss – Pre-amplifier.

RESULT: Pass

Any report having not been signed by authorized approver, or having been altered without authorization, or having not been stamped by the “Dedicated Testing/Inspection Stamp” is deemed to be invalid. Copying or excerpting portion of, or altering the content of the report is not permitted without the written authorization of AGC. The test results presented in the report apply only to the tested sample. Any objections to report issued by AGC should be submitted to AGC within 15days after the issuance of the test report. Further enquiry of validity or verification of the test report should be addressed to AGC by agc01@agccert.com.

Radiated Emissions Test Results above 1GHz

| | | | |
|--------------------|--|--------------------------|------------|
| EUT Name | Baseus Security P1 Lite Indoor Camera 2K | Model Name | S0TV00 |
| Temperature | 22.3°C | Relative Humidity | 59.9% |
| Pressure | 960hPa | Test Voltage | DC 5V |
| Test Mode | Mode 2 | Antenna Polarity | Horizontal |

| Frequency (MHz) | Meter Reading (dBµV) | Factor (dB) | Emission Level (dBµV/m) | Limits (dBµV/m) | Margin (dB) | Value Type |
|-----------------|----------------------|-------------|-------------------------|-----------------|-------------|------------|
| 4874.000 | 48.76 | 0.14 | 48.9 | 74 | -25.1 | peak |
| 4874.000 | 38.51 | 0.14 | 38.65 | 54 | -15.35 | AVG |
| 7311.000 | 42.39 | 2.36 | 44.75 | 74 | -29.25 | peak |
| 7311.000 | 32.64 | 2.36 | 35 | 54 | -19 | AVG |
| | | | | | | |
| | | | | | | |

Remark:

Factor = Antenna Factor + Cable Loss – Pre-amplifier.

| | | | |
|--------------------|--|--------------------------|----------|
| EUT Name | Baseus Security P1 Lite Indoor Camera 2K | Model Name | S0TV00 |
| Temperature | 22.3°C | Relative Humidity | 59.9% |
| Pressure | 960hPa | Test Voltage | DC 5V |
| Test Mode | Mode 2 | Antenna Polarity | Vertical |

| Frequency (MHz) | Meter Reading (dBµV) | Factor (dB) | Emission Level (dBµV/m) | Limits (dBµV/m) | Margin (dB) | Value Type |
|-----------------|----------------------|-------------|-------------------------|-----------------|-------------|------------|
| 4874.000 | 47.81 | 0.14 | 47.95 | 74 | -26.05 | peak |
| 4874.000 | 38.36 | 0.14 | 38.5 | 54 | -15.5 | AVG |
| 7311.000 | 42.72 | 2.36 | 45.08 | 74 | -28.92 | peak |
| 7311.000 | 31.51 | 2.36 | 33.87 | 54 | -20.13 | AVG |
| | | | | | | |
| | | | | | | |

Remark:

Factor = Antenna Factor + Cable Loss – Pre-amplifier.

RESULT: Pass

Any report having not been signed by authorized approver, or having been altered without authorization, or having not been stamped by the “Dedicated Testing/Inspection Stamp” is deemed to be invalid. Copying or excerpting portion of, or altering the content of the report is not permitted without the written authorization of AGC. The test results presented in the report apply only to the tested sample. Any objections to report issued by AGC should be submitted to AGC within 15days after the issuance of the test report. Further enquiry of validity or verification of the test report should be addressed to AGC by agc01@agccert.com.

Radiated Emissions Test Results above 1GHz

| | | | |
|--------------------|--|--------------------------|------------|
| EUT Name | Baseus Security P1 Lite Indoor Camera 2K | Model Name | S0TV00 |
| Temperature | 22.3°C | Relative Humidity | 59.9% |
| Pressure | 960hPa | Test Voltage | DC 5V |
| Test Mode | Mode 3 | Antenna Polarity | Horizontal |

| Frequency (MHz) | Meter Reading (dBµV) | Factor (dB) | Emission Level (dBµV/m) | Limits (dBµV/m) | Margin (dB) | Value Type |
|-----------------|----------------------|-------------|-------------------------|-----------------|-------------|------------|
| 4924.000 | 49.28 | 0.22 | 49.5 | 74 | -24.5 | peak |
| 4924.000 | 38.53 | 0.22 | 38.75 | 54 | -15.25 | AVG |
| 7386.000 | 41.34 | 2.64 | 43.98 | 74 | -30.02 | peak |
| 7386.000 | 32.41 | 2.64 | 35.05 | 54 | -18.95 | AVG |
| | | | | | | |
| | | | | | | |

Remark:

Factor = Antenna Factor + Cable Loss – Pre-amplifier.

| | | | |
|--------------------|--|--------------------------|----------|
| EUT Name | Baseus Security P1 Lite Indoor Camera 2K | Model Name | S0TV00 |
| Temperature | 22.3°C | Relative Humidity | 59.9% |
| Pressure | 960hPa | Test Voltage | DC 5V |
| Test Mode | Mode 3 | Antenna Polarity | Vertical |

| Frequency (MHz) | Meter Reading (dBµV) | Factor (dB) | Emission Level (dBµV/m) | Limits (dBµV/m) | Margin (dB) | Value Type |
|-----------------|----------------------|-------------|-------------------------|-----------------|-------------|------------|
| 4924.000 | 47.61 | 0.22 | 47.83 | 74 | -26.17 | peak |
| 4924.000 | 38.52 | 0.22 | 38.74 | 54 | -15.26 | AVG |
| 7386.000 | 41.63 | 2.64 | 44.27 | 74 | -29.73 | peak |
| 7386.000 | 32.71 | 2.64 | 35.35 | 54 | -18.65 | AVG |
| | | | | | | |
| | | | | | | |

Remark:

Factor = Antenna Factor + Cable Loss – Pre-amplifier.

RESULT: Pass

Any report having not been signed by authorized approver, or having been altered without authorization, or having not been stamped by the “Dedicated Testing/Inspection Stamp” is deemed to be invalid. Copying or excerpting portion of, or altering the content of the report is not permitted without the written authorization of AGC. The test results presented in the report apply only to the tested sample. Any objections to report issued by AGC should be submitted to AGC within 15days after the issuance of the test report. Further enquiry of validity or verification of the test report should be addressed to AGC by agc01@agccert.com.

Radiated Emissions Test Results above 1GHz

| | | | |
|--------------------|--|--------------------------|------------|
| EUT Name | Baseus Security P1 Lite Indoor Camera 2K | Model Name | S0TV00 |
| Temperature | 22.3°C | Relative Humidity | 59.9% |
| Pressure | 960hPa | Test Voltage | DC 5V |
| Test Mode | Mode 4 | Antenna Polarity | Horizontal |

| Frequency (MHz) | Meter Reading (dBµV) | Factor (dB) | Emission Level (dBµV/m) | Limits (dBµV/m) | Margin (dB) | Value Type |
|-----------------|----------------------|-------------|-------------------------|-----------------|-------------|------------|
| 4824.000 | 46.52 | 0.08 | 46.6 | 74 | -27.4 | peak |
| 4824.000 | 37.71 | 0.08 | 37.79 | 54 | -16.21 | AVG |
| 7236.000 | 41.62 | 2.21 | 43.83 | 74 | -30.17 | peak |
| 7236.000 | 32.55 | 2.21 | 34.76 | 54 | -19.24 | AVG |
| | | | | | | |
| | | | | | | |

Remark:
Factor = Antenna Factor + Cable Loss – Pre-amplifier.

| | | | |
|--------------------|--|--------------------------|----------|
| EUT Name | Baseus Security P1 Lite Indoor Camera 2K | Model Name | S0TV00 |
| Temperature | 22.3°C | Relative Humidity | 59.9% |
| Pressure | 960hPa | Test Voltage | DC 5V |
| Test Mode | Mode 4 | Antenna Polarity | Vertical |

| Frequency (MHz) | Meter Reading (dBµV) | Factor (dB) | Emission Level (dBµV/m) | Limits (dBµV/m) | Margin (dB) | Value Type |
|-----------------|----------------------|-------------|-------------------------|-----------------|-------------|------------|
| 4824.000 | 46.56 | 0.08 | 46.64 | 74 | -27.36 | peak |
| 4824.000 | 37.81 | 0.08 | 37.89 | 54 | -16.11 | AVG |
| 7236.000 | 41.63 | 2.21 | 43.84 | 74 | -30.16 | peak |
| 7236.000 | 32.59 | 2.21 | 34.8 | 54 | -19.2 | AVG |
| | | | | | | |
| | | | | | | |

Remark:
Factor = Antenna Factor + Cable Loss – Pre-amplifier.

RESULT: Pass

Any report having not been signed by authorized approver, or having been altered without authorization, or having not been stamped by the “Dedicated Testing/Inspection Stamp” is deemed to be invalid. Copying or excerpting portion of, or altering the content of the report is not permitted without the written authorization of AGC. The test results presented in the report apply only to the tested sample. Any objections to report issued by AGC should be submitted to AGC within 15days after the issuance of the test report. Further enquiry of validity or verification of the test report should be addressed to AGC by agc01@agccert.com.

Radiated Emissions Test Results above 1GHz

| | | | |
|--------------------|--|--------------------------|------------|
| EUT Name | Baseus Security P1 Lite Indoor Camera 2K | Model Name | S0TV00 |
| Temperature | 22.3°C | Relative Humidity | 59.9% |
| Pressure | 960hPa | Test Voltage | DC 5V |
| Test Mode | Mode 5 | Antenna Polarity | Horizontal |

| Frequency (MHz) | Meter Reading (dBµV) | Factor (dB) | Emission Level (dBµV/m) | Limits (dBµV/m) | Margin (dB) | Value Type |
|-----------------|----------------------|-------------|-------------------------|-----------------|-------------|------------|
| 4874.000 | 45.96 | 0.14 | 46.1 | 74 | -27.9 | peak |
| 4874.000 | 38.43 | 0.14 | 38.57 | 54 | -15.43 | AVG |
| 7311.000 | 41.57 | 2.36 | 43.93 | 74 | -30.07 | peak |
| 7311.000 | 34.39 | 2.36 | 36.75 | 54 | -17.25 | AVG |
| | | | | | | |
| | | | | | | |

Remark:
Factor = Antenna Factor + Cable Loss – Pre-amplifier.

| | | | |
|--------------------|--|--------------------------|----------|
| EUT Name | Baseus Security P1 Lite Indoor Camera 2K | Model Name | S0TV00 |
| Temperature | 22.3°C | Relative Humidity | 59.9% |
| Pressure | 960hPa | Test Voltage | DC 5V |
| Test Mode | Mode 5 | Antenna Polarity | Vertical |

| Frequency (MHz) | Meter Reading (dBµV) | Factor (dB) | Emission Level (dBµV/m) | Limits (dBµV/m) | Margin (dB) | Value Type |
|-----------------|----------------------|-------------|-------------------------|-----------------|-------------|------------|
| 4874.000 | 45.36 | 0.14 | 45.5 | 74 | -28.5 | peak |
| 4874.000 | 37.51 | 0.14 | 37.65 | 54 | -16.35 | AVG |
| 7311.000 | 40.72 | 2.36 | 43.08 | 74 | -30.92 | peak |
| 7311.000 | 33.66 | 2.36 | 36.02 | 54 | -17.98 | AVG |
| | | | | | | |
| | | | | | | |

Remark:
Factor = Antenna Factor + Cable Loss – Pre-amplifier.

RESULT: Pass

Any report having not been signed by authorized approver, or having been altered without authorization, or having not been stamped by the “Dedicated Testing/Inspection Stamp” is deemed to be invalid. Copying or excerpting portion of, or altering the content of the report is not permitted without the written authorization of AGC. The test results presented in the report apply only to the tested sample. Any objections to report issued by AGC should be submitted to AGC within 15days after the issuance of the test report. Further enquiry of validity or verification of the test report should be addressed to AGC by agc01@agccert.com.

Radiated Emissions Test Results above 1GHz

| | | | |
|--------------------|--|--------------------------|------------|
| EUT Name | Baseus Security P1 Lite Indoor Camera 2K | Model Name | S0TV00 |
| Temperature | 22.3°C | Relative Humidity | 59.9% |
| Pressure | 960hPa | Test Voltage | DC 5V |
| Test Mode | Mode 6 | Antenna Polarity | Horizontal |

| Frequency (MHz) | Meter Reading (dBµV) | Factor (dB) | Emission Level (dBµV/m) | Limits (dBµV/m) | Margin (dB) | Value Type |
|-----------------|----------------------|-------------|-------------------------|-----------------|-------------|------------|
| 4924.000 | 46.72 | 0.22 | 46.94 | 74 | -27.06 | peak |
| 4924.000 | 38.59 | 0.22 | 38.81 | 54 | -15.19 | AVG |
| 7386.000 | 41.36 | 2.64 | 44 | 74 | -30 | peak |
| 7386.000 | 32.89 | 2.64 | 35.53 | 54 | -18.47 | AVG |
| | | | | | | |
| | | | | | | |

Remark:
Factor = Antenna Factor + Cable Loss – Pre-amplifier.

| | | | |
|--------------------|--|--------------------------|----------|
| EUT Name | Baseus Security P1 Lite Indoor Camera 2K | Model Name | S0TV00 |
| Temperature | 22.3°C | Relative Humidity | 59.9% |
| Pressure | 960hPa | Test Voltage | DC 5V |
| Test Mode | Mode 6 | Antenna Polarity | Vertical |

| Frequency (MHz) | Meter Reading (dBµV) | Factor (dB) | Emission Level (dBµV/m) | Limits (dBµV/m) | Margin (dB) | Value Type |
|-----------------|----------------------|-------------|-------------------------|-----------------|-------------|------------|
| 4924.000 | 46.22 | 0.22 | 46.44 | 74 | -27.56 | peak |
| 4924.000 | 38.59 | 0.22 | 38.81 | 54 | -15.19 | AVG |
| 7386.000 | 40.82 | 2.64 | 43.46 | 74 | -30.54 | peak |
| 7386.000 | 31.69 | 2.64 | 34.33 | 54 | -19.67 | AVG |
| | | | | | | |
| | | | | | | |

Remark:
Factor = Antenna Factor + Cable Loss – Pre-amplifier.

RESULT: Pass

Any report having not been signed by authorized approver, or having been altered without authorization, or having not been stamped by the “Dedicated Testing/Inspection Stamp” is deemed to be invalid. Copying or excerpting portion of, or altering the content of the report is not permitted without the written authorization of AGC. The test results presented in the report apply only to the tested sample. Any objections to report issued by AGC should be submitted to AGC within 15days after the issuance of the test report. Further enquiry of validity or verification of the test report should be addressed to AGC by agc01@agccert.com.

Radiated Emissions Test Results above 1GHz

| | | | |
|--------------------|--|--------------------------|------------|
| EUT Name | Baseus Security P1 Lite Indoor Camera 2K | Model Name | S0TV00 |
| Temperature | 22.3°C | Relative Humidity | 59.9% |
| Pressure | 960hPa | Test Voltage | DC 5V |
| Test Mode | Mode 7 | Antenna Polarity | Horizontal |

| Frequency (MHz) | Meter Reading (dBμV) | Factor (dB) | Emission Level (dBμV/m) | Limits (dBμV/m) | Margin (dB) | Value Type |
|-----------------|----------------------|-------------|-------------------------|-----------------|-------------|------------|
| 4824.000 | 46.29 | 0.08 | 46.37 | 74 | -27.63 | peak |
| 4824.000 | 37.63 | 0.08 | 37.71 | 54 | -16.29 | AVG |
| 7236.000 | 41.72 | 2.21 | 43.93 | 74 | -30.07 | peak |
| 7236.000 | 32.65 | 2.21 | 34.86 | 54 | -19.14 | AVG |
| | | | | | | |
| | | | | | | |

Remark:
Factor = Antenna Factor + Cable Loss – Pre-amplifier.

| | | | |
|--------------------|--|--------------------------|----------|
| EUT Name | Baseus Security P1 Lite Indoor Camera 2K | Model Name | S0TV00 |
| Temperature | 22.3°C | Relative Humidity | 59.9% |
| Pressure | 960hPa | Test Voltage | DC 5V |
| Test Mode | Mode 7 | Antenna Polarity | Vertical |

| Frequency (MHz) | Meter Reading (dBμV) | Factor (dB) | Emission Level (dBμV/m) | Limits (dBμV/m) | Margin (dB) | Value Type |
|-----------------|----------------------|-------------|-------------------------|-----------------|-------------|------------|
| 4824.000 | 46.36 | 0.08 | 46.44 | 74 | -27.56 | peak |
| 4824.000 | 37.48 | 0.08 | 37.56 | 54 | -16.44 | AVG |
| 7236.000 | 41.39 | 2.21 | 43.6 | 74 | -30.4 | peak |
| 7236.000 | 32.41 | 2.21 | 34.62 | 54 | -19.38 | AVG |
| | | | | | | |
| | | | | | | |

Remark:
Factor = Antenna Factor + Cable Loss – Pre-amplifier.

RESULT: Pass

Any report having not been signed by authorized approver, or having been altered without authorization, or having not been stamped by the “Dedicated Testing/Inspection Stamp” is deemed to be invalid. Copying or excerpting portion of, or altering the content of the report is not permitted without the written authorization of AGC. The test results presented in the report apply only to the tested sample. Any objections to report issued by AGC should be submitted to AGC within 15days after the issuance of the test report. Further enquiry of validity or verification of the test report should be addressed to AGC by agc01@agccert.com.

Radiated Emissions Test Results above 1GHz

| | | | |
|--------------------|--|--------------------------|------------|
| EUT Name | Baseus Security P1 Lite Indoor Camera 2K | Model Name | S0TV00 |
| Temperature | 22.3°C | Relative Humidity | 59.9% |
| Pressure | 960hPa | Test Voltage | DC 5V |
| Test Mode | Mode 8 | Antenna Polarity | Horizontal |

| Frequency (MHz) | Meter Reading (dBµV) | Factor (dB) | Emission Level (dBµV/m) | Limits (dBµV/m) | Margin (dB) | Value Type |
|-----------------|----------------------|-------------|-------------------------|-----------------|-------------|------------|
| 4874.000 | 45.79 | 0.14 | 45.93 | 74 | -28.07 | peak |
| 4874.000 | 38.12 | 0.14 | 38.26 | 54 | -15.74 | AVG |
| 7311.000 | 41.65 | 2.36 | 44.01 | 74 | -29.99 | peak |
| 7311.000 | 34.27 | 2.36 | 36.63 | 54 | -17.37 | AVG |
| | | | | | | |
| | | | | | | |

Remark:
Factor = Antenna Factor + Cable Loss – Pre-amplifier.

| | | | |
|--------------------|--|--------------------------|----------|
| EUT Name | Baseus Security P1 Lite Indoor Camera 2K | Model Name | S0TV00 |
| Temperature | 22.3°C | Relative Humidity | 59.9% |
| Pressure | 960hPa | Test Voltage | DC 5V |
| Test Mode | Mode 8 | Antenna Polarity | Vertical |

| Frequency (MHz) | Meter Reading (dBµV) | Factor (dB) | Emission Level (dBµV/m) | Limits (dBµV/m) | Margin (dB) | Value Type |
|-----------------|----------------------|-------------|-------------------------|-----------------|-------------|------------|
| 4874.000 | 45.27 | 0.14 | 45.41 | 74 | -28.59 | peak |
| 4874.000 | 37.65 | 0.14 | 37.79 | 54 | -16.21 | AVG |
| 7311.000 | 40.96 | 2.36 | 43.32 | 74 | -30.68 | peak |
| 7311.000 | 33.72 | 2.36 | 36.08 | 54 | -17.92 | AVG |
| | | | | | | |
| | | | | | | |

Remark:
Factor = Antenna Factor + Cable Loss – Pre-amplifier.

RESULT: Pass

Any report having not been signed by authorized approver, or having been altered without authorization, or having not been stamped by the “Dedicated Testing/Inspection Stamp” is deemed to be invalid. Copying or excerpting portion of, or altering the content of the report is not permitted without the written authorization of AGC. The test results presented in the report apply only to the tested sample. Any objections to report issued by AGC should be submitted to AGC within 15days after the issuance of the test report. Further enquiry of validity or verification of the test report should be addressed to AGC by agc01@agccert.com.

Radiated Emissions Test Results above 1GHz

| | | | |
|--------------------|--|--------------------------|------------|
| EUT Name | Baseus Security P1 Lite Indoor Camera 2K | Model Name | S0TV00 |
| Temperature | 22.3°C | Relative Humidity | 59.9% |
| Pressure | 960hPa | Test Voltage | DC 5V |
| Test Mode | Mode 9 | Antenna Polarity | Horizontal |

| Frequency (MHz) | Meter Reading (dBμV) | Factor (dB) | Emission Level (dBμV/m) | Limits (dBμV/m) | Margin (dB) | Value Type |
|-----------------|----------------------|-------------|-------------------------|-----------------|-------------|------------|
| 4924.000 | 46.54 | 0.22 | 46.76 | 74 | -27.24 | peak |
| 4924.000 | 38.45 | 0.22 | 38.67 | 54 | -15.33 | AVG |
| 7386.000 | 41.26 | 2.64 | 43.9 | 74 | -30.1 | peak |
| 7386.000 | 32.87 | 2.64 | 35.51 | 54 | -18.49 | AVG |
| | | | | | | |
| | | | | | | |

Remark:
Factor = Antenna Factor + Cable Loss – Pre-amplifier.

| | | | |
|--------------------|--|--------------------------|----------|
| EUT Name | Baseus Security P1 Lite Indoor Camera 2K | Model Name | S0TV00 |
| Temperature | 22.3°C | Relative Humidity | 59.9% |
| Pressure | 960hPa | Test Voltage | DC 5V |
| Test Mode | Mode 9 | Antenna Polarity | Vertical |

| Frequency (MHz) | Meter Reading (dBμV) | Factor (dB) | Emission Level (dBμV/m) | Limits (dBμV/m) | Margin (dB) | Value Type |
|-----------------|----------------------|-------------|-------------------------|-----------------|-------------|------------|
| 4924.000 | 46.11 | 0.22 | 46.33 | 74 | -27.67 | peak |
| 4924.000 | 38.55 | 0.22 | 38.77 | 54 | -15.23 | AVG |
| 7386.000 | 40.76 | 2.64 | 43.4 | 74 | -30.6 | peak |
| 7386.000 | 31.93 | 2.64 | 34.57 | 54 | -19.43 | AVG |
| | | | | | | |
| | | | | | | |

Remark:
Factor = Antenna Factor + Cable Loss – Pre-amplifier.

RESULT: Pass

Note:

1. The amplitude of other spurious emissions from 1G to 25 GHz which are attenuated more than 20 dB below the permissible value need not be reported.
2. Factor = Antenna Factor + Cable loss – Pre-amplifier gain, Margin =Emission Level-Limit.
3. The “Factor” value can be calculated automatically by software of measurement system.

Any report having not been signed by authorized approver, or having been altered without authorization, or having not been stamped by the “Dedicated Testing/Inspection Stamp” is deemed to be invalid. Copying or excerpting portion of, or altering the content of the report is not permitted without the written authorization of AGC. The test results presented in the report apply only to the tested sample. Any objections to report issued by AGC should be submitted to AGC within 15days after the issuance of the test report. Further enquiry of validity or verification of the test report should be addressed to AGC by agc01@agccert.com.

Band Edge Emission Test Results for Restricted Bands

| | | | |
|--------------------|--|--------------------------|------------|
| EUT Name | Baseus Security P1 Lite Indoor Camera 2K | Model Name | S0TV00 |
| Temperature | 22.3°C | Relative Humidity | 59.9% |
| Pressure | 960hPa | Test Voltage | DC 5V |
| Test Mode | Mode 1 | Antenna Polarity | Horizontal |

Test Graph for Peak Measurement



Test Graph for Average Measurement

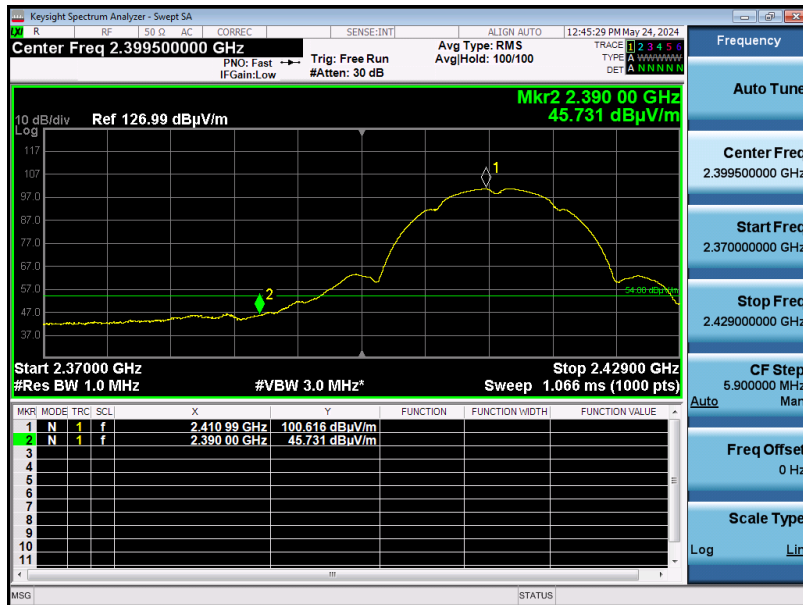

RESULT: Pass

Any report having not been signed by authorized approver, or having been altered without authorization, or having not been stamped by the "Dedicated Testing/Inspection Stamp" is deemed to be invalid. Copying or excerpting portion of, or altering the content of the report is not permitted without the written authorization of AGC. The test results presented in the report apply only to the tested sample. Any objections to report issued by AGC should be submitted to AGC within 15days after the issuance of the test report. Further enquiry of validity or verification of the test report should be addressed to AGC by agc01@agccert.com.

Band Edge Emission Test Results for Restricted Bands

| | | | |
|--------------------|--|--------------------------|----------|
| EUT Name | Baseus Security P1 Lite Indoor Camera 2K | Model Name | S0TV00 |
| Temperature | 22.3°C | Relative Humidity | 59.9% |
| Pressure | 960hPa | Test Voltage | DC 5V |
| Test Mode | Mode 1 | Antenna Polarity | Vertical |

Test Graph for Peak Measurement



Test Graph for Average Measurement

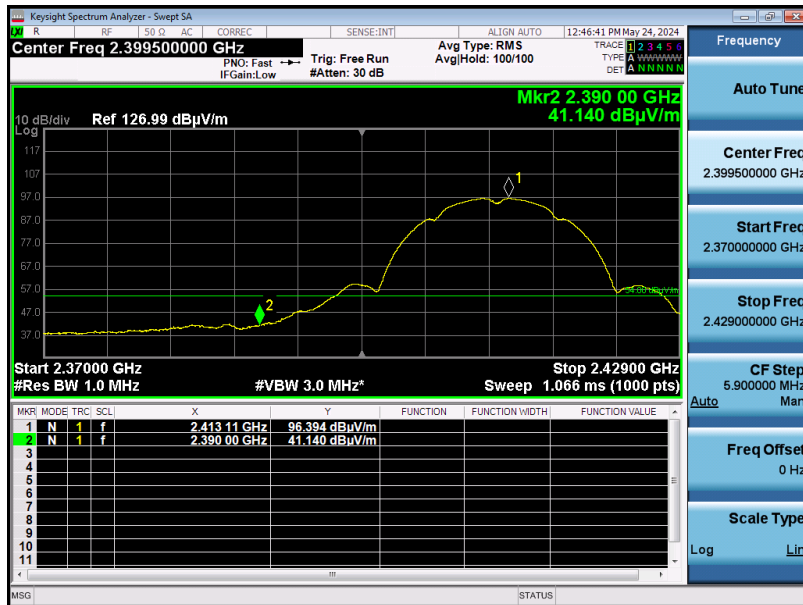

RESULT: Pass

Any report having not been signed by authorized approver, or having been altered without authorization, or having not been stamped by the "Dedicated Testing/Inspection Stamp" is deemed to be invalid. Copying or excerpting portion of, or altering the content of the report is not permitted without the written authorization of AGC. The test results presented in the report apply only to the tested sample. Any objections to report issued by AGC should be submitted to AGC within 15days after the issuance of the test report. Further enquiry of validity or verification of the test report should be addressed to AGC by agc01@agccert.com.

Band Edge Emission Test Results for Restricted Bands

| | | | |
|--------------------|--|--------------------------|------------|
| EUT Name | Baseus Security P1 Lite Indoor Camera 2K | Model Name | S0TV00 |
| Temperature | 22.3°C | Relative Humidity | 59.9% |
| Pressure | 960hPa | Test Voltage | DC 5V |
| Test Mode | Mode 3 | Antenna Polarity | Horizontal |

Test Graph for Peak Measurement



Test Graph for Average Measurement

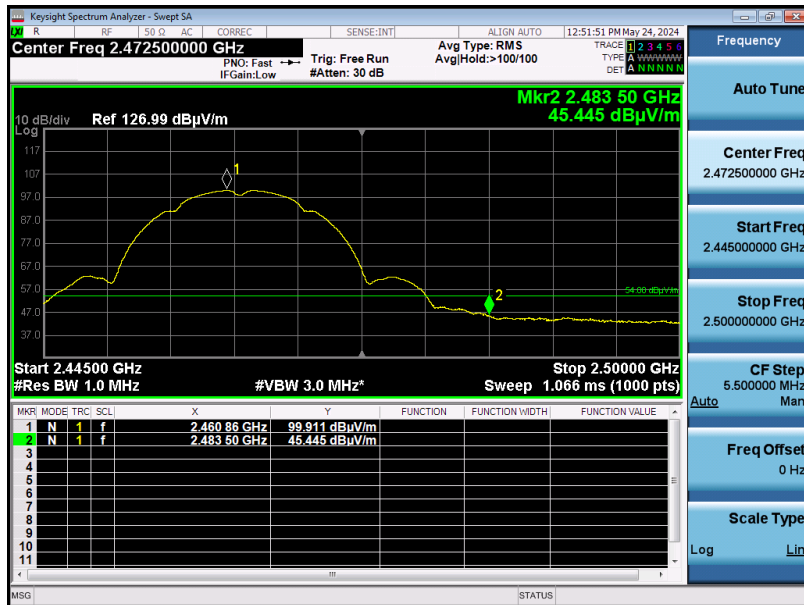

RESULT: Pass

Any report having not been signed by authorized approver, or having been altered without authorization, or having not been stamped by the "Dedicated Testing/Inspection Stamp" is deemed to be invalid. Copying or excerpting portion of, or altering the content of the report is not permitted without the written authorization of AGC. The test results presented in the report apply only to the tested sample. Any objections to report issued by AGC should be submitted to AGC within 15days after the issuance of the test report. Further enquiry of validity or verification of the test report should be addressed to AGC by agc01@agccert.com.

Attestation of Global Compliance(Shenzhen)Co., Ltd
Attestation of Global Compliance(Shenzhen)Std & Tech Co., Ltd
Tel: +86-755 2523 4088 E-mail: agc@agccert.com Web: http://www.agccert.com/

Band Edge Emission Test Results for Restricted Bands

| | | | |
|--------------------|--|--------------------------|----------|
| EUT Name | Baseus Security P1 Lite Indoor Camera 2K | Model Name | S0TV00 |
| Temperature | 22.3°C | Relative Humidity | 59.9% |
| Pressure | 960hPa | Test Voltage | DC 5V |
| Test Mode | Mode 3 | Antenna Polarity | Vertical |

Test Graph for Peak Measurement



Test Graph for Average Measurement

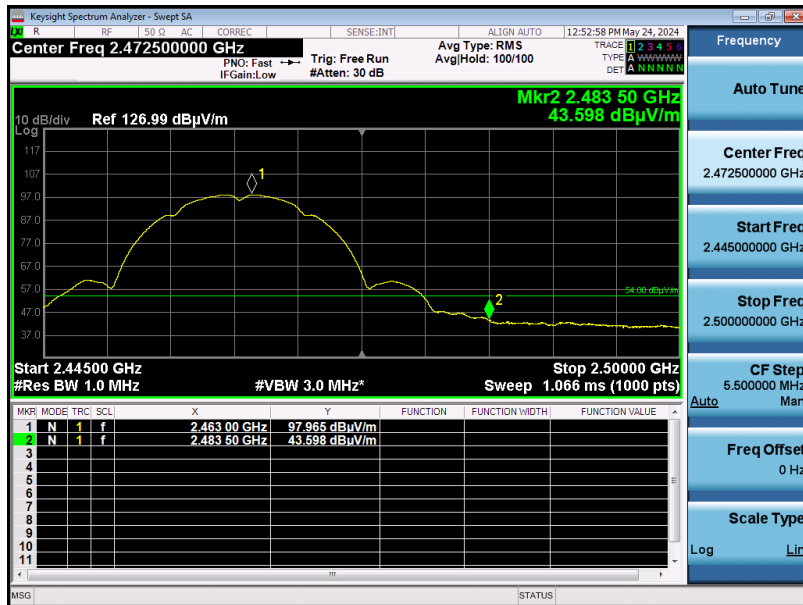

RESULT: Pass

Any report having not been signed by authorized approver, or having been altered without authorization, or having not been stamped by the “Dedicated Testing/Inspection Stamp” is deemed to be invalid. Copying or excerpting portion of, or altering the content of the report is not permitted without the written authorization of AGC. The test results presented in the report apply only to the tested sample. Any objections to report issued by AGC should be submitted to AGC within 15days after the issuance of the test report. Further enquiry of validity or verification of the test report should be addressed to AGC by agc01@agccert.com.

Band Edge Emission Test Results for Restricted Bands

| | | | |
|--------------------|--|--------------------------|------------|
| EUT Name | Baseus Security P1 Lite Indoor Camera 2K | Model Name | S0TV00 |
| Temperature | 22.3°C | Relative Humidity | 59.9% |
| Pressure | 960hPa | Test Voltage | DC 5V |
| Test Mode | Mode 4 | Antenna Polarity | Horizontal |

Test Graph for Peak Measurement



Test Graph for Average Measurement

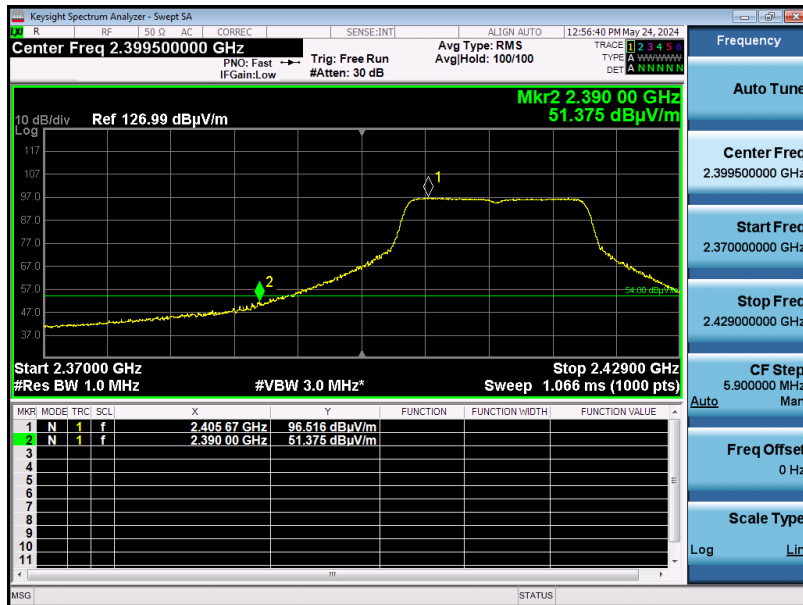

RESULT: Pass

Any report having not been signed by authorized approver, or having been altered without authorization, or having not been stamped by the “Dedicated Testing/Inspection Stamp” is deemed to be invalid. Copying or excerpting portion of, or altering the content of the report is not permitted without the written authorization of AGC. The test results presented in the report apply only to the tested sample. Any objections to report issued by AGC should be submitted to AGC within 15days after the issuance of the test report. Further enquiry of validity or verification of the test report should be addressed to AGC by agc01@agccert.com.

Band Edge Emission Test Results for Restricted Bands

| | | | |
|--------------------|--|--------------------------|----------|
| EUT Name | Baseus Security P1 Lite Indoor Camera 2K | Model Name | S0TV00 |
| Temperature | 22.3°C | Relative Humidity | 59.9% |
| Pressure | 960hPa | Test Voltage | DC 5V |
| Test Mode | Mode 4 | Antenna Polarity | Vertical |

Test Graph for Peak Measurement



Test Graph for Average Measurement

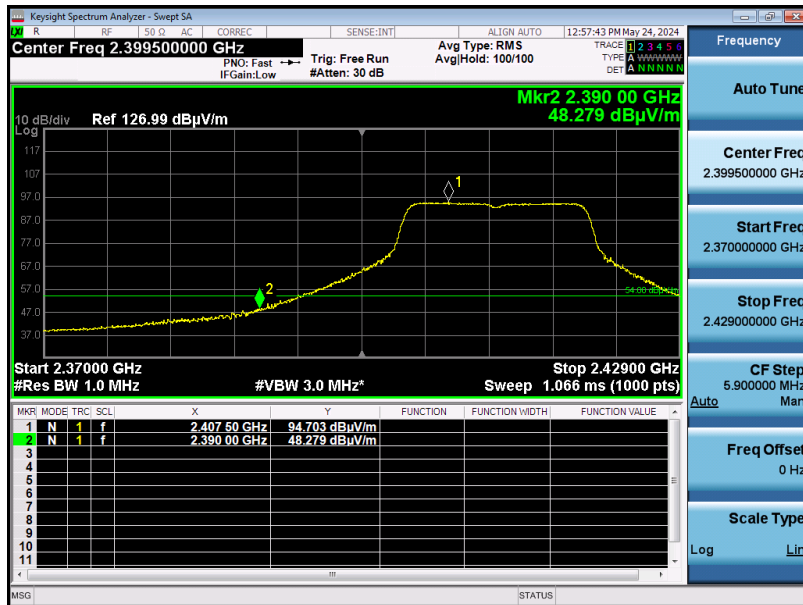

RESULT: Pass

Any report having not been signed by authorized approver, or having been altered without authorization, or having not been stamped by the "Dedicated Testing/Inspection Stamp" is deemed to be invalid. Copying or excerpting portion of, or altering the content of the report is not permitted without the written authorization of AGC. The test results presented in the report apply only to the tested sample. Any objections to report issued by AGC should be submitted to AGC within 15days after the issuance of the test report. Further enquiry of validity or verification of the test report should be addressed to AGC by agc01@agccert.com.