

# TEST REPORT

Report No.: BCTC2312656756-1E

---

Applicant: Shenzhen Baseus Technology Co., Ltd.

---

Product Name: Power Bank

---

Test Model: PPCXM1030

---

Tested Date: 2023-12-12 to 2023-12-18

---

Issued Date: 2023-12-18

---

**Shenzhen BCTC Testing Co., Ltd.**



# FCC ID: 2A482-PPCXM1030A

Product Name: Power Bank  
Trademark: baseus  
Model/Type Reference: PPCXM1030  
Prepared For: Shenzhen Baseus Technology Co., Ltd.  
Address: 2nd Floor, Building B, Baseus Intelligence Park, No.2008, Xuegang Rd, Gangtou Community, Bantian Street, Longgang District, Shenzhen, China  
Manufacturer: Shenzhen Baseus Technology Co., Ltd.  
Address: 2nd Floor, Building B, Baseus Intelligence Park, No.2008, Xuegang Rd, Gangtou Community, Bantian Street, Longgang District, Shenzhen, China  
Prepared By: Shenzhen BCTC Testing Co., Ltd.  
Address: 1-2/F., Building B, Pengzhou Industrial Park, No.158, Fuyuan 1st Road, Zhancheng, Fuhai Subdistrict, Bao'an District, Shenzhen, Guangdong, China.  
Sample Received Date: 2023-12-12  
Sample Tested Date: 2023-12-12 to 2023-12-18  
Issue Date: 2023-12-18  
Report No.: BCTC2312656756-1E  
Test Standards: FCC Part15.209  
ANSI C63.10-2013  
Test Results: PASS

Tested by:

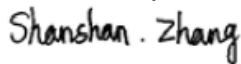

Shanshan. Zhang / Project Handler

Approved by:



Zero Zhou/Reviewer

The test report is effective only with both signature and specialized stamp. This result(s) shown in this report refer only to the sample(s) tested. Without written approval of Shenzhen BCTC Testing Co., Ltd, this report can't be reproduced except in full. The tested sample(s) and the sample information are provided by the client.

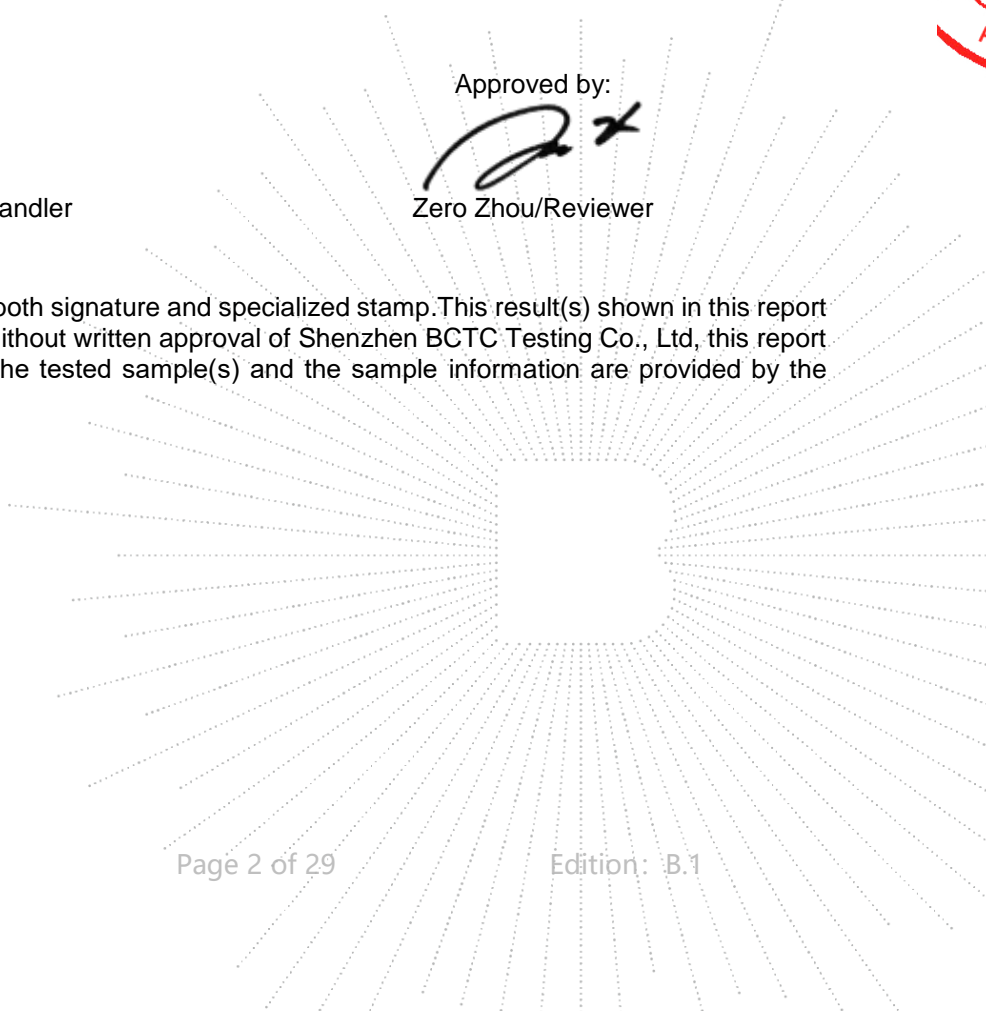

## Table Of Content

	Page
Test Report Declaration	
1. Version .....	4
2. Test Summary .....	5
3. Measurement Uncertainty .....	6
4. Product Information And Test Setup .....	7
4.1 Product Information .....	7
4.2 Support Equipment .....	7
4.3 Test Setup Configuration .....	8
4.4 Test Mode .....	9
5. Test Facility And Test Instrument Used .....	10
5.1 Test Facility .....	10
5.2 Test Instrument Used .....	10
6. Conducted Emissions .....	12
6.1 Block Diagram Of Test Setup .....	12
6.2 Limit .....	12
6.3 Test procedure .....	12
6.4 EUT operating Conditions .....	12
6.5 Test Result .....	13
7. Radiated Emissions .....	15
7.1 Block Diagram Of Test Setup .....	15
7.2 Limit .....	16
7.3 Test procedure .....	16
7.4 Test Result .....	17
8. Bandwidth Test .....	23
8.1 Test Procedure .....	23
8.2 Test Setup .....	23
8.3 Test Result .....	23
9. Antenna Requirements .....	24
9.1 Limit .....	24
9.2 Test Result .....	24
10. EUT Photographs .....	25
11. EUT Test Setup Photographs .....	26

(Note: N/A Means Not Applicable)

**1. Version**

Report No.	Issue Date	Description	Approved
BCTC2312656756-1E	2023-12-18	Original	Valid

TEC  
TC  
OVB  
t Sea

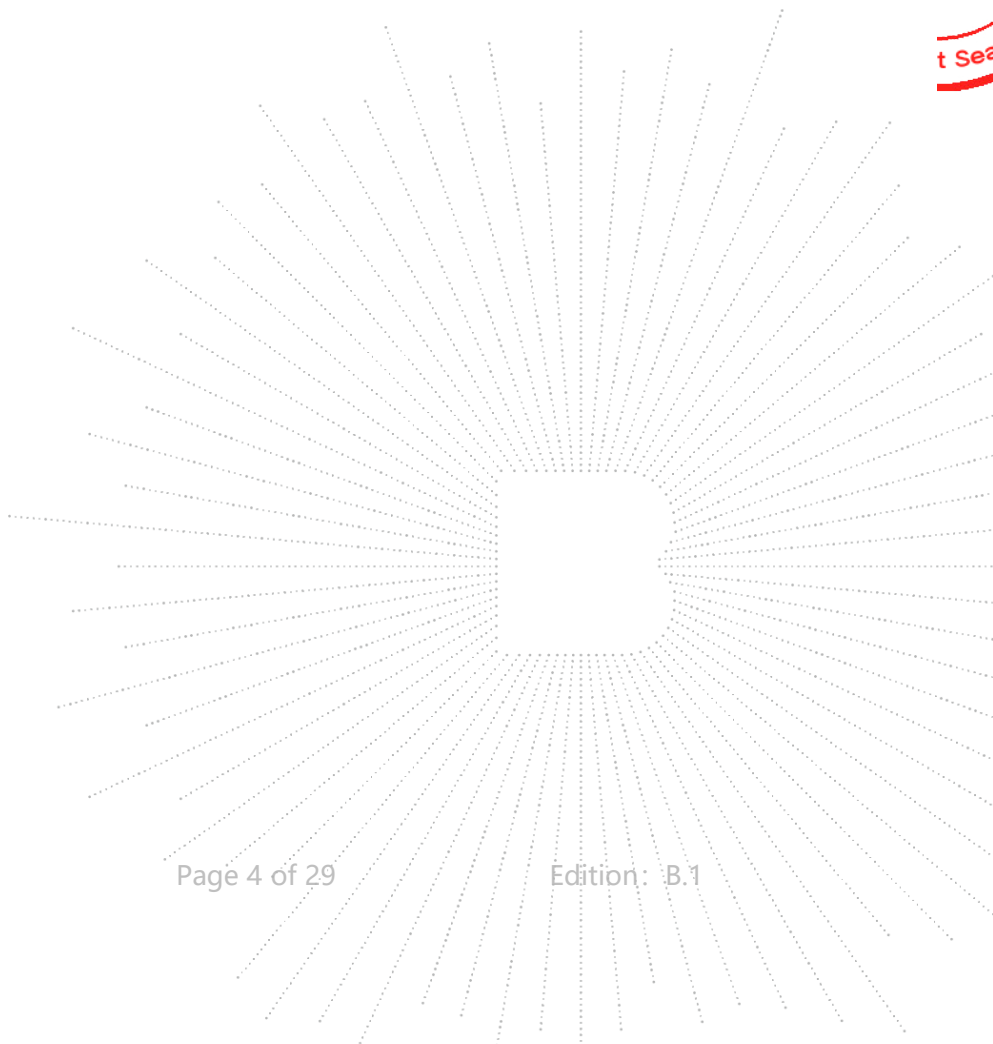

## 2. Test Summary

The Product has been tested according to the following specifications:

No.	Test Parameter	Clause No.	Results
1	Conducted Emission	15.207	PASS
2	Radiated Emission	15.209	PASS
3	20dB Bandwidth	15.215	PASS
4	Antenna Requirement	15.203	PASS

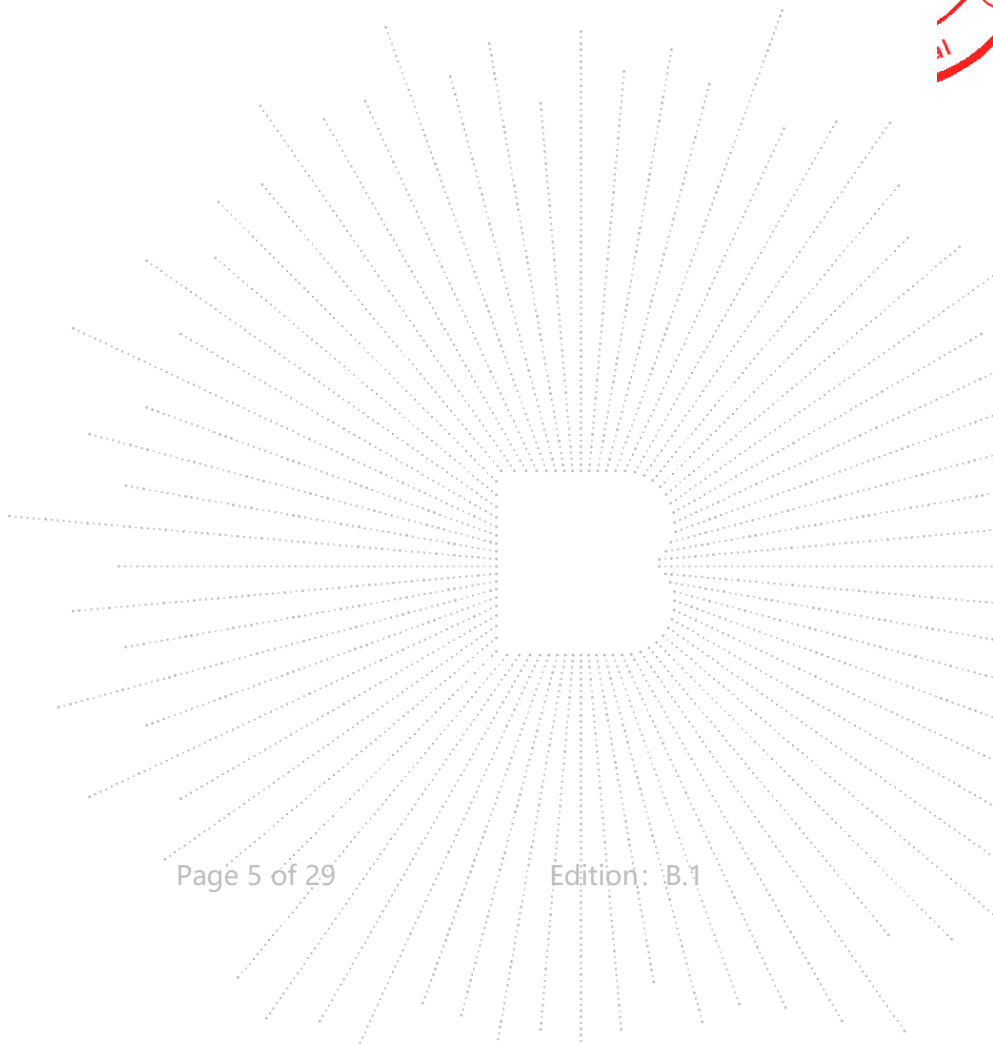

### 3. Measurement Uncertainty

Where relevant, the following measurement uncertainty levels have been estimated for tests performed on the Product as specified in CISPR 16-4-2. This uncertainty represents an expanded uncertainty expressed at approximately the 95% confidence level using a coverage factor of  $k=2$ .

No.	Item	Uncertainty
1	3m chamber Radiated spurious emission(30MHz-1GHz)	U=4.3dB
2	Conducted Emission (150kHz-30MHz)	U=3.2dB
3	humidity uncertainty	U=5.3%
4	Temperature uncertainty	U=0.59°C

CO., LTD

## 4. Product Information And Test Setup

### 4.1 Product Information

Model/Type Reference: PPCXM1030  
 Model Differences: N/A  
 Hardware Version: N/A  
 Software Version: N/A  
 Operation Frequency: 115kHz-205kHz  
 Modulation: ASK  
 Antenna installation: coil antenna  
 Ratings: Type C Input: DC 5V/3A or DC 9V/2A or DC 12V/1.5A  
           Type C Output: DC 5V/3A, 9V/3A, 12V/2.5A, 15V/2A  
           Wireless Output: 5W/7.5W/10W/15W  
           Total Output: 5V/3A(Wireless charging and type C charging work simultaneously)  
           Battery: DC 3.7V

### 4.2 Support Equipment

No.	Device Type	Brand	Model	Series No.	Note
E-1	Power Bank	N/A	PPCXM1030	N/A	EUT
E-2	ADAPTER	Hoco.	N18	N/A	Auxiliary
E-3	Dummy load	N/A	DL01	N/A	Auxiliary

Notes:

1. All the equipment/cables were placed in the worst-case configuration to maximize the emission during the test.
2. Grounding was established in accordance with the manufacturer's requirements and conditions for the intended use.



### 4.3 Test Setup Configuration

See test photographs attached in *EUT TEST SETUP PHOTOGRAPHS* for the actual connections between Product and support equipment.

Conducted Emission:

Test Mode 1, 2, 3

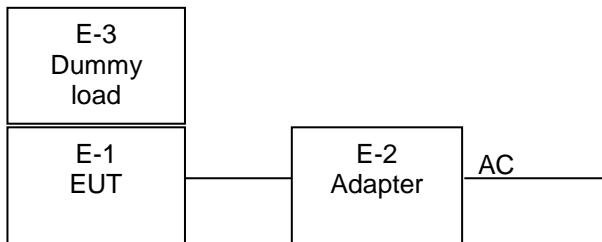

Radiated Spurious Emission:

Test Mode 1, 2, 3

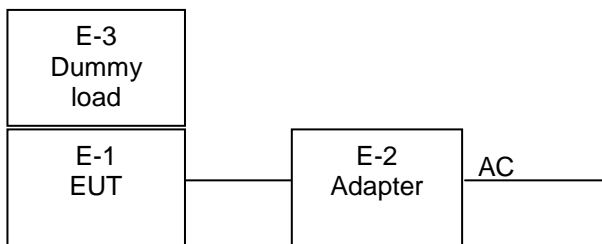

Test Mode 4, 5, 6

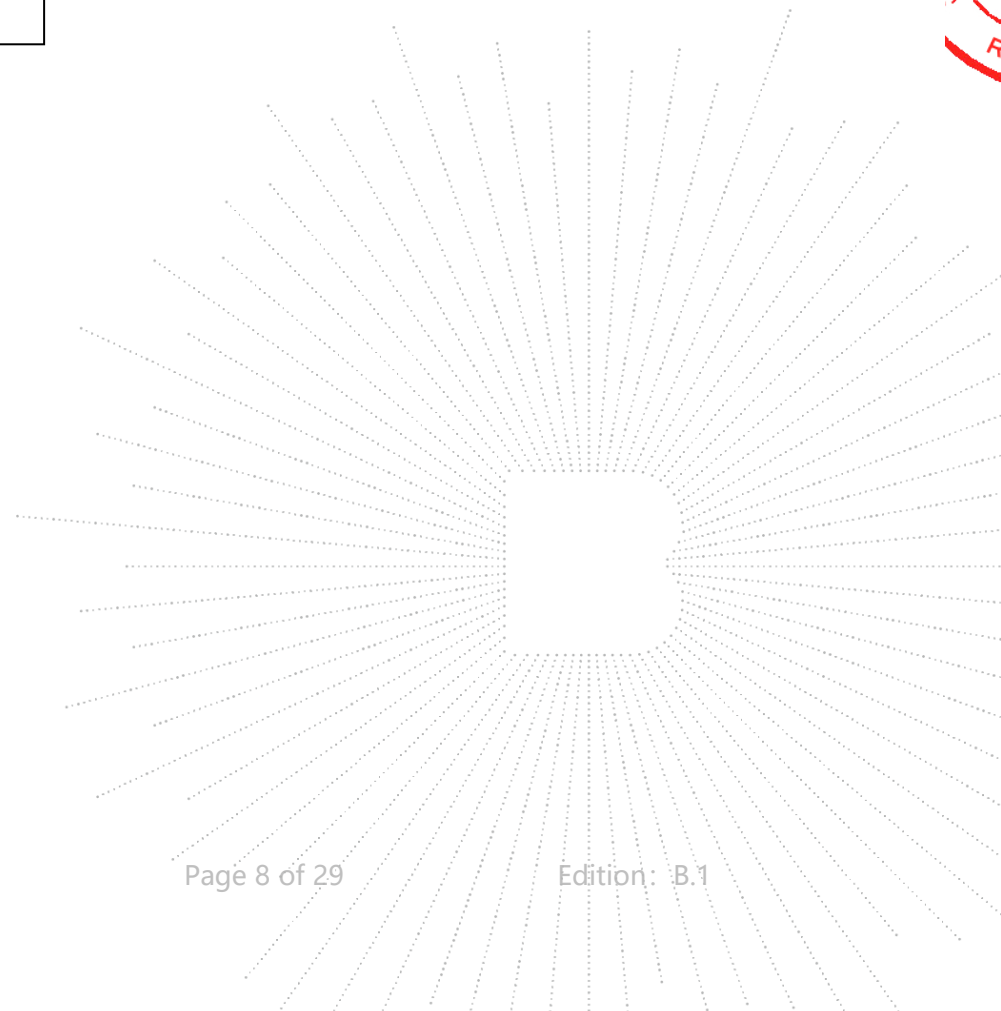
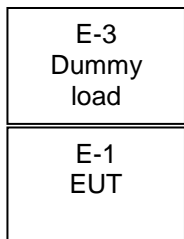



#### 4.4 Test Mode

To investigate the maximum EMI emission characteristics generates from EUT, the test system was pre-scanning tested base on the consideration of following EUT operation mode or test configuration mode which possible have effect on EMI emission level. Each of these EUT operation mode(s) or test configuration mode(s) mentioned above was evaluated respectively.

AC Mode	Mode 1	Wireless charging(Full load)
	Mode 2	Wireless charging(Half load)
	Mode 3	Wireless charging(Empty load)
DC Mode	Mode 4	Wireless charging(Full load)
	Mode 5	Wireless charging(Half load)
	Mode 6	Wireless charging(Empty load)

Note: All test mode were tested and passed, only shows the worst case mode which were recorded in this report.

BCTC  
 BCTC  
 PPR  
 Report

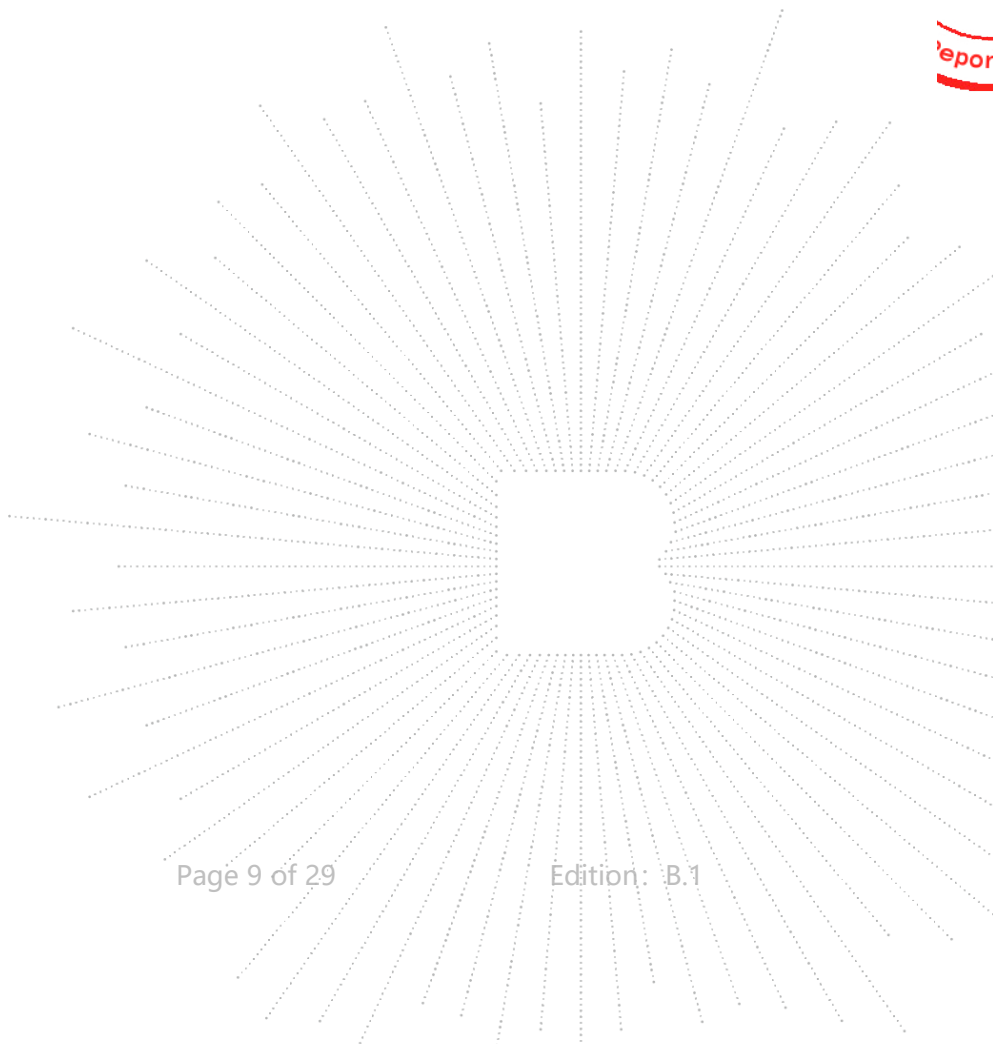

## 5. Test Facility And Test Instrument Used

### 5.1 Test Facility

All measurement facilities used to collect the measurement data are located at Shenzhen BCTC Testing Co., Ltd. Address:1-2/F., Building B, Pengzhou Industrial Park, No.158, Fuyuan 1st Road, Zhancheng, Fuhai Subdistrict, Bao'an District, Shenzhen, Guangdong, China. The site and apparatus are constructed in conformance with the requirements of ANSI C63.4 and CISPR 16-1-1 other equivalent standards.

FCC Test Firm Registration Number: 712850

FCC Designation Number: CN1212

ISED Registered No.: 23583

ISED CAB identifier: CN0017

### 5.2 Test Instrument Used

Conducted Emissions Test					
Equipment	Manufacturer	Model#	Serial#	Last Cal.	Next Cal.
Receiver	R&S	ESR3	102075	May 15, 2023	May 14, 2024
LISN	R&S	ENV216	101375	May 15, 2023	May 14, 2024
Software	Frad	EZ-EMC	EMC-CON 3A1	\	\
Pulse limiter	Schwarzbeck	VTSD9561-F	01323	Sept. 22, 2023	Sept. 21, 2024

RF Conducted Test					
Equipment	Manufacturer	Model#	Serial#	Last Cal.	Next Cal.
Power Meter	Keysight	E4419	\	May 15, 2023	May 14, 2024
Power Sensor (AV)	Keysight	E9300A	\	May 15, 2023	May 14, 2024
Signal Analyzer 20kHz-26.5G Hz	Keysight	N9020A	MY49100060	May 15, 2023	May 14, 2024
Spectrum Analyzer 9kHz-40GHz	R&S	FSP 40	\	May 15, 2023	May 14, 2024

Radiated Emissions Test (966 Chamber01)					
Equipment	Manufacturer	Model#	Serial#	Last Cal.	Next Cal.
966 chamber	ChengYu	966 Room	966	May 15, 2023	May 14, 2026
Receiver	R&S	ESR3	102075	May 15, 2023	May 14, 2024
Receiver	R&S	ESRP	101154	May 15, 2023	May 14, 2024
Amplifier	Schwarzbeck	BBV9744	9744-0037	May 15, 2023	May 14, 2024
TRILOG Broadband Antenna	Schwarzbeck	VULB9163	942	May 29, 2023	May 28, 2024
Loop Antenna(9KHz -30MHz)	Schwarzbeck	FMZB1519B	00014	May 31, 2023	May 30, 2024
Amplifier	SKET	LAPA_01G18 G-45dB	\	May 15, 2023	May 14, 2024
Horn Antenna	Schwarzbeck	BBHA9120D	1541	May 31, 2023	May 30, 2024
Amplifier(18G Hz-40GHz)	MITEQ	TTA1840-35-HG	2034381	May 15, 2023	May 14, 2024
Horn Antenna(18G Hz-40GHz)	Schwarzbeck	BBHA9170	00822	May 31, 2023	May 30, 2024
Spectrum Analyzer9kHz-40GHz	R&S	FSP40	100363	May 15, 2023	May 14, 2024
Software	Frad	EZ-EMC	FA-03A2 RE	\	\

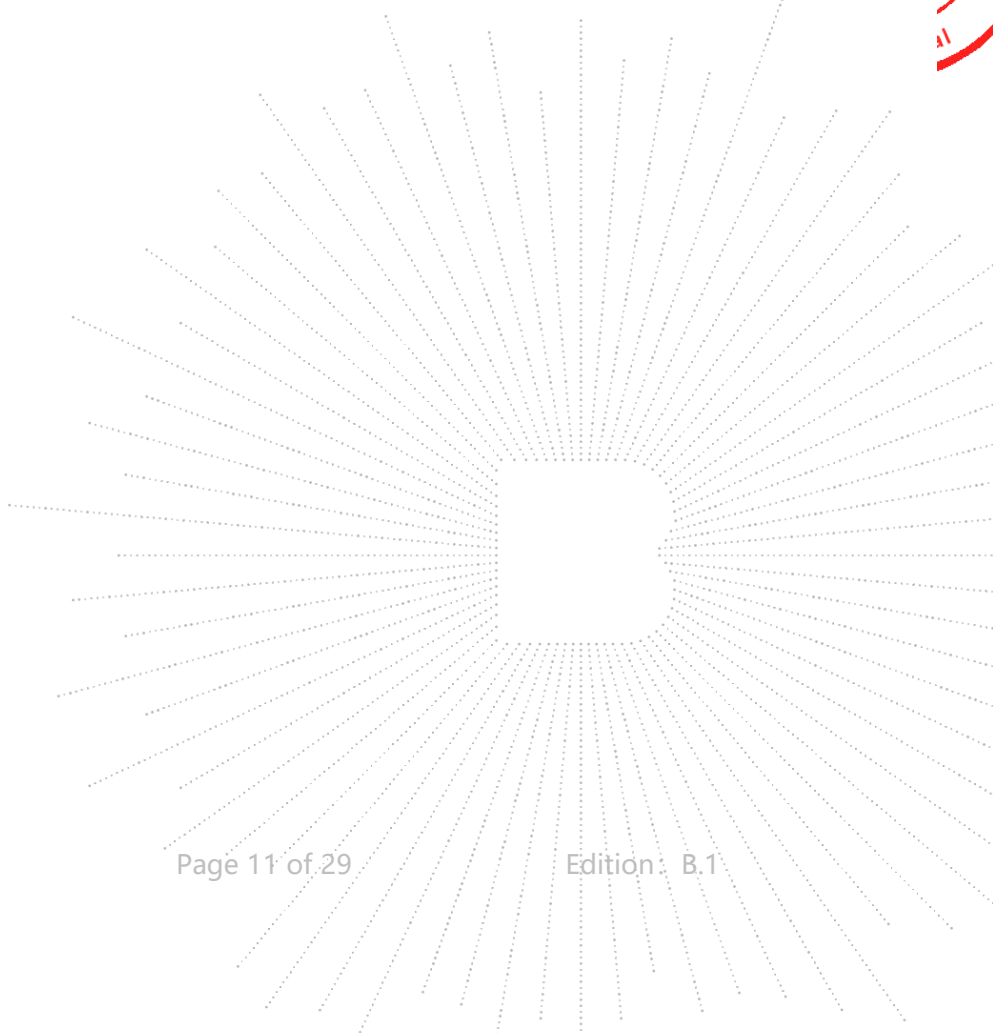

## 6. Conducted Emissions

### 6.1 Block Diagram Of Test Setup

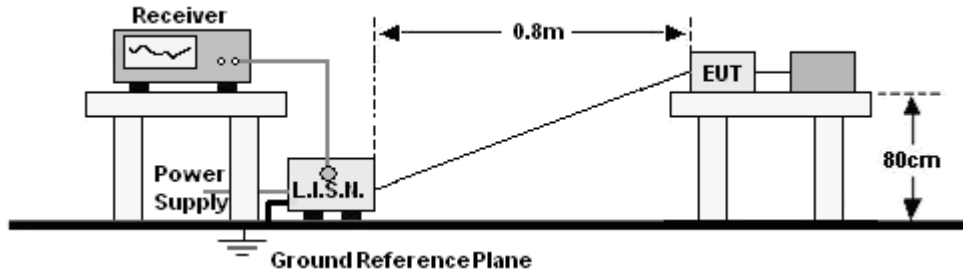

### 6.2 Limit

Frequency (MHz)	Limit (dBuV)	
	Quas-peak	Average
0.15 -0.5	66 - 56 *	56 - 46 *
0.50 -5.0	56.00	46.00
5.0 -30.0	60.00	50.00

Notes:  
 1. \*Decreasing linearly with logarithm of frequency.  
 2. The lower limit shall apply at the transition frequencies.

### 6.3 Test procedure

Receiver Parameters	Setting
Attenuation	10 dB
Start Frequency	0.15 MHz
Stop Frequency	30 MHz
IF Bandwidth	9 kHz

- The Product was placed on a nonconductive table 0.8 m above the horizontal ground reference plane, and 0.4 m from the vertical ground reference plane, and connected to the main through Line Impedance Stability Network (L.I.S.N).
- The RBW of the receiver was set at 9 kHz in 150 kHz ~ 30MHz with Peak and AVG detector in Max Hold mode. Run the receiver's pre-scan to record the maximum disturbance generated from Product in all power lines in the full band.
- For each frequency whose maximum record was higher or close to limit, measure its QP and AVG values and record.

### 6.4 EUT operating Conditions

The EUT was configured for testing in a typical fashion (as a customer would normally use it). The EUT has been programmed to continuously transmit during test. This operating condition was tested and used to collect the included data.

### 6.5 Test Result

Temperature:	26 °C	Relative Humidity:	54%
Pressure:	101KPa	Phase :	L
Test Mode:	Mode 1	Test Voltage:	AC 120V/60Hz

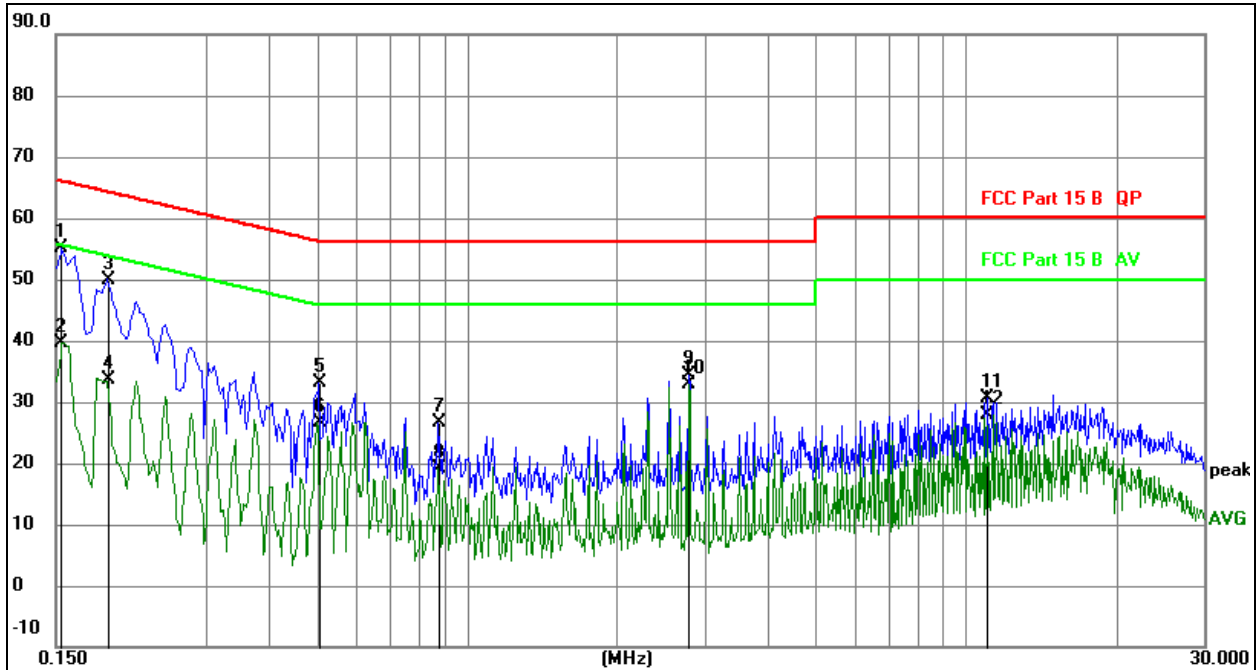

**Remark:**

1. All readings are Quasi-Peak and Average values.
2. Factor = Insertion Loss + Cable Loss.
3. Measurement = Reading Level + Correct Factor
4. Over = Measurement - Limit

No.	Mk.	Freq. MHz	Reading Level	Correct Factor dB	Measure- ment dBuV	Limit dBuV	Over dB	Detector
1	*	0.1539	35.45	19.74	55.19	65.79	-10.60	QP
2		0.1539	19.92	19.74	39.66	55.79	-16.13	AVG
3		0.1904	30.19	19.81	50.00	64.02	-14.02	QP
4		0.1904	13.89	19.81	33.70	54.02	-20.32	AVG
5		0.5047	13.18	19.84	33.02	56.00	-22.98	QP
6		0.5047	6.70	19.84	26.54	46.00	-19.46	AVG
7		0.8757	6.81	19.90	26.71	56.00	-29.29	QP
8		0.8757	-0.66	19.90	19.24	46.00	-26.76	AVG
9		2.7794	14.05	20.23	34.28	56.00	-21.72	QP
10		2.7794	12.74	20.23	32.97	46.00	-13.03	AVG
11		11.0211	10.66	19.88	30.54	60.00	-29.46	QP
12		11.0211	7.96	19.88	27.84	50.00	-22.16	AVG

Temperature:	26 °C	Relative Humidity:	54%
Pressure:	101KPa	Phase :	N
Test Mode:	Mode 1	Test Voltage:	AC 120V/60Hz

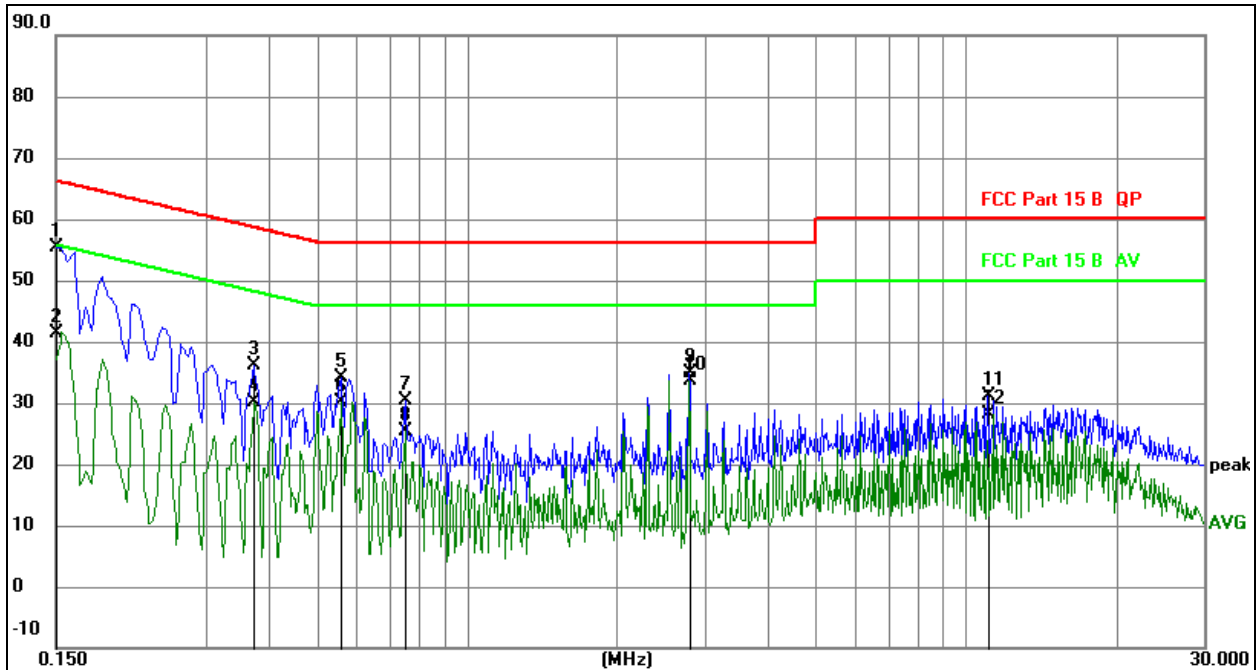
**Remark:**

1. All readings are Quasi-Peak and Average values.
2. Factor = Insertion Loss + Cable Loss.
3. Measurement = Reading Level + Correct Factor
4. Over = Measurement - Limit

No.	Mk.	Freq. MHz	Reading Level	Correct Factor dB	Measure- ment dBuV	Limit dBuV	Over dB	Detector
1	*	0.1500	35.59	19.73	55.32	66.00	-10.68	QP
2		0.1500	21.77	19.73	41.50	56.00	-14.50	AVG
3		0.3750	16.22	19.84	36.06	58.39	-22.33	QP
4		0.3750	10.39	19.84	30.23	48.39	-18.16	AVG
5		0.5595	14.17	19.84	34.01	56.00	-21.99	QP
6		0.5595	10.38	19.84	30.22	46.00	-15.78	AVG
7		0.7530	10.53	19.86	30.39	56.00	-25.61	QP
8		0.7530	5.63	19.86	25.49	46.00	-20.51	AVG
9		2.7915	14.58	20.23	34.81	56.00	-21.19	QP
10		2.7915	13.34	20.23	33.57	46.00	-12.43	AVG
11		11.0535	11.15	19.88	31.03	60.00	-28.97	QP
12		11.0535	8.29	19.88	28.17	50.00	-21.83	AVG

## 7. Radiated Emissions

### 7.1 Block Diagram Of Test Setup

(A) Radiated Emission Test-Up Frequency Below 30MHz

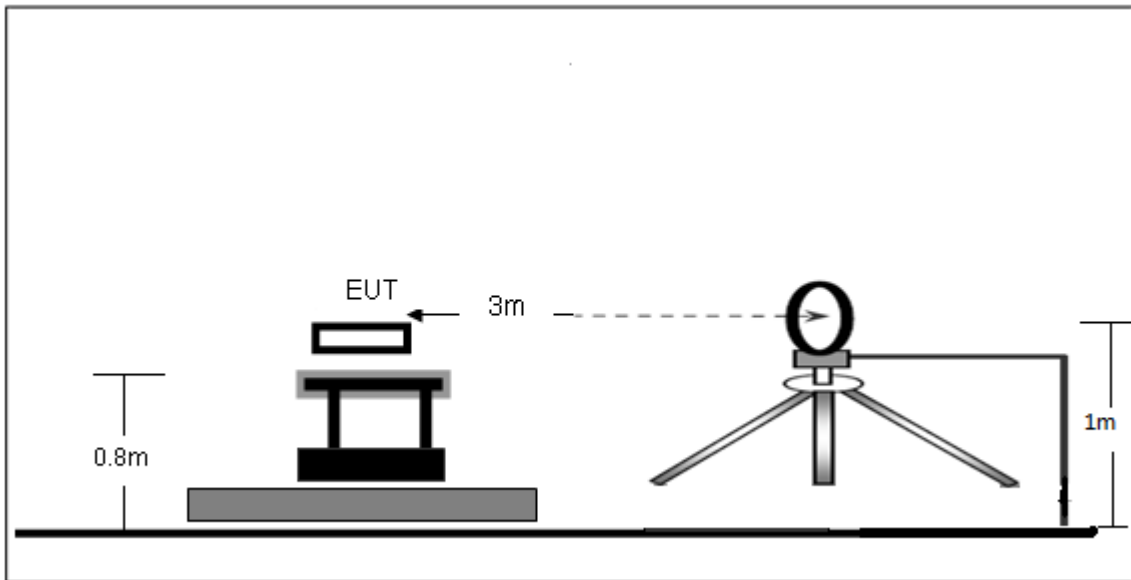

(B) Radiated Emission Test-Up Frequency 30MHz~1GHz

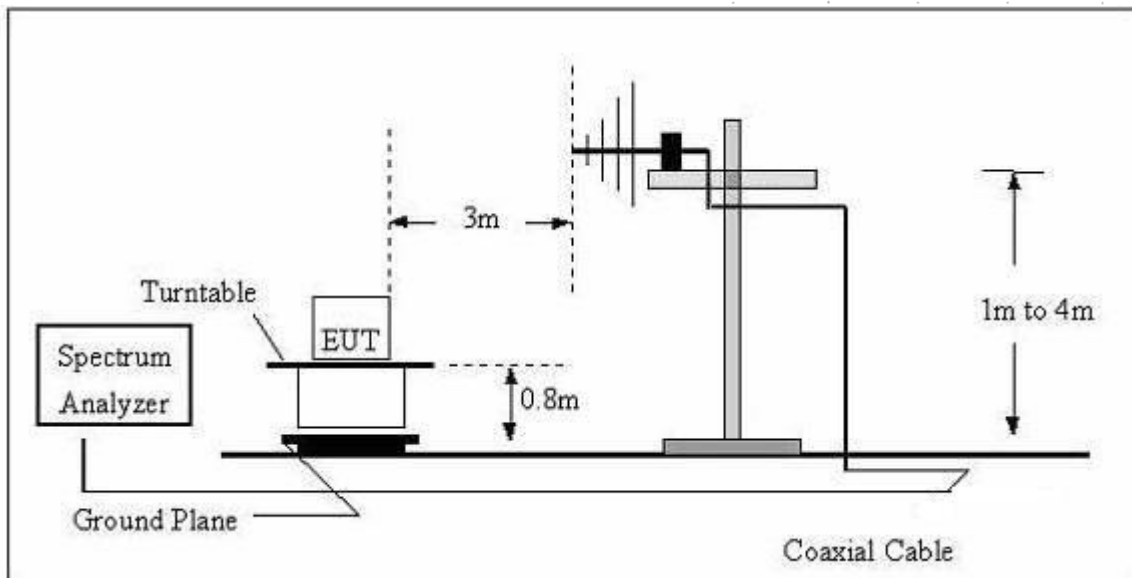

## 7.2 Limit

FCC §15.209; §15.205.

Test Standard	FCC Part15 C Section 15.209 and 15.205				
Test Limit	Frequency (MHz)	Field strength (microvolt/meter)	Limit (dBuV/m)	Remark	Measurement distance (m)
	0.009MHz~0.490MHz	2400/F(kHz)	-	-	300
	0.490MHz-1.705MHz	24000/F(kHz)	-	-	30
	1.705MHz-30MHz	30	-	-	30
	30MHz~88MHz	100	40.0	Quasi-peak	3
	88MHz~216MHz	150	43.5	Quasi-peak	3
	216MHz~960MHz	200	46.0	Quasi-peak	3
	960MHz~1000MHz	500	54.0	Quasi-peak	3
	Above 1000MHz	500	54.0	Average	3
-		74.0	Peak	3	

## 7.3 Test procedure

Receiver Parameter	Setting
Attenuation	Auto
9kHz~150kHz	RBW 200Hz for QP
150kHz~30MHz	RBW 9kHz for QP
30MHz~1000MHz	RBW 120kHz for QP

Below 1GHz test procedure as below:

- The EUT was placed on the top of a rotating table 0.8 meters above the ground at a 3 meter semi-anechoic chamber. The table was rotated 360 degrees to determine the position of the highest radiation.
- The EUT was set 3 meters away from the interference-receiving antenna, which was mounted on the top of a variable-height antenna tower.
- The antenna height is varied from one meter to four meters above the ground to determine the maximum value of the field strength. Both horizontal and vertical polarizations of the antenna are set to make the measurement.
- For each suspected emission, the EUT was arranged to its worst case and then the antenna was tuned to heights from 1 meter to 4 meters (for the test frequency of below 30MHz, the antenna was tuned to heights 1 meter) and the rotatable table was turned from 0 degrees to 360 degrees to find the maximum reading.
- The test-receiver system was set to Peak Detect Function and Specified Bandwidth with Maximum Hold Mode.
- If the emission level of the EUT in peak mode was 10dB lower than the limit specified, then testing could be stopped and the peak values of the EUT would be reported. Otherwise the emissions that did not have 10dB margin would be re-tested one by one using peak, quasi-peak or average method as specified and then reported in a data sheet.

Above 1GHz test procedure as below:

- Different between above is the test site, change from Semi- Anechoic Chamber to fully Anechoic Chamber and change form table 0.8 metre to 1.5 metre( Above 18GHz the distance is 1 meter and table is 1.5 metre).
- Test the EUT in the lowest channel ,the middle channel ,the Highest channel.

Note: Both horizontal and vertical antenna polarities were tested and performed pretest to three orthogonal axis. The worst case emissions were reported.



## 7.4 Test Result

9kHz-30MHz

Temperature:	26°C	Relative Humidity:	54%
Pressure:	101 kPa	Test Voltage:	AC 120V/60Hz
Test Mode:	Mode 1	Polarization:	Coaxial(Worst)

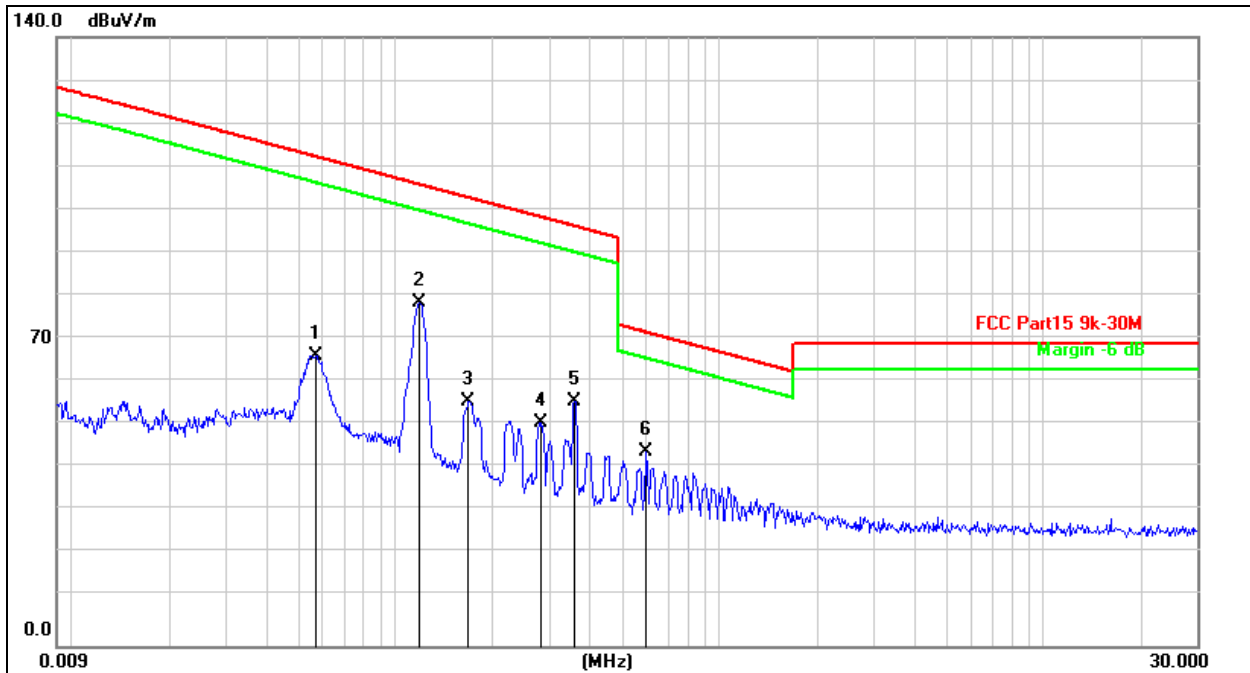

No.	Mk.	Freq. MHz	Reading Level dBuV	Correct Factor dB	Measure- ment dBuV/m	Limit dB/m	Over dB	Detector
1		0.0567	74.24	-7.42	66.82	112.5	-45.71	peak
2	*	0.1187	86.36	-7.52	78.84	106.1	-27.28	peak
3		0.1683	63.69	-7.65	56.04	103.0	-47.04	peak
4		0.2805	58.83	-7.72	51.11	98.65	-47.54	peak
5		0.3578	63.81	-7.67	56.14	96.53	-40.39	peak
6		0.5964	52.00	-7.47	44.53	72.10	-27.57	peak

Temperature:	26°C	Relative Humidity:	54%
Pressure:	101 kPa	Test Voltage:	DC 3.85V
Test Mode:	Mode 4	Polarization:	Coaxial(Worst)

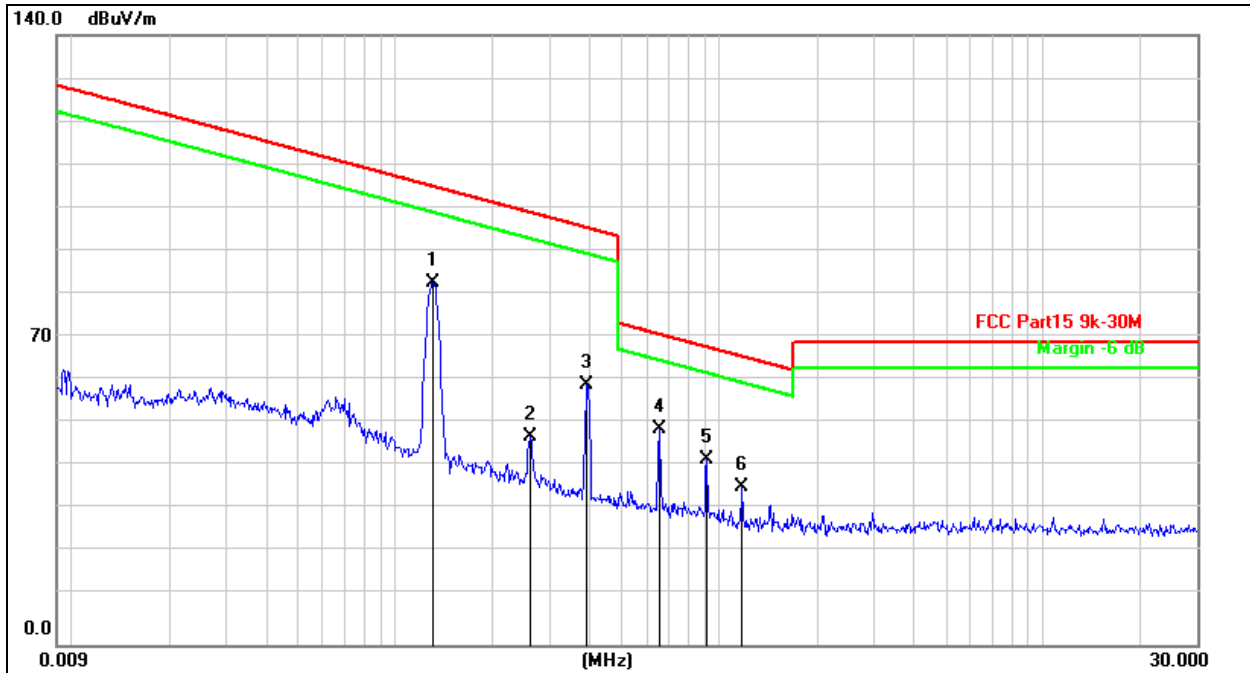

No.	Mk.	Freq. MHz	Reading Level dBuV	Correct Factor dB	Measure- ment dBuV/m	Limit dB/m	Over dB	Detector
1		0.1309	90.77	-7.55	83.22	105.2	-22.05	peak
2		0.2608	55.57	-7.74	47.83	99.28	-51.45	peak
3		0.3912	67.27	-7.65	59.62	95.76	-36.14	peak
4	*	0.6521	57.01	-7.41	49.60	71.32	-21.72	peak
5		0.9168	49.82	-7.36	42.46	68.37	-25.91	peak
6		1.1789	43.51	-7.35	36.16	66.20	-30.04	peak

CO.,LTD

Between 30MHz – 1GHz

Temperature:	26 °C	Relative Humidity:	54%
Pressure:	101KPa	Phase:	Horizontal
Test Mode:	Mode 1	Test Voltage:	AC 120V/60Hz

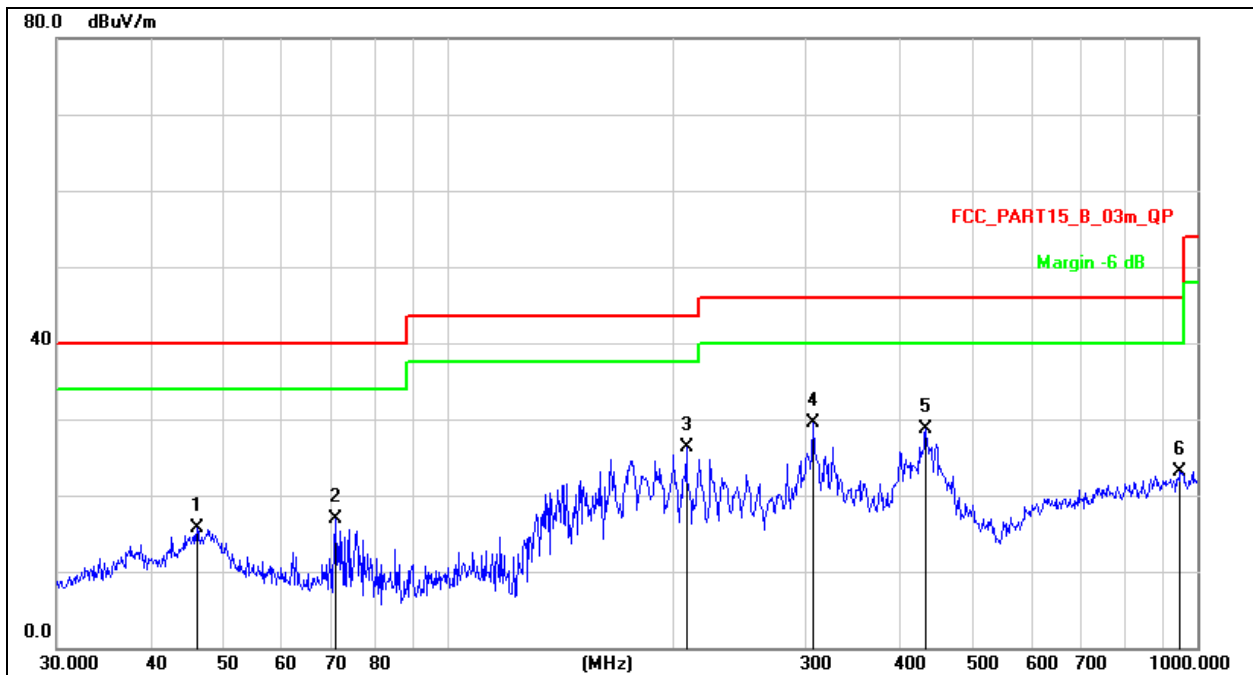

Remark:  
 1. Factor = Antenna Factor + Cable Loss – Pre-amplifier.  
 2. Measurement = Reading Level + Correct Factor  
 3. Over = Measurement - Limit

No.	Mk.	Freq. MHz	Reading Level dBuV	Correct Factor dB	Measure- ment dBuV/m	Limit dB/m	Over dB	Detector
1		46.1779	29.97	-14.21	15.76	40.00	-24.24	QP
2		70.8315	34.96	-18.15	16.81	40.00	-23.19	QP
3		207.8501	41.87	-15.50	26.37	43.50	-17.13	QP
4	*	306.7537	42.44	-13.00	29.44	46.00	-16.56	QP
5		434.0651	38.79	-10.17	28.62	46.00	-17.38	QP
6		948.7610	25.98	-2.94	23.04	46.00	-22.96	QP

SHENZHEN

Temperature:	26 °C	Relative Humidity:	54%
Pressure:	101KPa	Phase :	Vertical
Test Mode:	Mode 1	Test Voltage:	AC 120V/60Hz

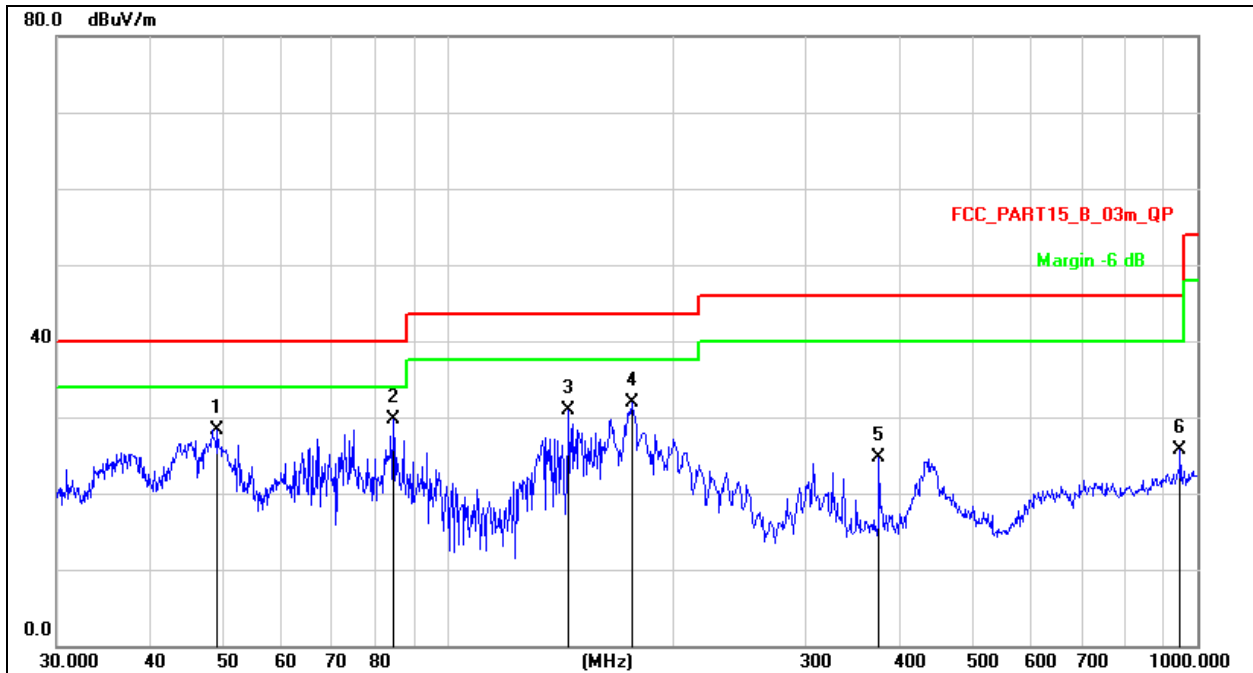
**Remark:**

1. Factor = Antenna Factor + Cable Loss – Pre-amplifier.
2. Measurement = Reading Level + Correct Factor
3. Over = Measurement - Limit

No.	Mk.	Freq.	Reading Level	Correct Factor	Measurement	Limit	Over	Detector
		MHz	dBuV	dB	dBuV/m	dB/m	dB	
1		49.1865	42.36	-13.97	28.39	40.00	-11.61	QP
2	*	84.4054	48.50	-18.71	29.79	40.00	-10.21	QP
3		144.8418	50.02	-19.07	30.95	43.50	-12.55	QP
4		175.6516	49.51	-17.53	31.98	43.50	-11.52	QP
5		375.9385	35.81	-11.15	24.66	46.00	-21.34	QP
6		948.7610	28.69	-2.94	25.75	46.00	-20.25	QP

Temperature:	26 °C	Relative Humidity:	54%
Pressure:	101KPa	Phase :	Horizontal
Test Mode:	Mode 4	Test Voltage:	DC 3.7V

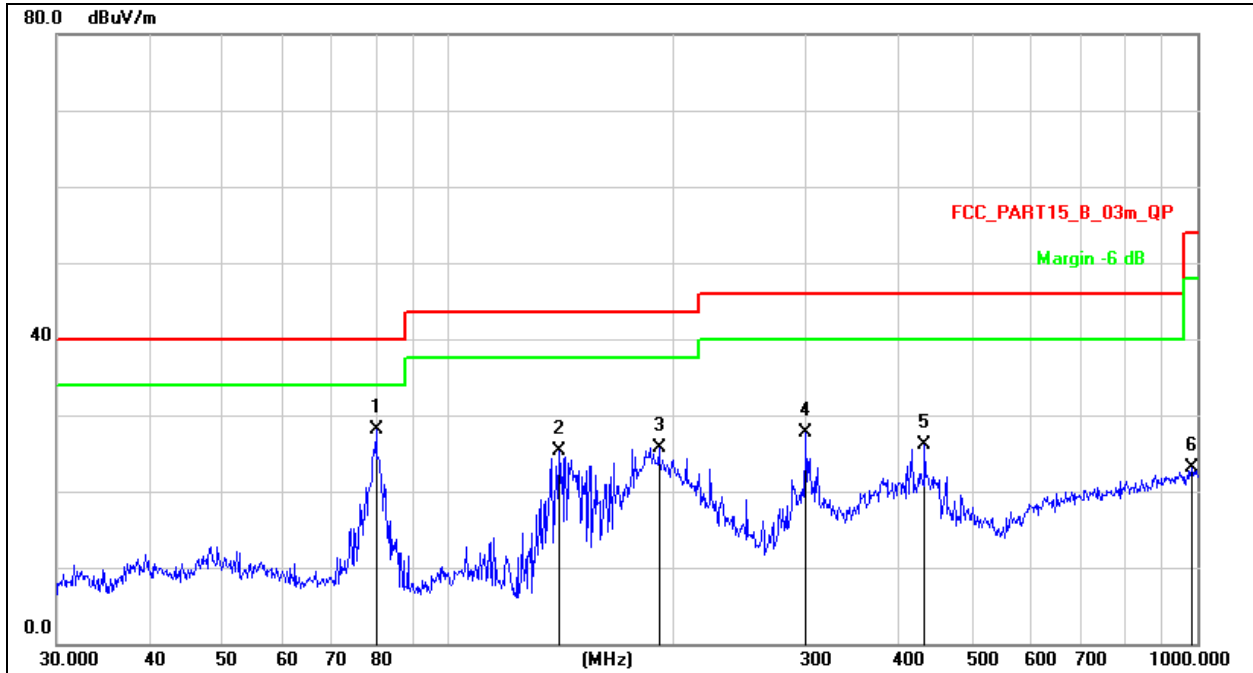
**Remark:**

1. Factor = Antenna Factor + Cable Loss – Pre-amplifier.
2. Measurement = Reading Level + Correct Factor
3. Over = Measurement - Limit

No.	Mk.	Freq.	Reading Level	Correct Factor	Measurement	Limit	Over	Detector
		MHz	dBuV	dB	dBuV/m	dB/m	dB	
1	*	80.0806	47.78	-19.73	28.05	40.00	-11.95	QP
2		140.8351	44.03	-18.79	25.24	43.50	-18.26	QP
3		191.0738	42.05	-16.38	25.67	43.50	-17.83	QP
4		300.3672	41.01	-13.23	27.78	46.00	-18.22	QP
5		432.5457	36.36	-10.20	26.16	46.00	-19.84	QP
6		982.6200	25.61	-2.56	23.05	54.00	-30.95	QP

Temperature:	26 °C	Relative Humidity:	54%
Pressure:	101KPa	Phase :	Vertical
Test Mode:	Mode 4	Test Voltage:	DC 3.7V

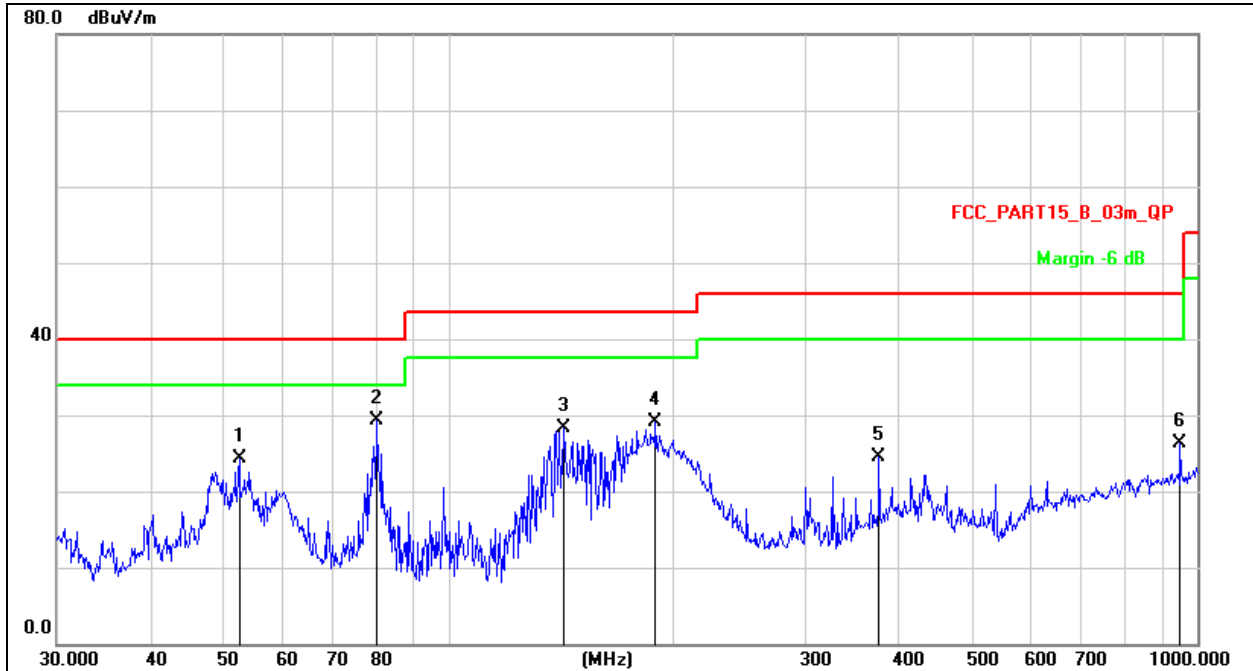
**Remark:**

1. Factor = Antenna Factor + Cable Loss – Pre-amplifier.
2. Measurement = Reading Level + Correct Factor
3. Over = Measurement - Limit

No.	Mk.	Freq.	Reading Level	Correct Factor	Measurement	Limit	Over	Detector
		MHz	dBuV	dB	dBuV/m	dB/m	dB	
1		52.5753	38.61	-14.25	24.36	40.00	-15.64	QP
2	*	80.3619	48.89	-19.66	29.23	40.00	-10.77	QP
3		142.8243	47.17	-18.93	28.24	43.50	-15.26	QP
4		189.0743	45.57	-16.53	29.04	43.50	-14.46	QP
5		375.9385	35.67	-11.15	24.52	46.00	-21.48	QP
6		948.7610	29.32	-2.94	26.38	46.00	-19.62	QP

## 8. Bandwidth Test

### 8.1 Test Procedure

1. Set RBW = 1%~5% OBW.
2. Set the video bandwidth (VBW)  $\geq 3 \times$  RBW.
3. Detector = Peak.
4. Trace mode = max hold.
5. Sweep = auto couple.
6. Allow the trace to stabilize.
7. Measure the maximum width of the emission that is constrained by the frequencies associated with the two outermost amplitude points (upper and lower frequencies) that are attenuated by 20 dB relative to the maximum level measured in the fundamental emission.

### 8.2 Test Setup



### 8.3 Test Result

Frequency (kHz)	20dB bandwidth (kHz)	Result
127.3	0.095	Pass

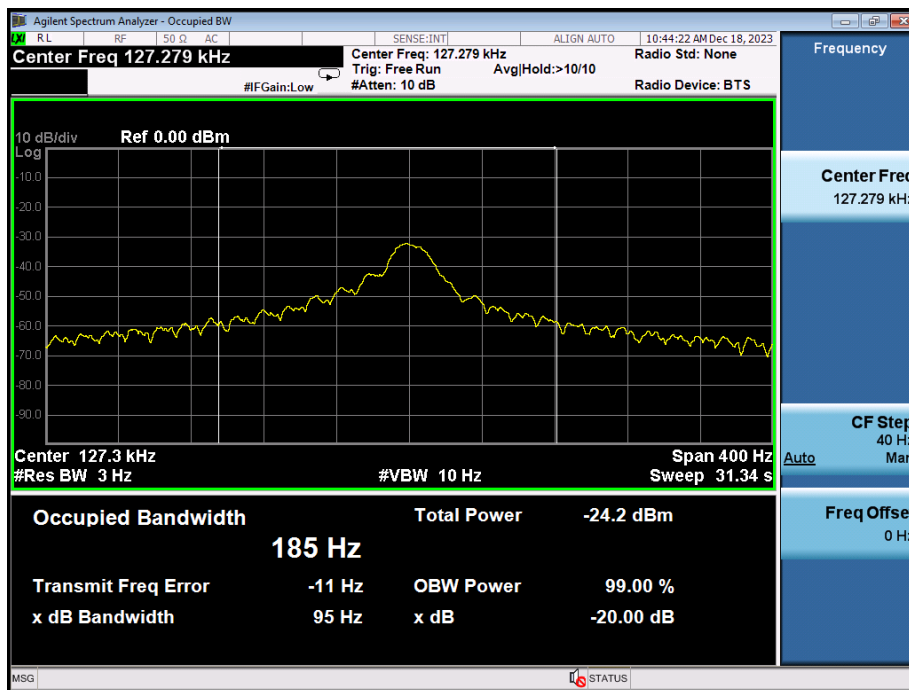

## 9. Antenna Requirements

### 9.1 Limit

For intentional device, according to FCC 47 CFR Section 15.203, An intentional radiator shall be designed to ensure that no antenna other than that furnished by the responsible party shall be used with the device. The use of a permanently attached antenna or of an antenna that uses a unique coupling to the intentional radiator shall be considered sufficient to comply with the provisions of this section. The manufacturer may design the unit so that a broken antenna can be replaced by the user, but the use of a standard antenna jack or electrical connector is prohibited.

### 9.2 Test Result

The antenna used for this product is Inductive coil antenna.

CO., LTD



**10. EUT Photographs**

EUT Photo 1

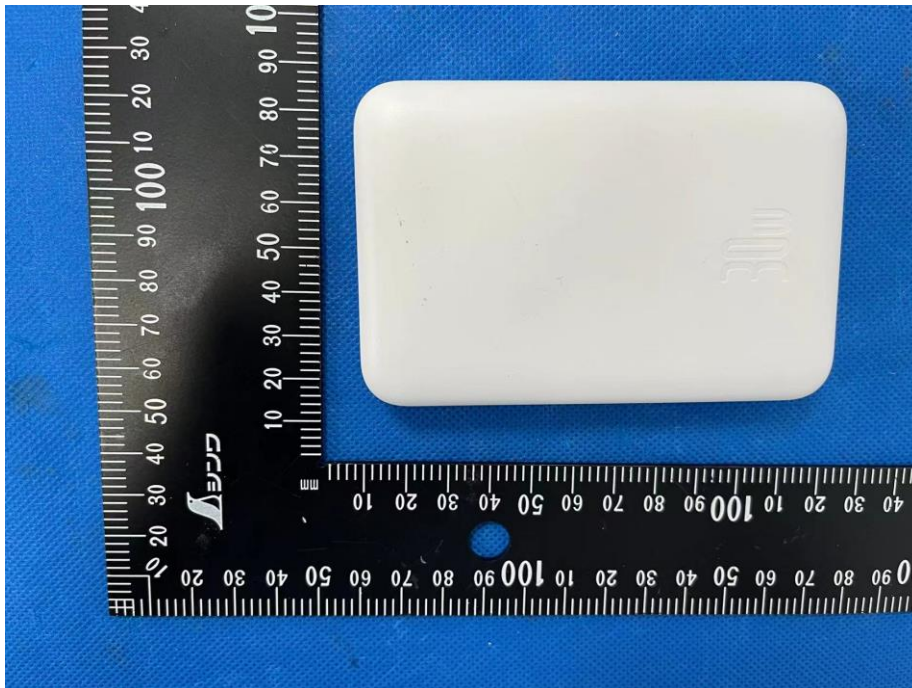
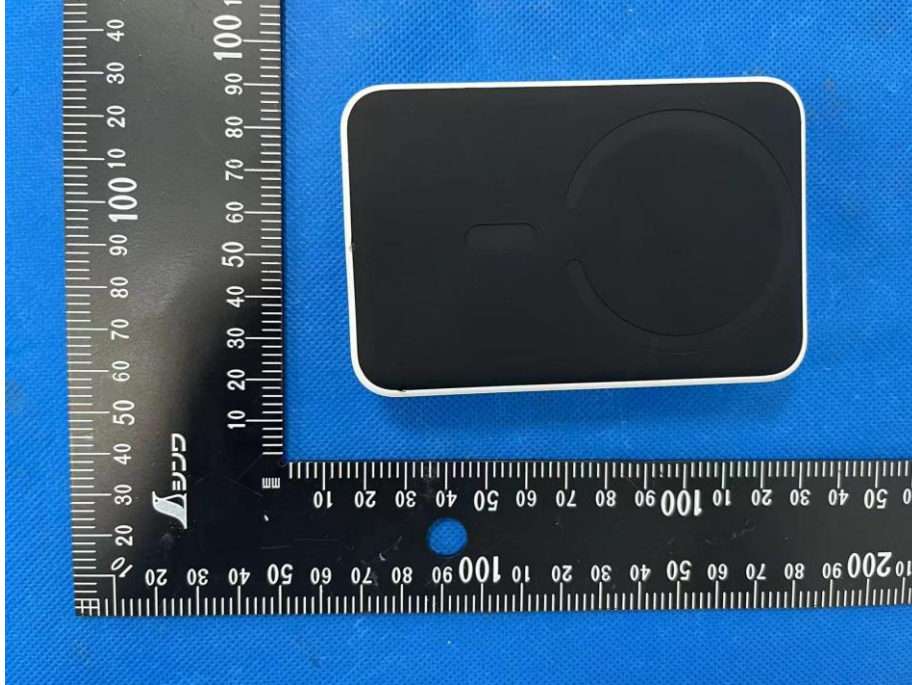

NOTE: Appendix-Photographs Of EUT Constructional Details



### 11. EUT Test Setup Photographs

Conducted emissions

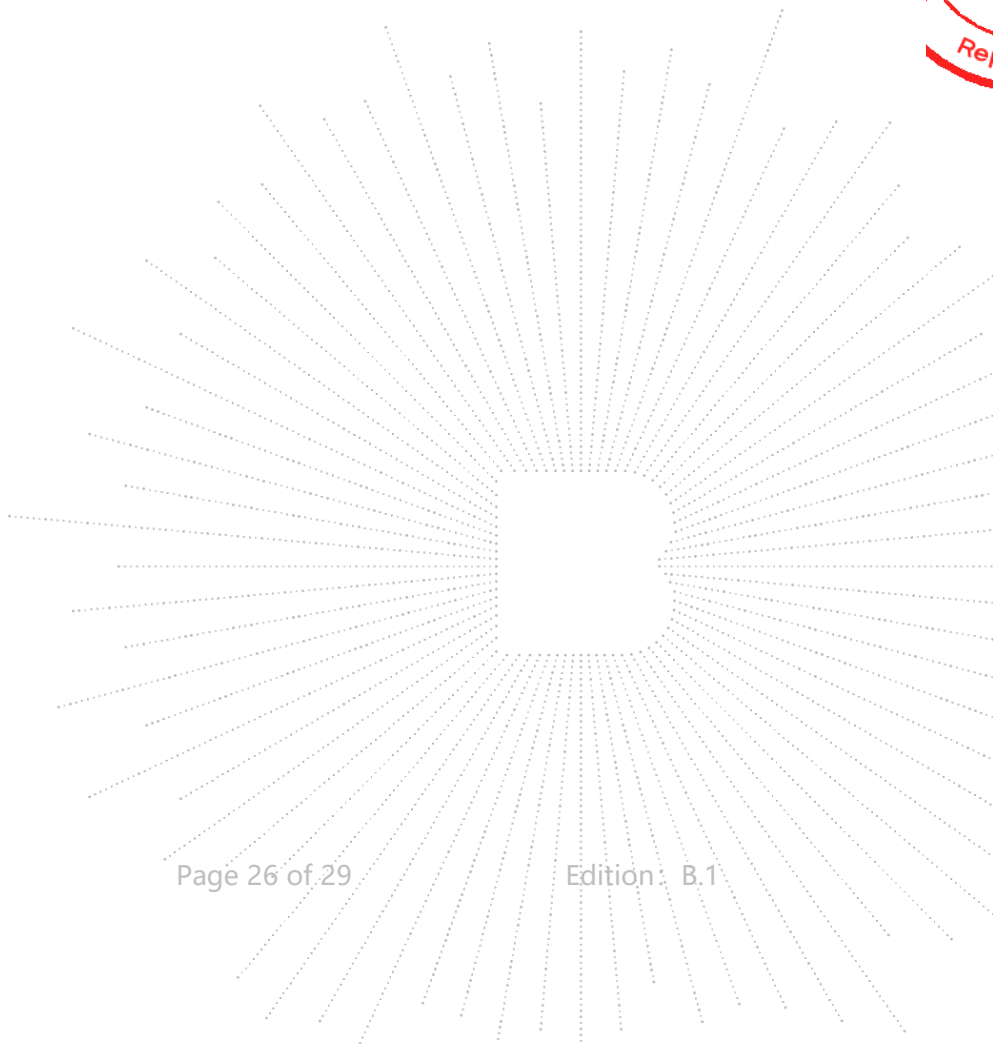

Radiated Measurement Photos  
30MHz-1GHz

Mode 1-3

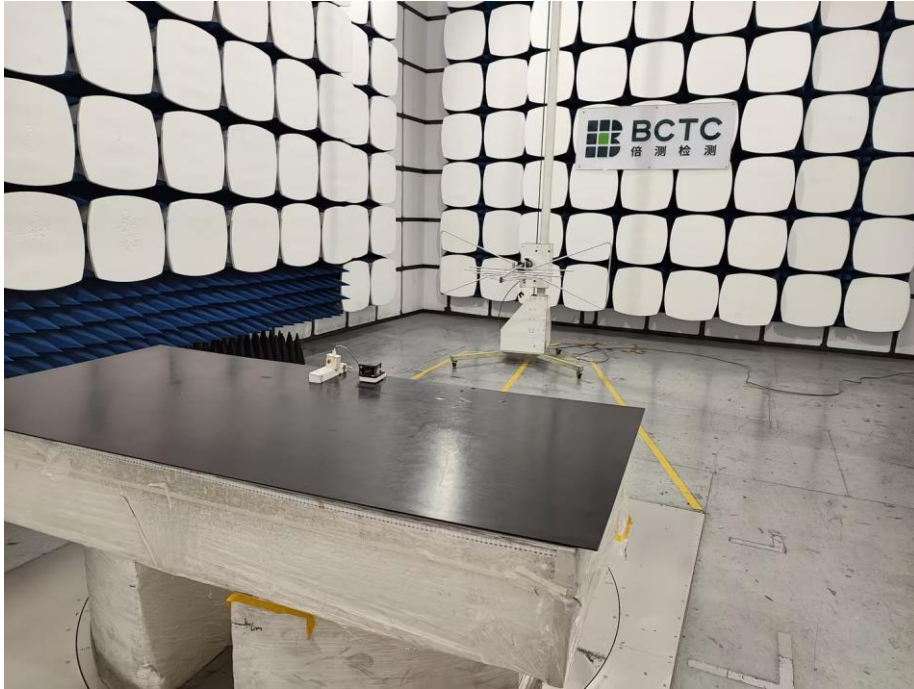

Mode 4-6



C T  
CT  
PRO  
port S

9kHz-30MHz

Mode 1-3



Mode 4-6



**STATEMENT**

1. The equipment lists are traceable to the national reference standards.
2. The test report can not be partially copied unless prior written approval is issued from our lab.
3. The test report is invalid without the "special seal for inspection and testing".
4. The test report is invalid without the signature of the approver.
5. The test process and test result is only related to the Unit Under Test.
6. Sample information is provided by the client and the laboratory is not responsible for its authenticity.
7. The quality system of our laboratory is in accordance with ISO/IEC17025.
8. If there is any objection to this test report, the client should inform issuing laboratory within 15 days from the date of receiving test report.

**Address:**

1-2/F., Building B, Pengzhou Industrial Park, No.158, Fuyuan 1st Road, Zhancheng, Fuhai Subdistrict, Bao'an District, Shenzhen, Guangdong, China

TEL: 400-788-9558

P.C.: 518103

FAX: 0755-33229357

Website: <http://www.chnbctc.com>E-Mail: [bctc@bctc-lab.com.cn](mailto:bctc@bctc-lab.com.cn)

\*\*\*\*\* END \*\*\*\*\*