

俯视图

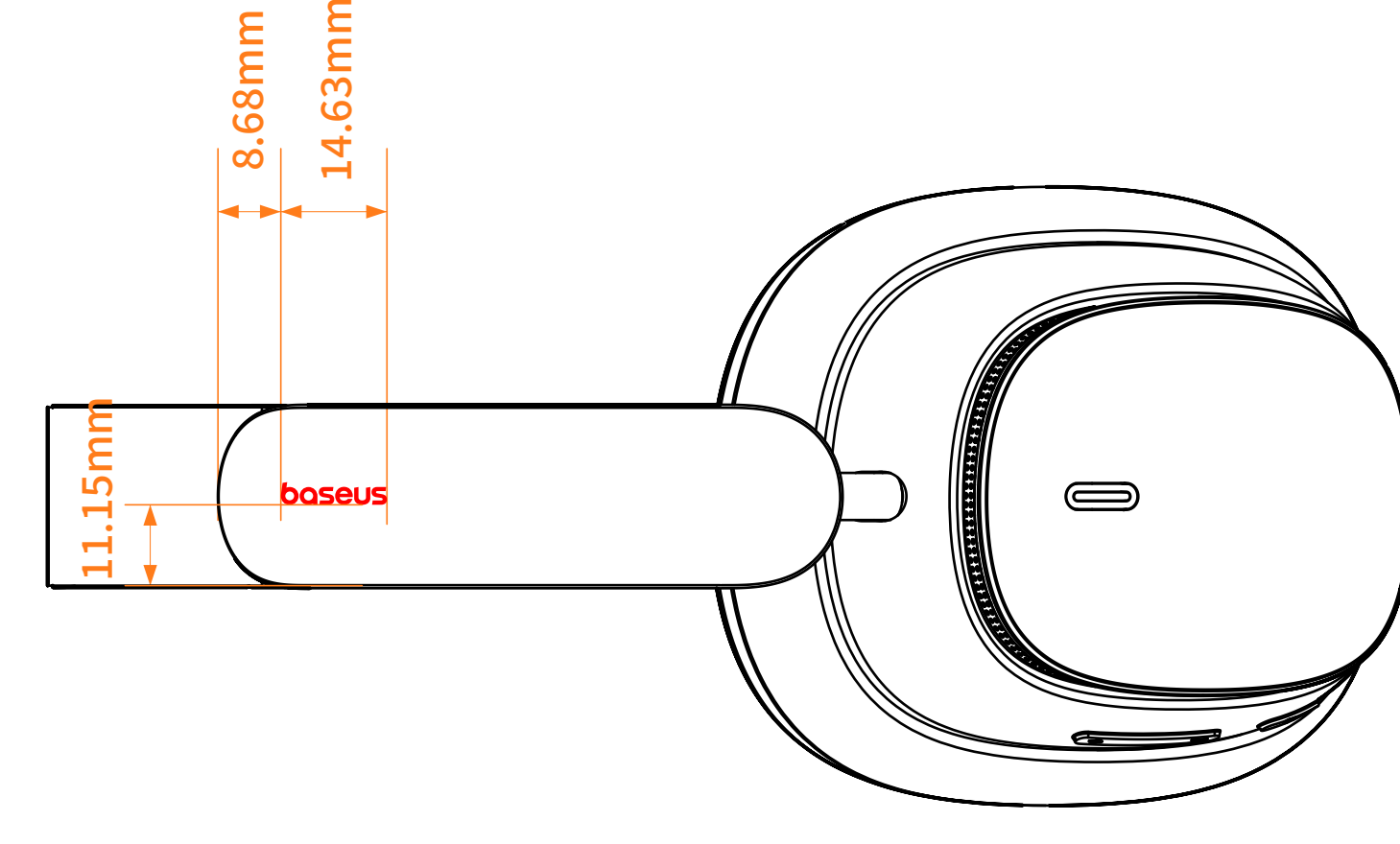

左视图

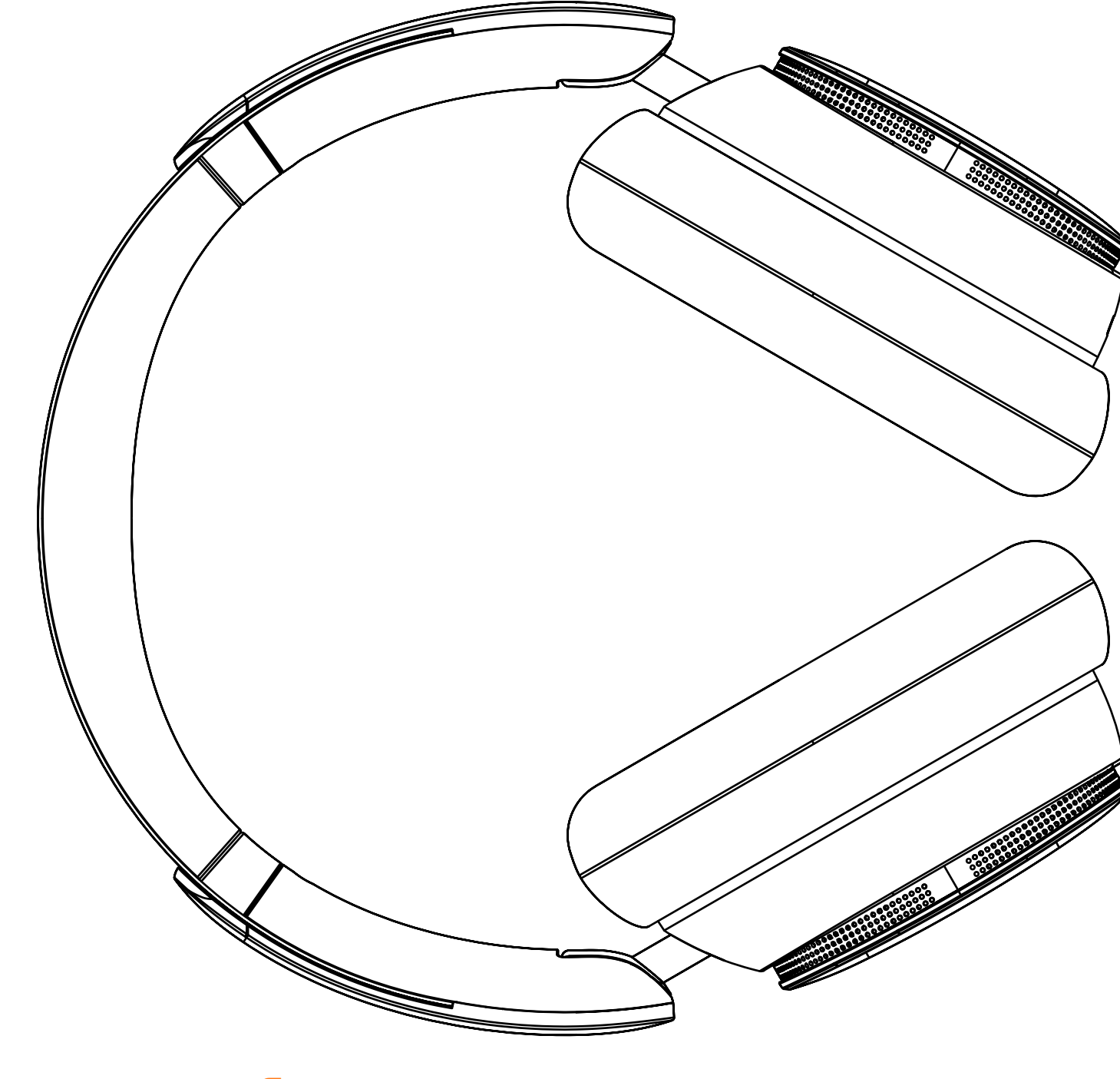

前视图

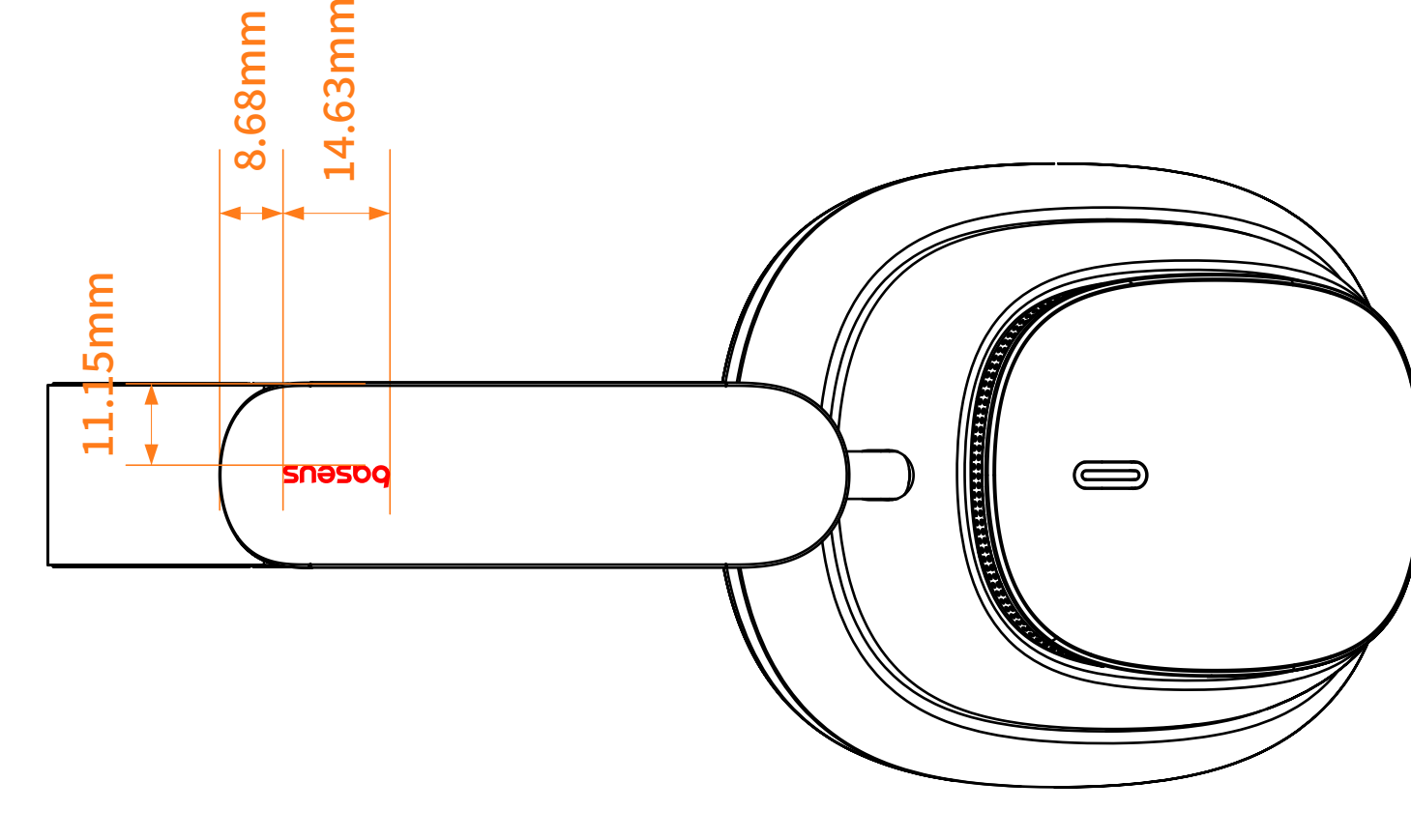

右视图

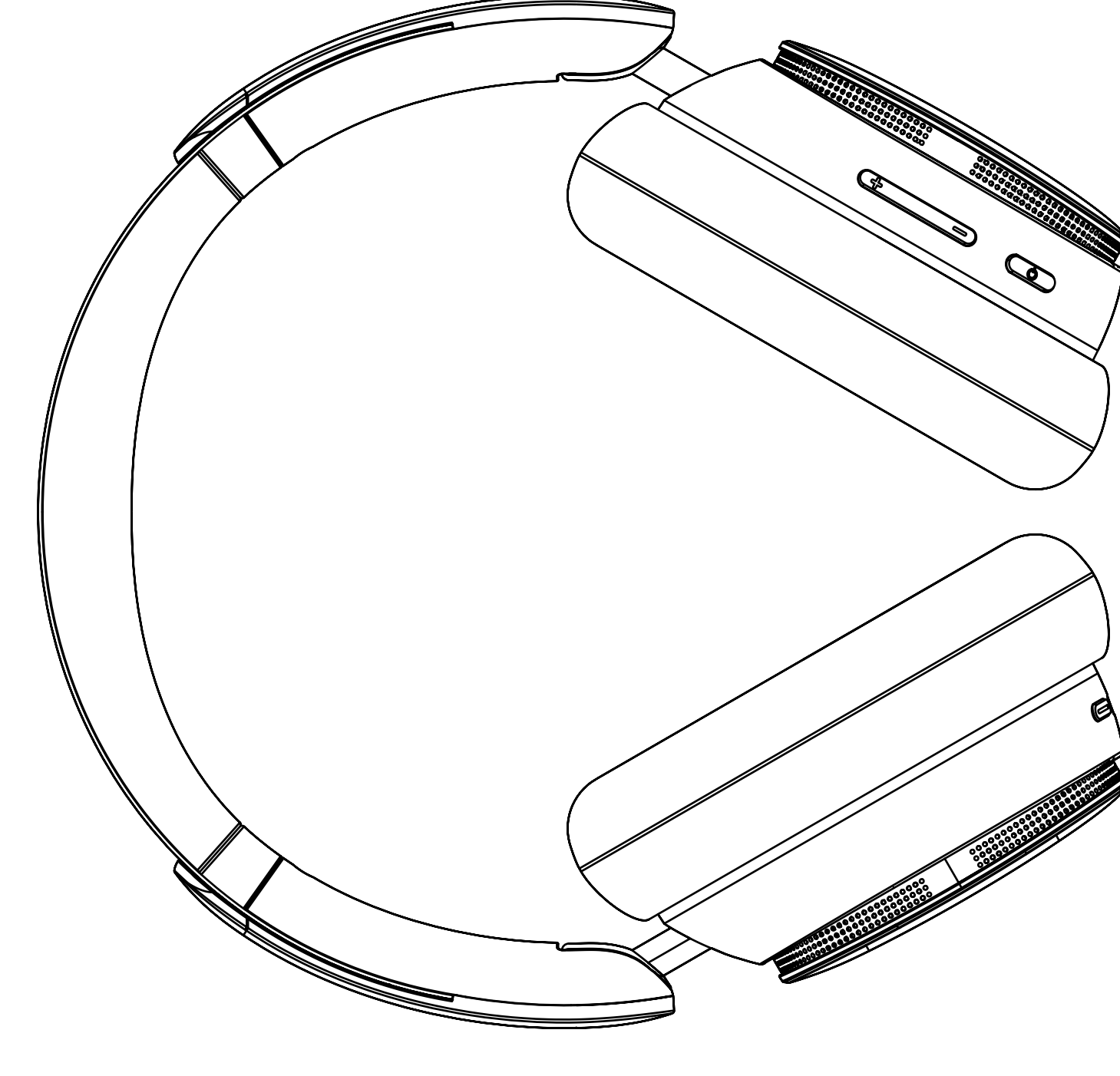

背视图

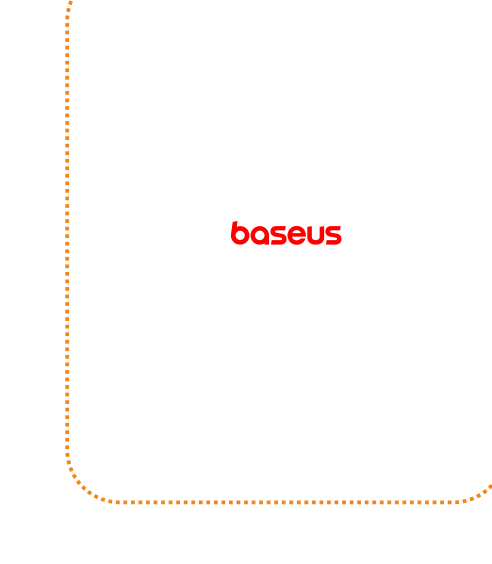

1. 左边LOGO
工艺：丝印
颜色：星曜黑；亮UV
晒月白：PANTONE Cool Gray 3C

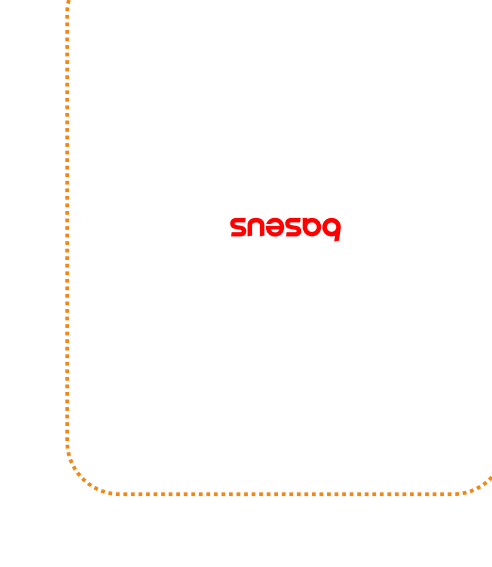

2. 右边LOGO
工艺：丝印
颜色：星曜黑；亮UV
晒月白：PANTONE Cool Gray 3C

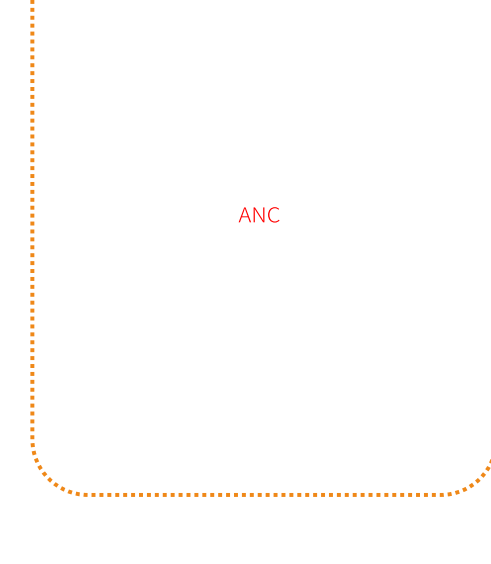

3. 按键标识
工艺：镭雕

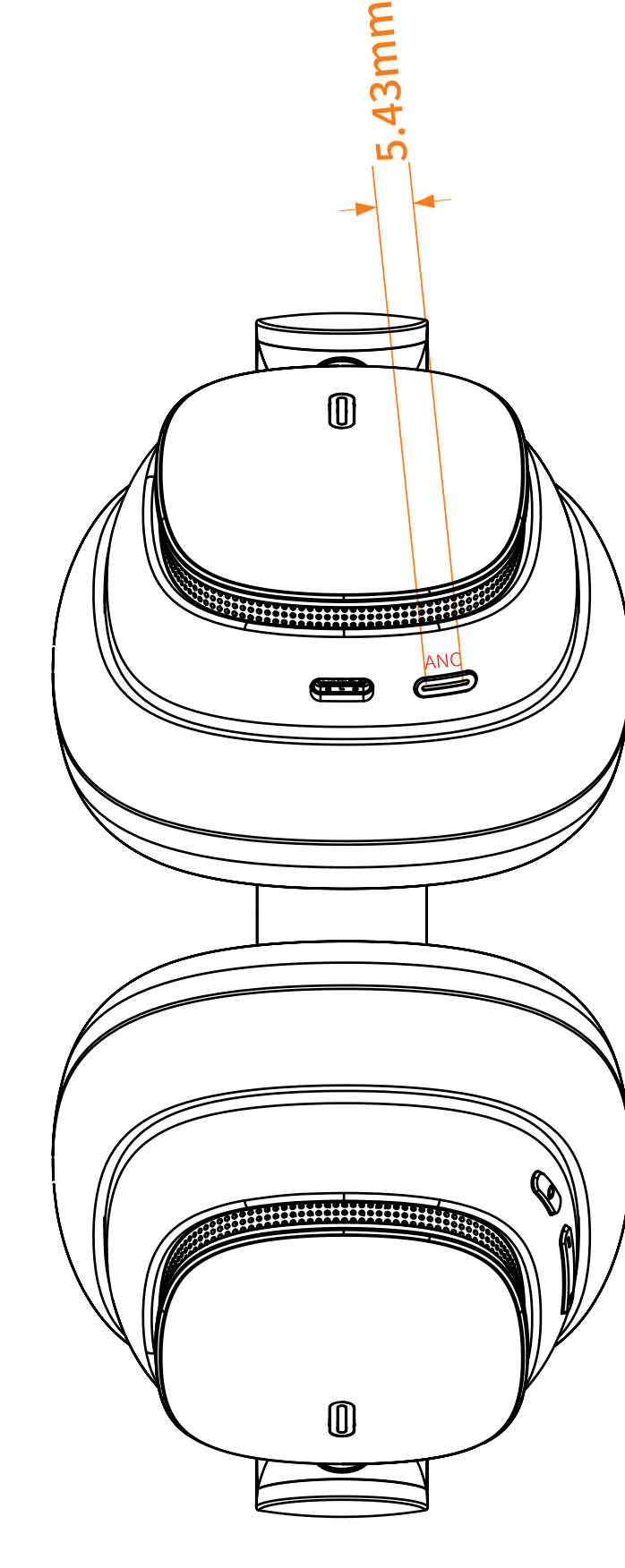

仰视图

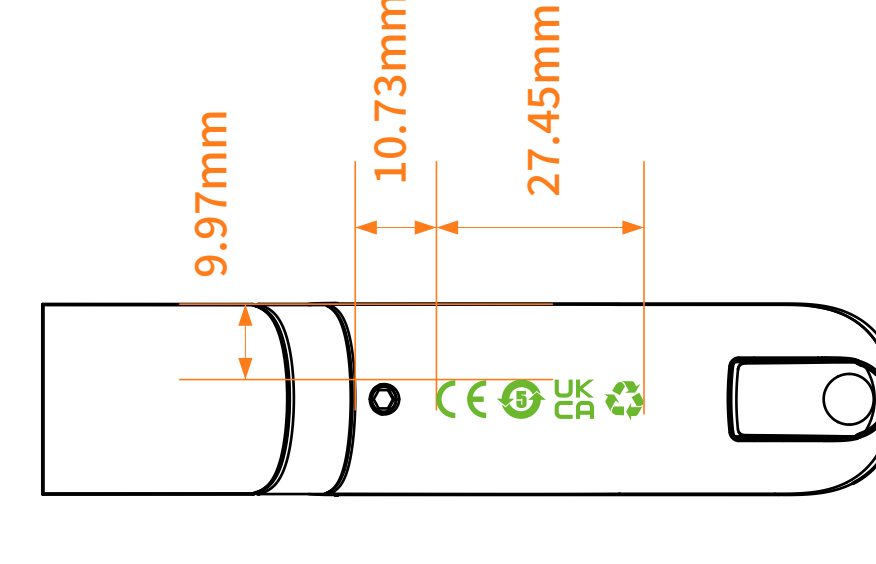

左头梁伸缩处

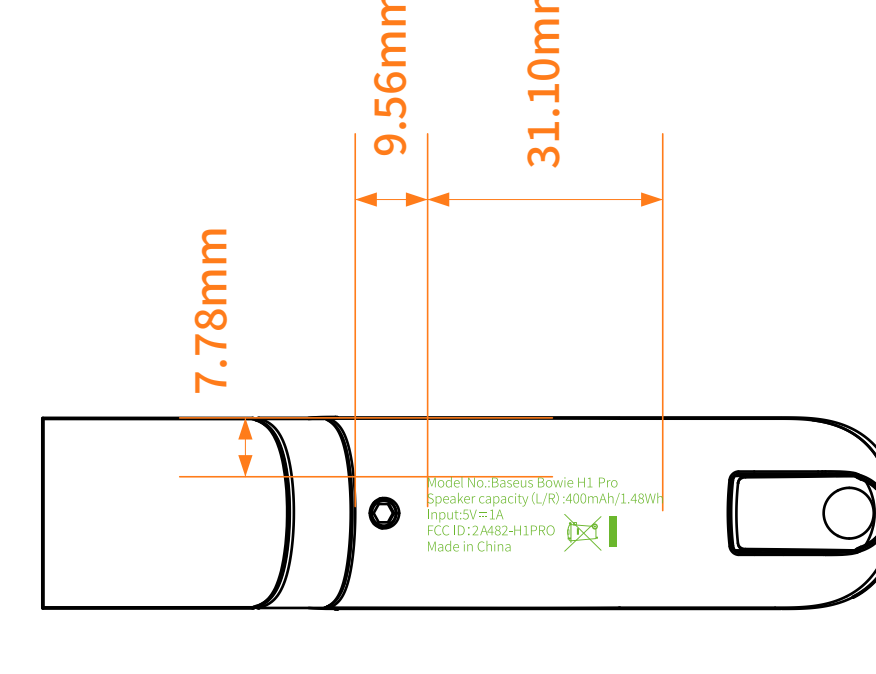

右头梁伸缩处

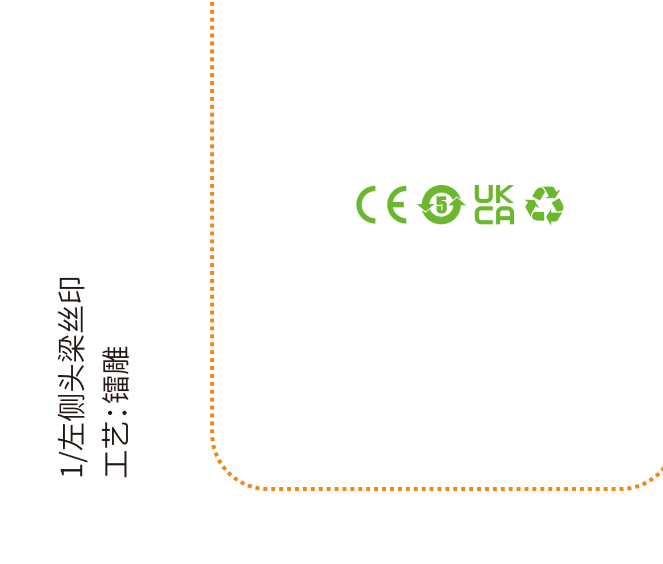

1/2 左侧头梁丝印
工艺：镭雕

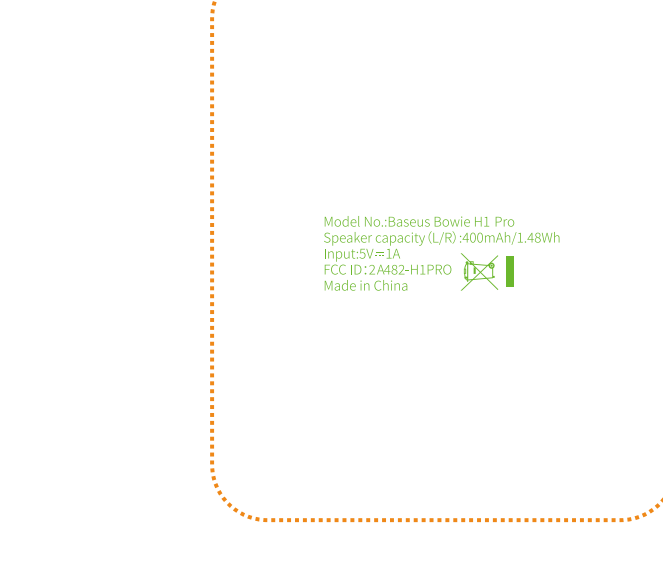

5. 右头梁丝印
工艺：镭雕

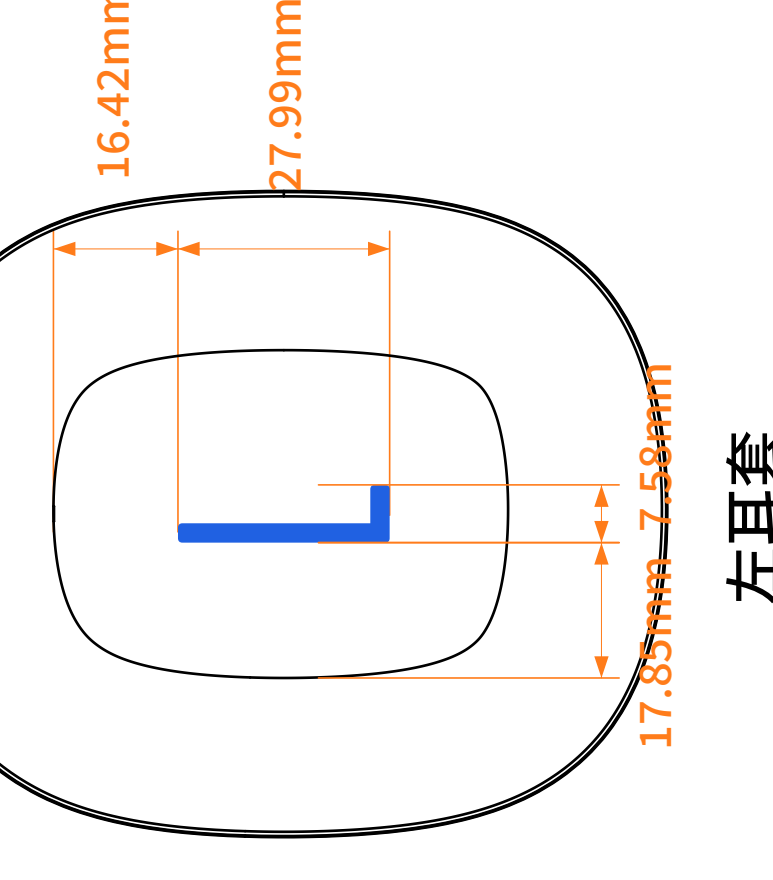

左耳套

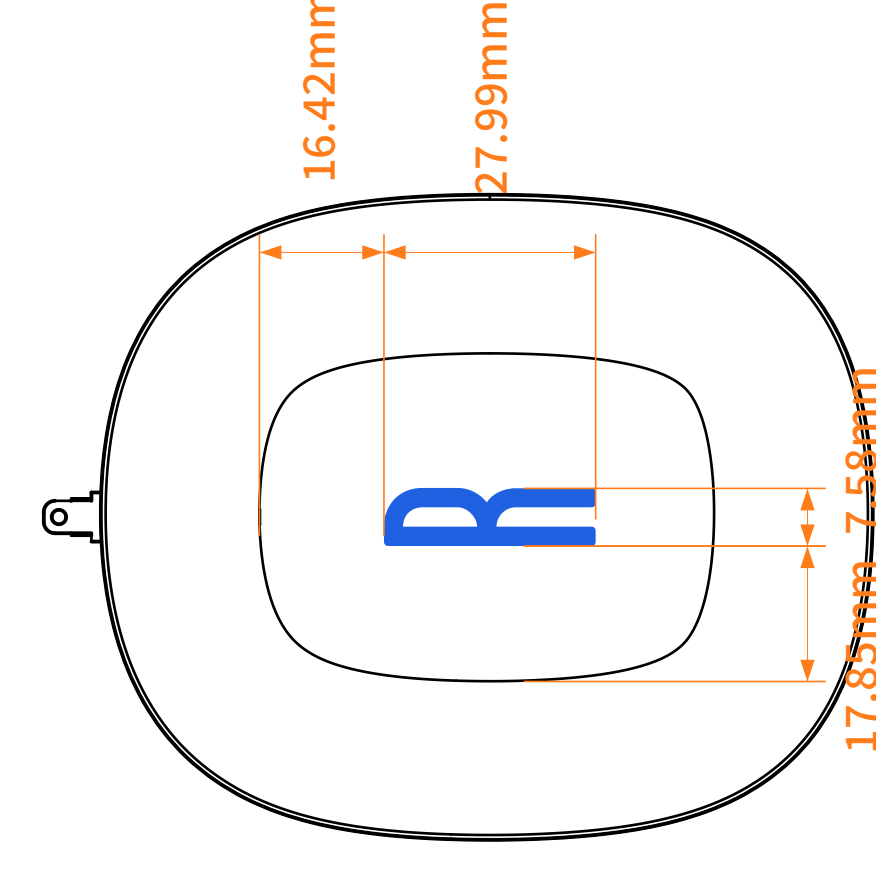

右耳套

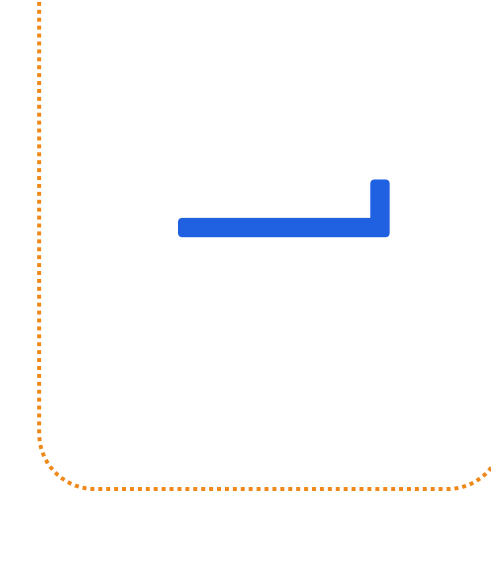

4. 左头梁标识
工艺：丝印
颜色：星曜黑；PANTONE BLACK
晒月白：PANTONE Cool Gray 3C

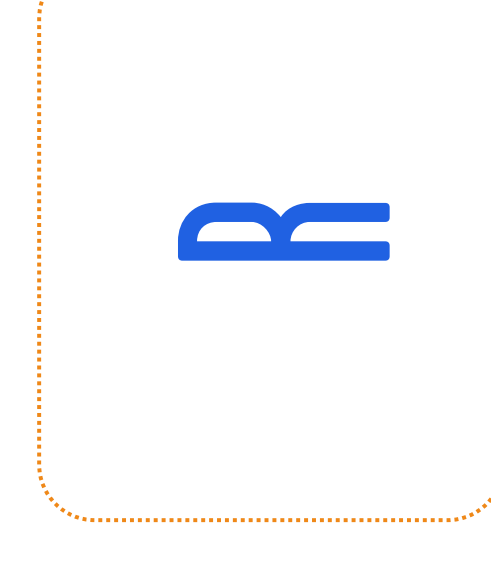

5. 右头梁标识
工艺：丝印
颜色：星曜黑；PANTONE BLACK
晒月白：PANTONE Cool Gray 3C

注释说明

修改内容

更改了参数信息

设计制图

设计审核

CMF审核

杜仲航