

# Antenna Specification

Dongguan Huaxing Fast Electronic Co., LTD

## Specifications

### Summary

ITEM	SPEC.	
Antenna Type	PCB Antenna	
Center Frequency	2402 MHz	2.34 dBi
	2441 MHz	2.07dBi
	2480 MHz	1.45 dBi
MAX. GAIN	2.34 dBi	
Polarization	Horizontal	
Azimuth Beam Pattern	Omni-directional	
Impedance	50 $\Omega$	
Antenna Length	3.1cm	

Antenna Photo & Length (mm)

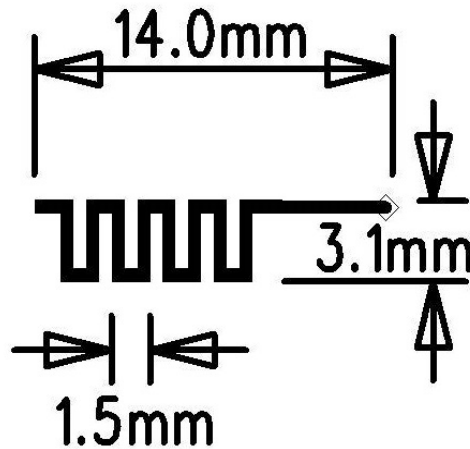

Test Address	16 Tzu Chiang Road, Hsinchu Industrial District Hsinchu Hsien 303, Taiwan
Test Date	2009-04-14
Test Instrument	vector network analyzer - R&S ZVB20

# 1. Main antenna : 2402 MHz

## 1.1 Horizontal

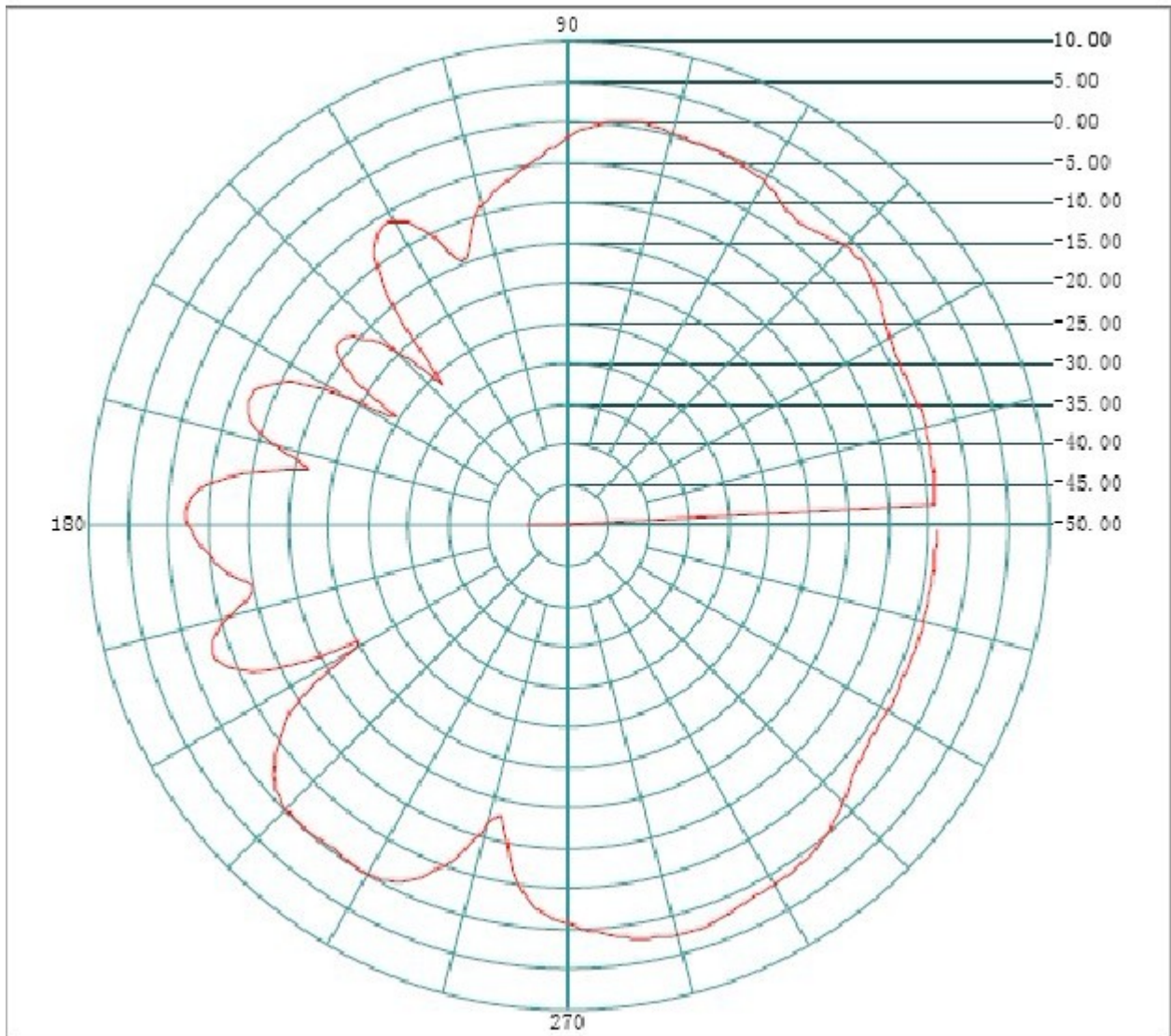

Frequency(MHZ): **2402**

Antenna Polarity: **Horizontal**

Maximum Value(dBi): **2.34**

Average Gain(dBi) : **-2.48**

Minimum Gain(dBi): **-55.18**

## 1.2 Vertical

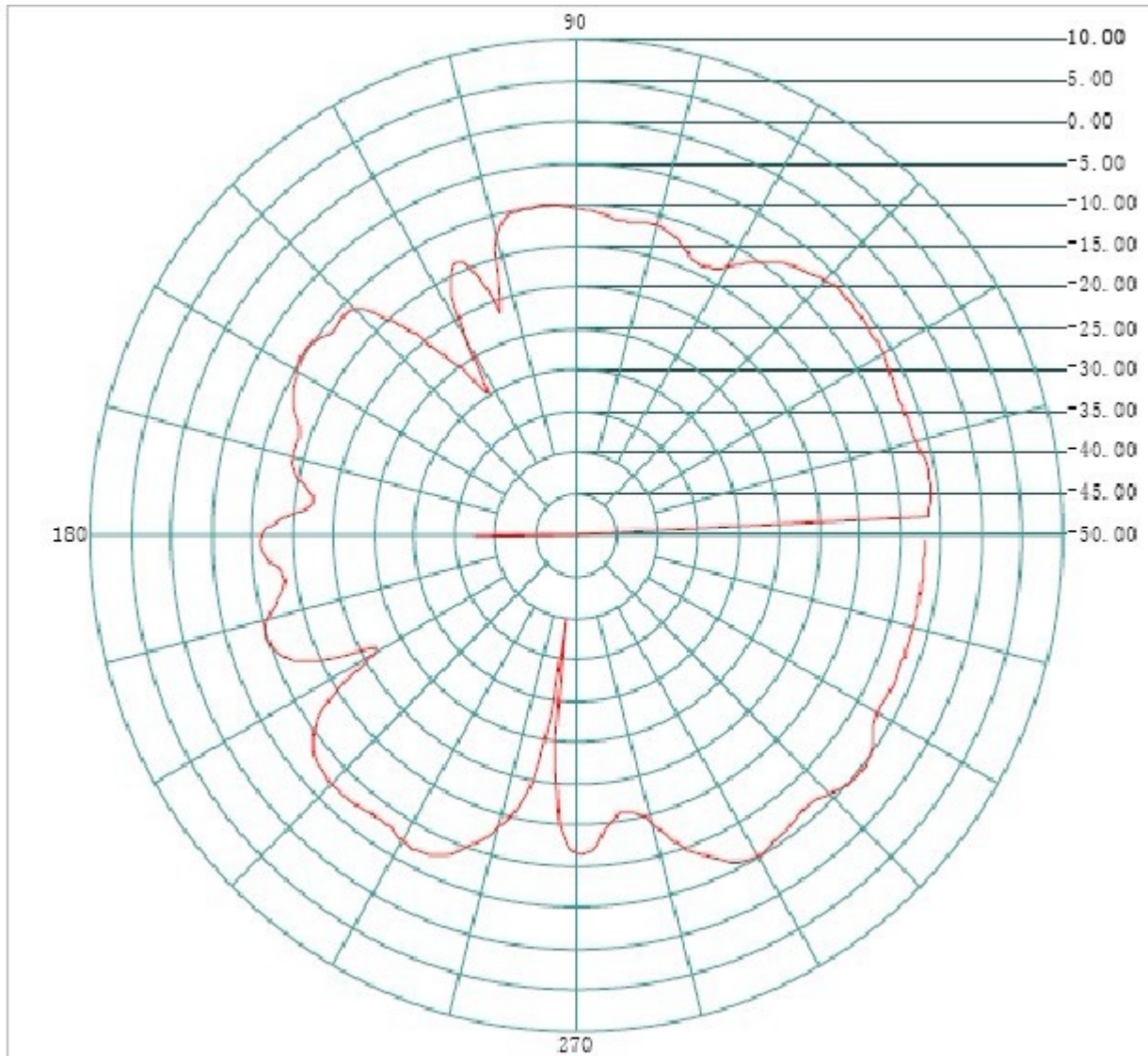

Frequency(MHZ): **2402**

Antenna Polarity: **Vertical**

Maximum Value(dBi): **-4.51**

Average Gain(dBi) : **-8.98**

Minimum Gain(dBi): **-62.3**

## 2. Main antenna : 2441 MHz

### 2.1 Horizontal

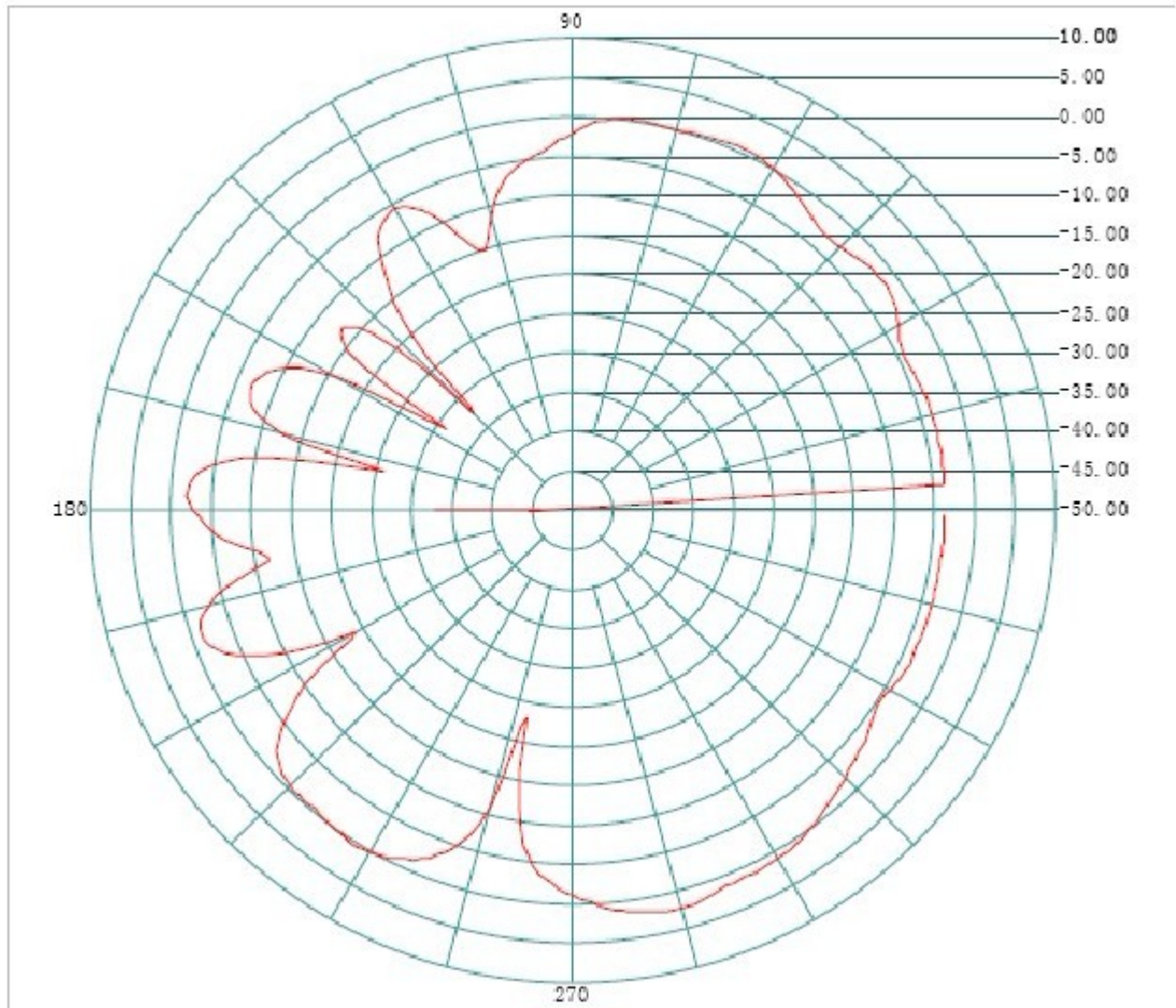

Frequency(MHZ): **2441**

Antenna Polarity: **Horizontal**

Maximum Value(dBi): **2.07**

Average Gain(dBi) : **-2.54**

Minimum Gain(dBi): **-66.98**

## 2.2 Vertical

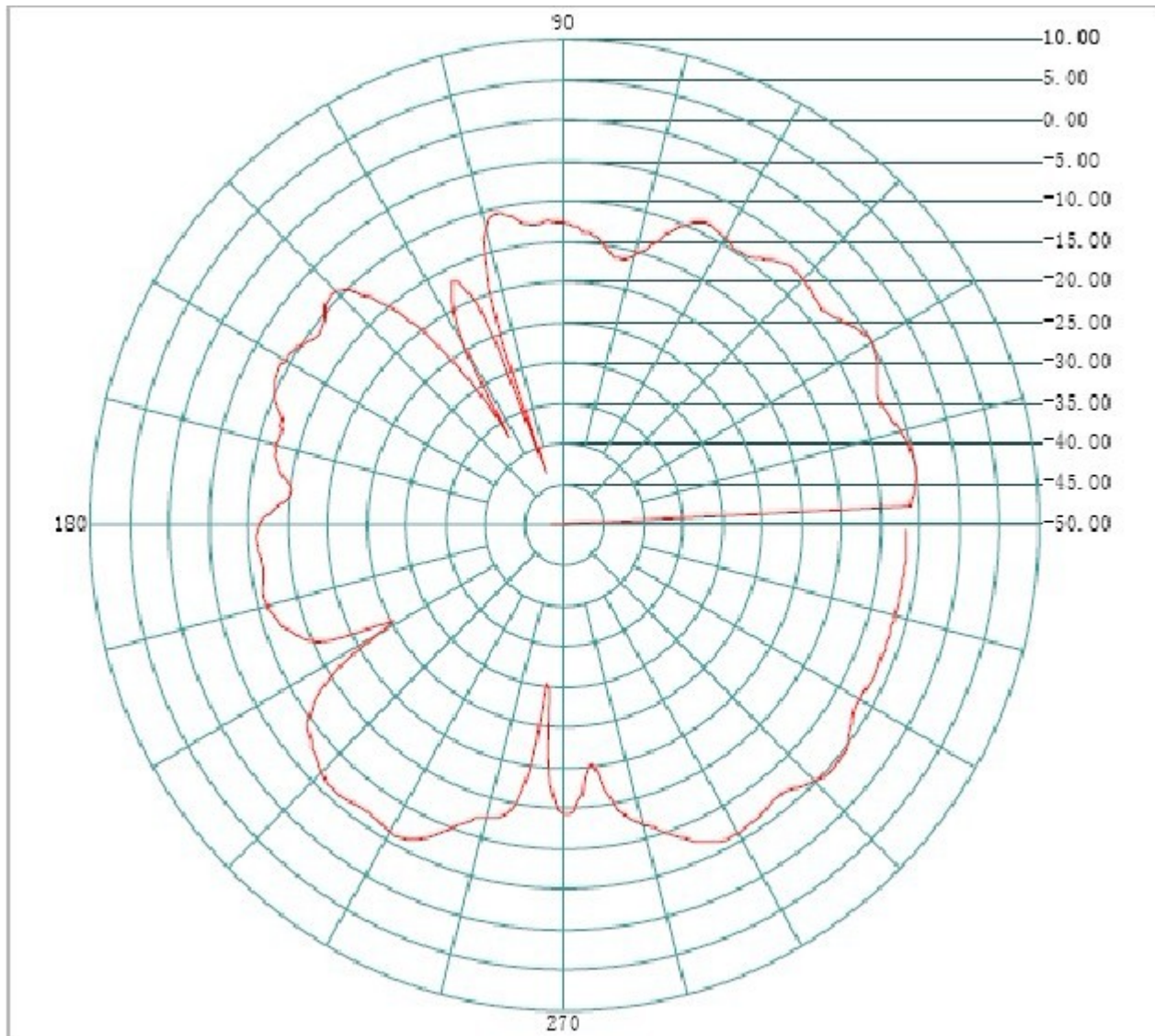

Frequency(MHZ): **2441**

Antenna Polarity: **Vertical**

Maximum Value(dBi): **-4.29**

Average Gain(dBi) : **-8.81**

Minimum Gain(dBi): **-51.4**

## 2. Main antenna : 2480 MHz

### 2.1 Horizontal

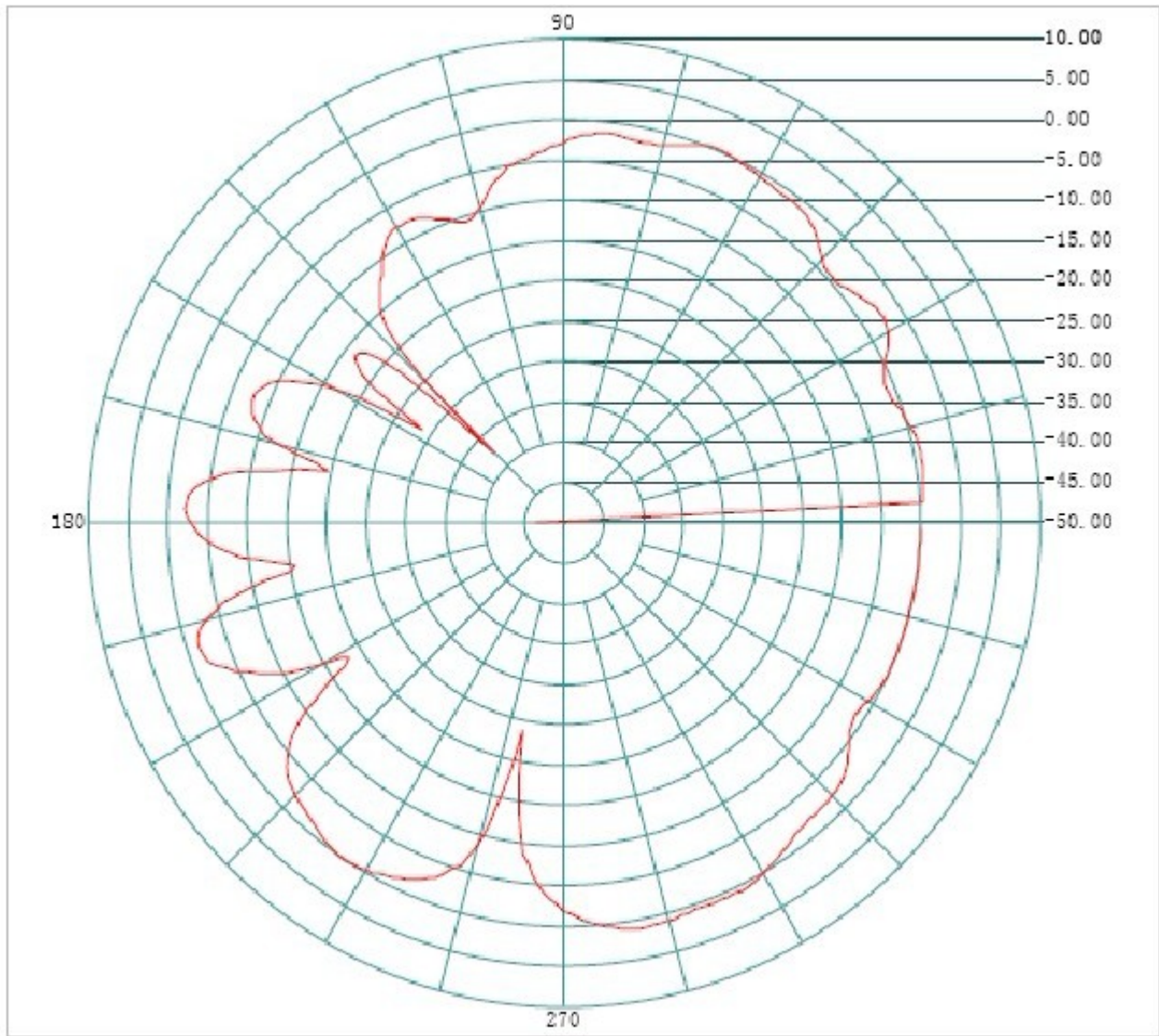

Frequency(MHZ): **2480**

Antenna Polarity: **Horizontal**

Maximum Value(dBi): **1.45**

Average Gain(dBi) : **-3.34**

Minimum Gain(dBi): **-53.4**

## 2.2 Vertical

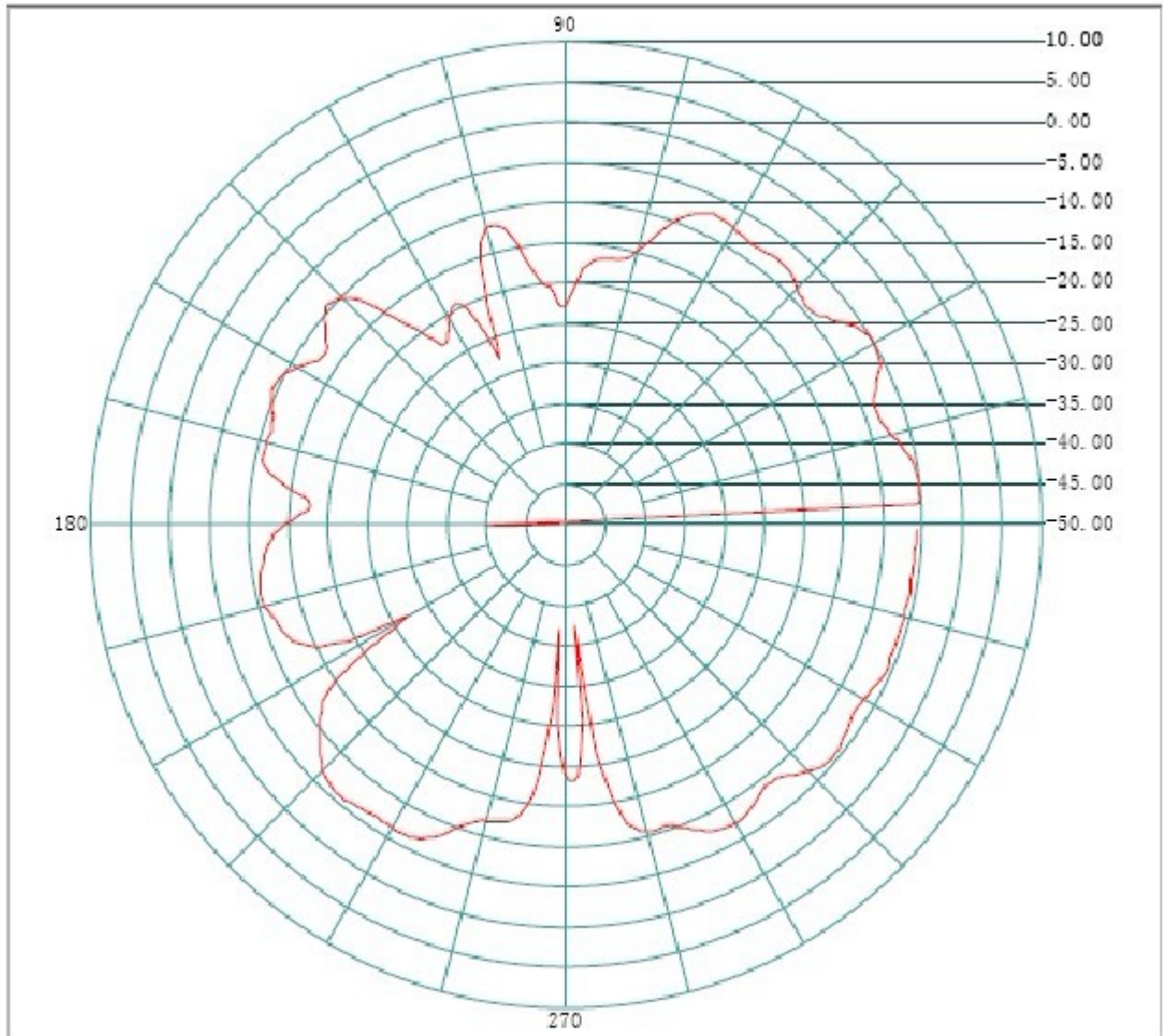

Frequency(MHZ): **2480**

Antenna Polarity: **Vertical**

Maximum Value(dBi): **-4.95**

Average Gain(dBi) : **-9.06**

Minimum Gain(dBi): **-60.00**