

2.4GHz 3216 Chip Antenna: ANT3216R24003KL0

Application:

WLAN, 802.11b/g, Bluetooth, etc...

Features

SMD, high reliability, ultra compact, Omni-directional...

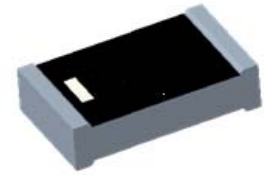

Part number

ANT 3216 R 2400 3K L0
(1) (2) (3) (4) (5)

(1)Size Code	3.2x1.6mm
(2) Packing	Tape and reel
(3) Frequency	2.4GHz
(4) Packing Number	3K
(5)Code	L0

Electrical Specification

Working FrequencyRange	2400 ~2484 MHz
Peak Gain	1.08dBi (Typ.)
Impedance	50 Ohm
VSWR	2.5(Max)
Polarization	Linear
Azimuth Beamwidth	Omni-directional
Operation Temperature(°C)	-40~85°C

The specification is defined on HEK EVB.

Dimension and Terminal Configuration

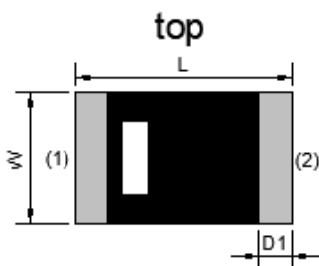

Dimension (mm)	
L	3.20±0.15
W	1.60±0.15
T	0.60±0.10
D1	0.50±0.15
D2	1.30±0.15

No.	Terminal Name
1	Feeding
2	Ground

btm

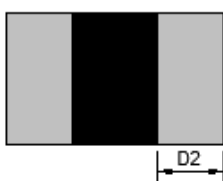

Evaluation Board Reference

PCB Dimension

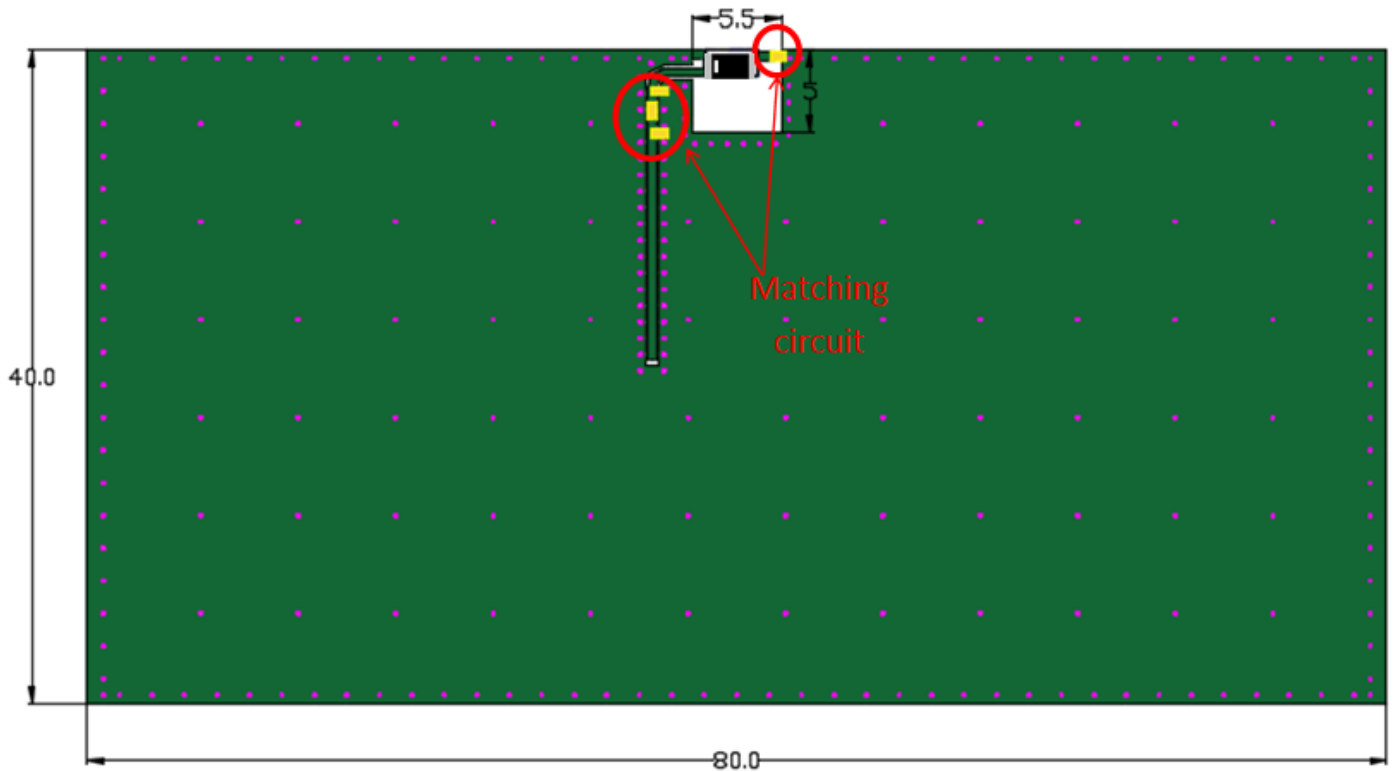

Antenna Layout Reference

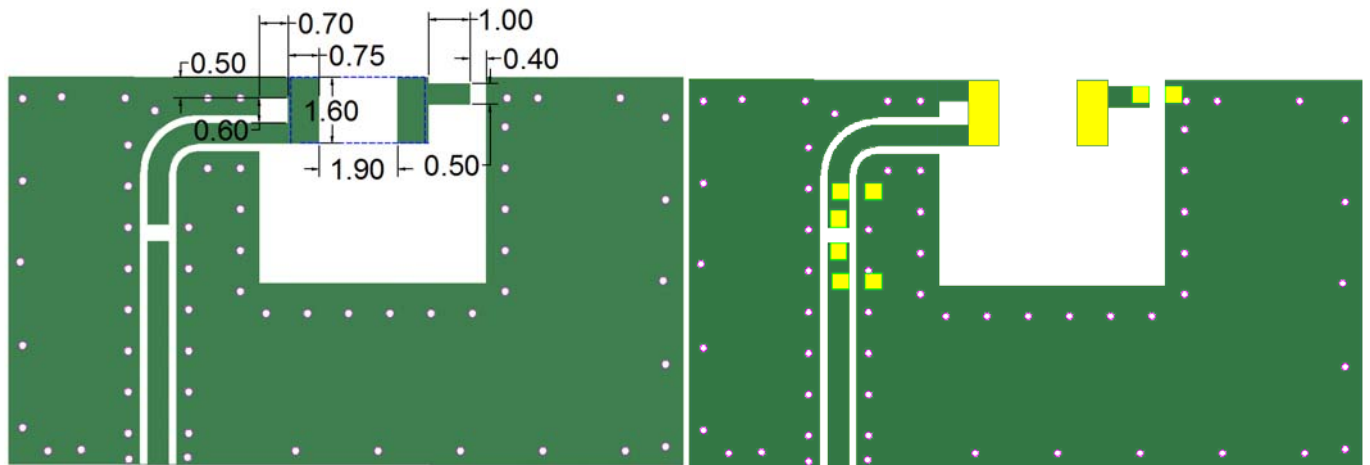

Unit : mm

Electrical Characteristics

VSWR

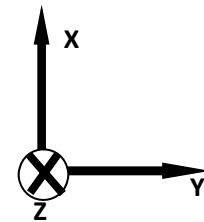
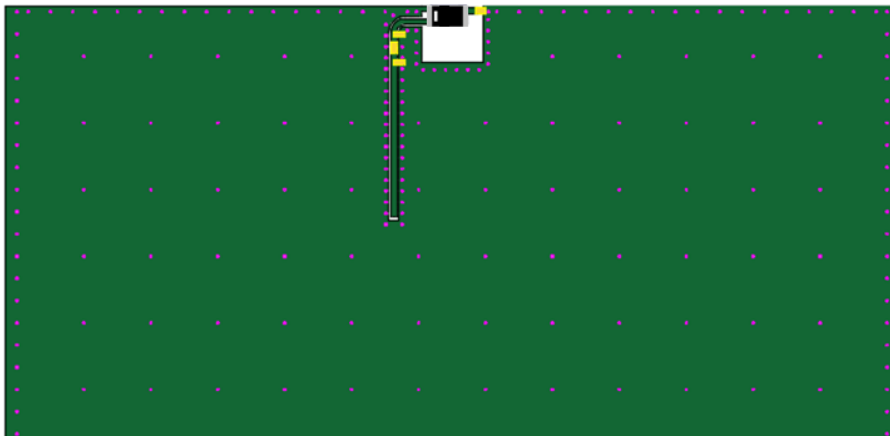
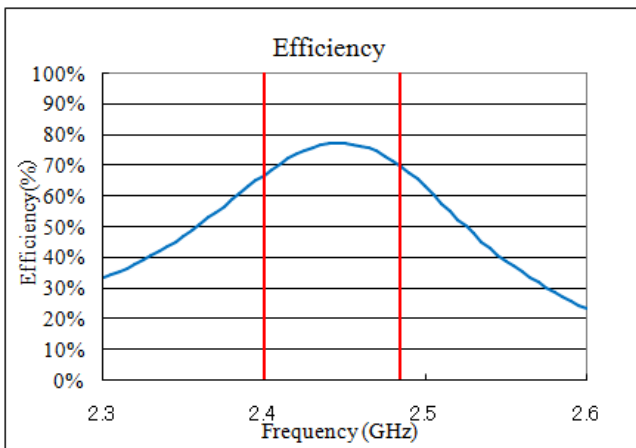
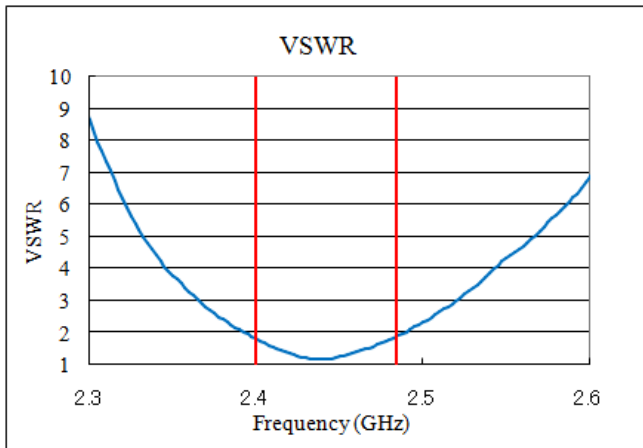

2441.000MHz H

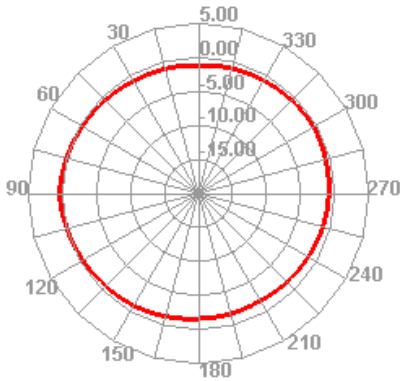

2441.000MHz E1

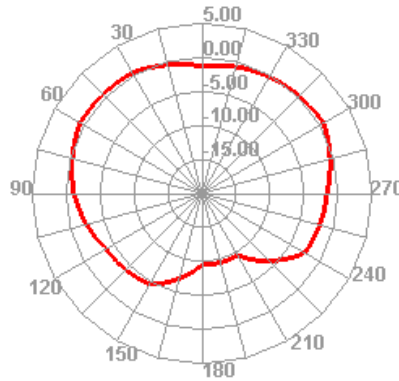

2441.000MHz E2

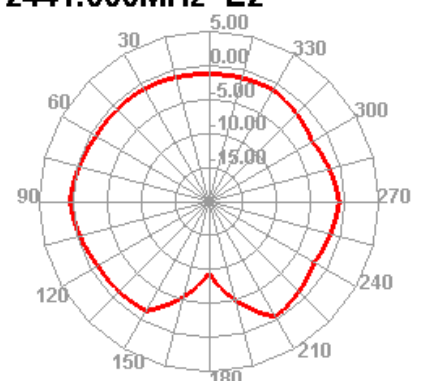

Taping Specifications

Reel and Taping Specification

Reel Specification

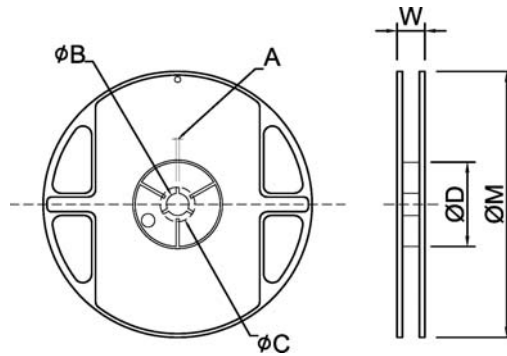

TYPE	SIZE		A	ψB	ψC	ψD	W	ψM
3216	7"	3K/Reel	2.0±0.5	13.5±1.0	21±1.0	60±1.0	11.5±2.0	178±2.0

Taping Specification

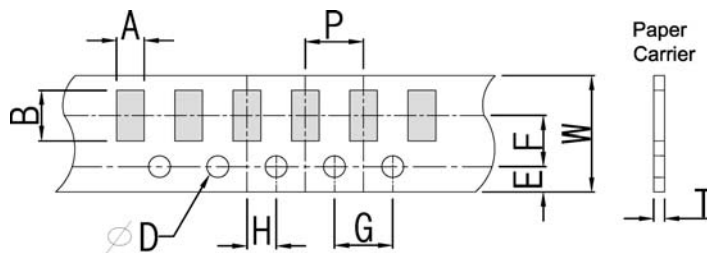

Packaging	Type	A	B	W	E	F	G	H	T	ψD	P
Paper Type	3216	1.90±0.20	3.50±0.20	8.0±0.20	1.75±0.10	3.5±0.05	4.0±0.10	2.0±0.05	0.75±0.10	1.50 +0.10 -0	4.0±0.1

Recommended Reflow Profile

Pb free solder

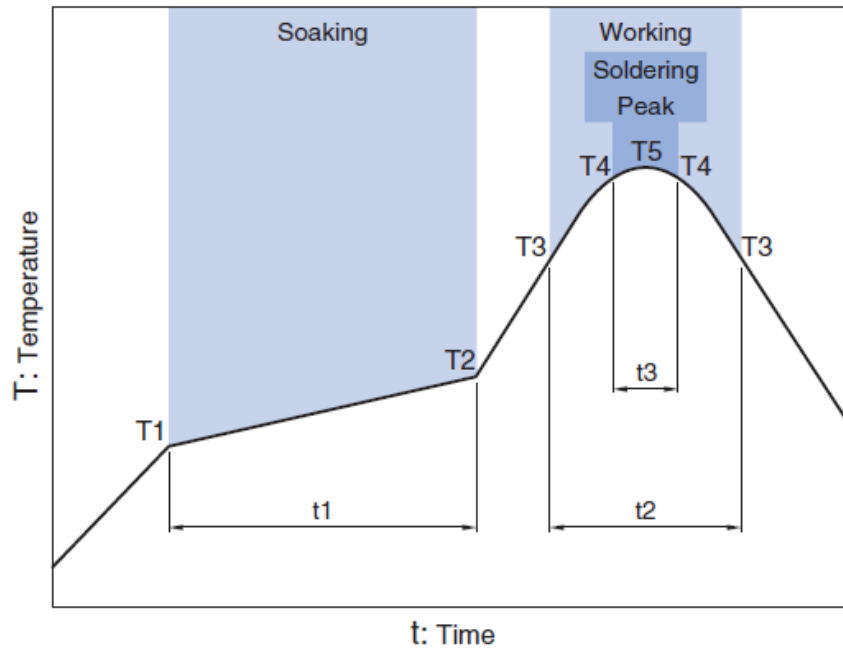

Soaking		Working		Soldering		Peak	
Temp.	Time	Temp.	Time	Temp.	Time	Temp.	
T1	T2	t1	T3	t2	T4	t3	T5
150°C	180°C	60 to 120sec	230°C	more than 30sec	247 to 253°C	within 10sec	260°C Max.

AUG. 2022 Ver.H01