

## 2.4GHz 1608 Chip Antenna: RANT1608F245C01



### Application:

WLAN, 802.11b/g, Bluetooth, WLAN, etc...

### Features

SMD, high reliability, ultra Impact, Omni-directional...



### Part number Information

RANT 1608 F 245 C 01  
(A) (B) (C) (D) (E) (F)

(A) Product Type	Chip Antenna
(B) Size Code	1.6x0.8mm(±0.1mm)
(C) Material	High K material
(D) Frequency	2.4 ~ 2.5GHz
(E) Feeding mode	PIFA & Single Feeding
(F) Antenna type	Type=01

### Electrical Specification

Working Frequency Range	2400 ~2500 MHz
Bandwidth	120 MHz (Min.)
Peak Gain	2.7 dBi (Typ.)
Impedance	50 Ohm
Return loss	10 dB ( Min)
Polarization	Linear
Azimuth Beamwidth	Omni-directional
Operation Temperature(°C)	-40 ~85°C
Resistance to Soldering Heats	10sec. ( @ 280°C)
Termination	Ni / Au (Leadless)

### Dimension and Terminal Configuration

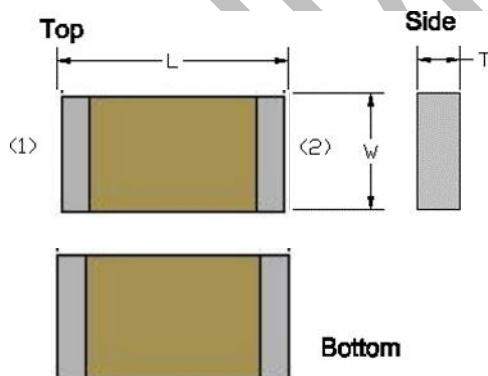

Dimension (mm)	
L	1.60 ± 0.10
W	0.80 ± 0.10
T	0.80 ± 0.10

No.	Terminal Name
1	Feeding/GNG
2	GND/Feeding

RAIN International Technology Co., Ltd.  
709, Building F, Yuxing Science and  
Technology Industrial Park, Nanchang Third  
Industrial Zone, Nanchang Community, Xixiang  
Street, Bao'an District, Shenzhen

電話: 13530576606  
TEL: 13530576606



## Evaluation Board Reference

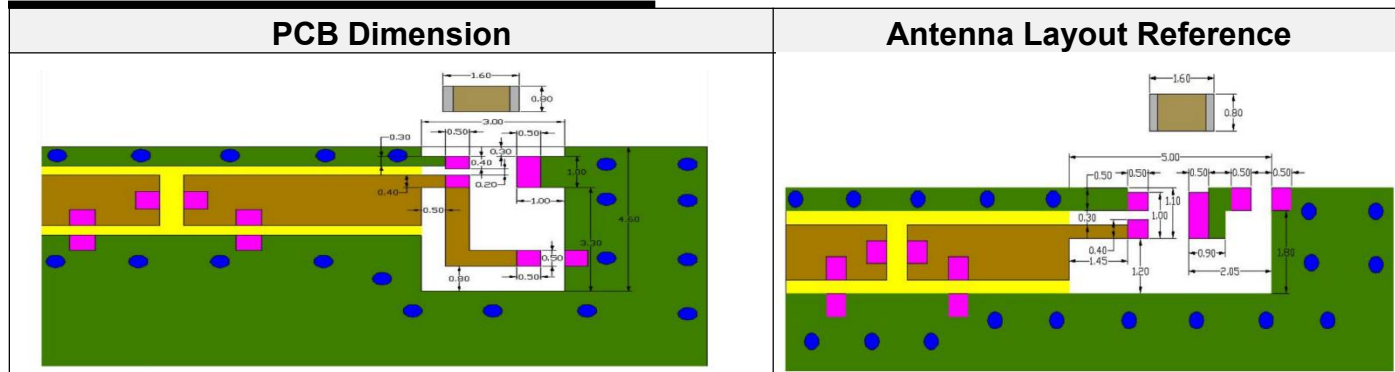

## Electrical Characteristics

### Return Loss & Radiation

## ELECTRICAL CHARACTERISTICSS11

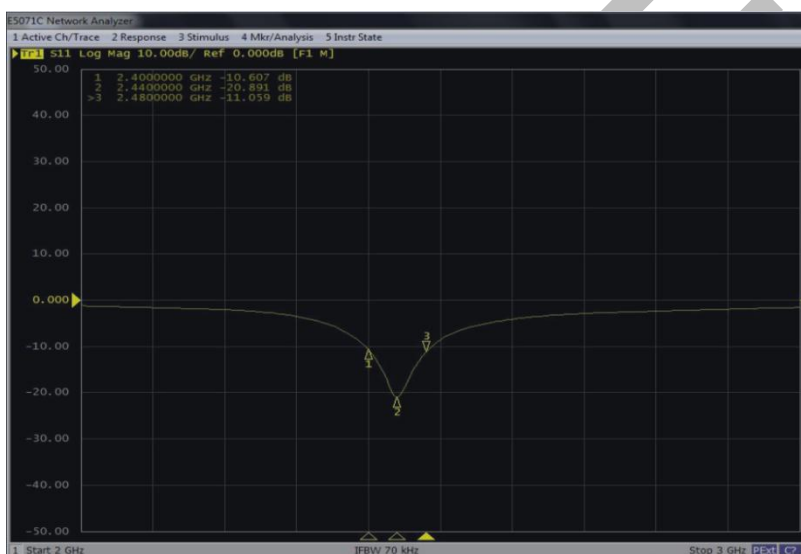

1

## Radiation

Unit: dBi

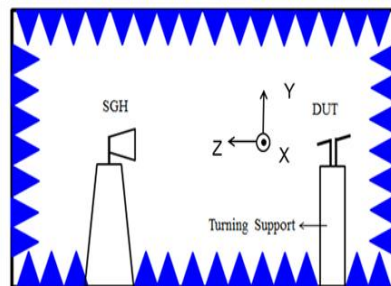
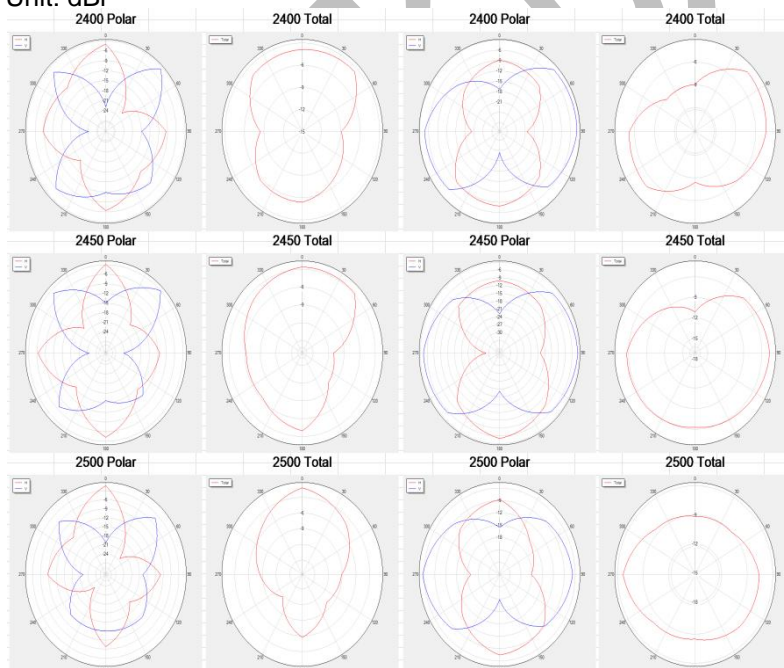

## Electrical Characteristics

Frequency	Efficiency	Percentage	Gain
2400	-1.64	72.27%	2.38
2450	-1.33	75.34%	2.7
2500	-1.59	72.98%	2.59

## Taping Specifications

### Reel and Taping Specification

#### Reel Specification

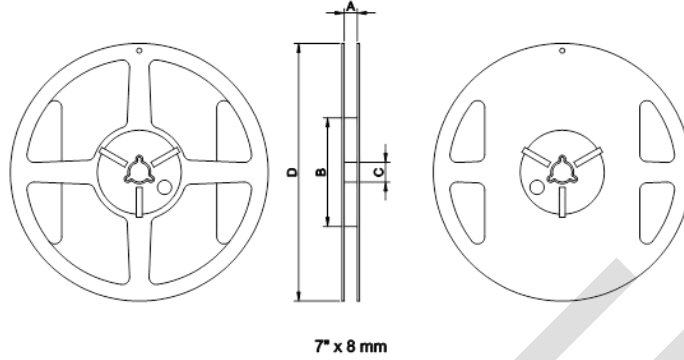

TYPE	SIZE		A	B	C	D
1608	7"	4K/Reel	4.0±0.5	4.0±2	13.5±0.5	178±2

#### Tapping Specification

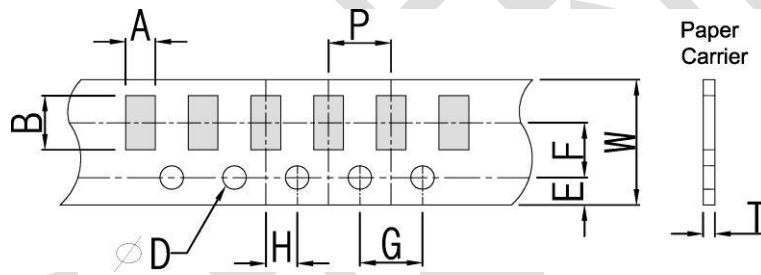

Packaging	Type	A	B	W	E	F	G	H	T	ψD	P
Paper Type	1608	1.90±0.20	3.50±0.20	8.0±0.20	1.75±0.10	3.5±0.05	4.0±0.10	2.0±0.05	0.75±0.10	1.50±0.10	4.0±0.1

## 2.4GHz 1608 Chip Antenna: RANT1608F245C01



### Reliability Table

Test Item	Procedure	Requirements Ceramic Type	Remark (Reference)
<b>Electrical Characterization</b>		Fulfill the electrical specification	User Spec.
<b>Thermal Shock</b>	<ol style="list-style-type: none"> <li>Preconditioning: 50 ± 10°C / 1 hr , then keep for 24 ± 1 hrs at room temp.</li> <li>Initial measure: Spec: refer Initialspec.</li> <li>Rapid change of temperature test: -30°C to +85°C; 100 cycles; 15 minutes at Lower category temperature; 15 minutes at Upper category temperature.</li> </ol>	No Visible Damage. Fulfill the electrical specification.	MIL-STD-202 107
<b>Temperature Cycling</b>	<ol style="list-style-type: none"> <li>Initial measure: Spec: refer Initialspec.</li> <li>100 Cycles (-30°C to +85°C), Soak Mode=1 (2 Cycle/hours).</li> <li>Measurement at 24 ± 2Hours after test condition.</li> </ol>	No Visible Damage. Fulfill the electrical specification.	JESD22 JA104
<b>High Temperature Exposure</b>	<ol style="list-style-type: none"> <li>Initial measure: Spec: refer Initialspec.</li> <li>Unpowered; 500hours @ T=+85°C.</li> <li>Measurement at 24 ± 2 hours aftertest.</li> </ol>	No Visible Damage. Fulfill the electrical specification.	MIL-STD-202 108
<b>Low Temperature Storage</b>	<ol style="list-style-type: none"> <li>Initial measure: Spec: refer Initialspec.</li> <li>Unpowered: 500hours @ T=-30°C.</li> <li>Measurement at 24 ± 2 hours aftertest.</li> </ol>	No Visible Damage. Fulfill the electrical specification.	MIL-STD-202 108
<b>Solderability (SMD Bottom Side)</b>	Dipping method: <ol style="list-style-type: none"> <li>Temperature: 235 ± 5°C</li> <li>Dipping time: 3 ± 0.5s</li> </ol>	The solder should cover over 95% of the critical area of bottom side.	IEC 60384-21/22 4.10
<b>Soldering Heat Resistance (RSH)</b>	Preheating temperature: 150 ± 10°C. Preheating time: 1~2 min. Solder temperature: 260 ± 5°C. Dipping time: 5 ± 0.5s	No Visible Damage.	IEC 60384-21/22 4.10
<b>Vibration</b>	5g's for 20 min., 12 cycles each of 3 orientations Note: Use 8"X5" PCB .031" thick 7 secure points on, one long side and 2 secure points at corners of opposite sides. Parts mounted within 2" from any secure point. Test from 10-2000 Hz.	No Visible Damage.	MIL-STD-202 Method 204
<b>Mechanical Shock</b>	Three shocks in each direction shall be applied along the three mutually perpendicular axes of the test specimen (18 shocks) Peak value: 1,500g's Duration: 0.5ms Velocity change: 15.4 ft/s Waveform: Half-sine	No Visible Damage.	MIL-STD-202 Method 213
<b>Humidity Bias</b>	<ol style="list-style-type: none"> <li>Humidity: 85% R.H., Temperature: 85 ± 2 °C.</li> <li>Time: 500 ± 24 hours.</li> <li>Measurement at 24 ± 2hrs after test condition.</li> </ol>	No Visible Damage. Fulfill the electrical specification.	MIL-STD-202 Method 106

## 2.4GHz 3216 Chip Antenna: RANT1608F245C01

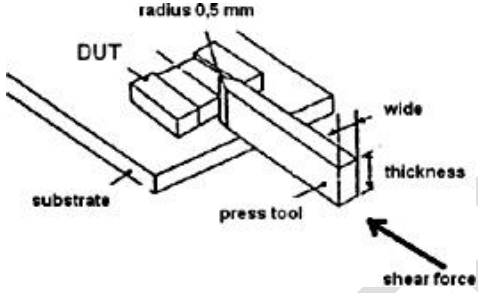
<b>Board Flex (SMD)</b>	<p>1. Mounting method: IR-Reflow. PCB Size (L:100 × W:40 × T:1.6mm)</p> <p>2. Apply the load in direction of the arrow until bending reaches 2 mm.</p>	<p>No Visible Damage.</p>	<p>AEC-Q200 005</p>
<b>Adhesion</b>	<p>Force of 1.8Kg for 60 seconds.</p> 	<p>No Visible Damage Magnification of 20X or greater may be employed for inspection of the mechanical integrity of the device body terminals and body/terminal junction.</p>	<p>AEC-Q200 006</p>
<b>Physical Dimension</b>	<p>Any applicable method using x10 magnification, micrometers, calipers, gauges, contour projectors, or other measuring equipment, capable of determining the actual specimen dimensions.</p>	<p>In accordance with specification.</p>	<p>JESD22 JB100</p>

### Revision History

Revision	Date	Content
1	2019/03/01	New Datasheet
2	2020/02/22	Add 2D radiation characteristic