

2.4GHz 2012 Chip Antenna: ANT2012R24005KL0

Applications:

WLAN, 802.11b/g, Bluetooth, etc...

Features

SMD, high reliability, ultra compact, Omni-directional...

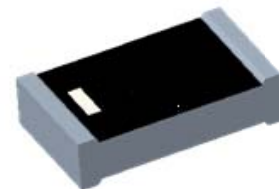

Part number

ANT 2012 R 2400 5K L0
 (1) (2) (3) (4) (5)

(1) Size Code	2.0x1.2mm
(2) Packing	Tape and reel
(3) Frequency	2.4GHz
(4) Packing Number	5K
(5) Code	L0

Electrical Specification

Working Frequency Range	2400 ~2484 MHz
Peak Gain	1.01 dBi (Typ.)
Impedance	50 Ohm
VSWR	2.5 (Max)
Polarization	Linear
Azimuth Beamwidth	Omni-directional
Operation Temperature(°C)	-40~85(°C)

The specification is defined on EVB.

Dimension and Terminal Configuration

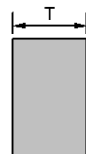
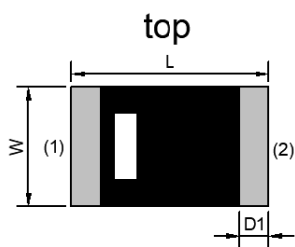

Dimension (mm)	
L	2.00±0.15
W	1.20±0.15
T	0.50±0.10
D1	0.30±0.15
D2	0.60±0.15

No.	Terminal Name
1	Feeding
2	GND

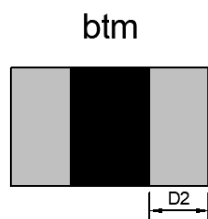

Evaluation Board Reference

PCB Dimension

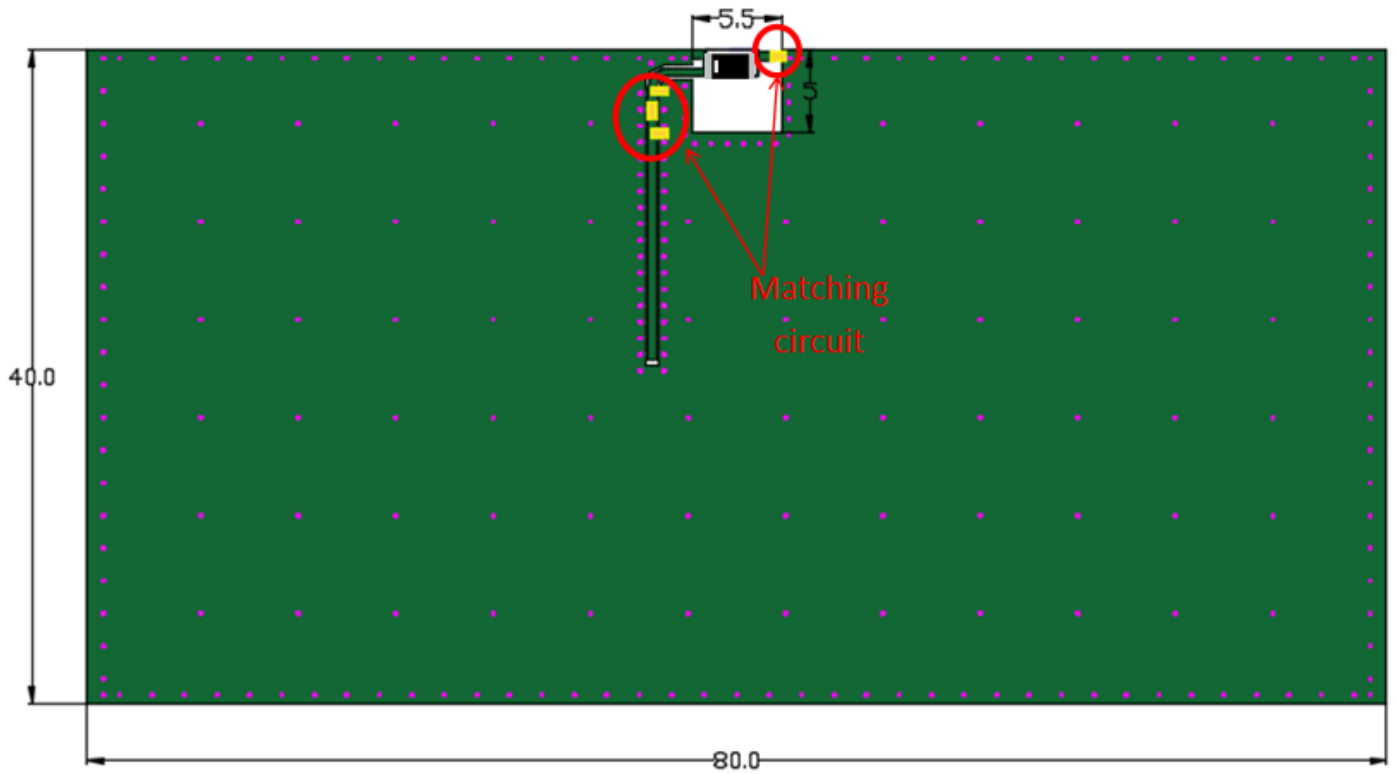

Antenna Layout Reference

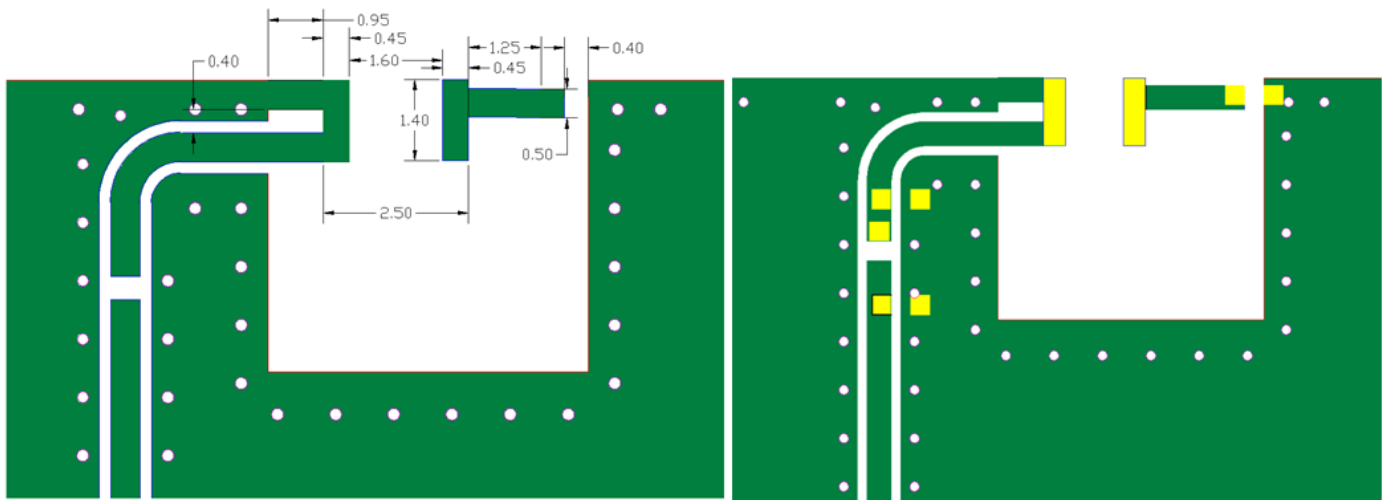

Unit : mm

Electrical Characteristics

VSWR&Efficiency

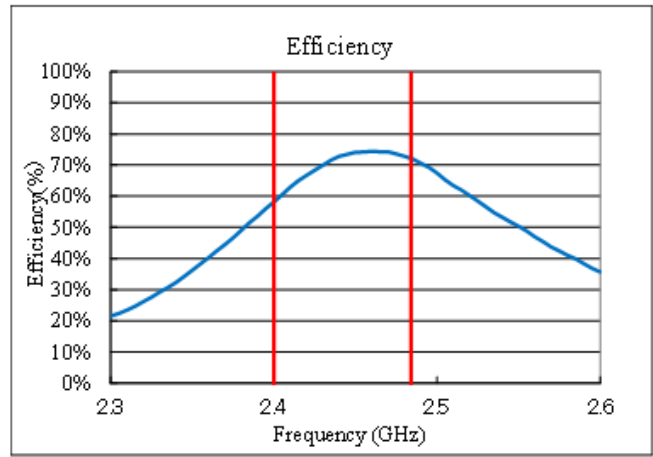
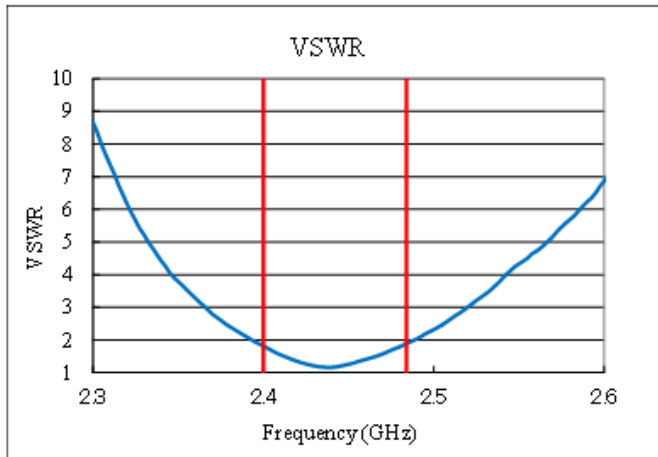

Radiation Pattern

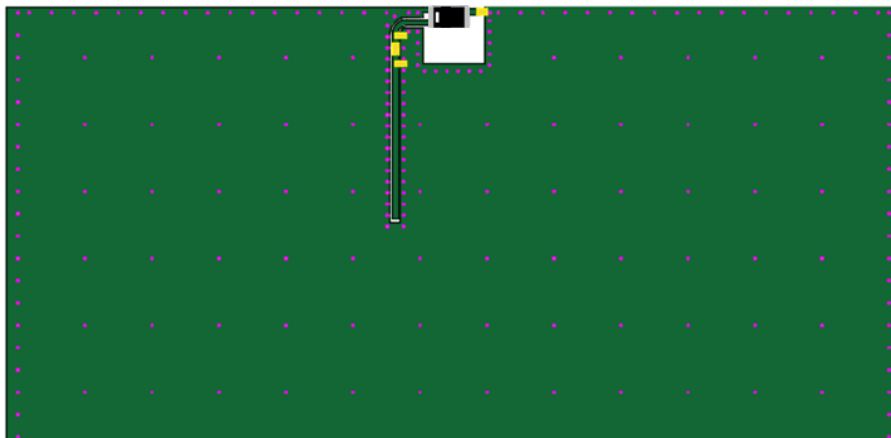

2441.000MHz H

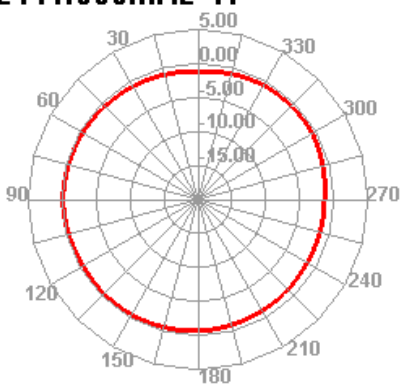

2441.000MHz E1

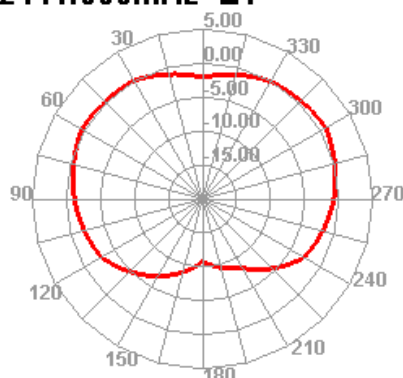

2441.000MHz E2

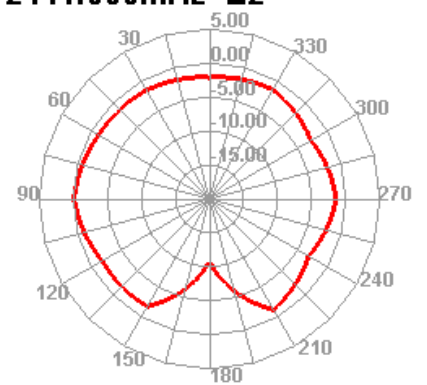

Taping Specifications

Reel and Taping Specification

Reel Specification

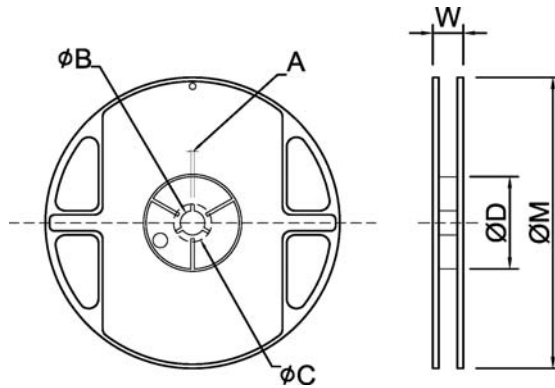

TYPE	SIZE		A	ψB	ψC	ψD	W	ψM
2012	7"	5K/Reel	2.0±0.5	13.5±1.0	21±1.0	60±1.0	11.5±2.0	178±2.0

Tapping Specification

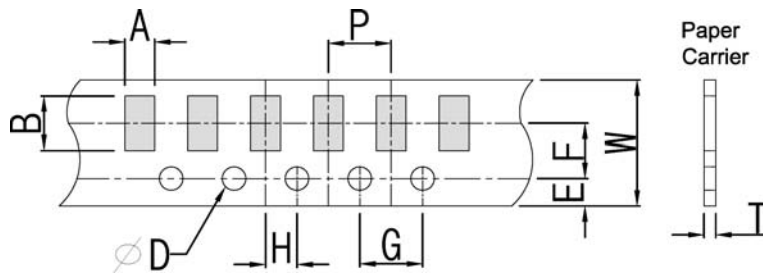

Packaging	Type	A	B	W	E	F	G	H	T	ψD	P
Paper Type	2012	1.50±0.20	2.20±0.20	8.0±0.20	1.75±0.10	3.5±0.05	4.0±0.10	2.0±0.05	0.80±0.10	1.50 +0.10 -0	4.0±0.1

Recommended Reflow Profile

Pb free solder

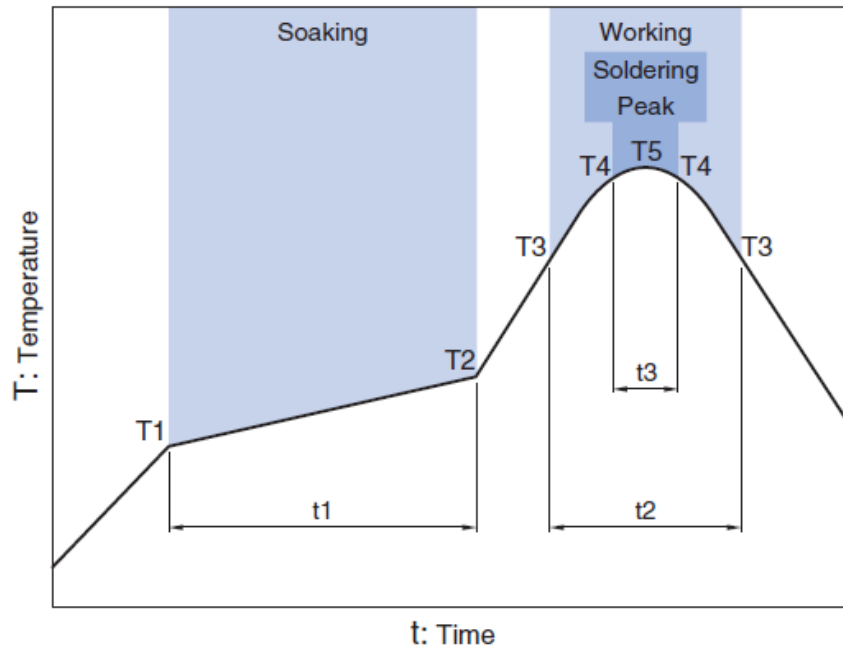

Soaking		Working		Soldering		Peak	
Temp.	Time	Temp.	Time	Temp.	Time	Temp.	
T1	T2	t1	T3	t2	T4	t3	T5
150°C	180°C	60 to 120sec	230°C	more than 30sec	247 to 253°C	within 10sec	260°C Max.

AUG 2022 Ver.H01