

# TEST REPORT

Report No.: BCTC2312543311E

---

Applicant: Shenzhen Baseus Technology Co., Ltd.

---

Product Name: Baseus Wireless Headphones

---

Test Model: Baseus Bass 35 Max

---

Tested Date: 2023-12-29 to 2024-01-02

---

Issued Date: 2024-01-05

---



**Shenzhen BCTC Testing Co., Ltd.**



# FCC ID: 2A482-BASS35MAX

Product Name: Baseus Wireless Headphones  
Trademark: baseus  
Model/Type Reference: Baseus Bass 35 Max  
Baseus Bass 30 Max, Baseus Bass 35 max, Baseus Bass 30 max  
Prepared For: Shenzhen Baseus Technology Co., Ltd.  
Address: 2nd Floor, Building B, Baseus Intelligence Park, No.2008, Xuegang Rd, Gangtou Community, Bantian Street, Longgang District, Shenzhen, China.  
Manufacturer: Shenzhen Baseus Technology Co., Ltd.  
Address: 2nd Floor, Building B, Baseus Intelligence Park, No.2008, Xuegang Rd, Gangtou Community, Bantian Street, Longgang District, Shenzhen, China.  
Prepared By: Shenzhen BCTC Testing Co., Ltd.  
Address: 1-2/F., Building B, Pengzhou Industrial Park, No.158, Fuyuan 1st Road, Zhancheng, Fuhai Subdistrict, Bao'an District, Shenzhen, Guangdong, China  
Sample Received Date: 2023-12-29  
Sample Tested Date: 2023-12-29 to 2024-01-02  
Issue Date: 2024-01-05  
Report No.: BCTC2312543311E  
Test Standards: FCC Part15.247  
ANSI C63.10-2013  
Test Results: PASS  
Remark: This is Bluetooth Classic radio test report.

Tested by:

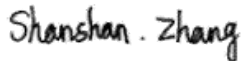

Shanshan. Zhang / Project Handler

Approved by:



Zero Zhou/Reviewer

The test report is effective only with both signature and specialized stamp. This result(s) shown in this report refer only to the sample(s) tested. Without written approval of Shenzhen BCTC Testing Co., Ltd, this report can't be reproduced except in full. The tested sample(s) and the sample information are provided by the client.



## Table Of Content

Test Report Declaration	Page
1. Version .....	5
2. Test Summary .....	6
3. Measurement Uncertainty .....	7
4. Product Information And Test Setup .....	8
4.1 Product Information.....	8
4.2 Test Setup Configuration .....	9
4.3 Support Equipment .....	9
4.4 Channel List.....	10
4.5 Test Mode .....	10
4.6 Table Of Parameters Of Text Software Setting.....	10
5. Test Facility And Test Instrument Used.....	11
5.1 Test Facility.....	11
5.2 Test Instrument Used.....	11
6. Conducted Emissions.....	13
6.1 Block Diagram Of Test Setup.....	13
6.2 Limit .....	13
6.3 Test procedure.....	13
6.4 EUT operating Conditions .....	13
6.5 Test Result.....	14
7. Radiated emissions .....	16
7.1 Block Diagram Of Test Setup.....	16
7.2 Limit .....	17
7.3 Test procedure.....	18
7.4 EUT operating Conditions .....	19
7.5 Test Result.....	19
8. Radiated Band Emission Measurement And Restricted Bands Of Operation .....	25
8.1 Block Diagram Of Test Setup.....	25
8.2 Limit .....	25
8.3 Test procedure.....	26
8.4 EUT operating Conditions .....	26
8.5 Test Result.....	27
9. Spurious RF Conducted Emissions.....	28
9.1 Block Diagram Of Test Setup.....	28
9.2 Limit .....	28
9.3 Test procedure.....	28
9.4 Test Result.....	29
10. 20 dB Bandwidth .....	50
10.1 Block Diagram Of Test Setup.....	50
10.2 Limit .....	50
10.3 Test procedure.....	50
10.4 Test Result.....	50
11. Maximum Peak Output Power.....	56
11.1 Block Diagram Of Test Setup.....	56
11.2 Limit .....	56
11.3 Test procedure.....	56
11.4 Test Result.....	56

BCTC  
 BCTC  
 PPR  
 Report

12. Hopping Channel Separation .....	62
12.1 Block Diagram Of Test Setup.....	62
12.2 Limit .....	62
12.3 Test procedure.....	62
12.4 Test Result.....	62
13. Number Of Hopping Frequency.....	68
13.1 Block Diagram Of Test Setup.....	68
13.2 Limit .....	68
13.3 Test procedure.....	68
13.4 Test Result.....	68
14. Dwell Time.....	71
14.1 Block Diagram Of Test Setup.....	71
14.2 Limit .....	71
14.3 Test procedure.....	71
14.4 Test Result.....	71
15. Antenna Requirement .....	81
15.1 Limit .....	81
15.2 Test Result.....	81
16. EUT Photographs.....	82
17. EUT Test Setup Photographs.....	83

(Note: N/A Means Not Applicable)

**1. Version**

Report No.	Issue Date	Description	Approved
BCTC2312543311E	2024-01-05	Original	Valid

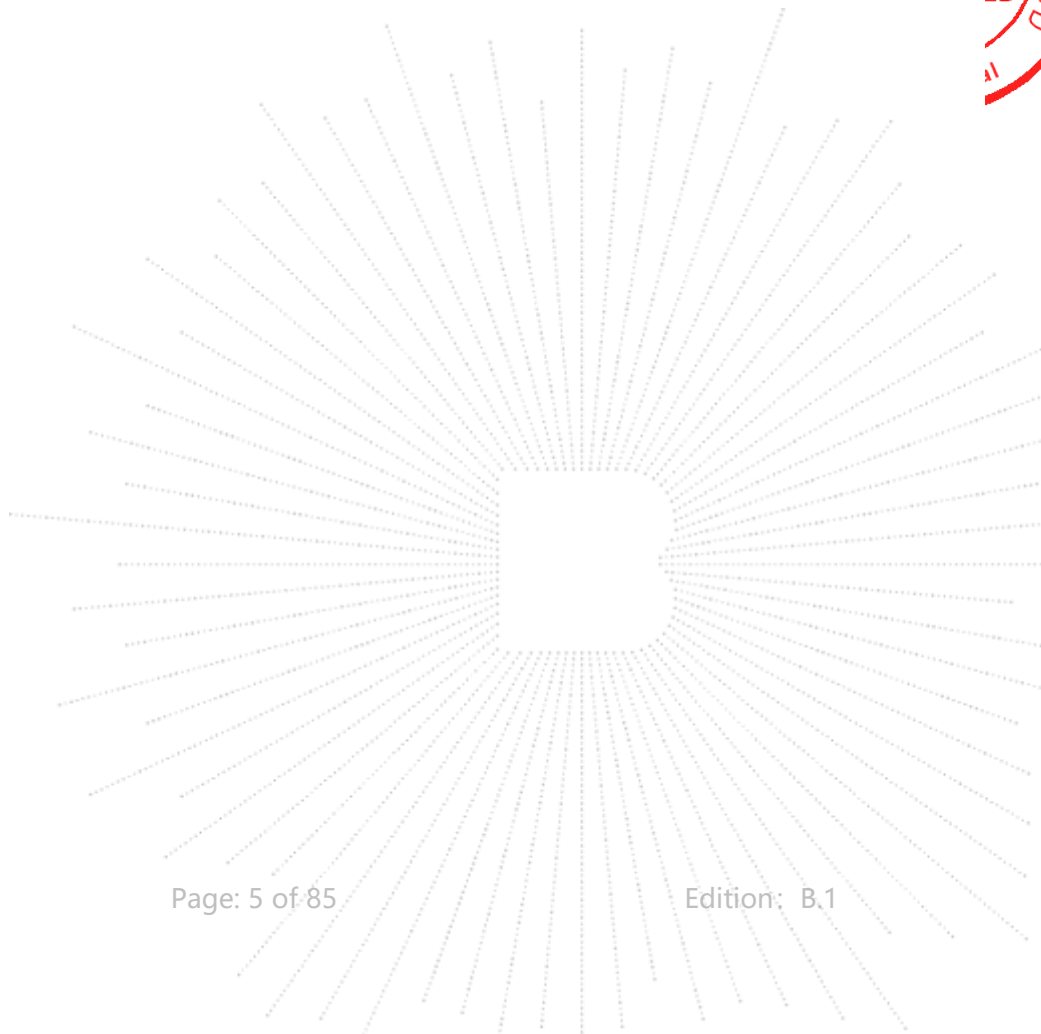

## 2. Test Summary

The Product has been tested according to the following specifications:

No.	Test Parameter	Clause No	Results
1	Conducted emission AC power port	§15.207	PASS
2	Conducted peak output power for FHSS	§15.247(b)(1)	PASS
3	20dB Occupied bandwidth	§15.247(a)(1)	PASS
4	Hopping channel separation	§15.247(a)(1)	PASS
5	Number of hopping frequencies	§15.247(a)(1)(iii)	PASS
6	Dwell Time	§15.247(a)(1)(iii)	PASS
7	Spurious RF conducted emissions	§15.247(d)	PASS
8	Band edge	§15.247(d)	PASS
9	Spurious radiated emissions for transmitter	§15.247(d) & §15.209 & §15.205	PASS
10	Antenna Requirement	15.203	PASS

CO., LTD

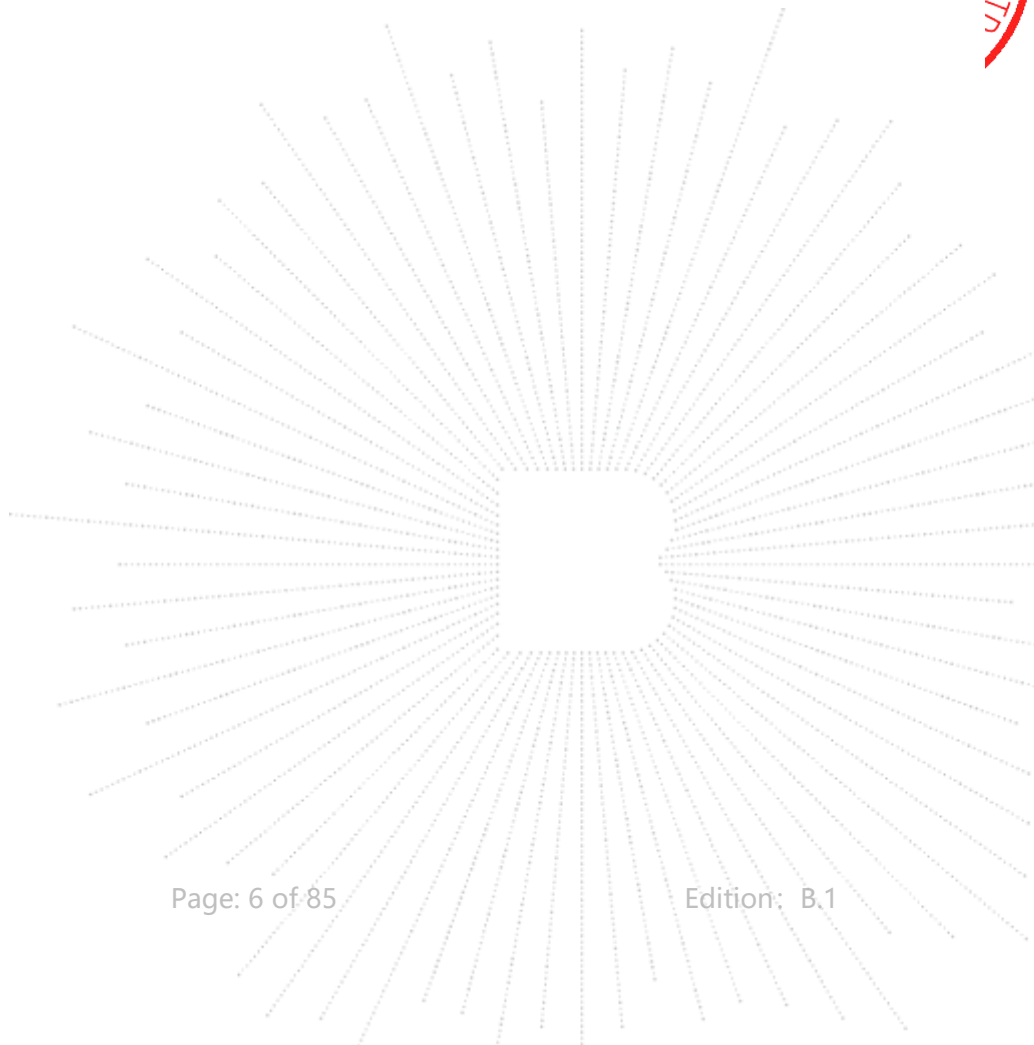

### 3. Measurement Uncertainty

Where relevant, the following measurement uncertainty levels have been estimated for tests performed on the Product as specified in CISPR 16-4-2. This uncertainty represents an expanded uncertainty expressed at approximately the 95% confidence level using a coverage factor of  $k=2$ .

No.	Item	Uncertainty
1	3m chamber Radiated spurious emission(30MHz-1GHz)	U=4.3dB
2	3m chamber Radiated spurious emission(9KHz-30MHz)	U=3.7dB
3	3m chamber Radiated spurious emission(1GHz-18GHz)	U=4.5dB
4	3m chamber Radiated spurious emission(18GHz-40GHz)	U=3.34dB
5	Conducted Emission (150kHz-30MHz)	U=3.20dB
6	Conducted Adjacent channel power	U=1.38dB
7	Conducted output power uncertainty Above 1G	U=1.576dB
8	Conducted output power uncertainty below 1G	U=1.28dB
9	humidity uncertainty	U=5.3%
10	Temperature uncertainty	U=0.59°C

SHENZHEN



## 4. Product Information And Test Setup

### 4.1 Product Information

Model/Type Reference:	Baseus Bass 35 Max Baseus Bass 30 Max, Baseus Bass 35 max, Baseus Bass 30 max
Model Differences:	All the models are the same circuit and RF module, except model names and appearance of the color.
Hardware Version:	N/A
Software Version:	N/A
Operation Frequency:	2402-2480MHz
Type of Modulation:	GFSK, $\pi/4$ DQPSK, 8DPSK
Number Of Channel:	79CH
Antenna installation:	PCB antenna
Antenna Gain:	-0.58 dBi
Ratings:	DC 5V from adapter or DC 3.7V from battery
Remark:	The antenna gain of the product comes from the antenna report provided by the customer, and the test data is affected by the customer information.





## 4.2 Test Setup Configuration

See test photographs attached in *EUT TEST SETUP PHOTOGRAPHS* for the actual connections between Product and support equipment.

Conducted Emission:

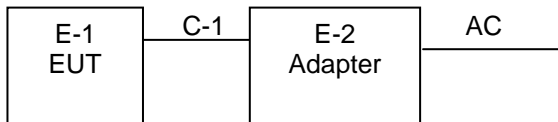

Radiated Spurious Emission:

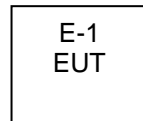

## 4.3 Support Equipment

No.	Device Type	Brand	Model	Series No.	Note
E-1	Baseus Wireless Headphones	baseus	Baseus Bass 35 Max	Baseus Bass 30 Max, Baseus Bass 35 max, Baseus Bass 30 max	EUT
E-2	ADAPTER	Hoco.	N18	N/A	Auxiliary

Item	Shielded Type	Ferrite Core	Length	Note
C-1	N/A	N/A	0.5M	DC cable unshielded

Notes:

- All the equipment/cables were placed in the worst-case configuration to maximize the emission during the test.
- Grounding was established in accordance with the manufacturer's requirements and conditions for the intended use.

#### 4.4 Channel List

CH	Frequency (MHz)	CH	Frequency (MHz)	CH	Frequency (MHz)	CH	Frequency (MHz)
0	2402	1	2403	2	2404	3	2405
4	2406	5	2407	6	2408	7	2409
8	2410	9	2411	10	2412	11	2413
12	2414	13	2415	14	2416	15	2417
16	2418	17	2419	18	2420	19	2421
20	2422	21	2423	22	2424	23	2425
24	2426	25	2427	26	2428	27	2429
28	2430	29	2431	30	2432	31	2433
32	2434	33	2435	34	2436	35	2437
36	2438	37	2439	38	2440	39	2441
40	2442	41	2443	42	2444	43	2445
44	2446	45	2447	46	2448	47	2449
48	2450	49	2451	50	2452	51	2453
52	2454	53	2455	54	2456	55	2457
56	2458	57	2459	58	2460	59	2461
60	2462	61	2463	62	2464	63	2465
64	2466	65	2467	66	2468	67	2469
68	2470	69	2471	70	2472	71	2473
72	2474	73	2475	74	2476	75	2477
76	2478	77	2479	78	2480	79	/

#### 4.5 Test Mode

To investigate the maximum EMI emission characteristics generated from EUT, the test system was pre-scanning tested based on the consideration of following EUT operation mode or test configuration mode which possibly have effect on EMI emission level. Each of these EUT operation mode(s) or test configuration mode(s) mentioned above was evaluated respectively.

Test Mode	Test mode	Low channel	Middle channel	High channel
1	Transmitting(GFSK)	2402MHz	2441MHz	2480MHz
2	Transmitting( $\pi/4$ DQPSK)	2402MHz	2441MHz	2480MHz
3	Transmitting(8DPSK)	2402MHz	2441MHz	2480MHz
4	Transmitting (Conducted emission & Radiated emission)			

Note:

- (1) The measurements are performed at the highest, middle, lowest available channels.
- (2) Fully-charged battery is used during the test

#### 4.6 Table Of Parameters Of Text Software Setting

During testing channel & power controlling software provided by the customer was used to control the operating channel as well as the output power level. The RF output power selection is for the setting of RF output power expected by the customer and is going to be fixed on the firmware of the final end product power parameters

Test software Version	BT_Tool		
Frequency	2402 MHz	2441 MHz	2480 MHz
Parameters	DEF	DEF	DEF

## 5. Test Facility And Test Instrument Used

### 5.1 Test Facility

All measurement facilities used to collect the measurement data are located at Shenzhen BCTC Testing Co., Ltd. Address:1-2/F., Building B, Pengzhou Industrial Park, No.158, Fuyuan 1st Road, Zhancheng, Fuhai Subdistrict, Bao'an District, Shenzhen, Guangdong, China. The site and apparatus are constructed in conformance with the requirements of ANSI C63.4 and CISPR 16-1-1 other equivalent standards.

FCC Test Firm Registration Number: 712850

A2LA certificate registration number is: CN1212

ISED Registered No.: 23583

ISED CAB identifier: CN0017

### 5.2 Test Instrument Used

Conducted Emissions Test					
Equipment	Manufacturer	Model#	Serial#	Last Cal.	Next Cal.
Receiver	R&S	ESR3	102075	May 15, 2023	May 14, 2024
LISN	R&S	ENV216	101375	May 15, 2023	May 14, 2024
Software	Frad	EZ-EMC	EMC-CON 3A1	\	\
Pulse limiter	Schwarzbeck	VTSD9561-F	01323	Sept. 22, 2023	Sept. 21, 2024

RF Conducted Test					
Equipment	Manufacturer	Model#	Serial#	Last Cal.	Next Cal.
Power Metter	Keysight	E4419	\	May 15, 2023	May 14, 2024
Power Sensor (AV)	Keysight	E9300A	\	May 15, 2023	May 14, 2024
Signal Analyzer20kHz-26.5GHz	Keysight	N9020A	MY49100060	May 15, 2023	May 14, 2024
Spectrum Analyzer9kHz-40GHz	R&S	FSP40	100363	May 15, 2023	May 14, 2024
Radio frequency control box	MAIWEI	MW100-RFC B	\	\	\
Software	MAIWEI	MTS 8310	\	\	\

Radiated Emissions Test (966 Chamber01)					
Equipment	Manufacturer	Model#	Serial#	Last Cal.	Next Cal.
966 chamber	ChengYu	966 Room	966	May 15, 2023	May 14, 2026
Receiver	R&S	ESR3	102075	May 15, 2023	May 14, 2024
Receiver	R&S	ESRP	101154	May 15, 2023	May 14, 2024
Amplifier	Schwarzbeck	BBV9744	9744-0037	May 15, 2023	May 14, 2024
TRILOG Broadband Antenna	Schwarzbeck	VULB9163	942	May 29, 2023	May 28, 2024
Loop Antenna(9KHz -30MHz)	Schwarzbeck	FMZB1519B	00014	May 31, 2023	May 30, 2024
Amplifier	SKET	LAPA_01G18 G-45dB	SK2021040901	May 15, 2023	May 14, 2024
Horn Antenna	Schwarzbeck	BBHA9120D	1541	May 31, 2023	May 30, 2024
Amplifier(18G Hz-40GHz)	MITEQ	TTA1840-35-HG	2034381	May 15, 2023	May 14, 2024
Horn Antenn(18GHz-40GHz)	Schwarzbeck	BBHA9170	00822	May 31, 2023	May 30, 2024
Spectrum Analyzer9kHz-40GHz	R&S	FSP40	100363	May 15, 2023	May 14, 2024
Software	Frad	EZ-EMC	FA-03A2 RE	\	\

CO.,LTD

## 6. Conducted Emissions

### 6.1 Block Diagram Of Test Setup



### 6.2 Limit

Frequency (MHz)	Limit (dBuV)	
	Quas-peak	Average
0.15 -0.5	66 - 56 *	56 - 46 *
0.50 -5.0	56.00	46.00
5.0 -30.0	60.00	50.00

Notes:  
 1. \*Decreasing linearly with logarithm of frequency.  
 2. The lower limit shall apply at the transition frequencies.

### 6.3 Test procedure

Receiver Parameters	Setting
Attenuation	10 dB
Start Frequency	0.15 MHz
Stop Frequency	30 MHz
IF Bandwidth	9 kHz

- The Product was placed on a nonconductive table 0.8 m above the horizontal ground reference plane, and 0.4 m from the vertical ground reference plane, and connected to the main through Line Impedance Stability Network (L.I.S.N).
- The RBW of the receiver was set at 9 kHz in 150 kHz ~ 30MHz with Peak and AVG detector in Max Hold mode. Run the receiver's pre-scan to record the maximum disturbance generated from Product in all power lines in the full band.
- For each frequency whose maximum record was higher or close to limit, measure its QP and AVG values and record.

### 6.4 EUT operating Conditions

The EUT was configured for testing in a typical fashion (as a customer would normally use it). The EUT has been programmed to continuously transmit during test. This operating condition was tested and used to collect the included data.

## 6.5 Test Result

Temperature:	26 °C	Relative Humidity:	54%
Pressure:	101KPa	Test Voltage:	AC 120V/60Hz
Test Mode:	Mode 4	Polarization:	L

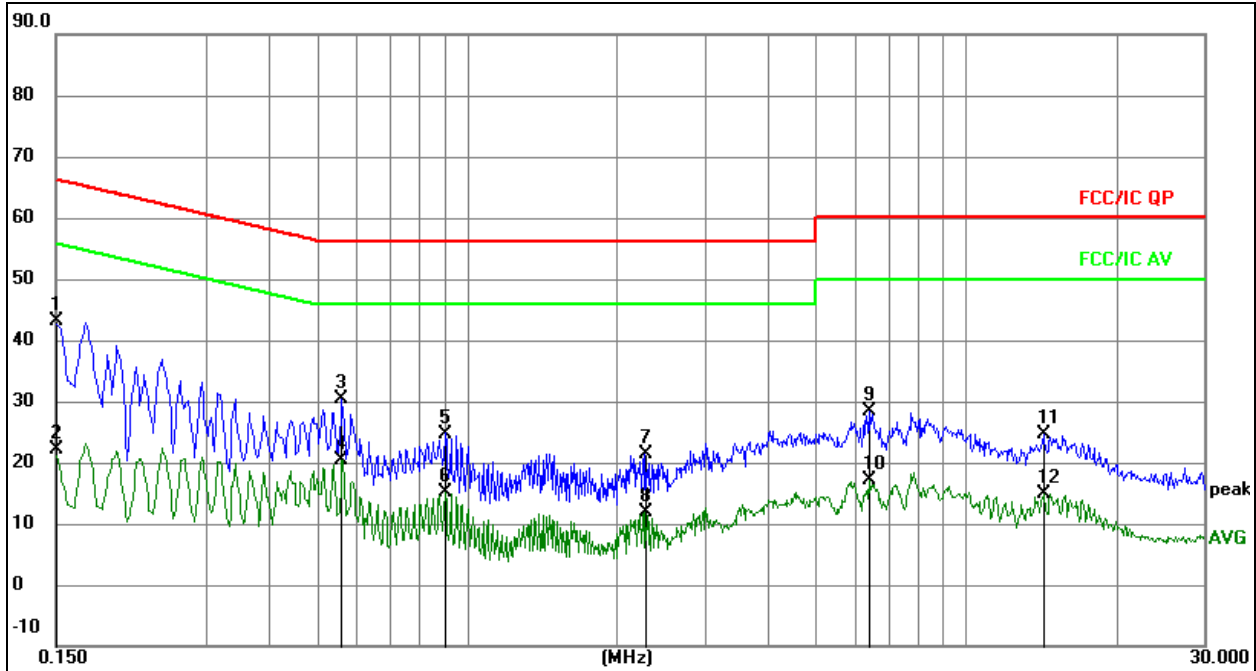

## Remark:

1. All readings are Quasi-Peak and Average values.
2. Factor = Insertion Loss + Cable Loss.
3. Measurement = Reading Level + Correct Factor
4. Over = Measurement - Limit

No.	Mk.	Freq. MHz	Reading Level	Correct Factor dB	Measure- ment dBuV	Limit dBuV	Over dB	Detector
1	*	0.1500	23.28	19.73	43.01	66.00	-22.99	QP
2		0.1500	2.46	19.73	22.19	56.00	-33.81	AVG
3		0.5611	10.61	19.84	30.45	56.00	-25.55	QP
4		0.5611	0.50	19.84	20.34	46.00	-25.66	AVG
5		0.9039	4.84	19.91	24.75	56.00	-31.25	QP
6		0.9039	-4.75	19.91	15.16	46.00	-30.84	AVG
7		2.2726	1.41	20.05	21.46	56.00	-34.54	QP
8		2.2726	-8.11	20.05	11.94	46.00	-34.06	AVG
9		6.3859	8.39	20.10	28.49	60.00	-31.51	QP
10		6.3859	-2.96	20.10	17.14	50.00	-32.86	AVG
11		14.2882	4.78	19.88	24.66	60.00	-35.34	QP
12		14.2882	-5.09	19.88	14.79	50.00	-35.21	AVG

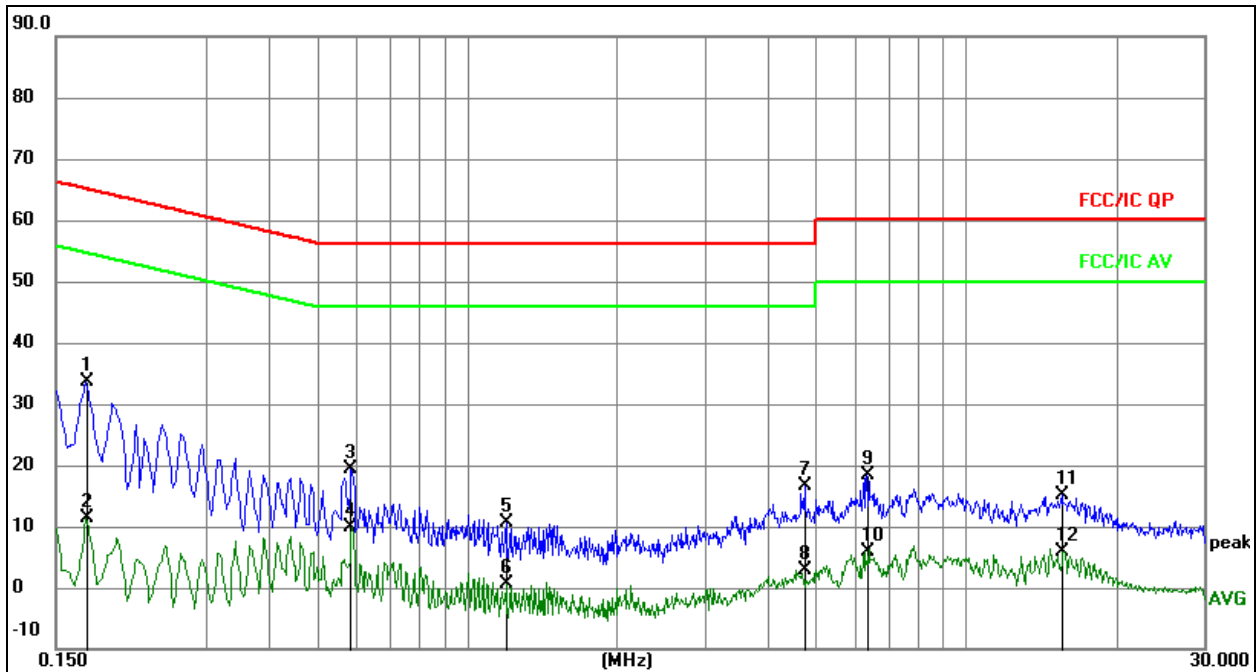

Temperature:	26 °C	Relative Humidity:	54%
Pressure:	101KPa	Test Voltage:	AC 120V/60Hz
Test Mode:	Mode 4	Polarization:	N

**Remark:**

1. All readings are Quasi-Peak and Average values.
2. Factor = Insertion Loss + Cable Loss.
3. Measurement = Reading Level + Correct Factor
4. Over = Measurement - Limit

No.	Mk.	Freq. MHz	Reading Level	Correct Factor dB	Measure- ment dBuV	Limit dBuV	Over dB	Detector
1	*	0.1722	13.74	19.77	33.51	64.85	-31.34	QP
2		0.1722	-8.38	19.77	11.39	54.85	-43.46	AVG
3		0.5854	-0.51	19.84	19.33	56.00	-36.67	QP
4		0.5854	-9.98	19.84	9.86	46.00	-36.14	AVG
5		1.1970	-9.33	19.95	10.62	56.00	-45.38	QP
6		1.1970	-19.41	19.95	0.54	46.00	-45.46	AVG
7		4.7464	-3.79	20.49	16.70	56.00	-39.30	QP
8		4.7464	-17.70	20.49	2.79	46.00	-43.21	AVG
9		6.3186	-1.73	20.12	18.39	60.00	-41.61	QP
10		6.3186	-14.21	20.12	5.91	50.00	-44.09	AVG
11		15.5523	-4.82	19.89	15.07	60.00	-44.93	QP
12		15.5523	-13.97	19.89	5.92	50.00	-44.08	AVG



## 7. Radiated emissions

### 7.1 Block Diagram Of Test Setup

(A) Radiated Emission Test-Up Frequency Below 30MHz



(B) Radiated Emission Test-Up Frequency 30MHz~1GHz

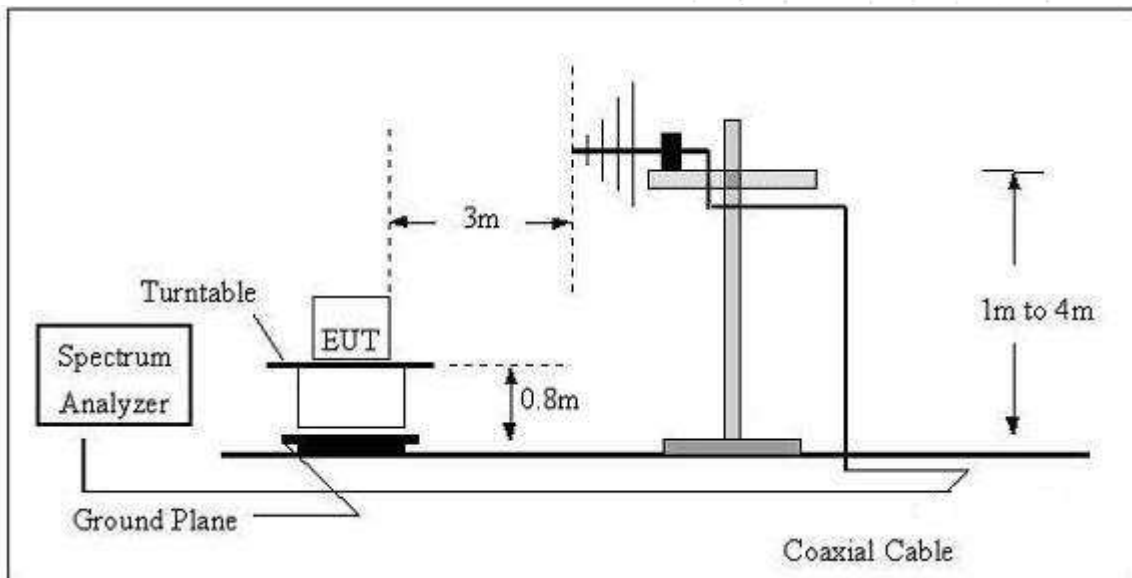

## (C) Radiated Emission Test-Up Frequency Above 1GHz

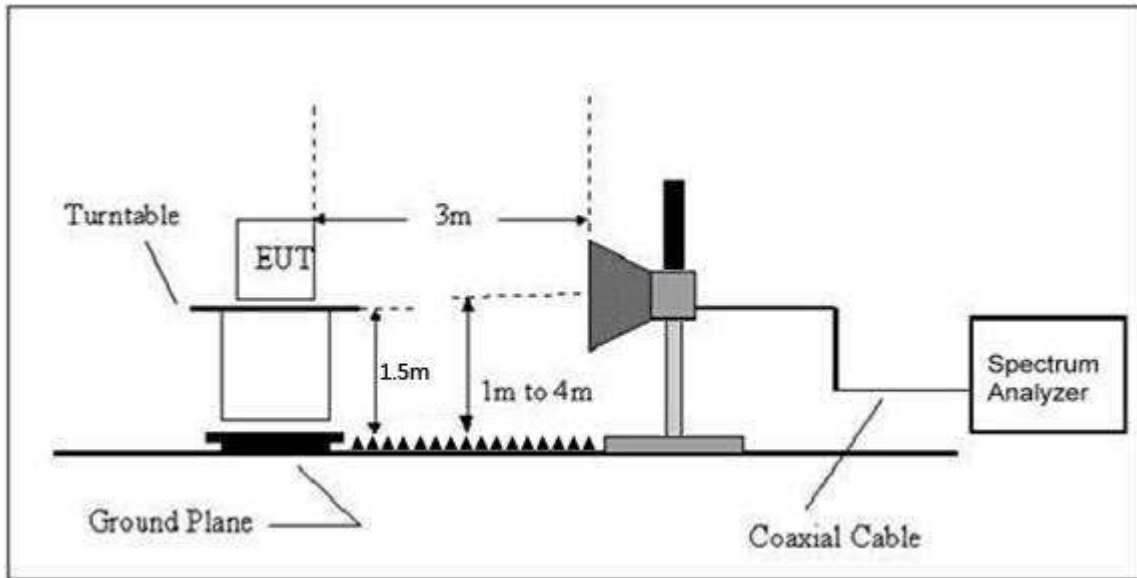
**7.2 Limit**

20dBc in any 100 kHz bandwidth outside the operating frequency band. In case the emission fall within the restricted band specified on 15.205(a), then the 15.209(a) limit in the table below has to be followed.

Frequency (MHz)	Field Strength uV/m	Distance (m)	Field Strength Limit at 3m Distance	
			uV/m	dBuV/m
0.009 ~ 0.490	2400/F(kHz)	300	10000 * 2400/F(kHz)	$20\log^{(2400/F(kHz))} + 80$
0.490 ~ 1.705	24000/F(kHz)	30	100 * 24000/F(kHz)	$20\log^{(24000/F(kHz))} + 40$
1.705 ~ 30	30	30	100 * 30	$20\log^{(30)} + 40$
30 ~ 88	100	3	100	$20\log^{(100)}$
88 ~ 216	150	3	150	$20\log^{(150)}$
216 ~ 960	200	3	200	$20\log^{(200)}$
Above 960	500	3	500	$20\log^{(500)}$

Limits Of Radiated Emission Measurement (Above 1000MHz)

Frequency (MHz)	Limit (dBuV/m) (at 3M)	
	Peak	Average
Above 1000	74	54

Notes:

- (1) The limit for radiated test was performed according to FCC PART 15C.
- (2) The tighter limit applies at the band edges.
- (3) Emission level (dBuV/m) =  $20\log$  Emission level (uV/m).

**Frequency Range Of Radiated Measurement**

(a) For an intentional radiator the spectrum shall be investigated from the lowest radio frequency signal generated in the device, without going below 9 kHz, up to at least the frequency shown in this paragraph:

- (1) If the intentional radiator operates below 10 GHz: to the tenth harmonic of the highest fundamental frequency or to 40 GHz, whichever is lower.
- (2) If the intentional radiator operates at or above 10 GHz and below 30 GHz: to the fifth harmonic of the highest fundamental frequency or to 100 GHz, whichever is lower.
- (3) If the intentional radiator operates at or above 30 GHz: to the fifth harmonic of the highest fundamental frequency or to 200 GHz, whichever is lower, unless specified otherwise elsewhere in the rules.
- (4) If the intentional radiator operates at or above 95 GHz: To the third harmonic of the highest fundamental frequency or to 750 GHz, whichever is lower, unless specified otherwise elsewhere in the rules.
- (5) If the intentional radiator contains a digital device, regardless of whether this digital device controls the functions of the intentional radiator or the digital device is used for additional control or function purposes other than to enable the operation of the intentional radiator, the frequency range shall be investigated up to the range specified in paragraphs (a) (1)through (4) of this section or the range applicable to the digital device, as shown in paragraph (b)(1) of this section, whichever is the higher frequency range of investigation.

**7.3 Test procedure**

Receiver Parameter	Setting
Attenuation	Auto
9kHz~150kHz	RBW 200Hz for QP
150kHz~30MHz	RBW 9kHz for QP
30MHz~1000MHz	RBW 120kHz for QP

Spectrum Parameter	Setting
1-25GHz	RBW 1 MHz /VBW 1 MHz for Peak, RBW 1 MHz / VBW 10Hz for Average

Below 1GHz test procedure as below:

- a. The EUT was placed on the top of a rotating table 0.8 meters above the ground at a 3 meter semi-anechoic chamber. The table was rotated 360 degrees to determine the position of the highest radiation.
- b. The EUT was set 3 meters away from the interference-receiving antenna, which was mounted on the top of a variable-height antenna tower.
- c. The antenna height is varied from one meter to four meters above the ground to determine the maximum value of the field strength. Both horizontal and vertical polarizations of the antenna are set to make the measurement.
- d. For each suspected emission, the EUT was arranged to its worst case and then the antenna was tuned to heights from 1 meter to 4 meters (for the test frequency of below 30MHz, the antenna was tuned to heights 1 meter) and the rotatable table was turned from 0 degrees to 360 degrees to find the maximum reading.
- e. The test-receiver system was set to Peak Detect Function and Specified Bandwidth with Maximum Hold Mode.
- f. If the emission level of the EUT in peak mode was 10dB lower than the limit specified, then testing could be stopped and the peak values of the EUT would be reported. Otherwise the emissions that did not have 10dB margin would be re-tested one by one using peak, quasi-peak or average method as specified and then reported in a data sheet.

Above 1GHz test procedure as below:

- a. The EUT was placed on the top of a rotating table 1.5 meters above the ground at a 3 meter camber. The table was rotated 360 degrees to determine the position of the highest radiation.
- b. The EUT was set 3 meters away from the interference-receiving antenna, which was mounted on the top of a variable-height antenna tower.
- c. The antenna height is varied from one meter to four meters above the ground to determine the maximum value of the field strength. Both horizontal and vertical polarizations of the antenna are set to make the measurement.
- d. For each suspected emission, the EUT was arranged to its worst case and then the antenna was tuned to heights from 1 meter to 4 meters and the rota table was turned from 0 degrees to 360 degrees to find the maximum reading.
- e. The test-receiver system was set to Peak Detect Function and Specified Bandwidth with Maximum Hold Mode.
- f. If the emission level of the EUT in peak mode was 10dB lower than the limit specified, then testing could be stopped and the peak values of the EUT would be reported. Otherwise the emissions that did not have 10dB margin would be re-tested one by one using peak, quasi-peak or average method as specified and then reported in a data sheet.
- g. Test the EUT in the lowest channel, the middlest channel, the Highest channel.

Note:

Both horizontal and vertical antenna polarities were tested and performed pretest to three orthogonal axis. The worst case emissions were reported.

## 7.4 EUT operating Conditions

The EUT was configured for testing in a typical fashion (as a customer would normally use it). The EUT has been programmed to continuously transmit during test. This operating condition was tested and used to collect the included data.

## 7.5 Test Result

Below 30MHz

Temperature:	26 °C	Relative Humidity:	54%
Pressure:	101KPa	Test Voltage:	DC 3.7V
Test Mode:	Mode 4		

Freq.	Reading	Limit	Margin	State
(MHz)	(dBuV/m)	(dBuV/m)	(dB)	P/F
--	--	--	--	PASS
--	--	--	--	PASS

Note:

The amplitude of spurious emissions which are attenuated by more than 20dB below the permissible value has no need to be reported.

Distance extrapolation factor =  $40 \log(\text{specific distance/test distance})(\text{dB})$ ;

Limit line = specific limits(dBuV) + distance extrapolation factor.



**Between 30MHz – 1GHz**

Temperature:	26 °C	Relative Humidity:	54%
Pressure:	101KPa	Test Voltage:	DC 3.7V
Test Mode:	Mode 4	Polarization:	Horizontal

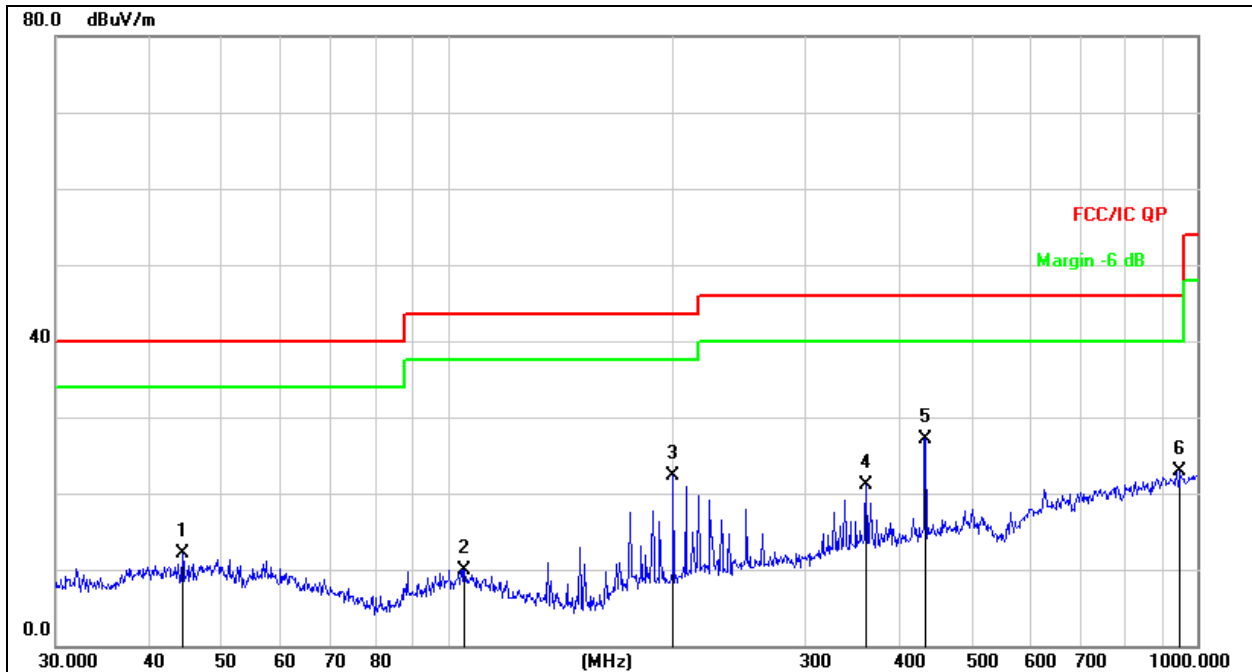
**Remark:**

- Factor = Antenna Factor + Cable Loss – Pre-amplifier.
- Measurement = Reading Level + Correct Factor
- Over = Measurement - Limit

No.	Mk.	Freq. MHz	Reading Level dBuV	Correct Factor dB	Measure- ment dBuV/m	Limit dB/m	Over dB	Detector
1		44.2751	26.53	-14.37	12.16	40.00	-27.84	QP
2		105.2716	26.22	-16.30	9.92	43.50	-33.58	QP
3		199.9856	37.93	-15.72	22.21	43.50	-21.29	QP
4		361.7139	32.40	-11.33	21.07	46.00	-24.93	QP
5	*	434.0649	37.28	-10.17	27.11	46.00	-18.89	QP
6		948.7608	25.85	-2.94	22.91	46.00	-23.09	QP

Temperature:	26 °C	Relative Humidity:	54%
Pressure:	101KPa	Test Voltage:	DC 3.7V
Test Mode:	Mode 4	Polarization:	Vertical

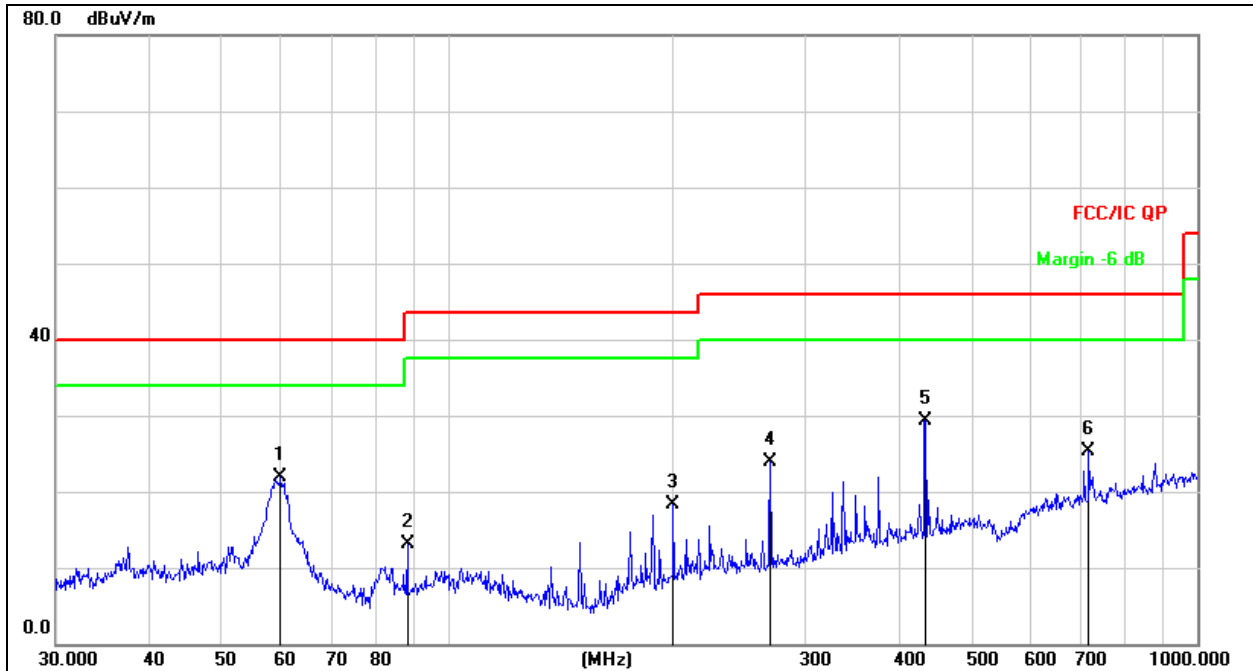
**Remark:**

- Factor = Antenna Factor + Cable Loss – Pre-amplifier.
- Measurement = Reading Level + Correct Factor
- Over = Measurement - Limit

No.	Mk.	Freq. MHz	Reading Level dBuV	Correct Factor dB	Measure- ment dBuV/m	Limit dB/m	Over dB	Detector
1		59.8588	37.06	-15.23	21.83	40.00	-18.17	QP
2		88.3421	30.90	-17.79	13.11	43.50	-30.39	QP
3		199.9856	33.98	-15.72	18.26	43.50	-25.24	QP
4		269.4284	37.86	-13.88	23.98	46.00	-22.02	QP
5	*	434.0649	39.55	-10.17	29.38	46.00	-16.62	QP
6		716.6820	30.71	-5.47	25.24	46.00	-20.76	QP



**Between 1GHz – 25GHz**

Polar (H/V)	Frequency	Reading Level	Correct Factor	Measure- ment	Limits	Over	Detector Type
	(MHz)	(dBuV/m)	(dB)	(dBuV/m)	(dBuV/ m)	(dB)	
<b>GFSK Low channel</b>							
V	4804.00	71.50	-19.99	51.51	74.00	-22.49	PK
V	4804.00	61.00	-19.99	41.01	54.00	-12.99	AV
V	7206.00	61.15	-14.22	46.93	74.00	-27.07	PK
V	7206.00	51.00	-14.22	36.78	54.00	-17.22	AV
H	4804.00	69.54	-19.99	49.55	74.00	-24.45	PK
H	4804.00	60.31	-19.99	40.32	54.00	-13.68	AV
H	7206.00	58.82	-14.22	44.60	74.00	-29.40	PK
H	7206.00	50.18	-14.22	35.96	54.00	-18.04	AV
<b>GFSK Middle channel</b>							
V	4882.00	69.83	-19.84	49.99	74.00	-24.01	PK
V	4882.00	63.16	-19.84	43.32	54.00	-10.68	AV
V	7323.00	61.31	-13.90	47.41	74.00	-26.59	PK
V	7323.00	52.78	-13.90	38.88	54.00	-15.12	AV
H	4882.00	66.34	-19.84	46.50	74.00	-27.50	PK
H	4882.00	57.04	-19.84	37.20	54.00	-16.80	AV
H	7323.00	59.42	-13.90	45.52	74.00	-28.48	PK
H	7323.00	51.92	-13.90	38.02	54.00	-15.98	AV
<b>GFSK High channel</b>							
V	4960.00	71.21	-19.68	51.53	74.00	-22.47	PK
V	4960.00	60.77	-19.68	41.09	54.00	-12.91	AV
V	7440.00	62.21	-13.57	48.64	74.00	-25.36	PK
V	7440.00	51.30	-13.57	37.73	54.00	-16.27	AV
H	4960.00	69.89	-19.68	50.21	74.00	-23.79	PK
H	4960.00	60.65	-19.68	40.97	54.00	-13.03	AV
H	7440.00	60.25	-13.57	46.68	74.00	-27.32	PK
H	7440.00	52.19	-13.57	38.62	54.00	-15.38	AV

**Remark:**

1. Measurement = Reading Level + Correct Factor, Correct Factor = Antenna Factor + Cable Loss – Pre-amplifier. Over= Measurement - Limit
2. If peak below the average limit, the average emission was no test.
3. In restricted bands of operation, The spurious emissions below the permissible value more than 20Db
4. The amplitude of spurious emissions which are attenuated by more than 20dB below the permissible value has no need to be reported.



Polar (H/V)	Frequency	Reading Level	Correct Factor	Measure- ment	Limits	Over	Detector Type
	(MHz)	(dBuV/m)	(dB)	(dBuV/m)	(dBuV/ m)	(dB)	
<b><math>\pi/4</math> DQPSK Low channel</b>							
V	4804.00	70.46	-19.99	50.47	74.00	-23.53	PK
V	4804.00	60.75	-19.99	40.76	54.00	-13.24	AV
V	7206.00	62.21	-14.22	47.99	74.00	-26.01	PK
V	7206.00	53.11	-14.22	38.89	54.00	-15.11	AV
H	4804.00	67.99	-19.99	48.00	74.00	-26.00	PK
H	4804.00	58.99	-19.99	39.00	54.00	-15.00	AV
H	7206.00	60.64	-14.22	46.42	74.00	-27.58	PK
H	7206.00	52.21	-14.22	37.99	54.00	-16.01	AV
<b><math>\pi/4</math> DQPSK Middle channel</b>							
V	4882.00	69.20	-19.84	49.36	74.00	-24.64	PK
V	4882.00	62.00	-19.84	42.16	54.00	-11.84	AV
V	7323.00	58.21	-13.90	44.31	74.00	-29.69	PK
V	7323.00	48.49	-13.90	34.59	54.00	-19.41	AV
H	4882.00	67.88	-19.84	48.04	74.00	-25.96	PK
H	4882.00	57.54	-19.84	37.70	54.00	-16.30	AV
H	7323.00	57.16	-13.90	43.26	74.00	-30.74	PK
H	7323.00	48.82	-13.90	34.92	54.00	-19.08	AV
<b><math>\pi/4</math> DQPSK High channel</b>							
V	4960.00	70.90	-19.68	51.22	74.00	-22.78	PK
V	4960.00	62.03	-19.68	42.35	54.00	-11.65	AV
V	7440.00	63.64	-13.57	50.07	74.00	-23.93	PK
V	7440.00	52.82	-13.57	39.25	54.00	-14.75	AV
H	4960.00	68.77	-19.68	49.09	74.00	-24.91	PK
H	4960.00	58.00	-19.68	38.32	54.00	-15.68	AV
H	7440.00	61.66	-13.57	48.09	74.00	-25.91	PK
H	7440.00	52.94	-13.57	39.37	54.00	-14.63	AV

**Remark:**

1. Measurement = Reading Level + Correct Factor, Correct Factor = Antenna Factor + Cable Loss – Pre-amplifier. Over= Measurement - Limit
2. If peak below the average limit, the average emission was no test.
3. In restricted bands of operation, The spurious emissions below the permissible value more than 20dB
4. The amplitude of spurious emissions which are attenuated by more than 20dB below the permissible value has no need to be reported.

Polar (H/V)	Frequency	Reading Level	Correct Factor	Measure- ment	Limits	Over	Detector Type
	(MHz)	(dBuV/m)	(dB)	(dBuV/m)	(dBuV/ m)	(dB)	
<b>8DPSK Low channel</b>							
V	4804.00	70.77	-19.99	50.78	74.00	-23.22	PK
V	4804.00	60.50	-19.99	40.51	54.00	-13.49	AV
V	7206.00	63.22	-14.22	49.00	74.00	-25.00	PK
V	7206.00	53.35	-14.22	39.13	54.00	-14.87	AV
H	4804.00	68.92	-19.99	48.93	74.00	-25.07	PK
H	4804.00	58.74	-19.99	38.75	54.00	-15.25	AV
H	7206.00	62.03	-14.22	47.81	74.00	-26.19	PK
H	7206.00	54.56	-14.22	40.34	54.00	-13.66	AV
<b>8DPSK Middle channel</b>							
V	4882.00	68.45	-19.84	48.61	74.00	-25.39	PK
V	4882.00	61.26	-19.84	41.42	54.00	-12.58	AV
V	7323.00	58.49	-13.90	44.59	74.00	-29.41	PK
V	7323.00	49.85	-13.90	35.95	54.00	-18.05	AV
H	4882.00	66.29	-19.84	46.45	74.00	-27.55	PK
H	4882.00	55.35	-19.84	35.51	54.00	-18.49	AV
H	7323.00	57.17	-13.90	43.27	74.00	-30.73	PK
H	7323.00	48.37	-13.90	34.47	54.00	-19.53	AV
<b>8DPSK High channel</b>							
V	4960.00	70.07	-19.68	50.39	74.00	-23.61	PK
V	4960.00	60.85	-19.68	41.17	54.00	-12.83	AV
V	7440.00	63.77	-13.57	50.20	74.00	-23.80	PK
V	7440.00	54.50	-13.57	40.93	54.00	-13.07	AV
H	4960.00	67.11	-19.68	47.43	74.00	-26.57	PK
H	4960.00	57.58	-19.68	37.90	54.00	-16.10	AV
H	7440.00	62.06	-13.57	48.49	74.00	-25.51	PK
H	7440.00	54.27	-13.57	40.70	54.00	-13.30	AV

**Remark:**

1. Measurement = Reading Level + Correct Factor, Correct Factor = Antenna Factor + Cable Loss – Pre-amplifier. Over= Measurement - Limit
2. If peak below the average limit, the average emission was no test.
3. In restricted bands of operation, The spurious emissions below the permissible value more than 20dB
4. The amplitude of spurious emissions which are attenuated by more than 20dB below the permissible value has no need to be reported.

## 8. Radiated Band Emission Measurement And Restricted Bands Of Operation

### 8.1 Block Diagram Of Test Setup

Radiated Emission Test-Up Frequency Above 1GHz

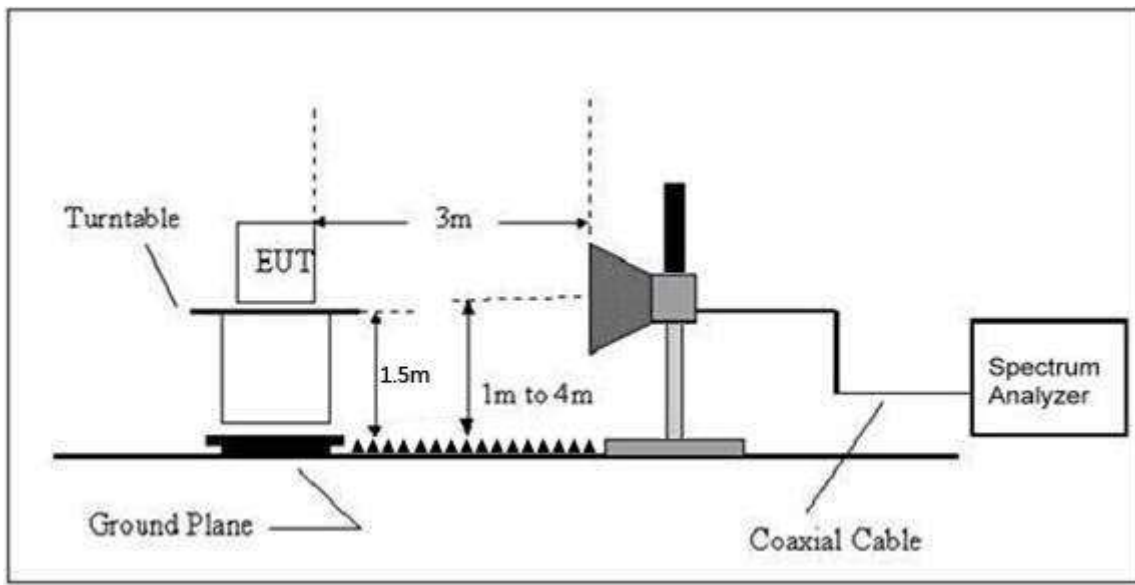

### 8.2 Limit

FCC Part15 C Section 15.209 and 15.205

(a) Except as shown in paragraph (d) of this section, only spurious emissions are permitted in any of the frequency bands listed below:

MHz	MHz	MHz	GHz
0.090-0.110	16.42-16.423	399.9-410	4.5-5.15
0.495-0.505	16.69475-16.69525	608-614	5.35-5.46
2.1735-2.1905	16.80425-16.80475	960-1240	7.25-7.75
4.125-4.128	25.5-25.67	1300-1427	8.025-8.5
4.17725-4.17775	37.5-38.25	1435-1626.5	9.0-9.2
4.20725-4.20775	73-74.6	1645.5-1646.5	9.3-9.5
6.215-6.218	74.8-75.2	1660-1710	10.6-12.7
6.26775-6.26825	108-121.94	1718.8-1722.2	13.25-13.4
6.31175-6.31225	123-138	2200-2300	14.47-14.5
8.291-8.294	149.9-150.05	2310-2390	15.35-16.2
8.362-8.366	156.52475-156.52525	2483.5-2500	17.7-21.4
8.37625-8.38675	156.7-156.9	2690-2900	22.01-23.12
8.41425-8.41475	162.0125-167.17	3260-3267	23.6-24.0
12.29-12.293	167.72-173.2	3332-3339	31.2-31.8
12.51975-12.52025	240-285	3345.8-3358	36.43-36.5
12.57675-12.57725	322-335.4	3600-4400	( <sup>2</sup> )
13.36-13.41			

## Limits Of Radiated Emission Measurement (Above 1000MHz)

Frequency (MHz)	Limit (dBuV/m) (at 3M)	
	Peak	Average
Above 1000	74	54

## Notes:

- (1)The limit for radiated test was performed according to FCC PART 15C.
- (2)The tighter limit applies at the band edges.
- (3)Emission level (dBuV/m)=20log Emission level (uV/m).

### 8.3 Test procedure

Receiver Parameter	Setting
Attenuation	Auto
Start Frequency	2300MHz
Stop Frequency	2520
RB / VB (Emission In Restricted Band)	1 MHz / 1 MHz for Peak, 1 MHz / 10Hz for Average

Above 1GHz test procedure as below:

- a.The EUT was placed on the top of a rotating table 1.5 meters above the ground at a 3 meter camber. The table was rotated 360 degrees to determine the position of the highest radiation.
- b.The EUT was set 3 meters away from the interference-receiving antenna, which was mounted on the top of a variable-height antenna tower.
- c.The antenna height is varied from one meter to four meters above the ground to determine the maximum value of the field strength. Both horizontal and vertical polarizations of the antenna are set to make the measurement.
- d.For each suspected emission, the EUT was arranged to its worst case and then the antenna was tuned to heights from 1 meter to 4 meters and the rota table was turned from 0 degrees to 360 degrees to find the maximum reading.
- e.The test-receiver system was set to Peak Detect Function and Specified Bandwidth with Maximum Hold Mode.
- f. If the emission level of the EUT in peak mode was 10dB lower than the limit specified, then testing could be stopped and the peak values of the EUT would be reported. Otherwise the emissions that did not have 10dB margin would be re-tested one by one using peak, quasi-peak or average method as specified and then reported in a data sheet.
- g. Test the EUT in the lowest channel, the Highest channel.

## Note:

Both horizontal and vertical antenna polarities were tested and performed pretest to three orthogonal axis. The worst case emissions were reported.

### 8.4 EUT operating Conditions

The EUT was configured for testing in a typical fashion (as a customer would normally use it). The EUT has been programmed to continuously transmit during test. This operating condition was tested and used to collect the included data.



## 8.5 Test Result

Test mode	Polar (H/V)	Frequency (MHz)	Reading Level (dBuV/m)	Correct Factor (dB)	Measurement (dBuV/m)	Limits (dBuV/m)		Over	Result	
					PK	PK	AV	PK		
GFSK	<b>Low Channel 2402MHz</b>									
	H	2390.00	72.43	-25.43	47.00	74.00	54.00	-27.00	PASS	
	H	2400.00	74.18	-25.40	48.78	74.00	54.00	-25.22	PASS	
	V	2390.00	73.38	-25.43	47.95	74.00	54.00	-26.05	PASS	
	V	2400.00	73.18	-25.40	47.78	74.00	54.00	-26.22	PASS	
	<b>High Channel 2480MHz</b>									
	H	2483.50	70.49	-25.15	45.34	74.00	54.00	-28.66	PASS	
	H	2500.00	68.09	-25.10	42.99	74.00	54.00	-31.01	PASS	
	V	2483.50	71.83	-25.15	46.68	74.00	54.00	-27.32	PASS	
	V	2500.00	67.47	-25.10	42.37	74.00	54.00	-31.63	PASS	
	π/4QPSK	<b>Low Channel 2402MHz</b>								
		H	2390.00	72.77	-25.43	47.34	74.00	54.00	-26.66	PASS
H		2400.00	74.45	-25.40	49.05	74.00	54.00	-24.95	PASS	
V		2390.00	72.58	-25.43	47.15	74.00	54.00	-26.85	PASS	
V		2400.00	72.96	-25.40	47.56	74.00	54.00	-26.44	PASS	
<b>High Channel 2480MHz</b>										
H		2483.50	73.13	-25.15	47.98	74.00	54.00	-26.02	PASS	
H		2500.00	69.35	-25.10	44.25	74.00	54.00	-29.75	PASS	
V		2483.50	72.28	-25.15	47.13	74.00	54.00	-26.87	PASS	
V		2500.00	67.74	-25.10	42.64	74.00	54.00	-31.36	PASS	
8DPSK		<b>Low Channel 2402MHz</b>								
		H	2390.00	73.77	-25.43	48.34	74.00	54.00	-25.66	PASS
	H	2400.00	75.08	-25.40	49.68	74.00	54.00	-24.32	PASS	
	V	2390.00	74.04	-25.43	48.61	74.00	54.00	-25.39	PASS	
	V	2400.00	75.71	-25.40	50.31	74.00	54.00	-23.69	PASS	
	<b>High Channel 2480MHz</b>									
	H	2483.50	73.61	-25.15	48.46	74.00	54.00	-25.54	PASS	
	H	2500.00	68.94	-25.10	43.84	74.00	54.00	-30.16	PASS	
	V	2483.50	73.90	-25.15	48.75	74.00	54.00	-25.25	PASS	
	V	2500.00	70.09	-25.10	44.99	74.00	54.00	-29.01	PASS	

**Remark:**

1. Measurement = Reading Level + Correct Factor, Correct Factor = Antenna Factor + Cable Loss – Pre-amplifier.
2. If the PK measured levels comply with average limit, then the average level were deemed to comply with average limit.
3. In restricted bands of operation, The spurious emissions below the permissible value more than 20dB
4. The amplitude of spurious emissions which are attenuated by more than 20dB below the permissible value has no need to be reported.



## 9. Spurious RF Conducted Emissions

### 9.1 Block Diagram Of Test Setup

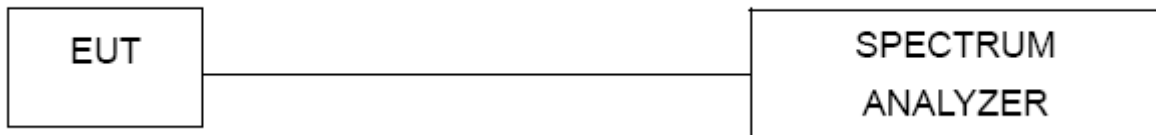

### 9.2 Limit

Regulation 15.247 (d), In any 100 kHz bandwidth outside the frequency band in which the spread spectrum or digitally modulated intentional radiator is operating, the radio frequency power that is produced by the intentional radiator shall be at least 20 dB below that in the 100 kHz bandwidth within the band that contains the highest level of the desired power, based on either an RF conducted or a radiated measurement, provided the transmitter demonstrates compliance with the peak conducted power limits. If the transmitter complies with the conducted power limits based on the use of RMS averaging over a time interval, as permitted under paragraph (b)(3) of this section, the attenuation required under this paragraph shall be 30 dB instead of 20 dB. Attenuation below the general limits specified in §15.209(a) is not required. In addition, radiated emissions which fall in the restricted bands, as defined in §15.205(a), must also comply with the radiated emission limits specified in §15.209(a) (see §15.205(c))

### 9.3 Test procedure

1. Remove the antenna from the EUT and then connect a low RF cable from the antenna port to the spectrum;
2. Set the spectrum analyzer:  
RBW = 100kHz, VBW = 300kHz, Sweep = auto  
Detector function = peak, Trace = max hold

## 9.4 Test Result

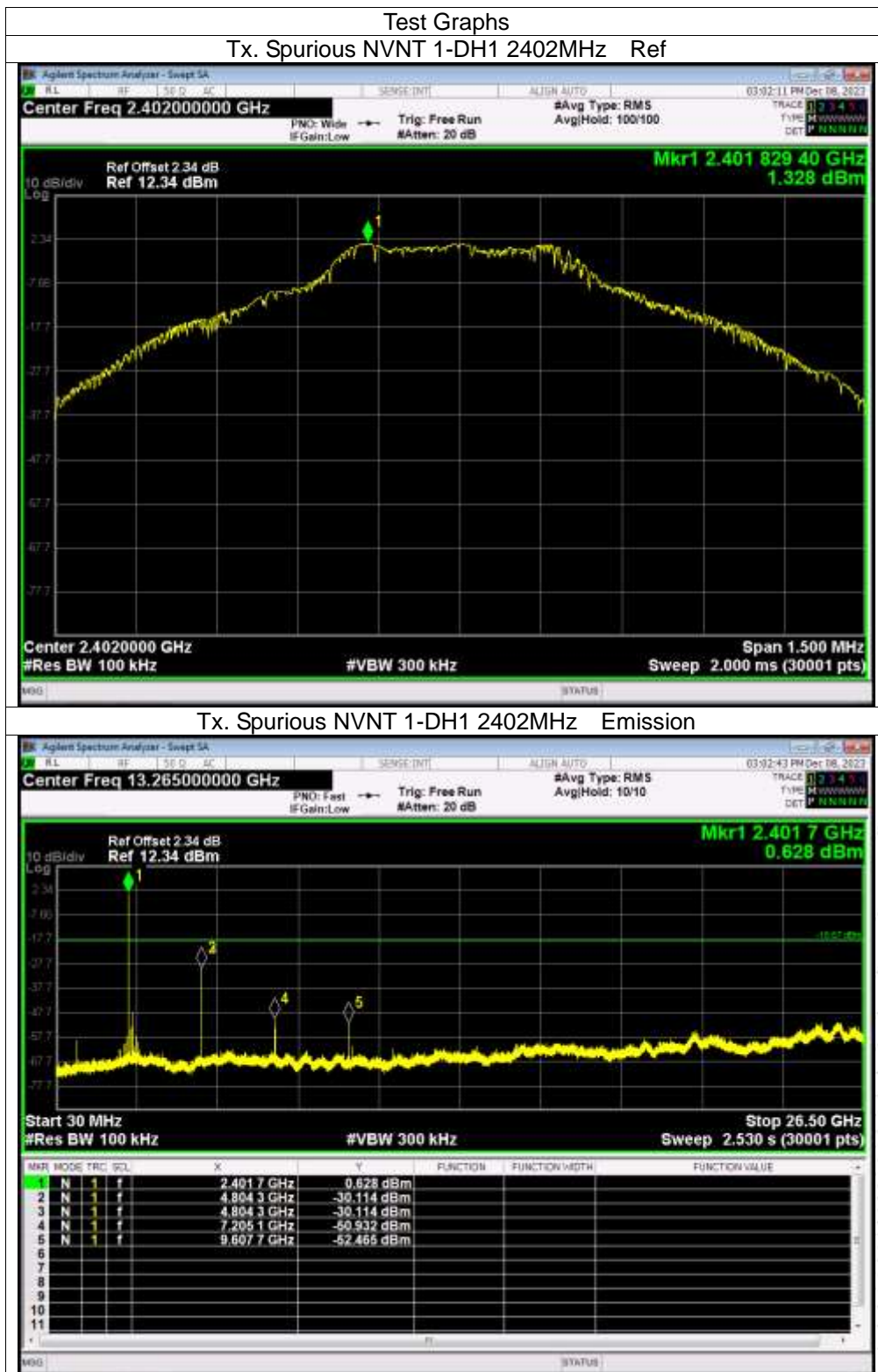



Tx. Spurious NVNT 1-DH1 2441MHz Ref



Tx. Spurious NVNT 1-DH1 2441MHz Emission

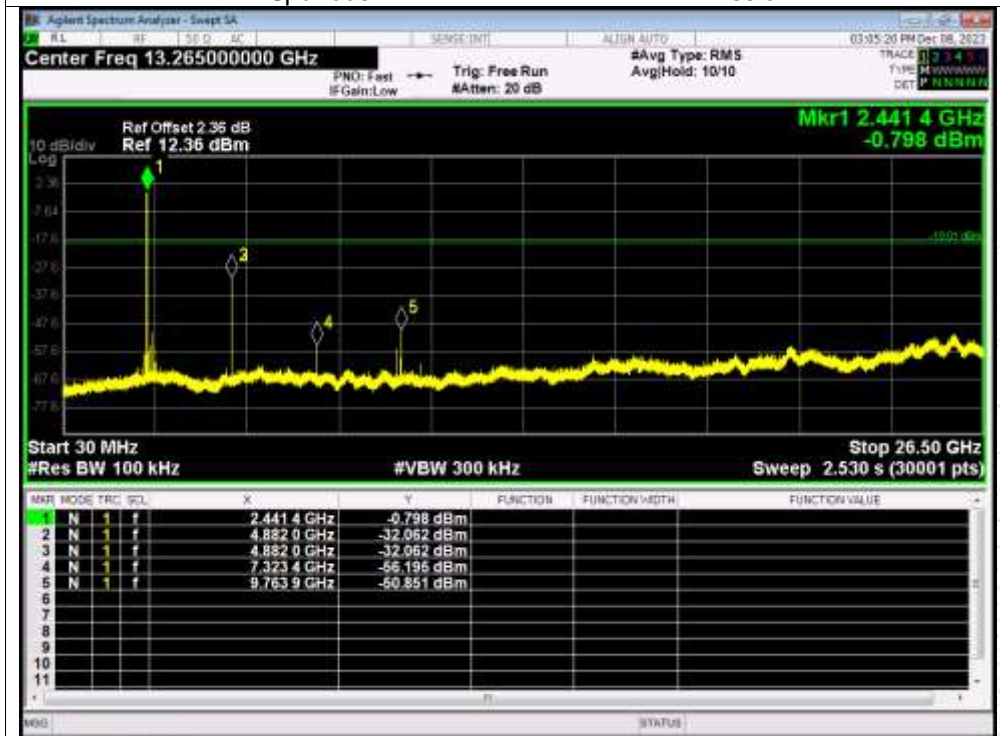

CO.LTD

Tx. Spurious NVNT 1-DH1 2480MHz Ref



Tx. Spurious NVNT 1-DH1 2480MHz Emission

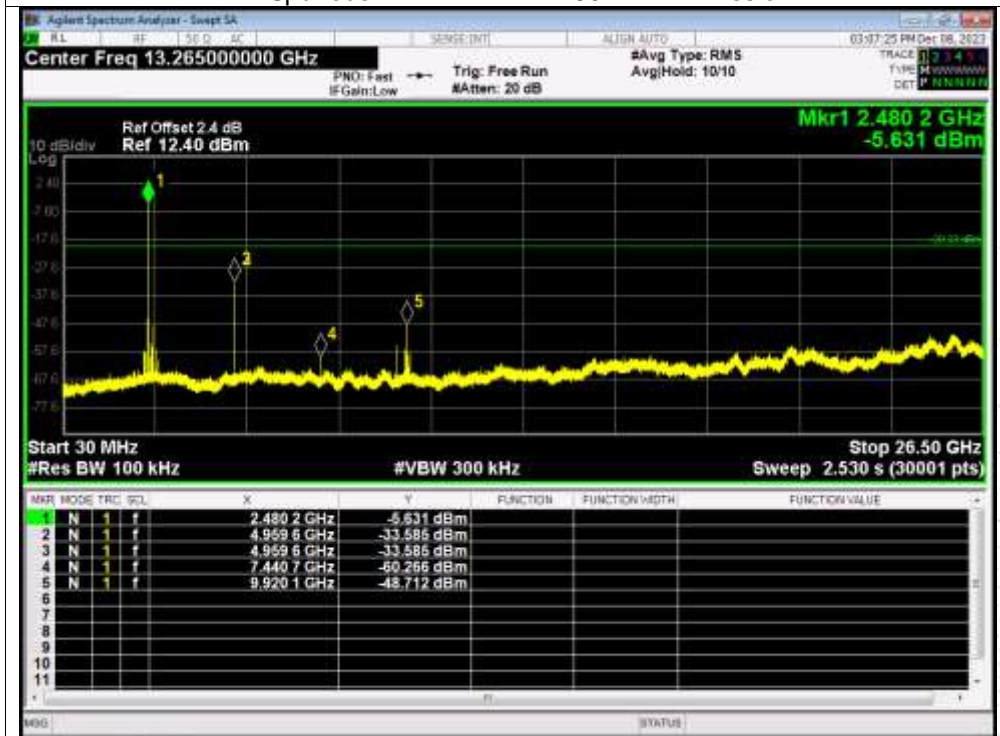

SHENZHEN

Tx. Spurious NVNT 2-DH1 2402MHz Ref



Tx. Spurious NVNT 2-DH1 2402MHz Emission

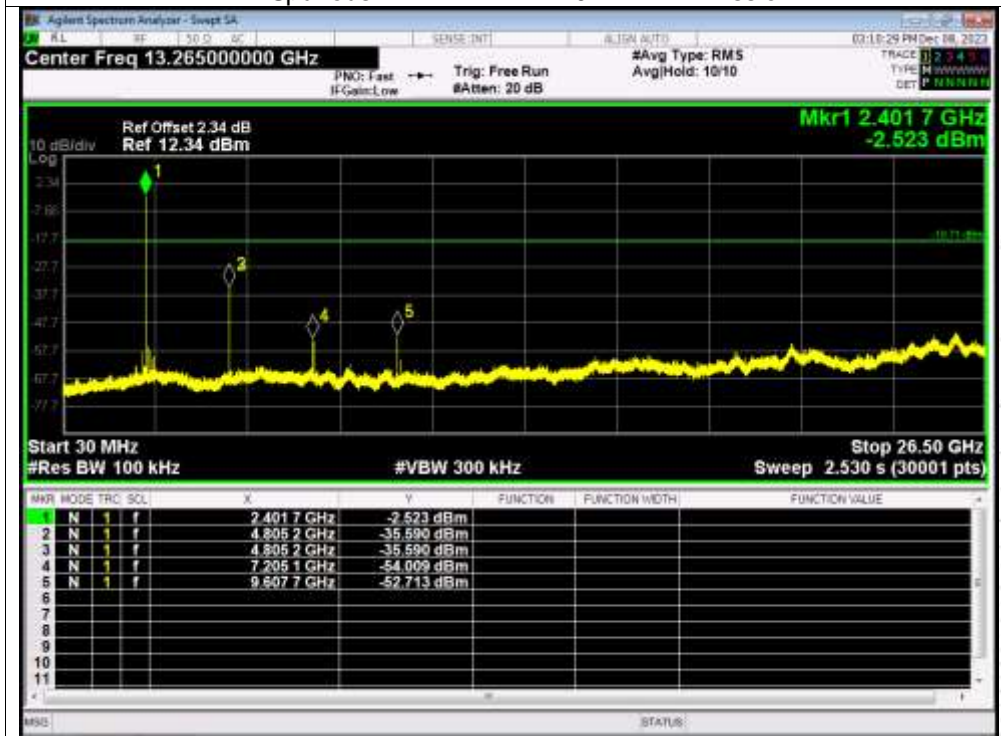

Tx. Spurious NVNT 2-DH1 2441MHz Ref



Tx. Spurious NVNT 2-DH1 2441MHz Emission

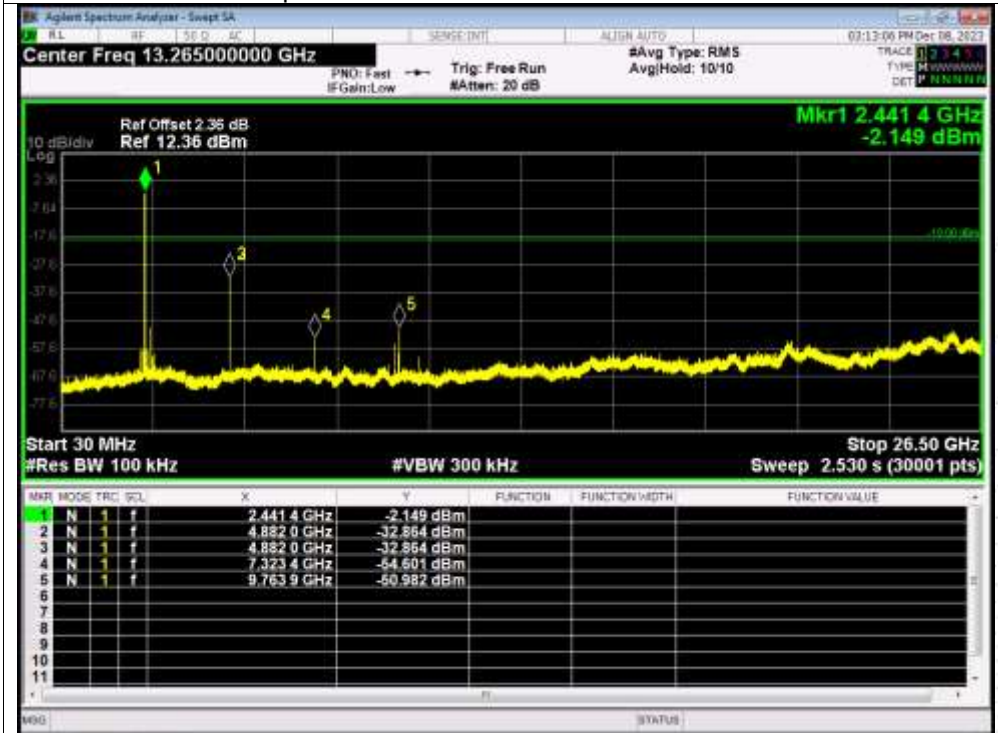



Tx. Spurious NVNT 2-DH1 2480MHz Ref



Tx. Spurious NVNT 2-DH1 2480MHz Emission

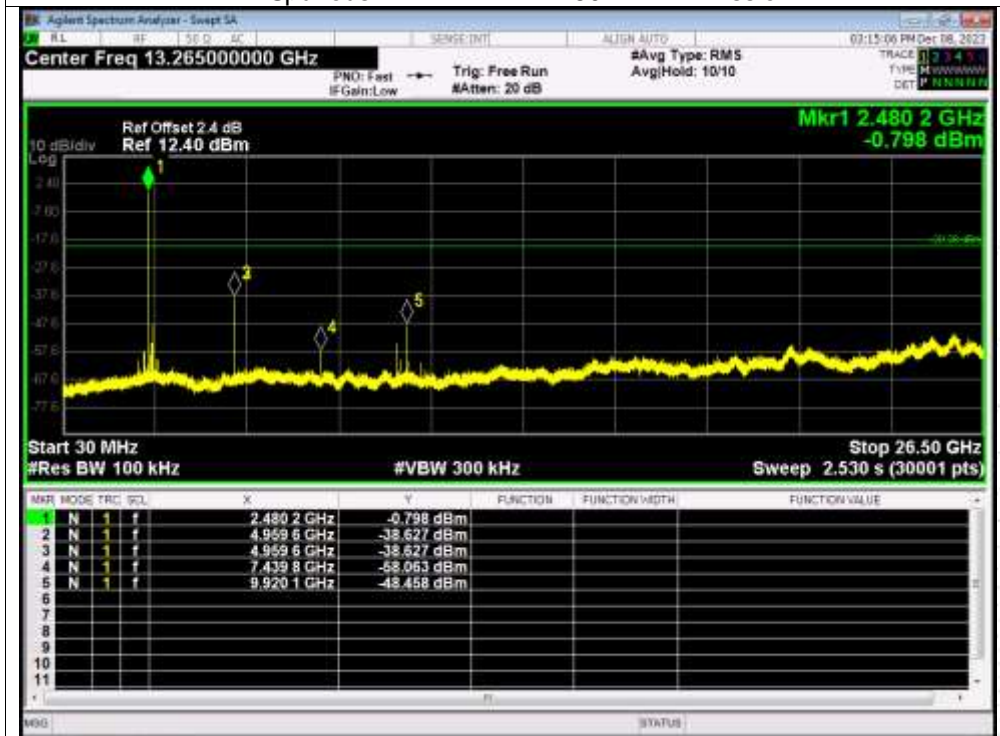

Tx. Spurious NVNT 3-DH1 2402MHz Ref



Tx. Spurious NVNT 3-DH1 2402MHz Emission

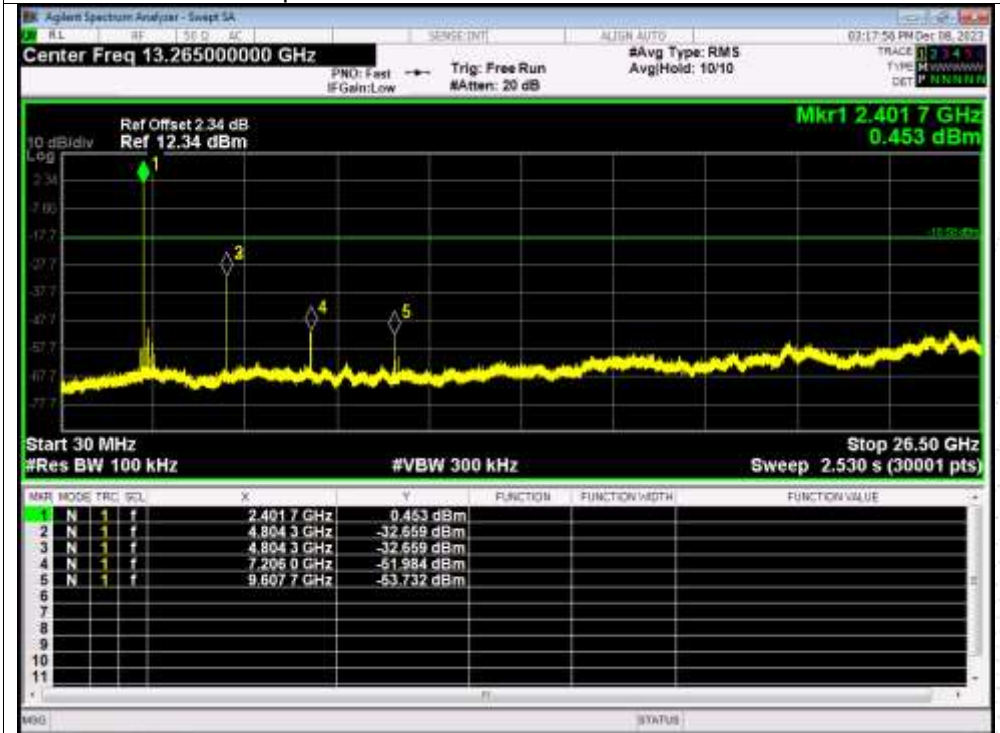

Tx. Spurious NVNT 3-DH1 2441MHz Ref



Tx. Spurious NVNT 3-DH1 2441MHz Emission

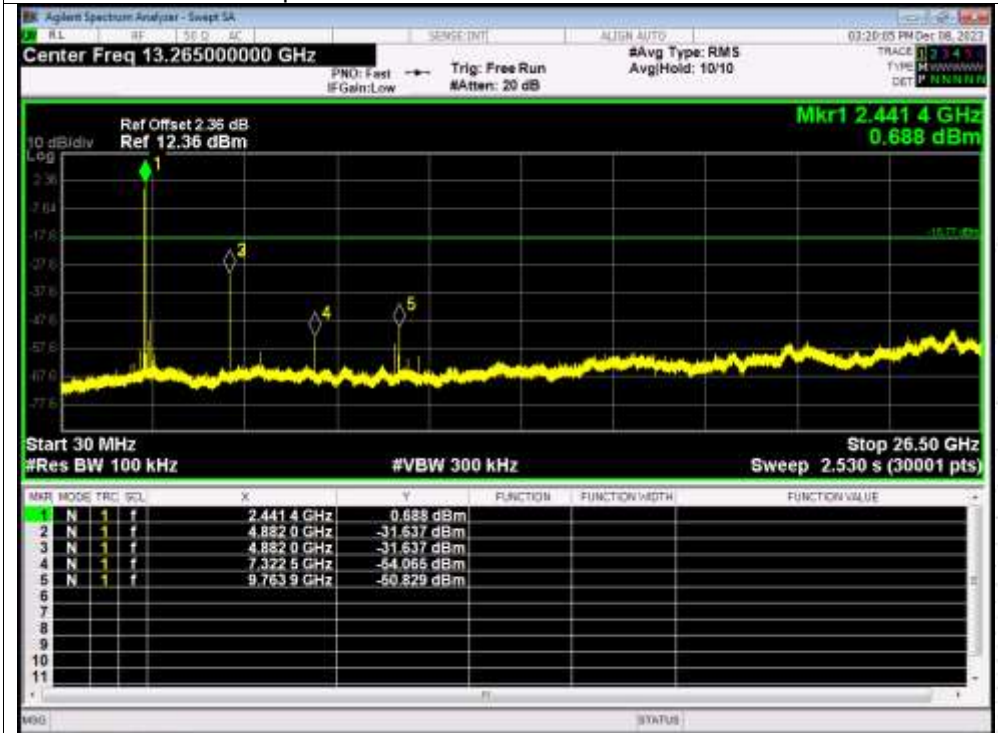

CO., LTD



Tx. Spurious NVNT 3-DH1 2480MHz Ref



Tx. Spurious NVNT 3-DH1 2480MHz Emission

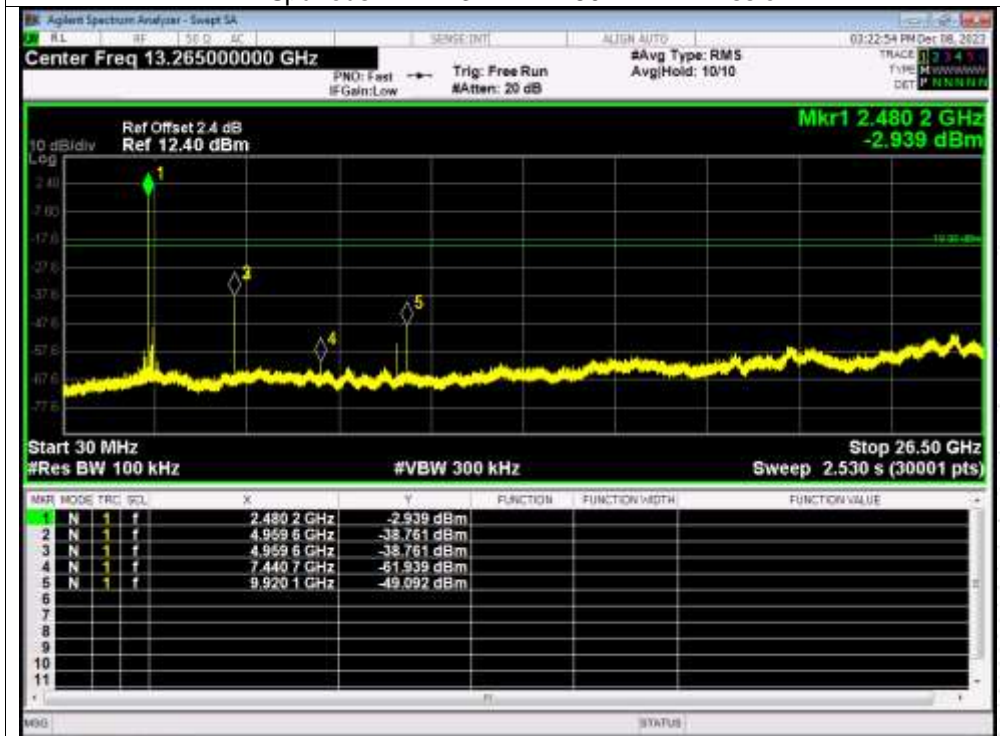

SHENZHEN

## Test Graphs

Band Edge NVNT 1-DH1 2402MHz No-Hopping Ref

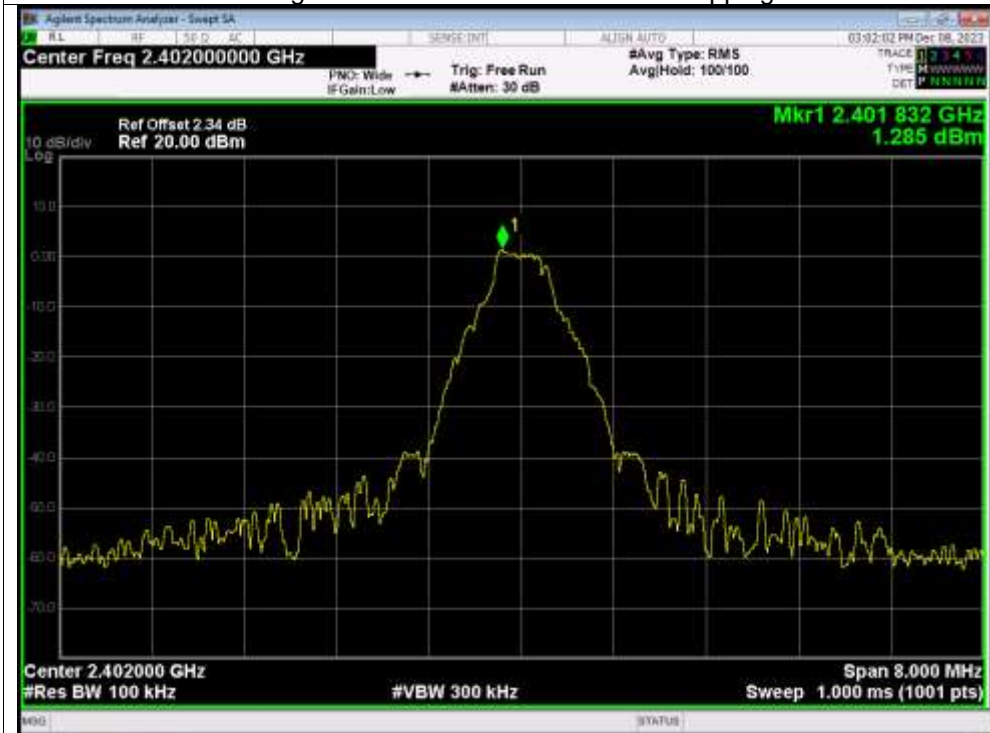

Band Edge NVNT 1-DH1 2402MHz No-Hopping Emission

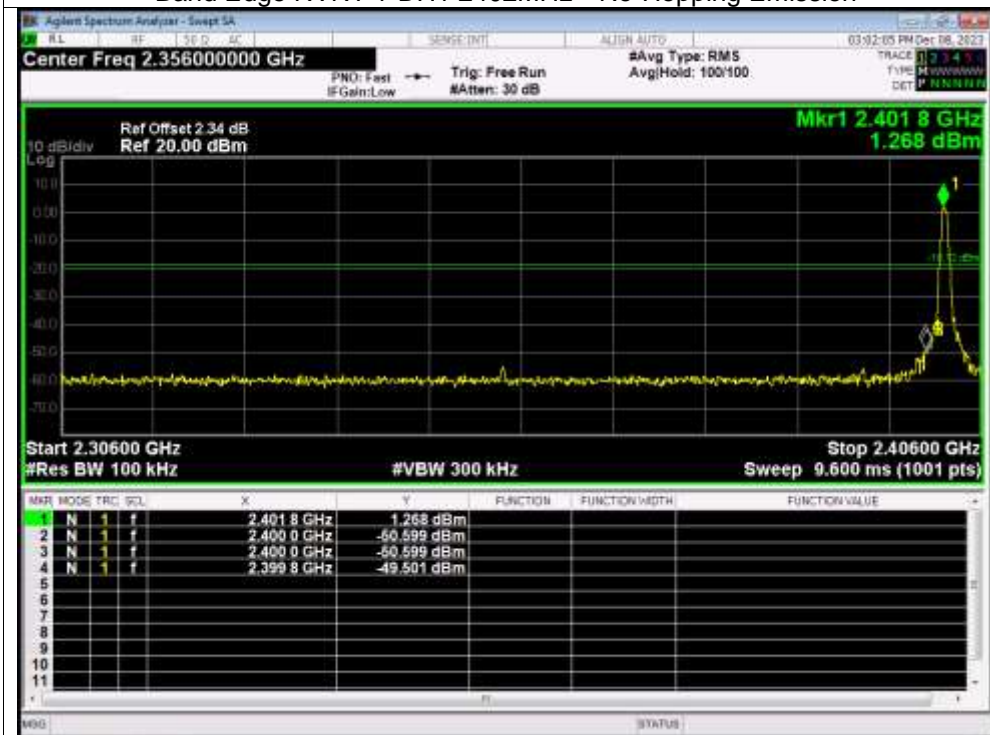

Band Edge NVNT 1-DH1 2480MHz No-Hopping Ref



Band Edge NVNT 1-DH1 2480MHz No-Hopping Emission

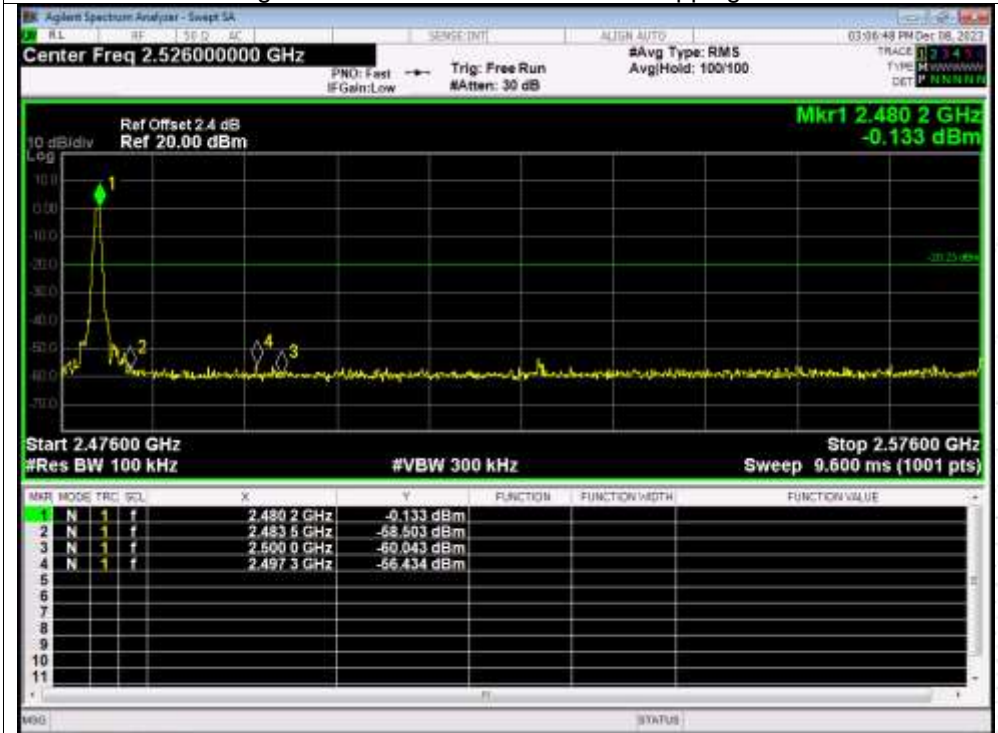

Band Edge NVNT 2-DH1 2402MHz No-Hopping Ref

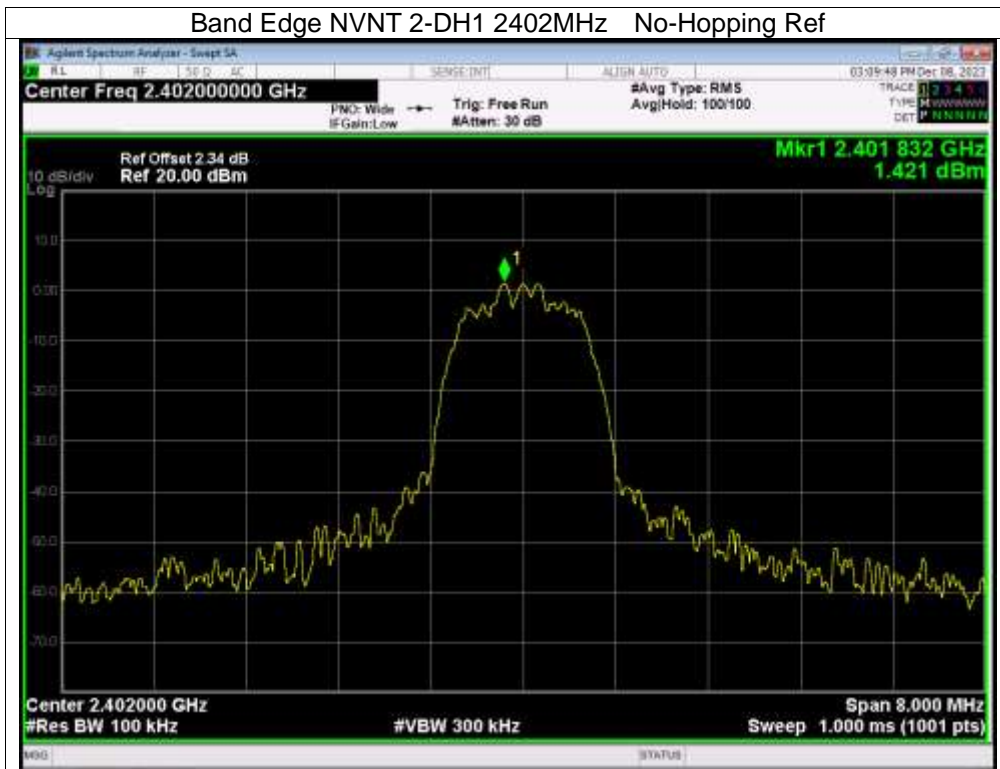

Band Edge NVNT 2-DH1 2402MHz No-Hopping Emission

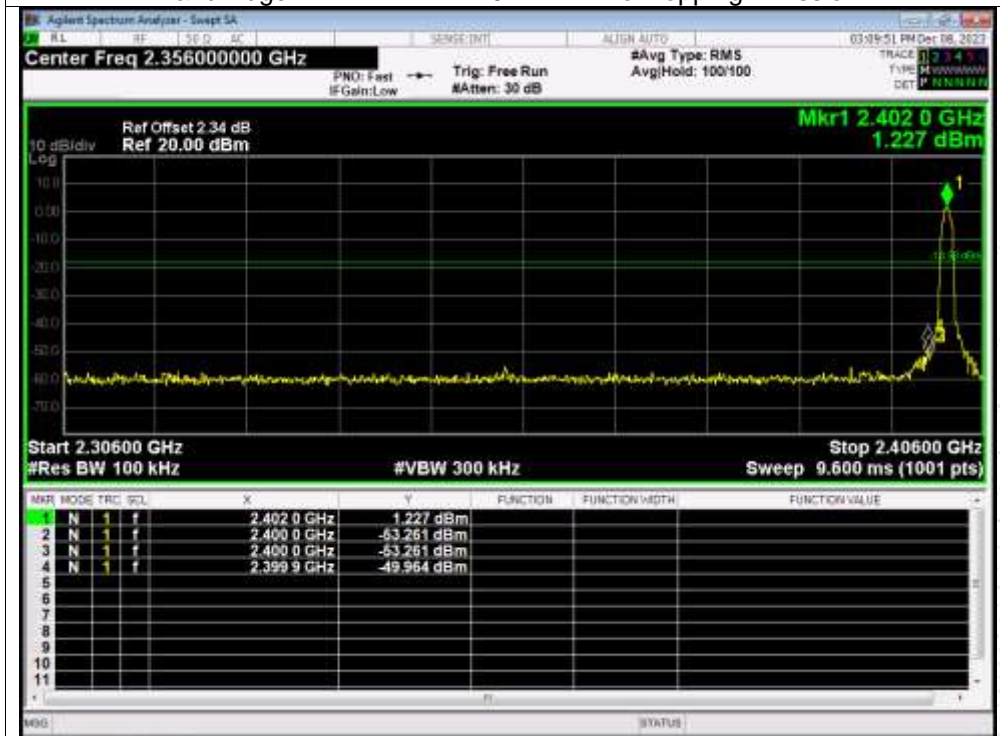



Band Edge NVNT 2-DH1 2480MHz No-Hopping Ref



Band Edge NVNT 2-DH1 2480MHz No-Hopping Emission

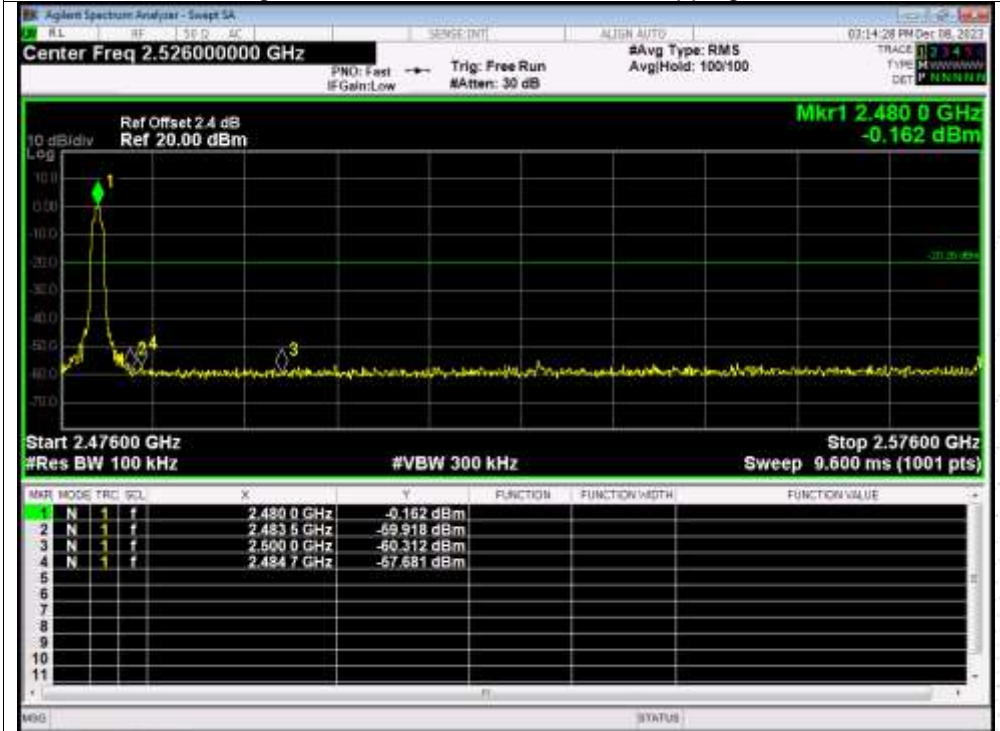

Band Edge NVNT 3-DH1 2402MHz No-Hopping Ref

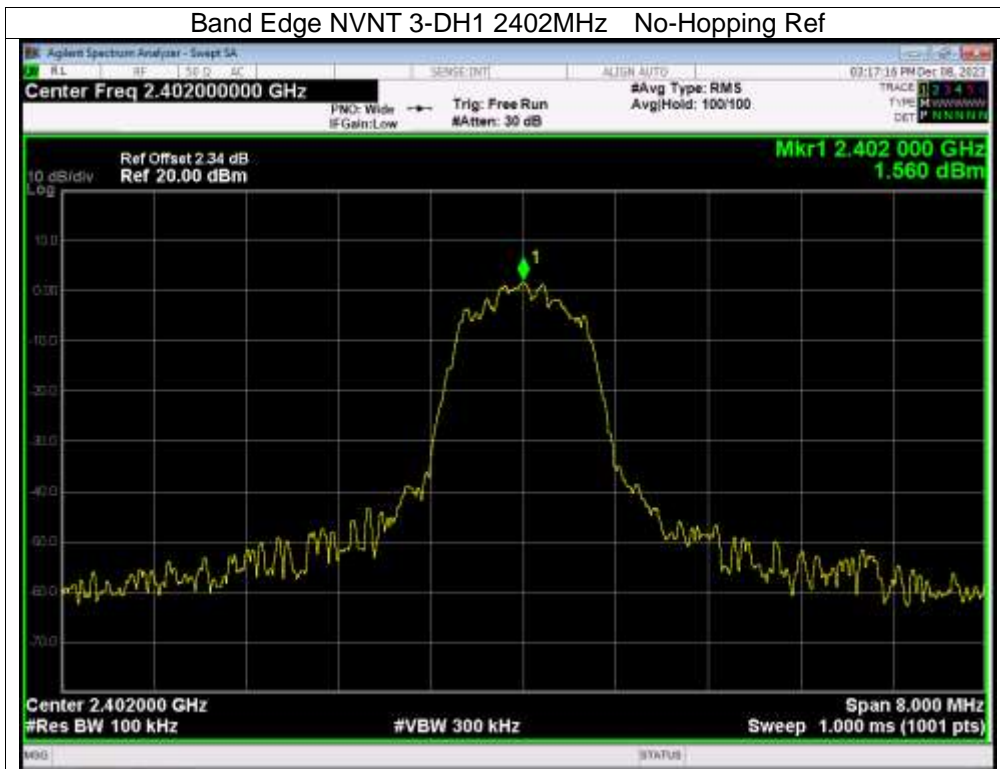

Band Edge NVNT 3-DH1 2402MHz No-Hopping Emission

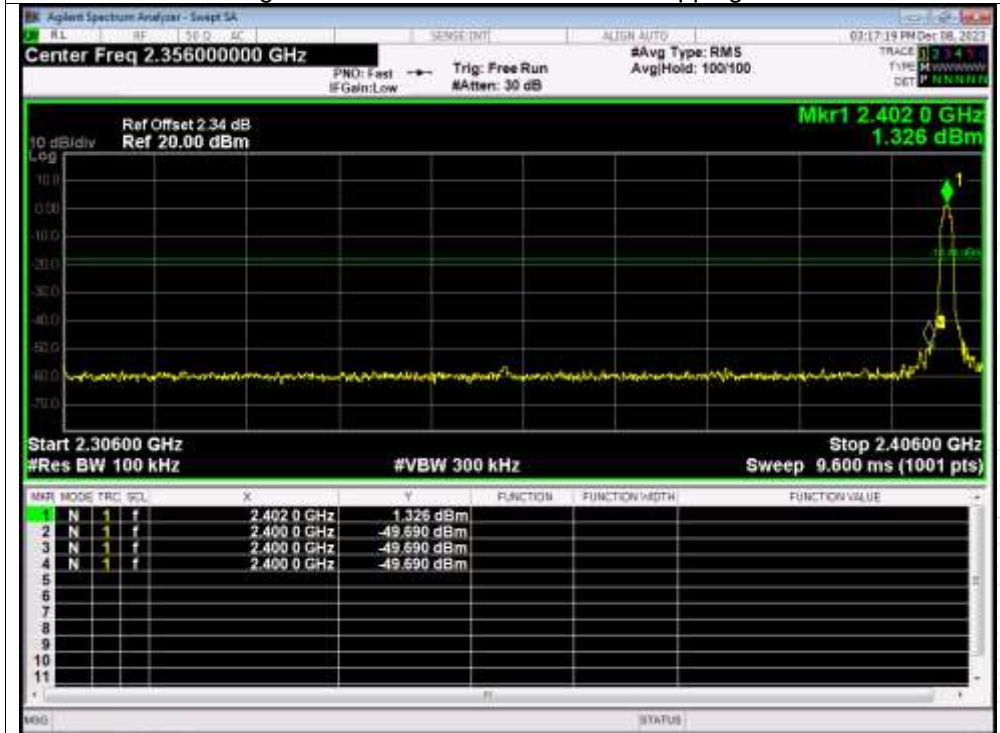

CO., LTD



## Band Edge NVNT 3-DH1 2480MHz No-Hopping Ref



## Band Edge NVNT 3-DH1 2480MHz No-Hopping Emission

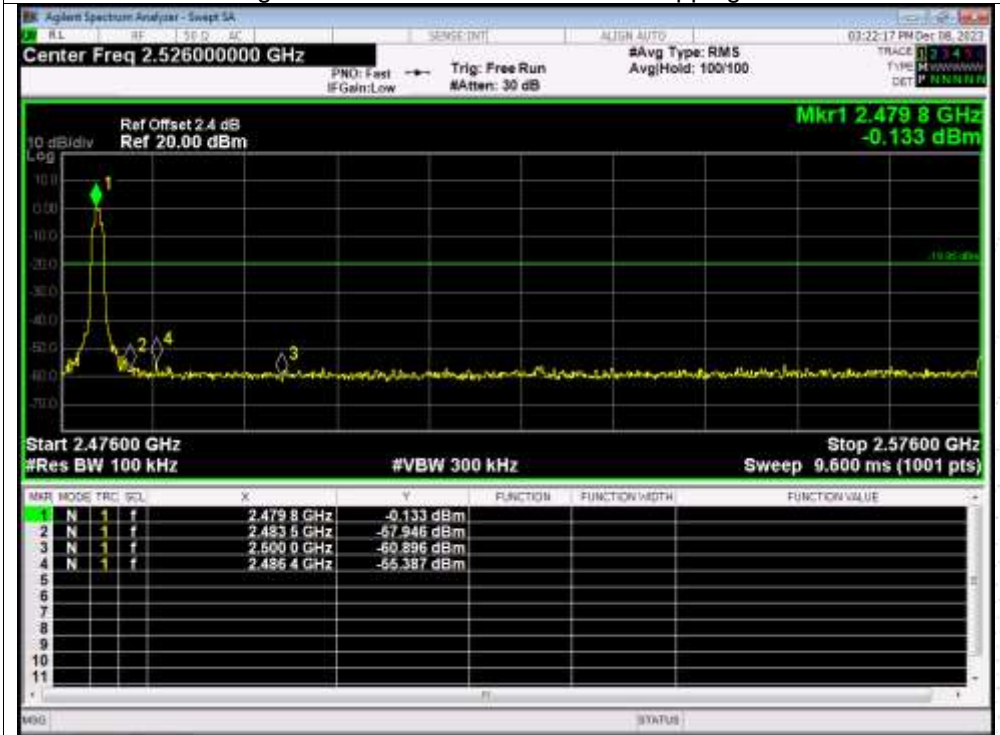

## Test Graphs

Band Edge(Hopping) NVNT 1-DH1 2402MHz Hopping Ref



Band Edge(Hopping) NVNT 1-DH1 2402MHz Hopping Emission

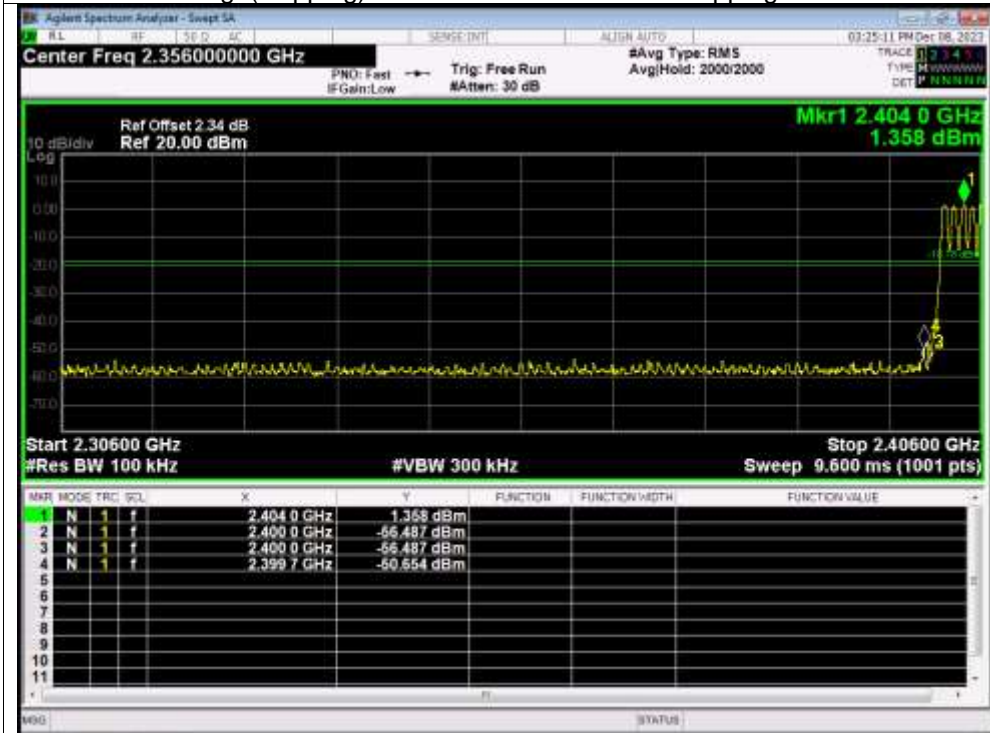

Band Edge(Hopping) NVNT 1-DH1 2480MHz Hopping Ref



Band Edge(Hopping) NVNT 1-DH1 2480MHz Hopping Emission

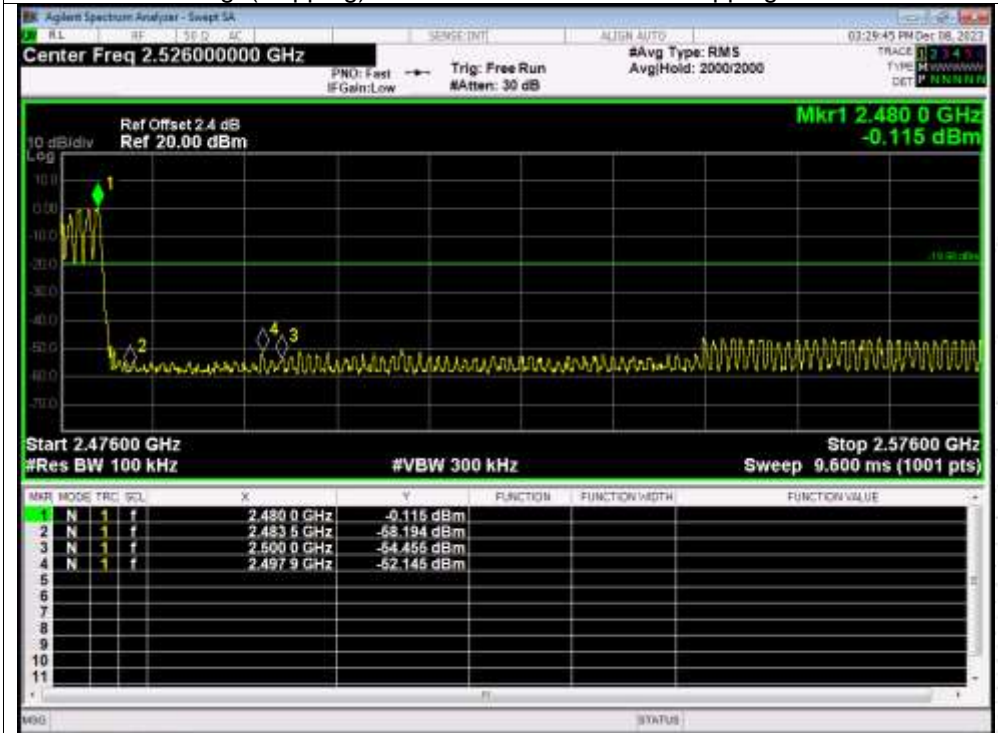

Band Edge(Hopping) NVNT 2-DH1 2402MHz Hopping Ref



Band Edge(Hopping) NVNT 2-DH1 2402MHz Hopping Emission

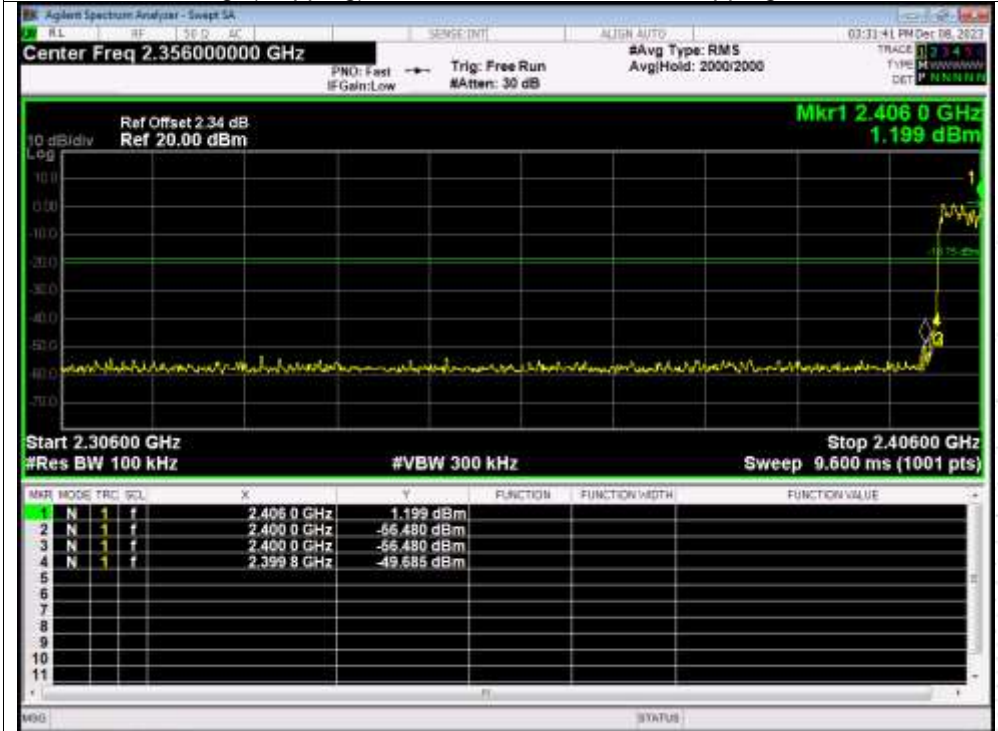



Band Edge(Hopping) NVNT 2-DH1 2480MHz Hopping Ref



Band Edge(Hopping) NVNT 2-DH1 2480MHz Hopping Emission

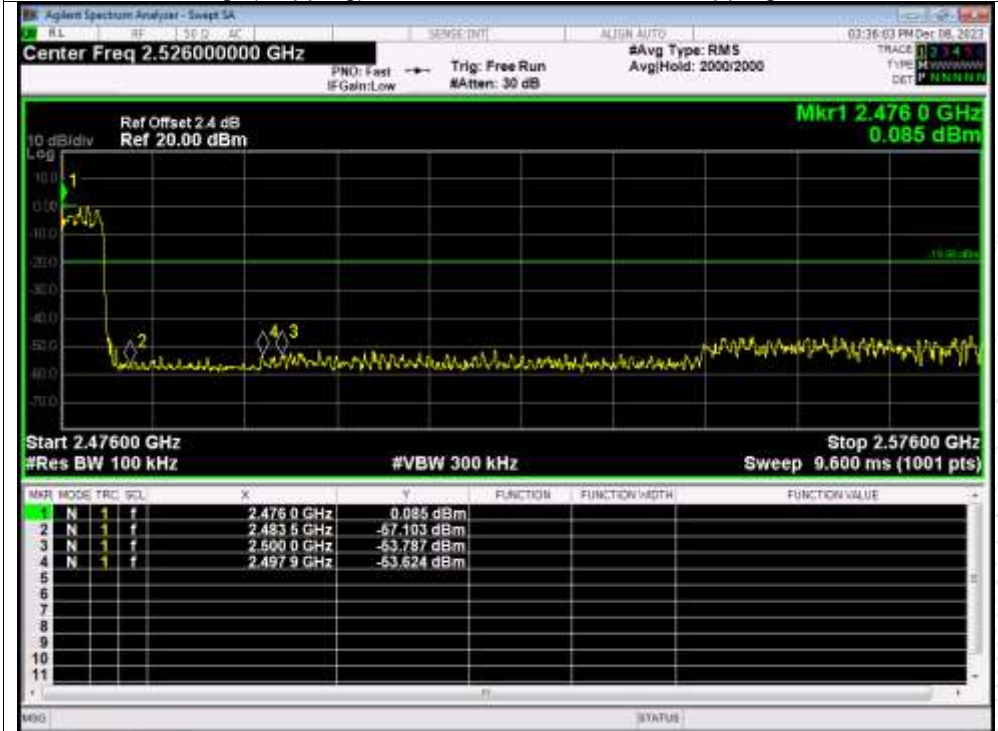

Band Edge(Hopping) NVNT 3-DH1 2402MHz Hopping Ref



Band Edge(Hopping) NVNT 3-DH1 2402MHz Hopping Emission

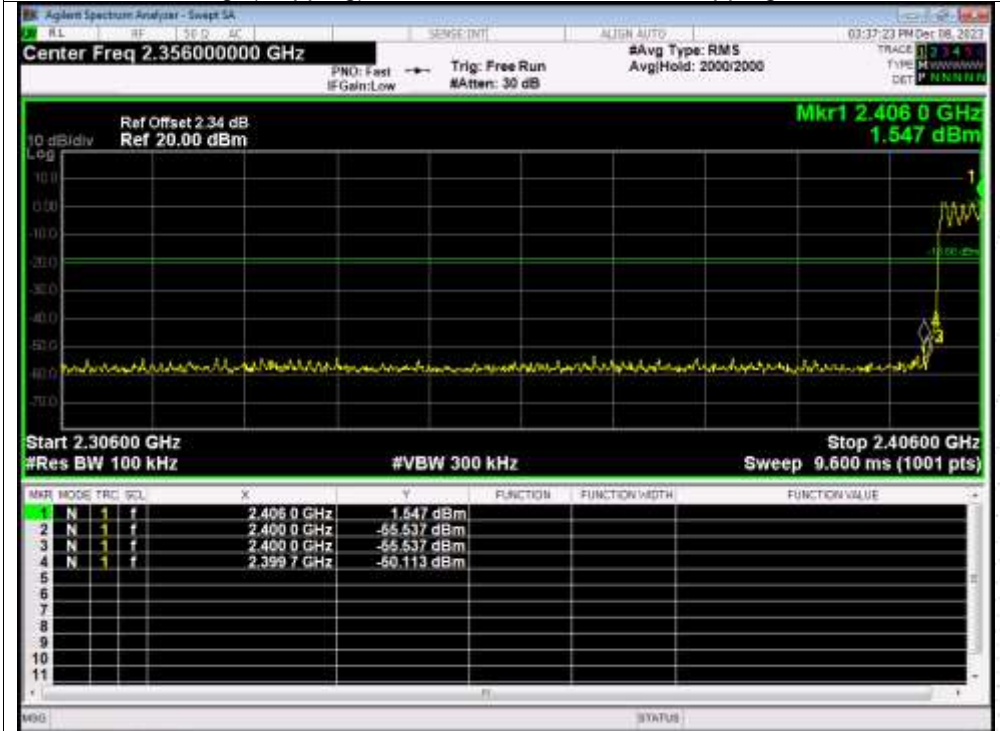

CO.LTD



Band Edge(Hopping) NVNT 3-DH1 2480MHz Hopping Ref



Band Edge(Hopping) NVNT 3-DH1 2480MHz Hopping Emission

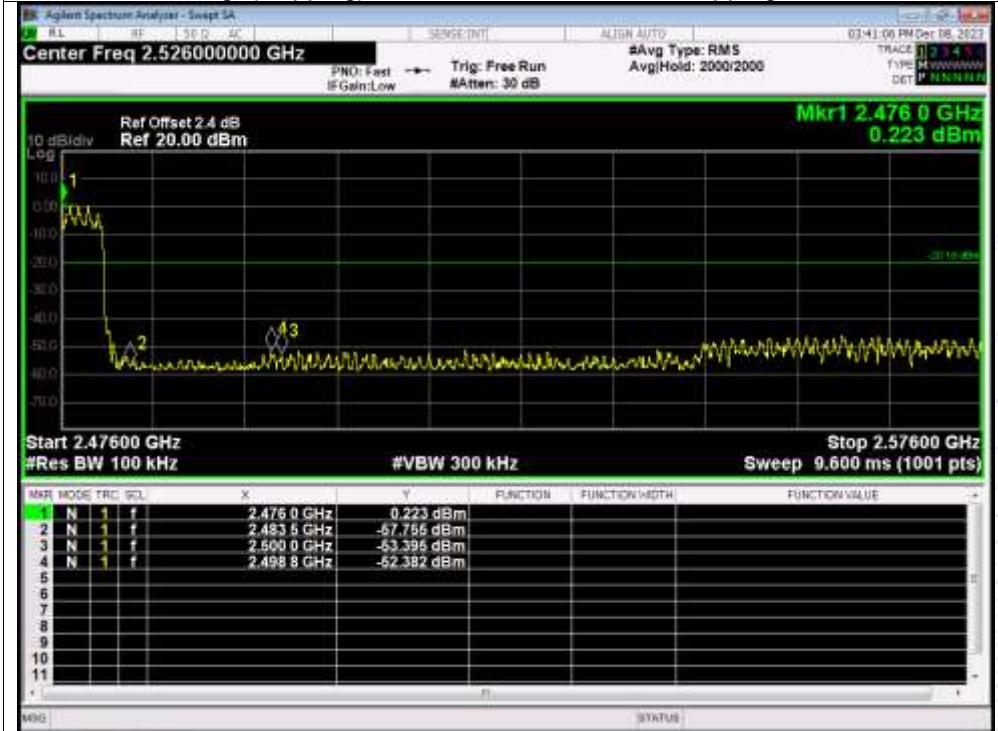

## 10. 20 dB Bandwidth

### 10.1 Block Diagram Of Test Setup



### 10.2 Limit

N/A

### 10.3 Test procedure

1. Set RBW = 30kHz.
2. Set the video bandwidth (VBW)  $\geq 3 \times$  RBW.
3. Detector = Peak.
4. Trace mode = max hold.
5. Sweep = auto couple.
6. Allow the trace to stabilize.
7. Measure the maximum width of the emission that is constrained by the frequencies associated with the two outermost amplitude points (upper and lower frequencies) that are attenuated by 6 dB relative to the maximum level measured in the fundamental emission.

### 10.4 Test Result

Condition	Mode	Frequency (MHz)	-20 dB Bandwidth (MHz)	Verdict
NVNT	1-DH1	2402	0.901	Pass
NVNT	1-DH1	2441	0.850	Pass
NVNT	1-DH1	2480	0.931	Pass
NVNT	2-DH1	2402	1.293	Pass
NVNT	2-DH1	2441	1.247	Pass
NVNT	2-DH1	2480	1.241	Pass
NVNT	3-DH1	2402	1.235	Pass
NVNT	3-DH1	2441	1.220	Pass
NVNT	3-DH1	2480	1.212	Pass

## Test Graphs

## -20dB Bandwidth NVNT 1-DH1 2402MHz



## -20dB Bandwidth NVNT 1-DH1 2441MHz











CO.LTD



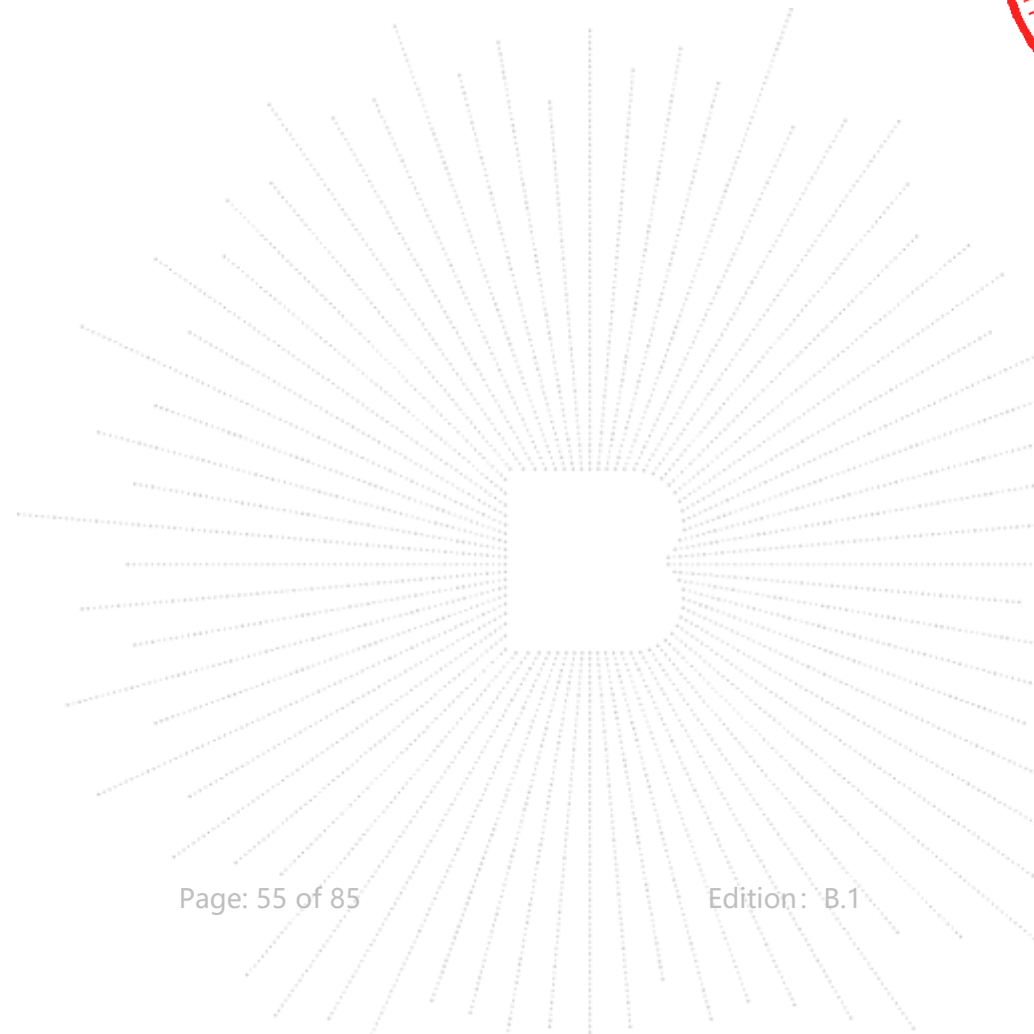

## 11. Maximum Peak Output Power

### 11.1 Block Diagram Of Test Setup

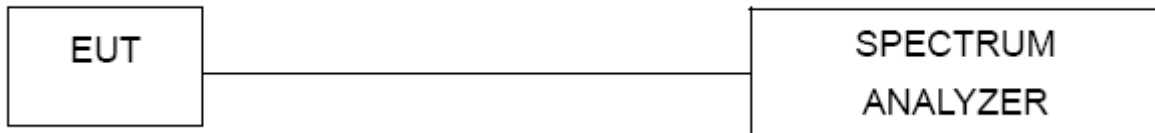

### 11.2 Limit

FCC Part15 (15.247) , Subpart C				
Section	Test Item	Limit	Frequency Range (MHz)	Result
15.247(b)(1)	Peak Output Power	0.125 watt or 21dBm	2400-2483.5	PASS

### 11.3 Test procedure

1. Remove the antenna from the EUT and then connect a low RF cable from the antenna port to the spectrum.
2. Set the spectrum analyzer: RBW = 2MHz. VBW = 6MHz. Sweep = auto; Detector Function = Peak.
3. Keep the EUT in transmitting at lowest, medium and highest channel individually. Record the max value.

### 11.4 Test Result

Condition	Mode	Frequency (MHz)	Conducted Power (dBm)	Limit (dBm)	Verdict
NVNT	1-DH1	2402	1.72	21	Pass
NVNT	1-DH1	2441	1.38	21	Pass
NVNT	1-DH1	2480	0.13	21	Pass
NVNT	2-DH1	2402	3.73	21	Pass
NVNT	2-DH1	2441	3.37	21	Pass
NVNT	2-DH1	2480	2.13	21	Pass
NVNT	3-DH1	2402	4.41	21	Pass
NVNT	3-DH1	2441	4.12	21	Pass
NVNT	3-DH1	2480	2.96	21	Pass

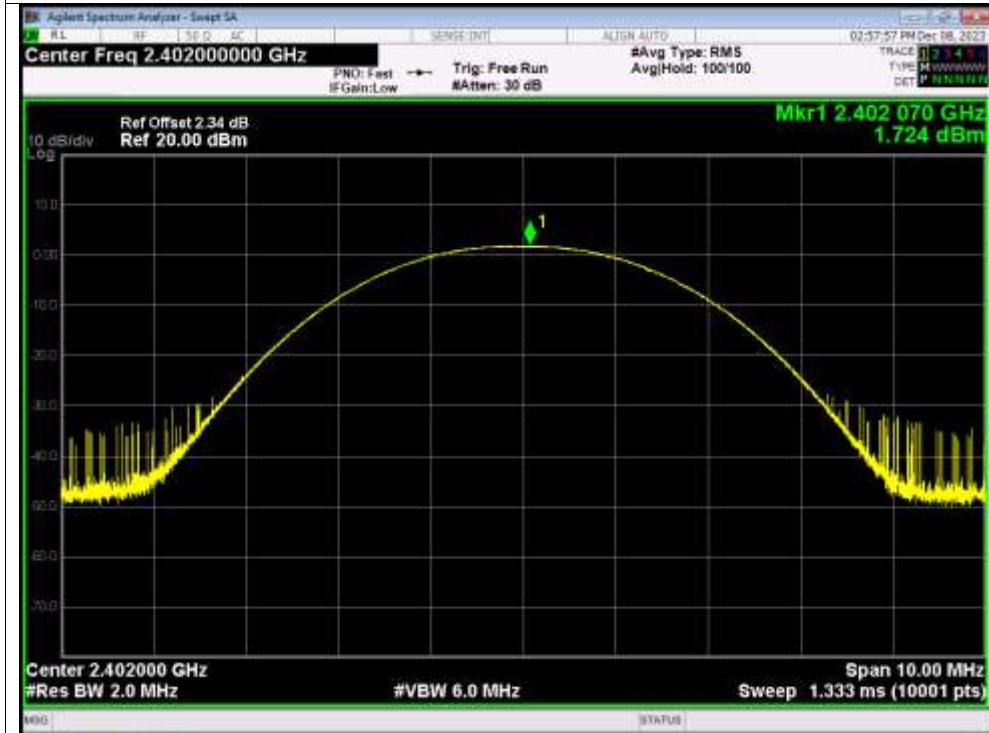
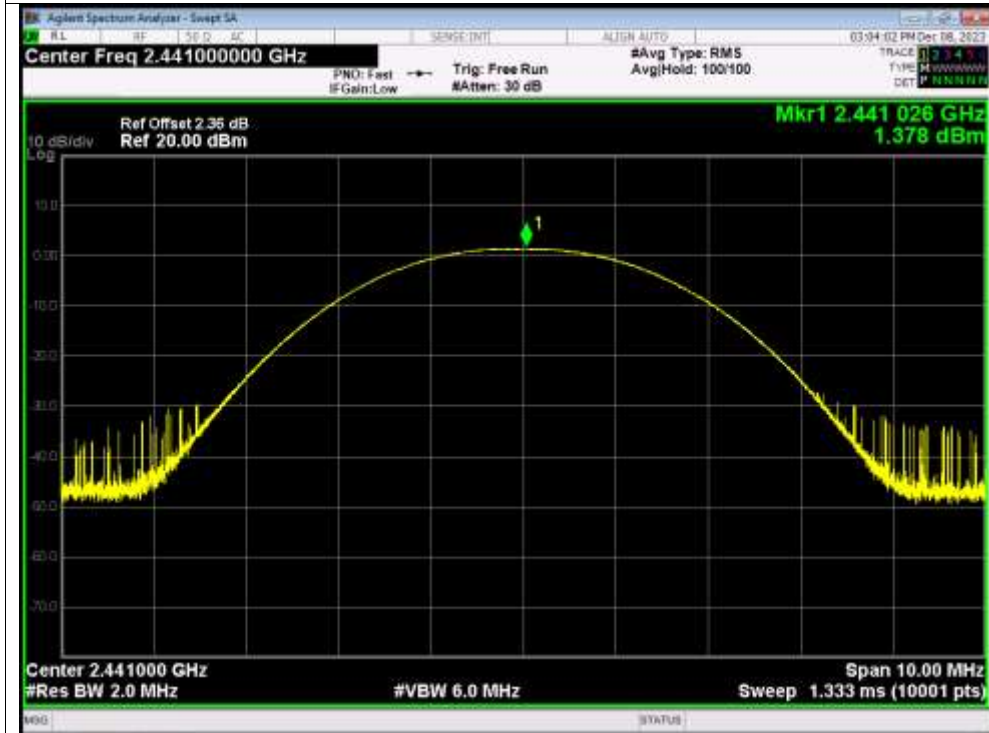
**Test Graphs**
**Power NVNT 1-DH1 2402MHz**

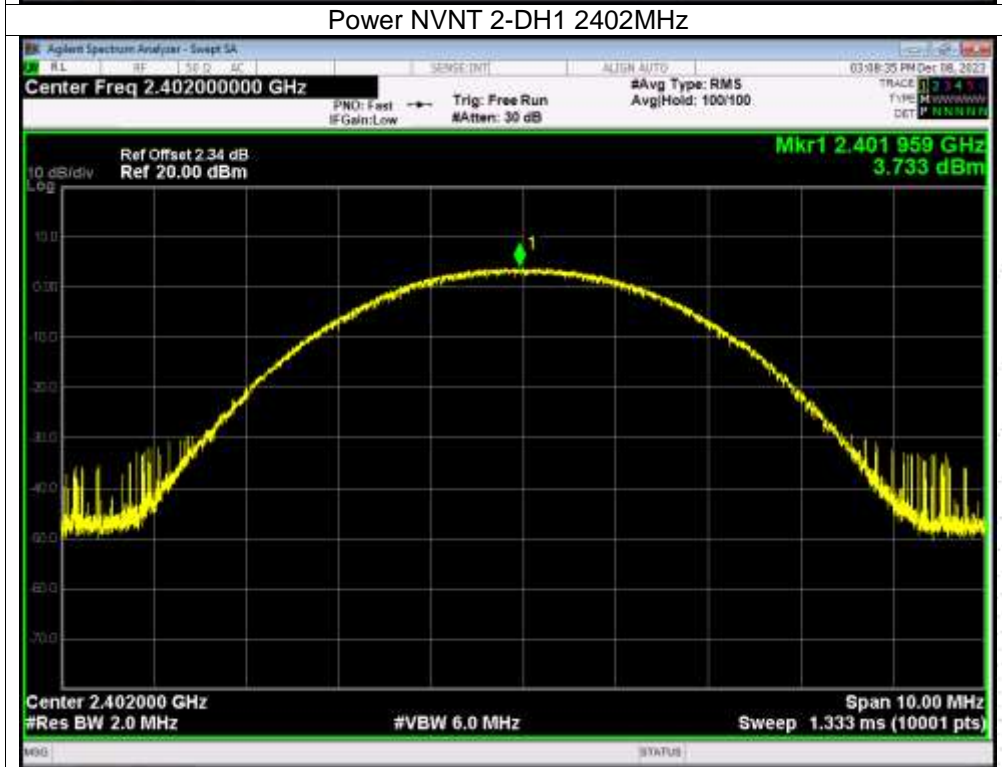
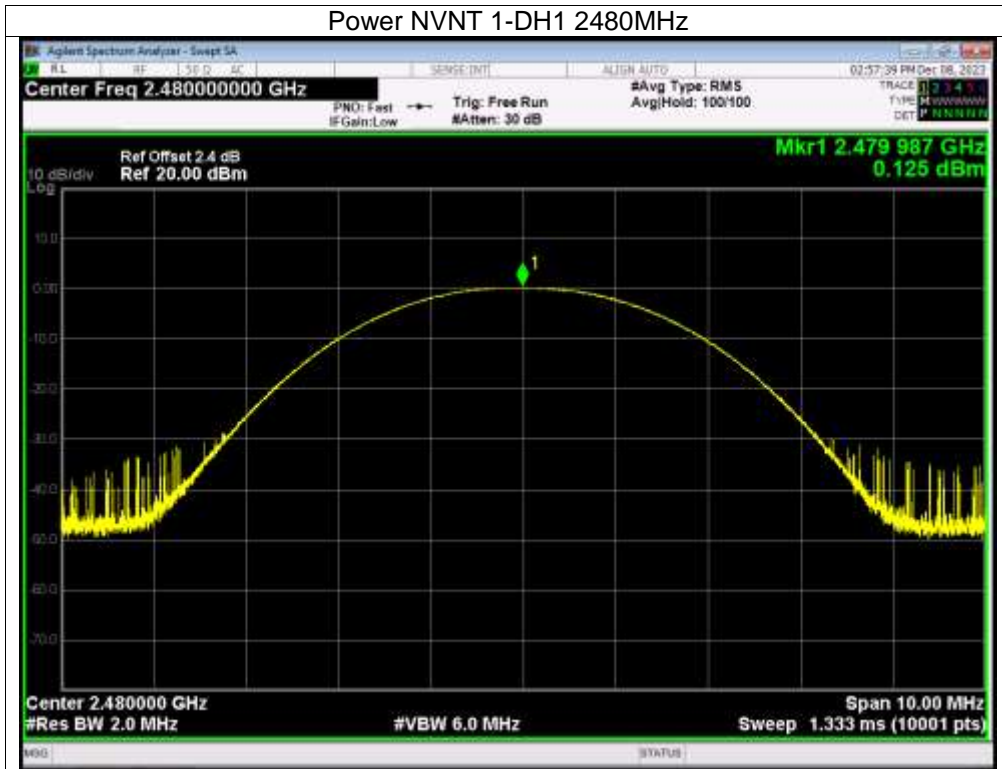
**Power NVNT 1-DH1 2441MHz**

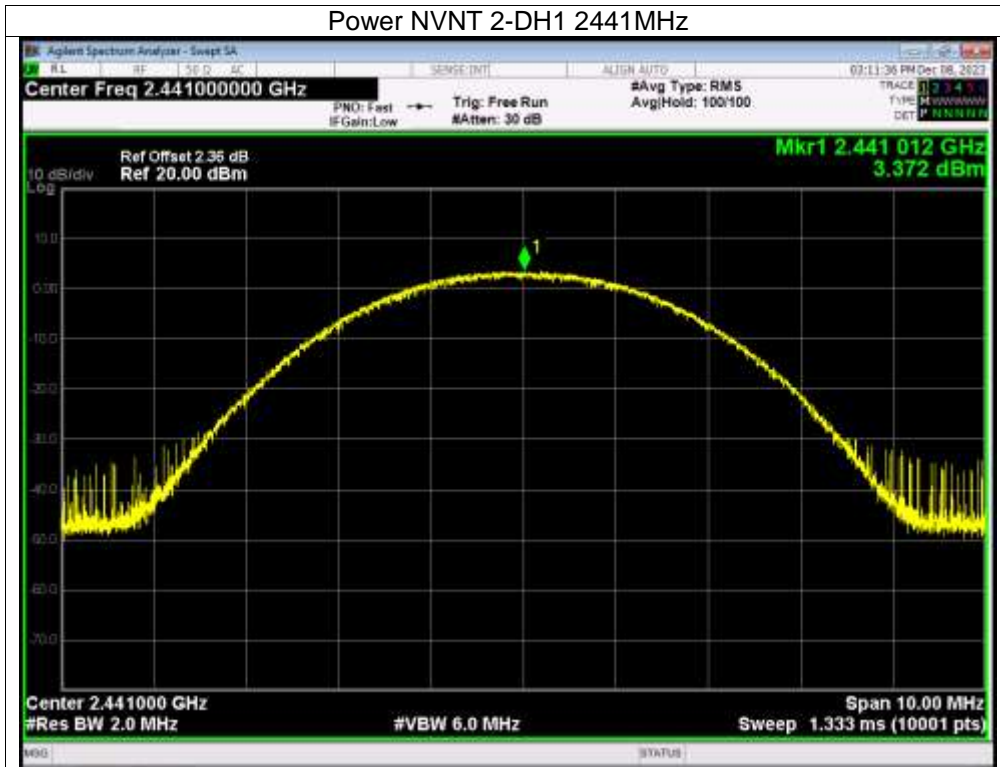

Power NVNT 2-DH1 2441MHz

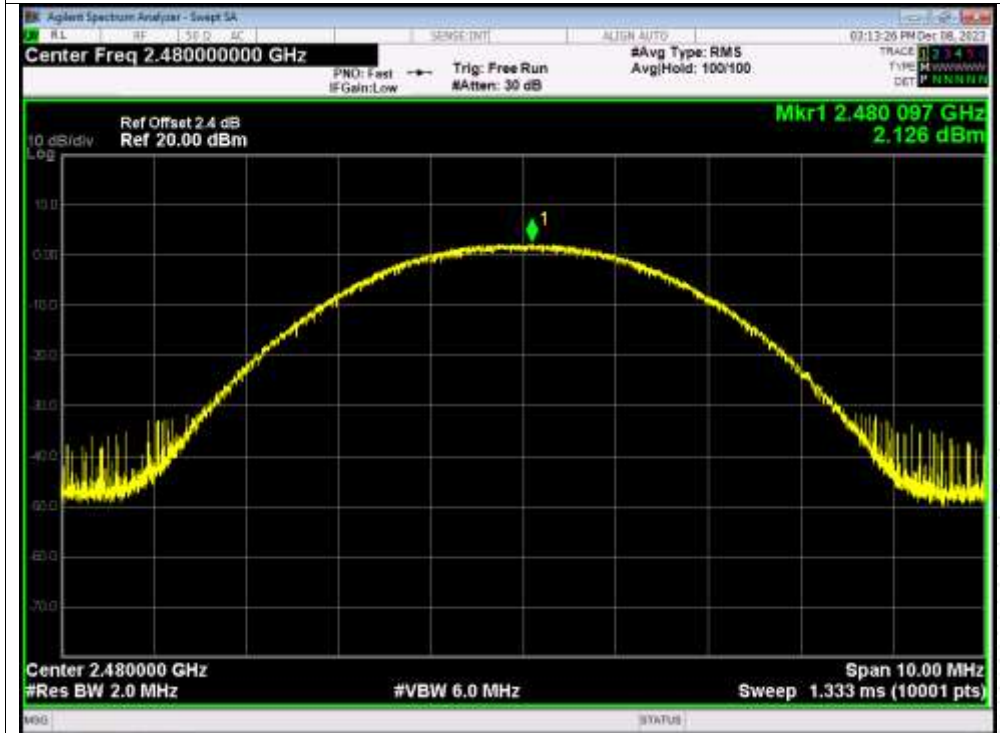

Power NVNT 2-DH1 2480MHz





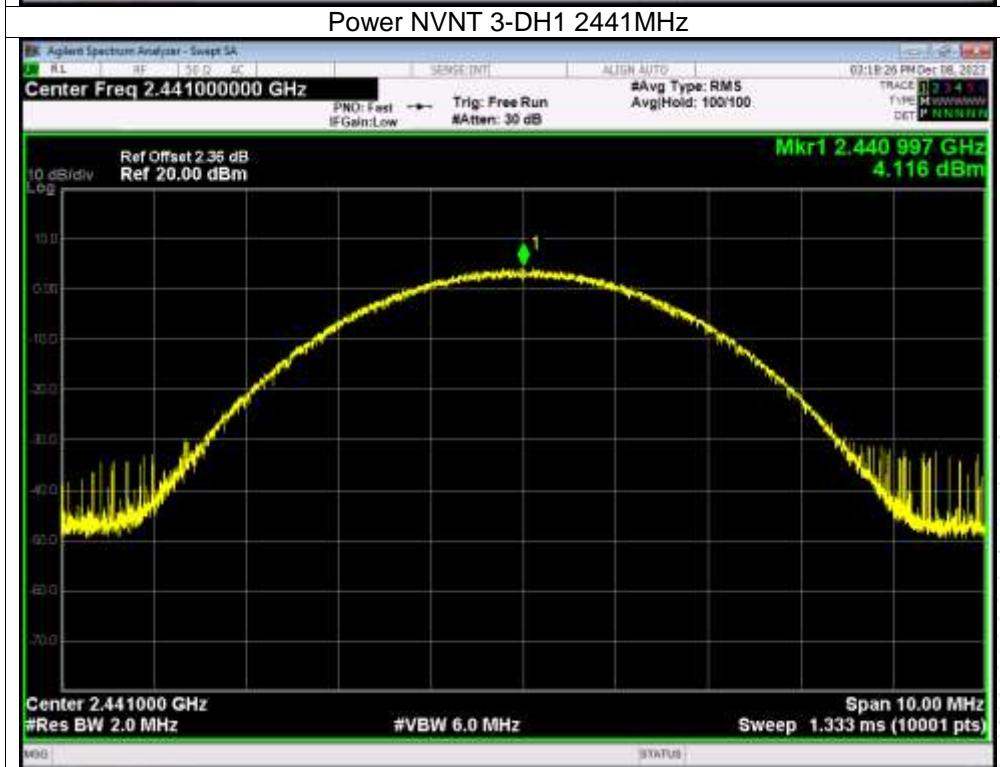
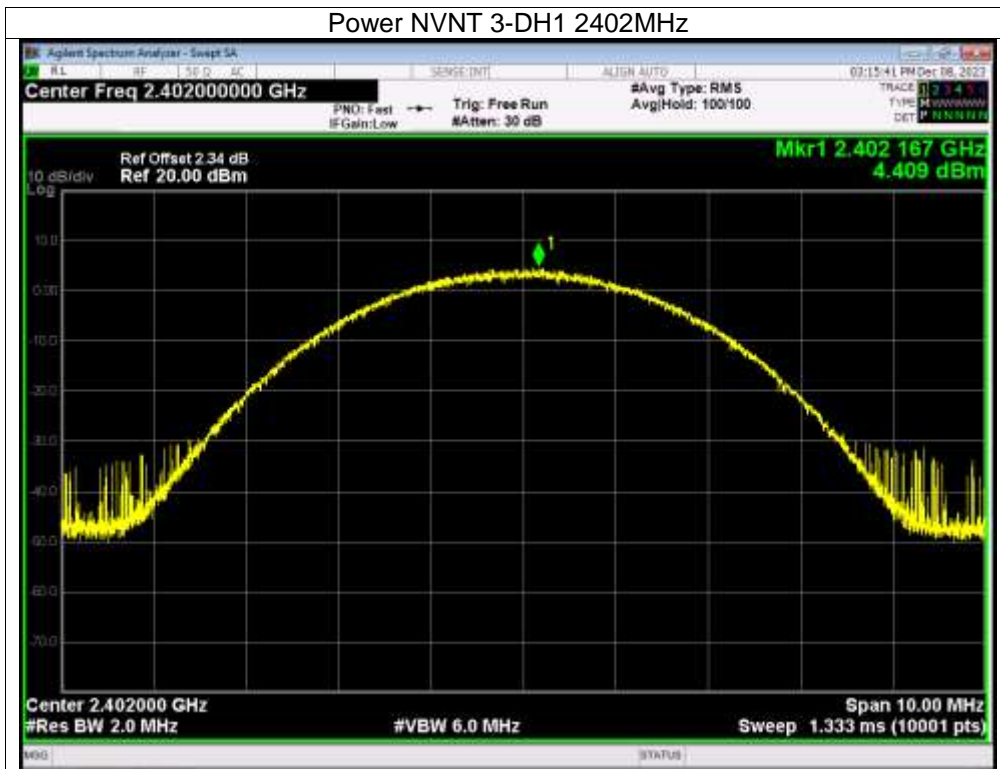

CO., LTD

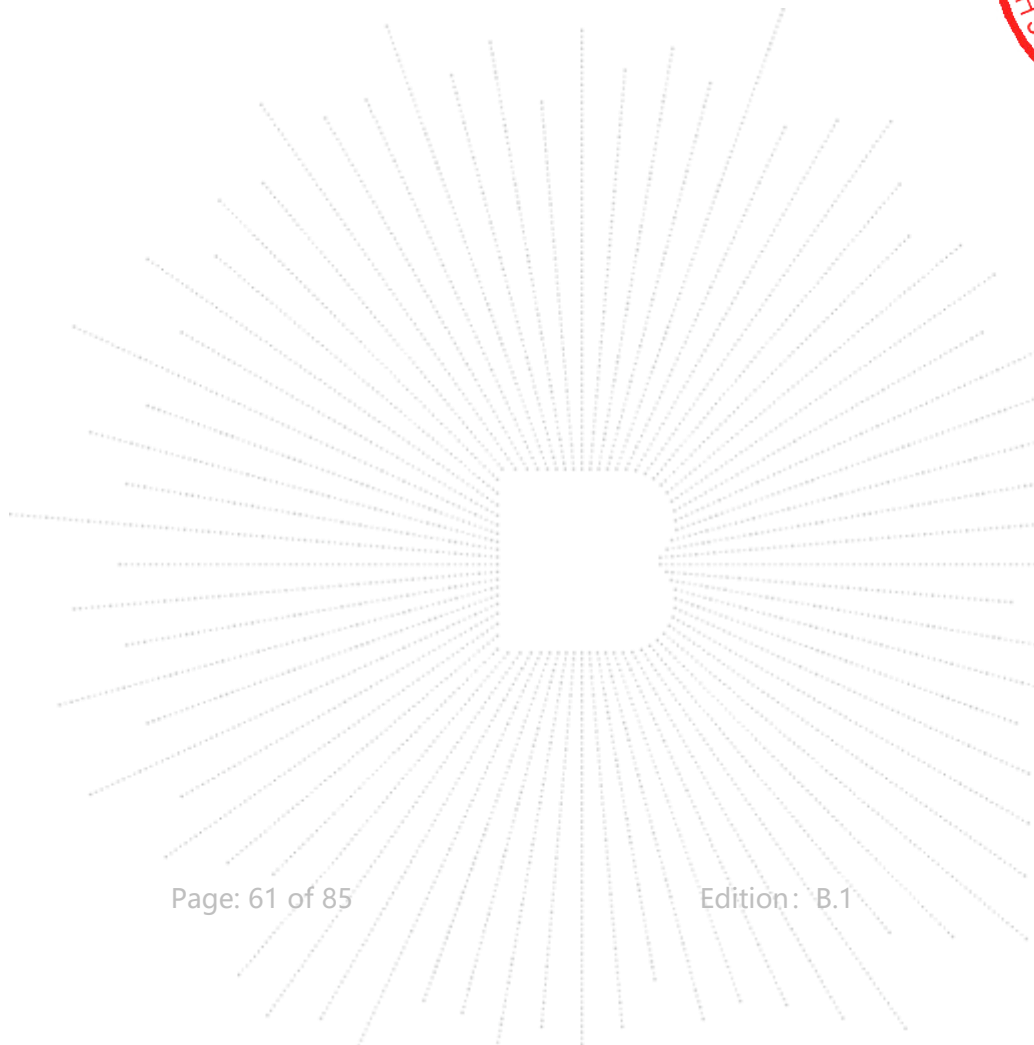
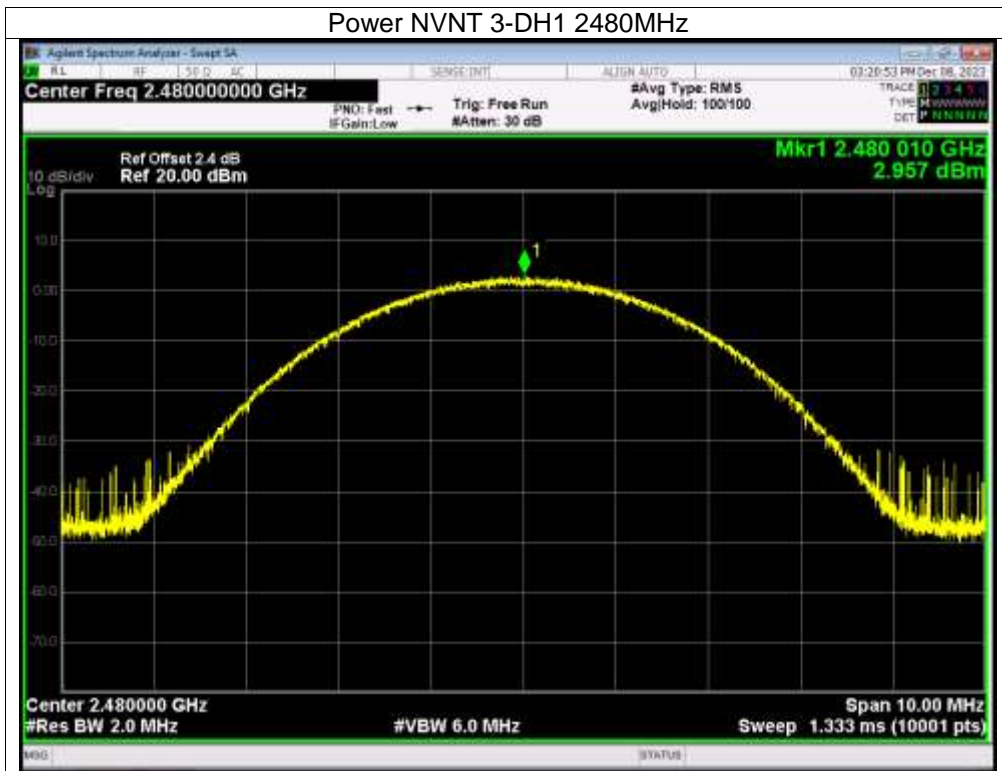

## 12. Hopping Channel Separation

### 12.1 Block Diagram Of Test Setup



### 12.2 Limit

Frequency hopping systems shall have hopping channel carrier frequencies separated by a minimum of 25 kHz or the 20 dB bandwidth of the hopping channel, whichever is greater. Alternatively, frequency hopping systems operating in the 2400-2483.5 MHz band may have hopping channel carrier frequencies that are separated by 25 kHz or two-thirds of the 20 dB bandwidth of the hopping channel, whichever is greater, provided the systems operate with an output power no greater than 0.125W.

### 12.3 Test procedure

1. Remove the antenna from the EUT and then connect a low RF cable from the antenna port to the spectrum.
2. Set the spectrum analyzer: RBW = 30kHz. VBW = 100kHz , Span = 2.0MHz. Sweep = auto; Detector Function = Peak. Trace = Max hold.
3. Allow the trace to stabilize. Use the marker-delta function to determine the separation between the peaks of the adjacent channels. The limit is specified in one of the subparagraphs of this Section Submit this plot.

### 12.4 Test Result

Modulation	Test Channel	Separation (MHz)	Limit(MHz)	Result
GFSK	Low	0.998	0.601	PASS
GFSK	Middle	1.002	0.567	PASS
GFSK	High	1.002	0.621	PASS
$\pi/4$ DQPSK	Low	1.002	0.862	PASS
$\pi/4$ DQPSK	Middle	0.878	0.831	PASS
$\pi/4$ DQPSK	High	1.000	0.827	PASS
8DPSK	Low	1.002	0.823	PASS
8DPSK	Middle	1.002	0.813	PASS
8DPSK	High	1.000	0.808	PASS

## Test Graphs

## CFS NVNT 1-DH1 2402MHz



## CFS NVNT 1-DH1 2441MHz



CFS NVNT 1-DH1 2480MHz



CFS NVNT 2-DH1 2402MHz

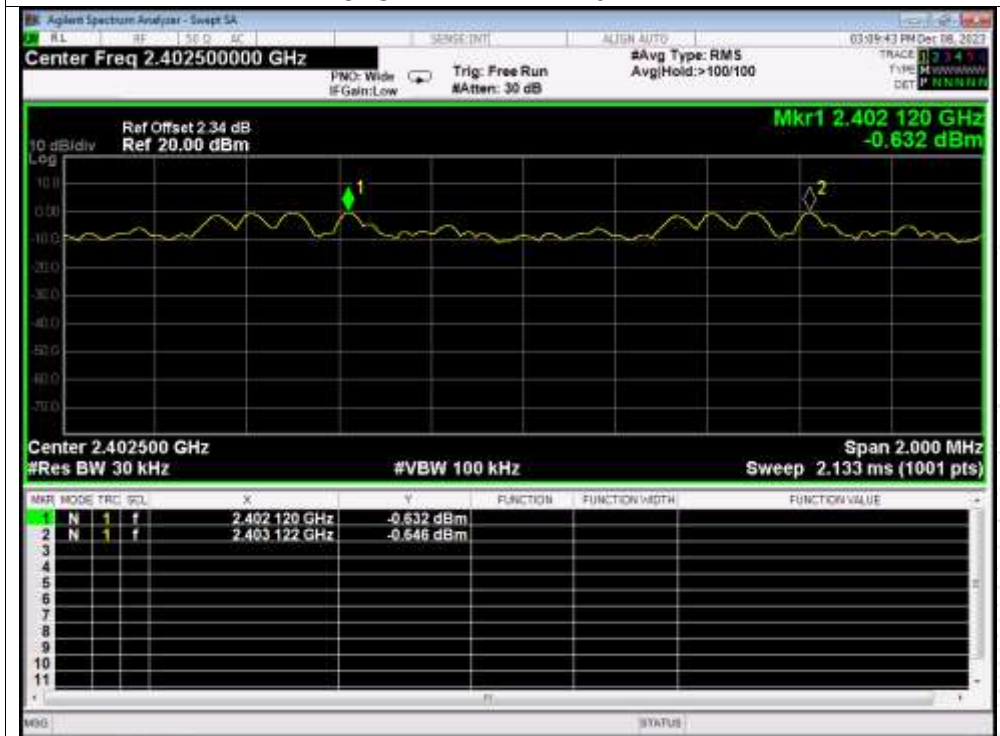



CFS NVNT 2-DH1 2441MHz

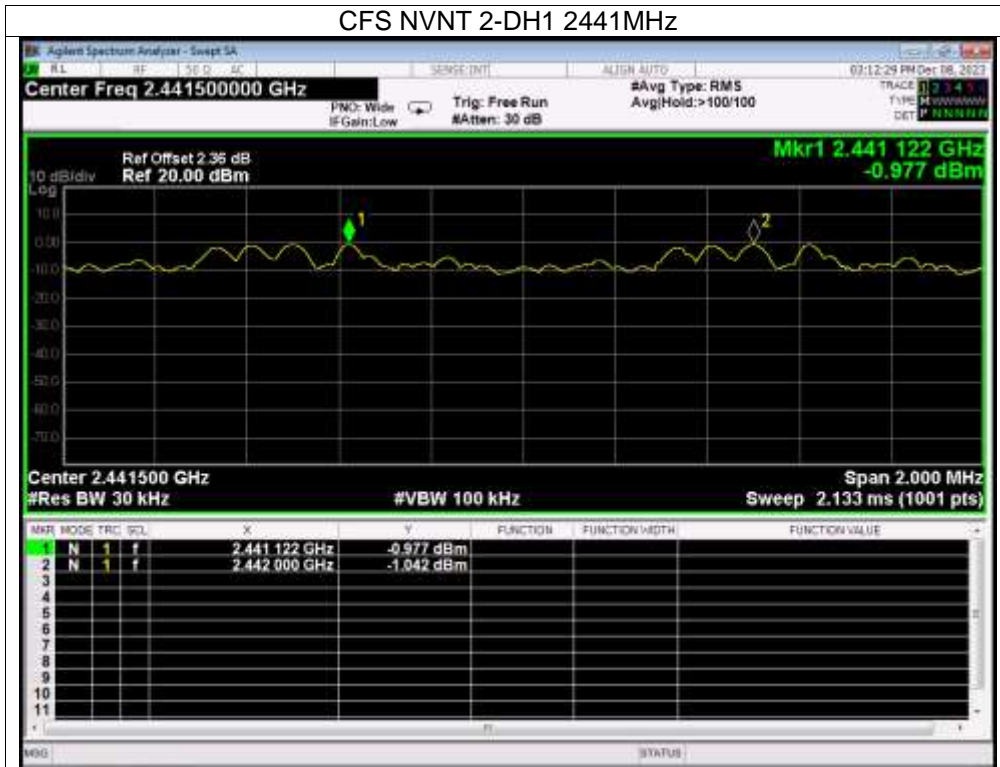

CFS NVNT 2-DH1 2480MHz

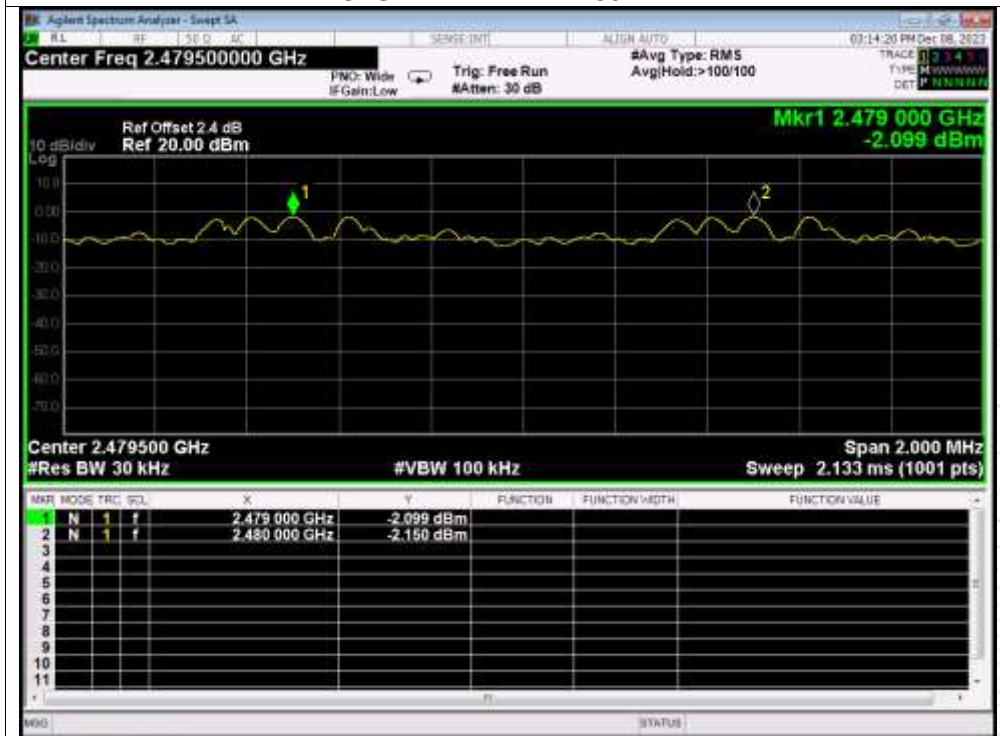

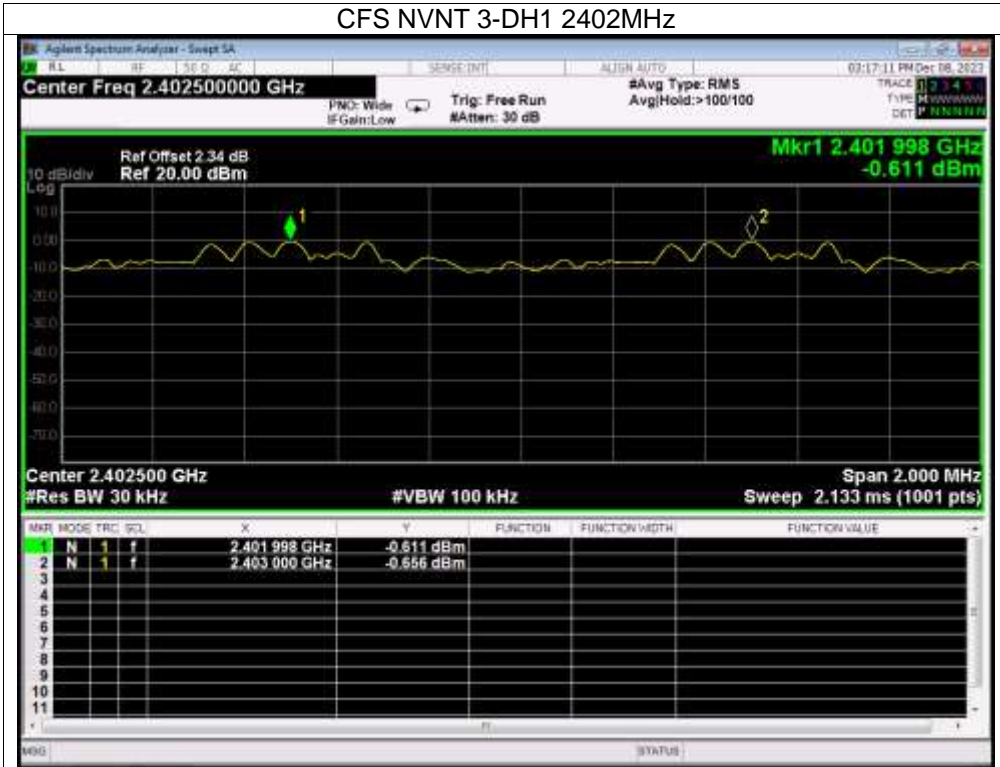
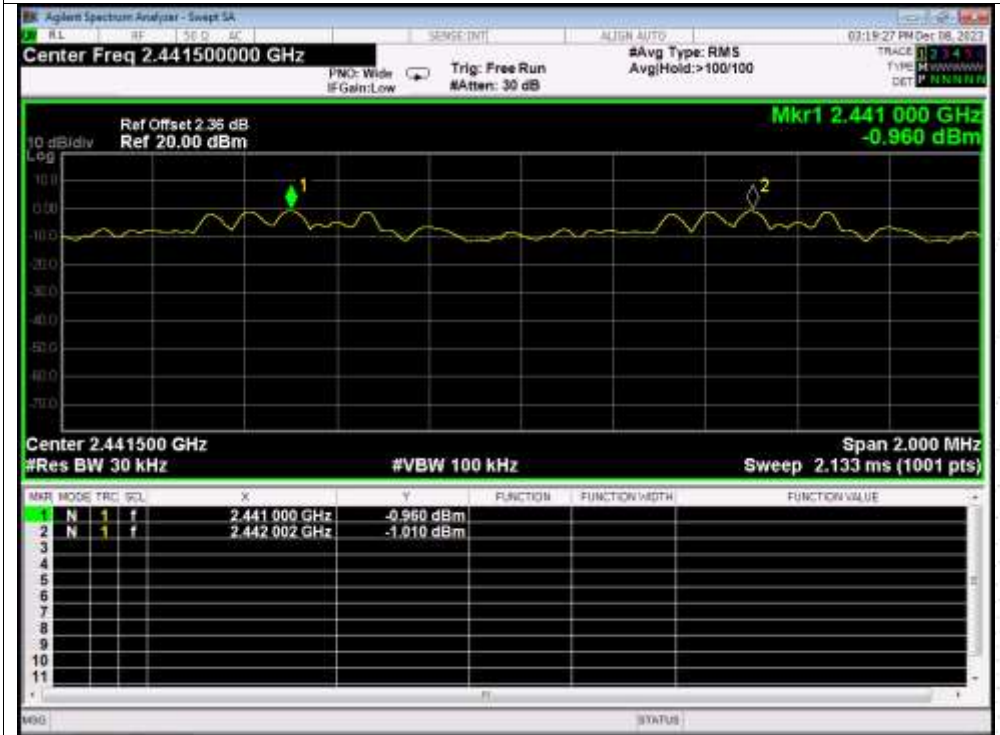
**CFS NVNT 3-DH1 2402MHz**

**CFS NVNT 3-DH1 2441MHz**

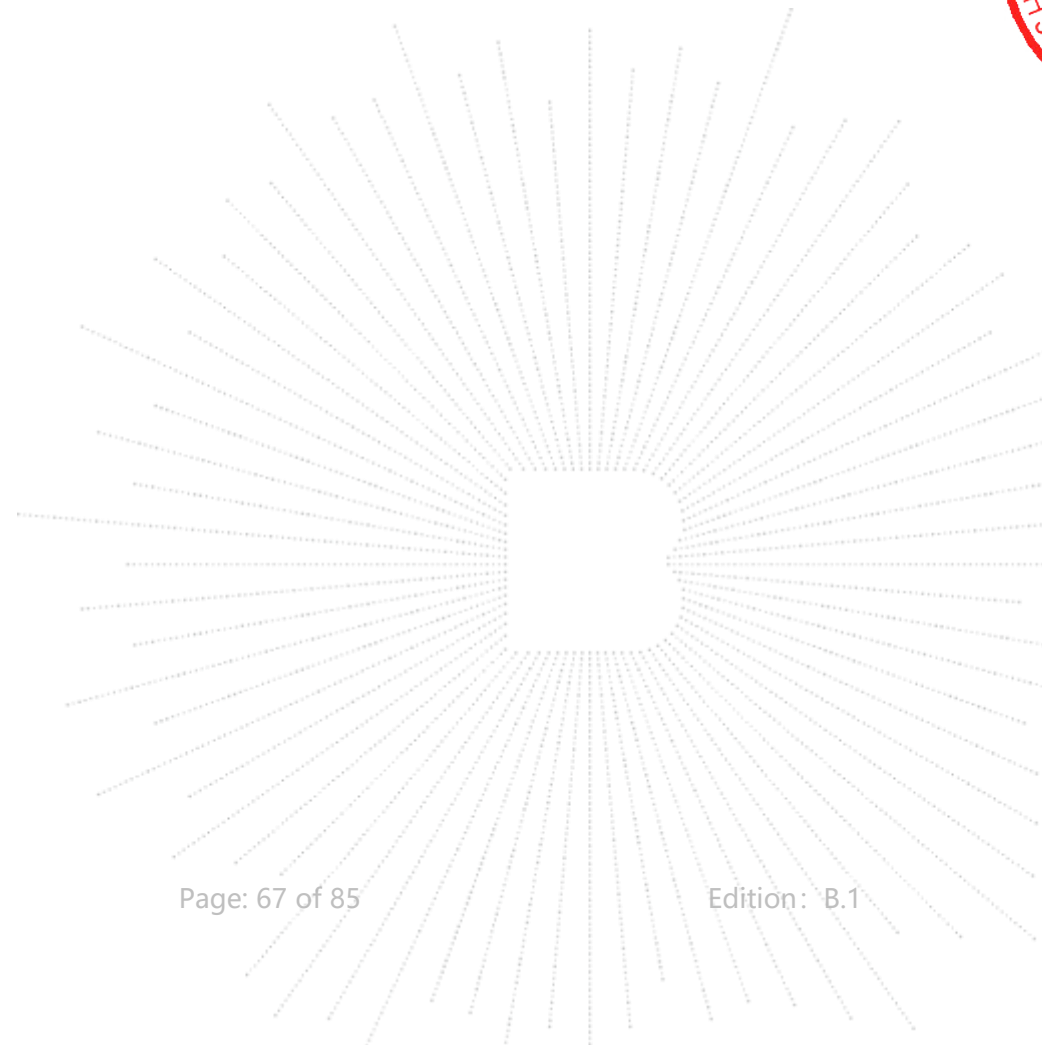
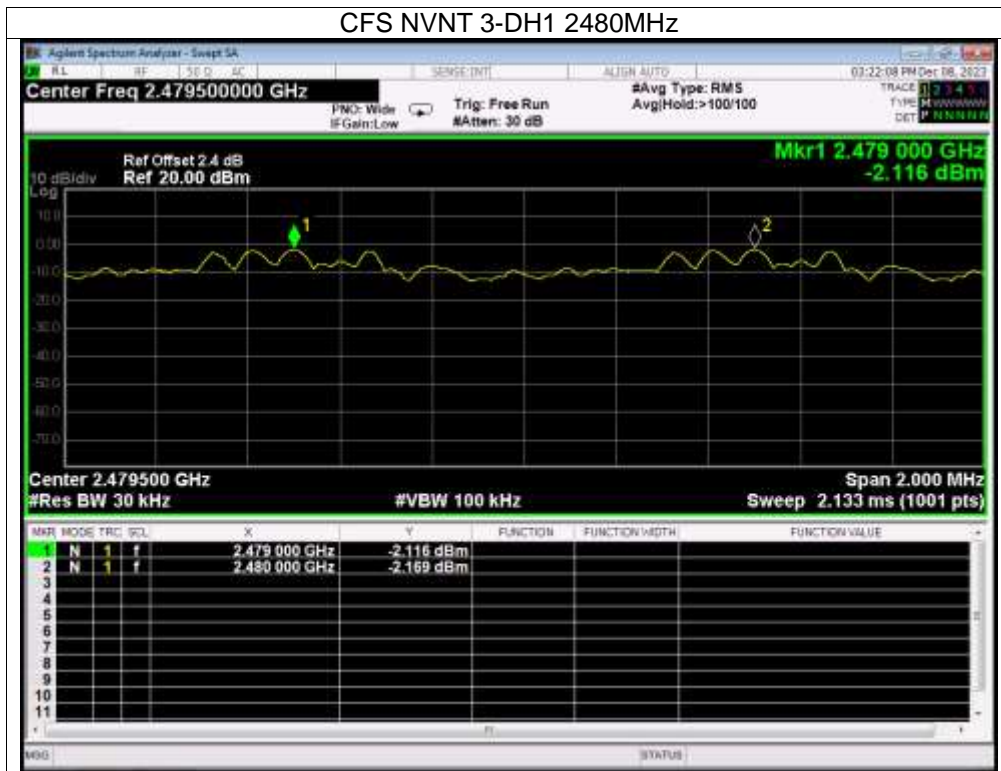
CO., LTD



### 13. Number Of Hopping Frequency

#### 13.1 Block Diagram Of Test Setup



#### 13.2 Limit

Frequency hopping systems in the 2400-2483.5 MHz band shall use at least 15 channels.

#### 13.3 Test procedure

1. Remove the antenna from the EUT and then connect a low RF cable from the antenna port to the spectrum.
2. Set the spectrum analyzer: RBW = 100kHz. VBW = 300kHz. Sweep = auto; Detector Function = Peak. Trace = Max hold.
3. Allow the trace to stabilize. It may prove necessary to break the span up to sections. in order to clearly show all of the hopping frequencies. The limit is specified in one of the subparagraphs of this Section.
4. Set the spectrum analyzer: Start Frequency = 2.4GHz, Stop Frequency = 2.4835GHz. Sweep=auto;

#### 13.4 Test Result

Condition	Mode	Hopping Number	Limit	Verdict
NVNT	1-DH1	79	15	Pass
NVNT	2-DH1	79	15	Pass
NVNT	3-DH1	79	15	Pass





## Test Graphs

## Hopping No. NVNT 1-DH1 2441MHz

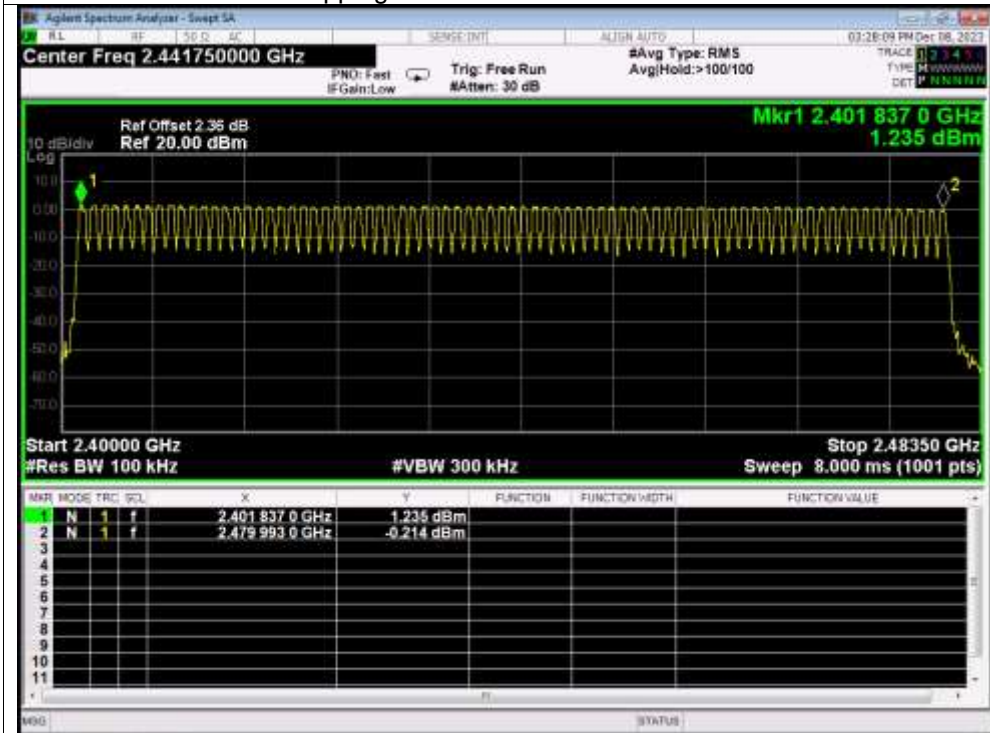

## Hopping No. NVNT 2-DH1 2441MHz

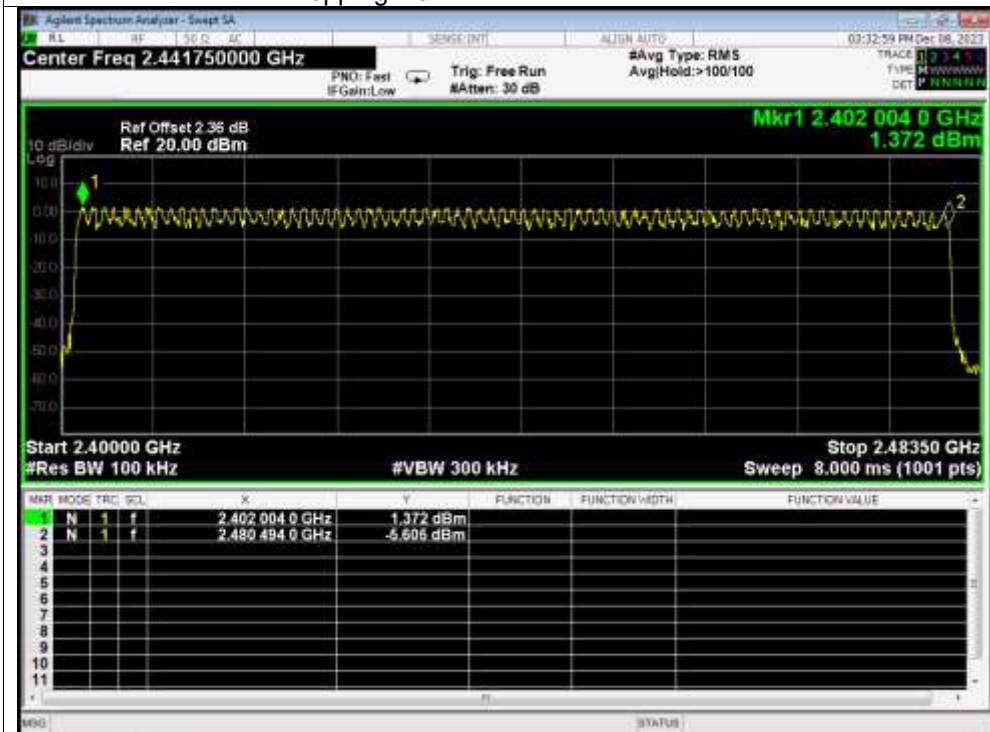



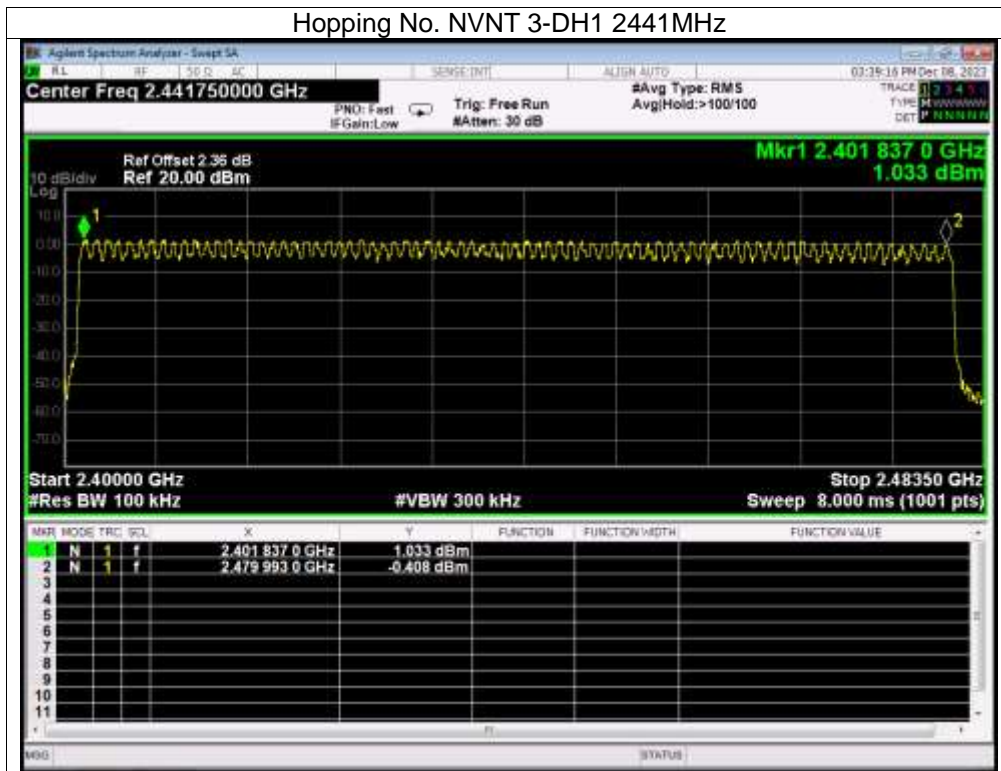

TEC  
TO  
OVB  
t See

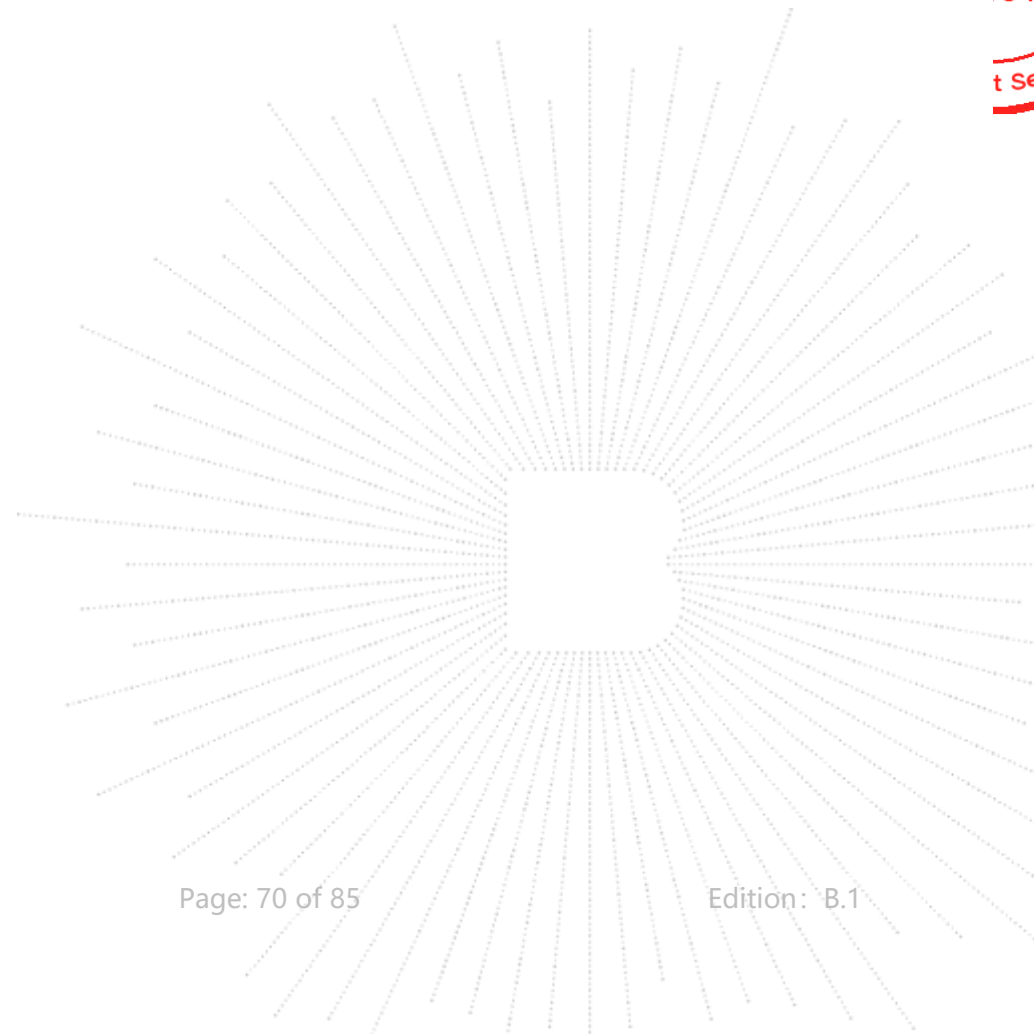

## 14. Dwell Time

### 14.1 Block Diagram Of Test Setup

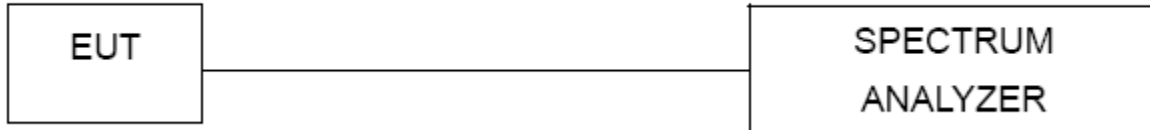

### 14.2 Limit

Frequency hopping systems in the 2400-2483.5 MHz band shall use at least 15 channels. The average time of occupancy on any channel shall not be greater than 0.4 seconds within a period of 0.4 seconds multiplied by the number of hopping channels employed. Frequency hopping systems may avoid or suppress transmissions on a particular hopping frequency provided that a minimum of 15 channels are used.

### 14.3 Test procedure

1. Remove the antenna from the EUT and then connect a low RF cable from the antenna port to the spectrum.
2. Set spectrum analyzer span = 0. Centred on a hopping channel;
3. Set RBW = 1MHz and VBW = 3MHz. Sweep = as necessary to capture the entire dwell time per hopping channel. Set the EUT for DH5, DH3 and DH1 packet transmitting.
4. Use the marker-delta function to determine the dwell time. If this value varies with different modes of operation (e.g.. data rate. modulation format. etc.), repeat this test for each variation. The limit is specified in one of the subparagraphs of this Section. Submit this plot(s).

### 14.4 Test Result

Mode	Frequency (MHz)	Pulse Time (ms)	Total Dwell Time (ms)	Burst Count	Period Time (ms)	Limit (ms)	Verdict
1-DH1	2441	0.398	126.564	318	31600	400	Pass
1-DH3	2441	1.654	279.526	169	31600	400	Pass
1-DH5	2441	2.904	322.344	111	31600	400	Pass
2-DH1	2441	0.41	130.79	319	31600	400	Pass
2-DH3	2441	1.661	264.099	159	31600	400	Pass
2-DH5	2441	2.908	305.34	105	31600	400	Pass
3-DH1	2441	0.408	129.336	317	31600	400	Pass
3-DH3	2441	1.66	255.64	154	31600	400	Pass
3-DH5	2441	2.908	343.144	118	31600	400	Pass

Note: Total Dwell Time (ms) = Pulse Time (ms)\*Burst Count

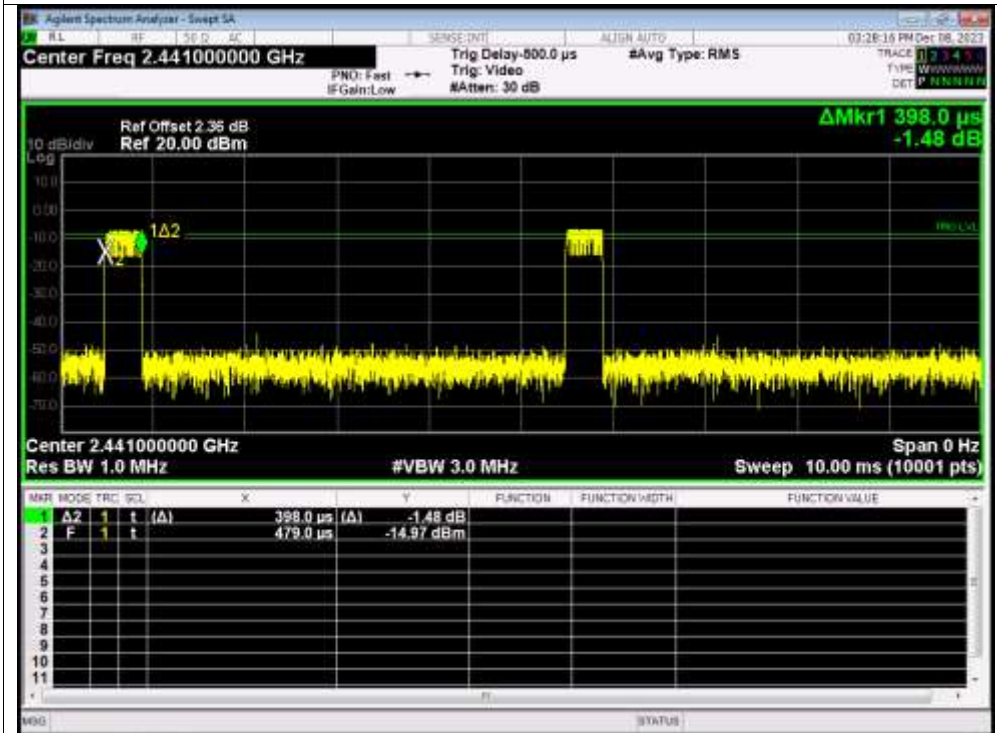
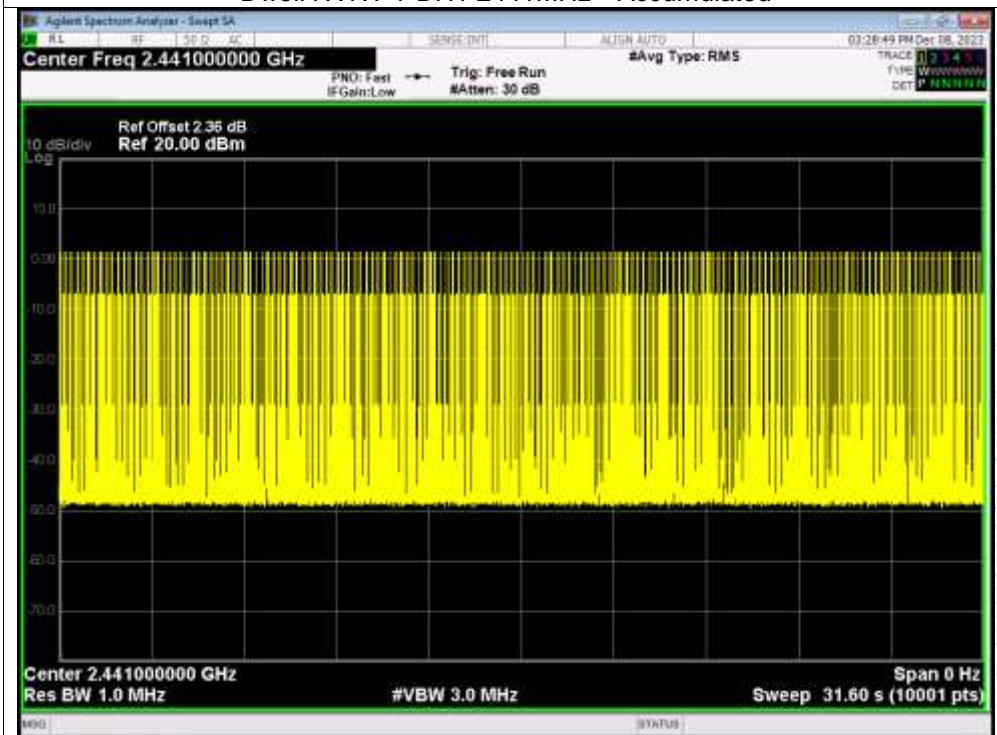
**Test Graphs**
**Dwell NVNT 1-DH1 2441MHz One Burst**

**Dwell NVNT 1-DH1 2441MHz Accumulated**

CO., LTD

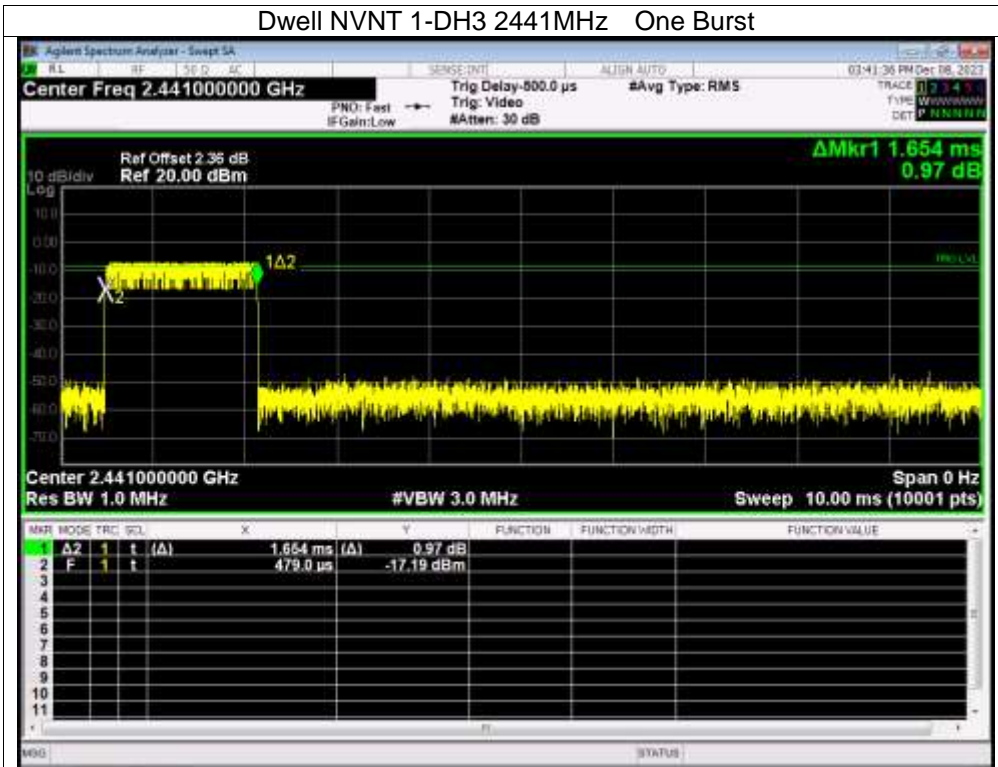
Dwell NVNT 1-DH3 2441MHz One Burst

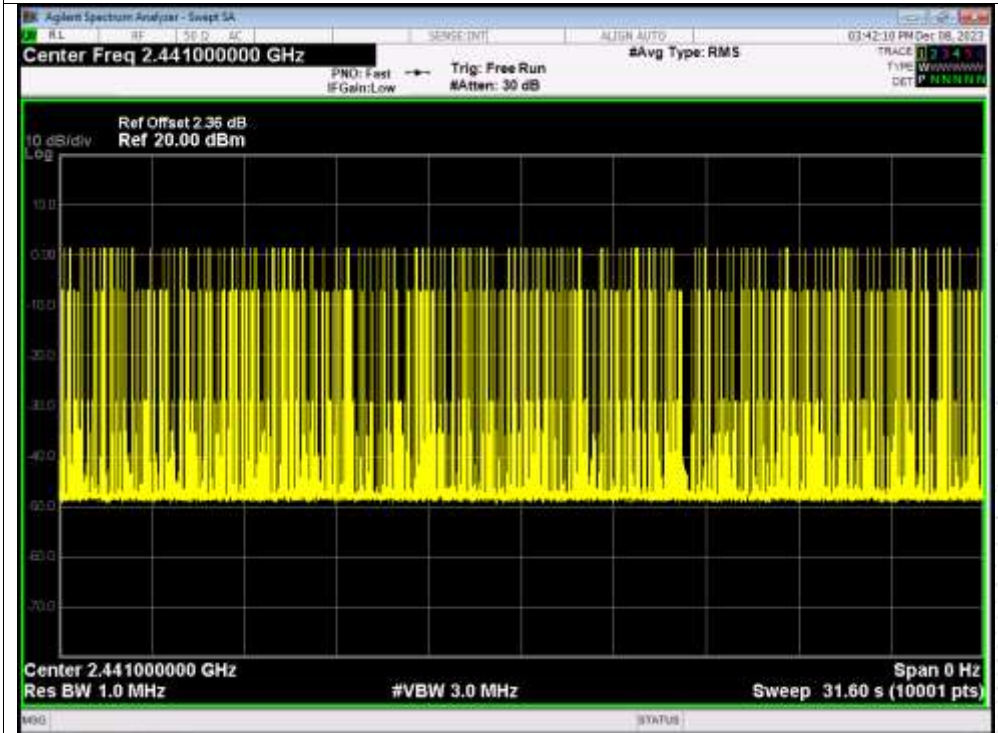

Dwell NVNT 1-DH3 2441MHz Accumulated



SHENZHEN



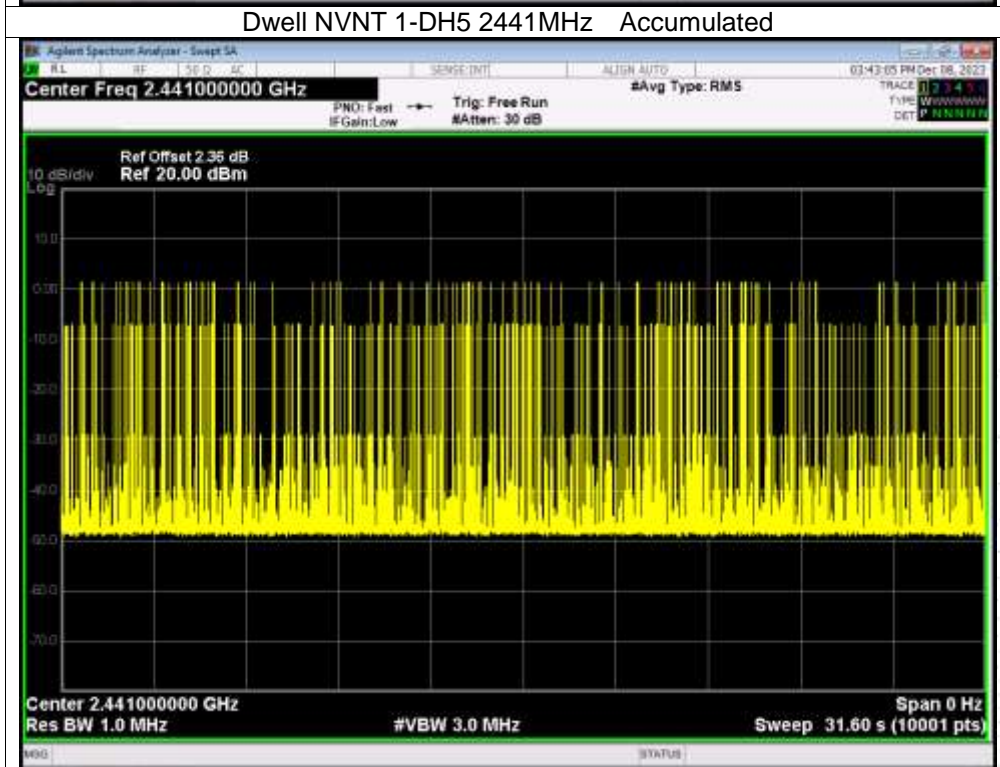
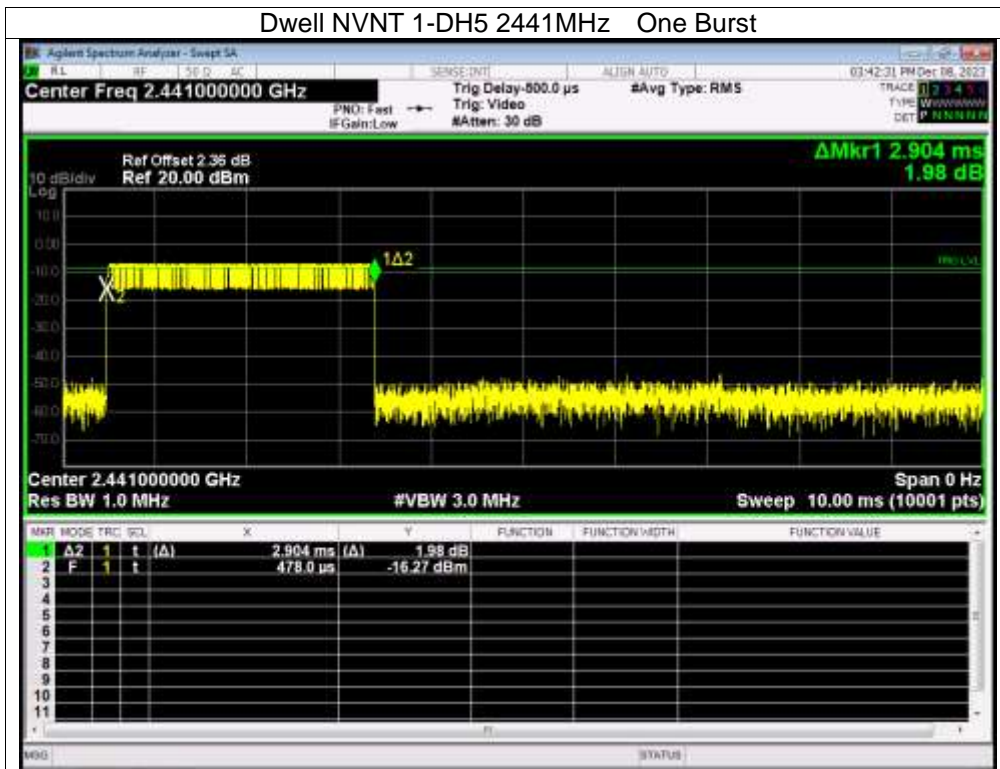



Dwell NVNT 2-DH1 2441MHz One Burst

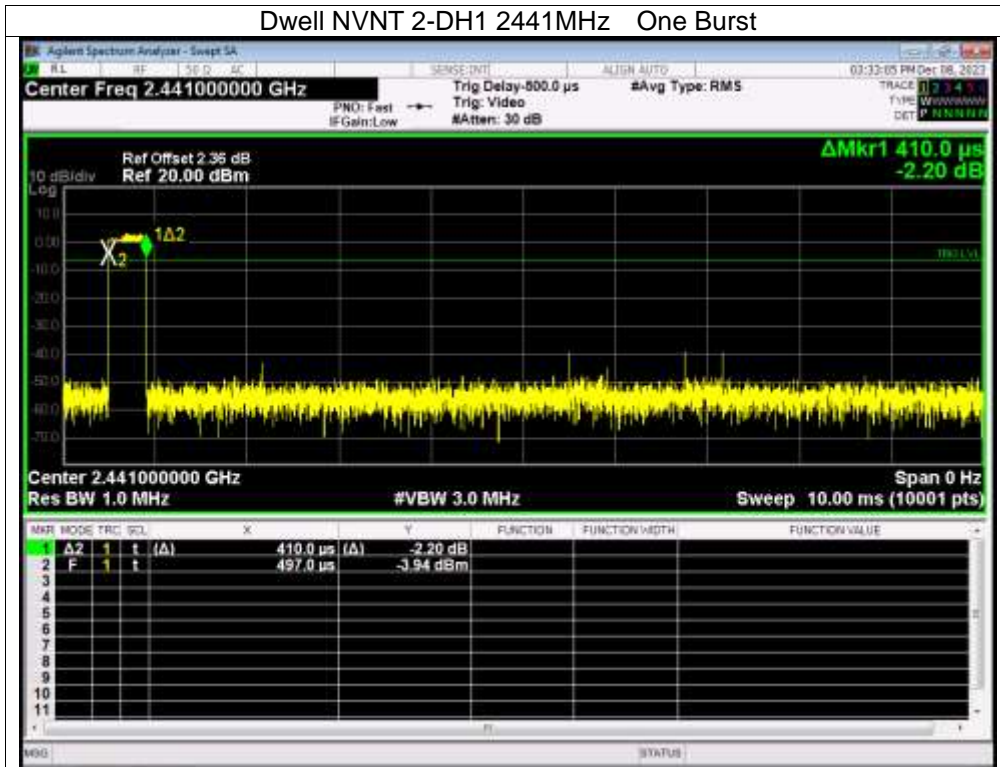

Dwell NVNT 2-DH1 2441MHz Accumulated

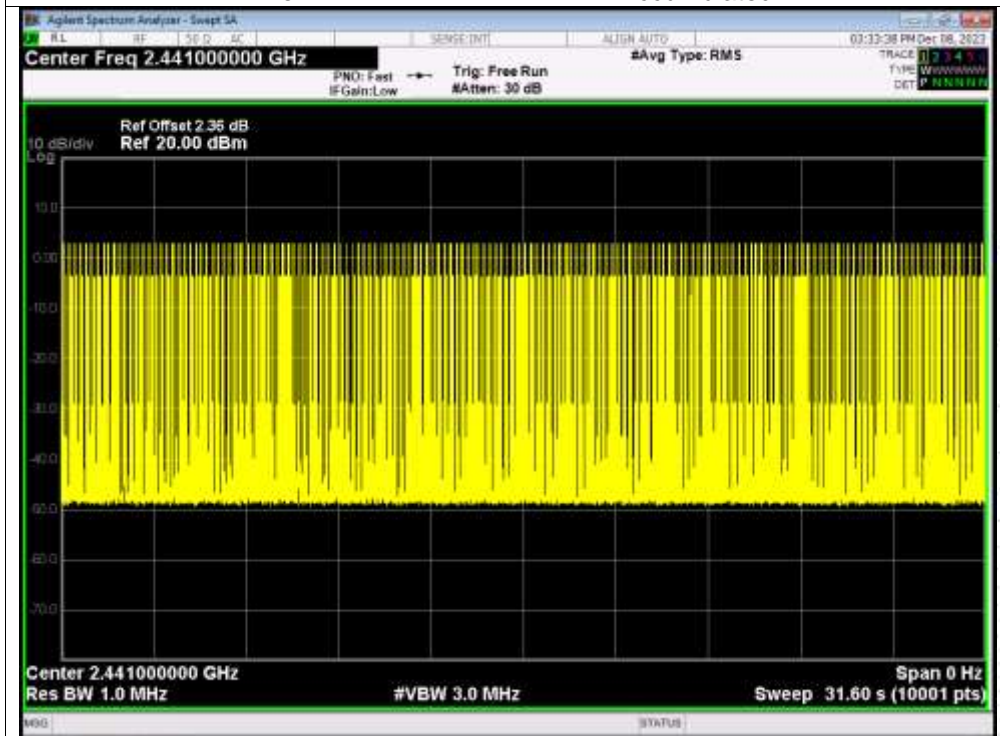

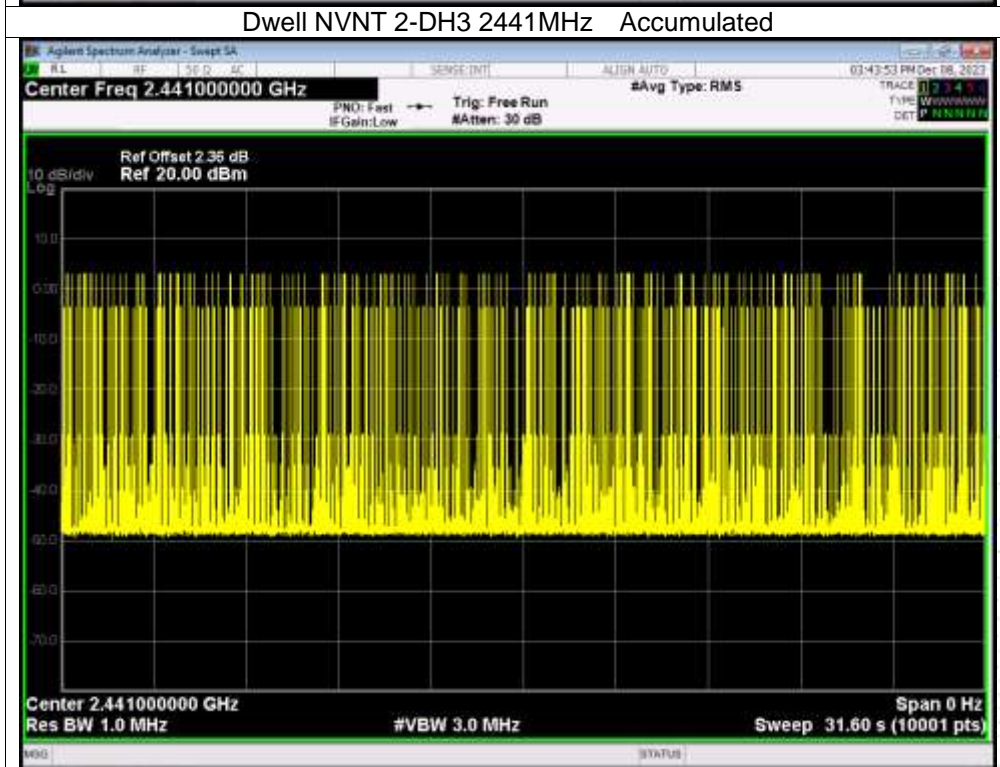
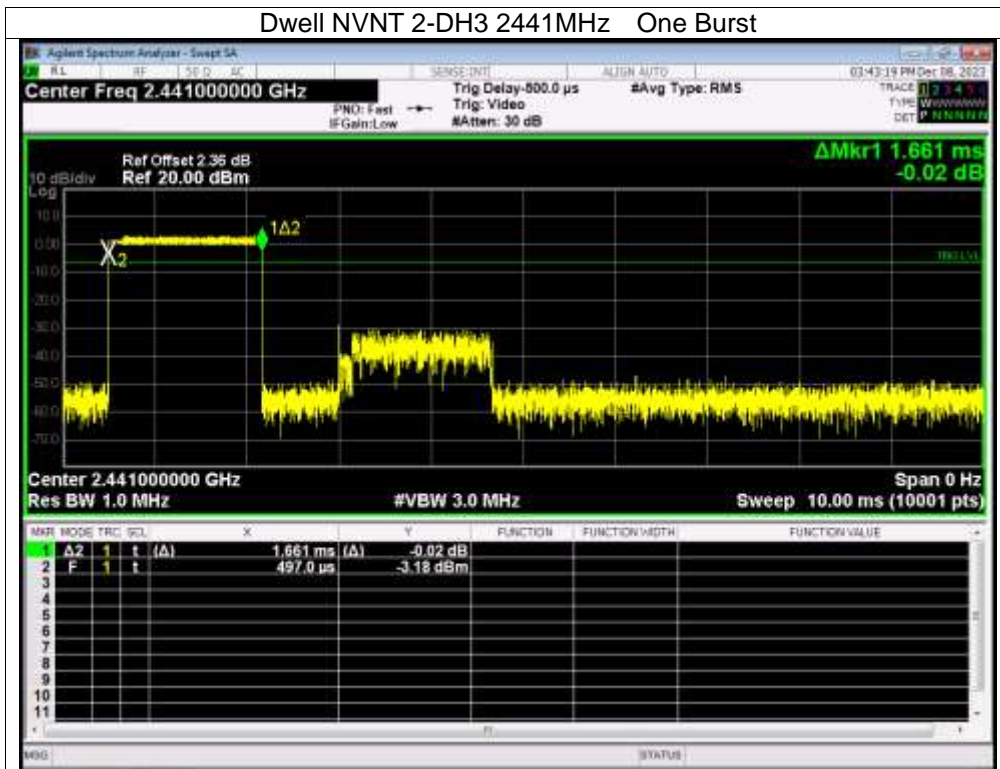
 BCTC  
 BCTC  
 PPR  
 Report

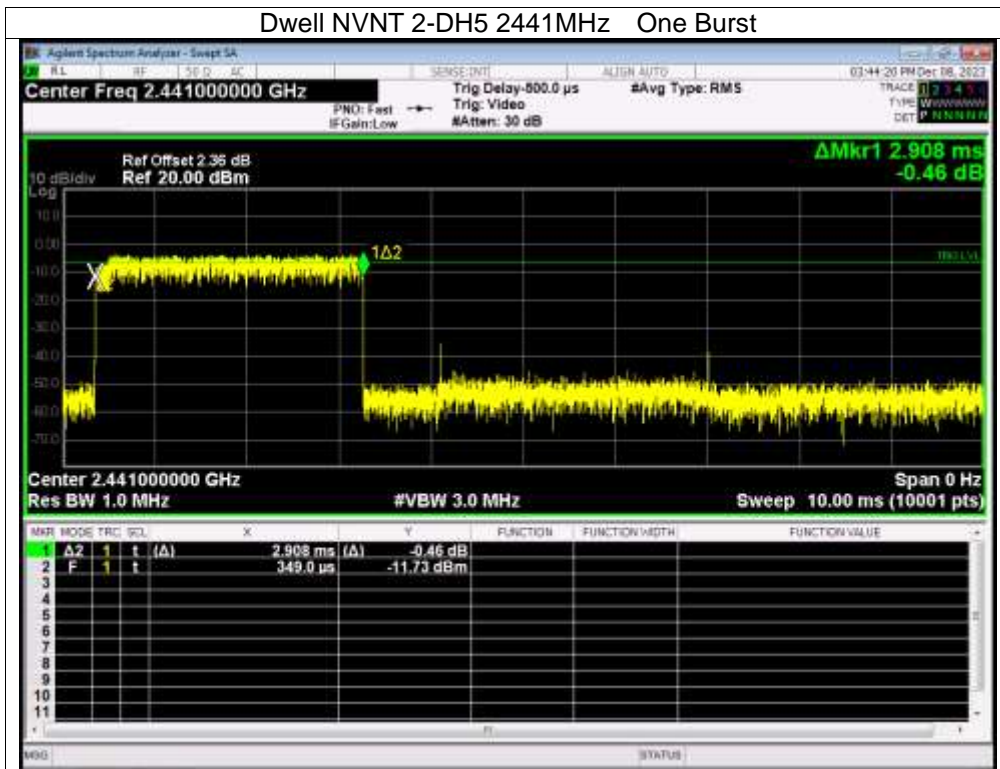

Dwell NVNT 2-DH5 2441MHz One Burst

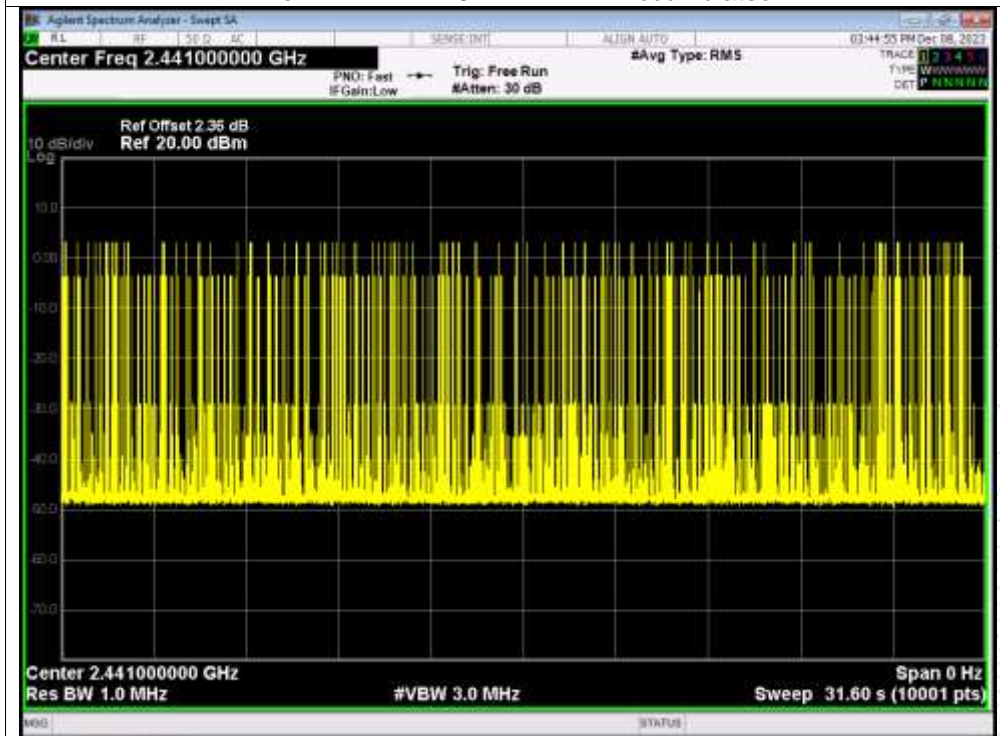

Dwell NVNT 2-DH5 2441MHz Accumulated





Dwell NVNT 3-DH1 2441MHz One Burst

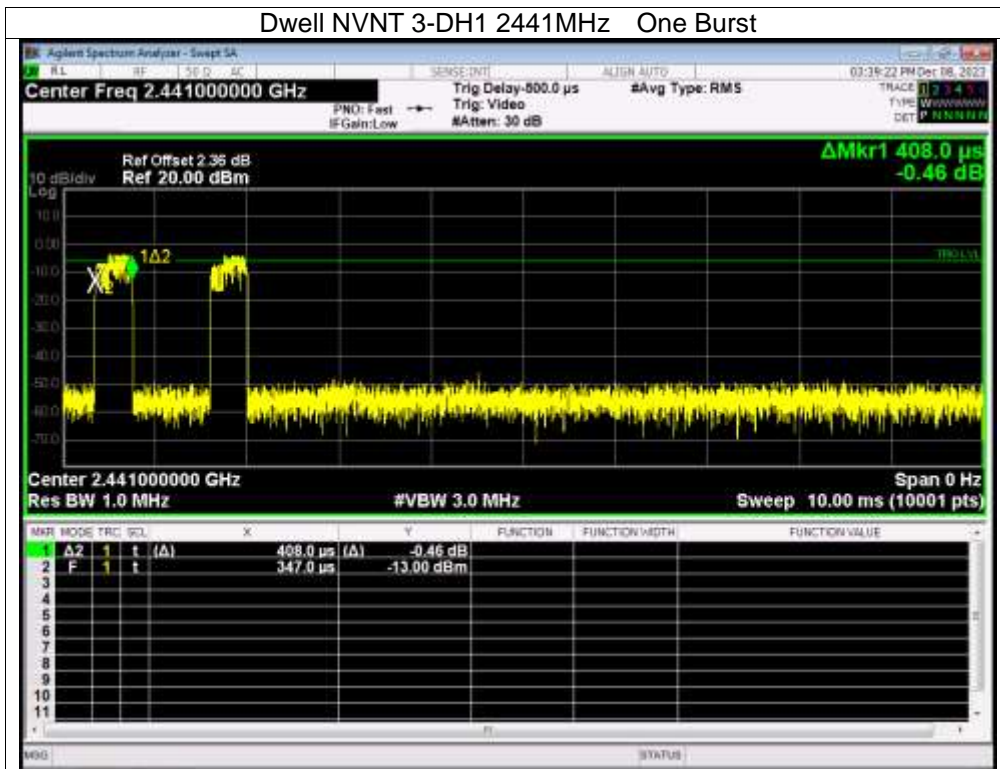

Dwell NVNT 3-DH1 2441MHz Accumulated

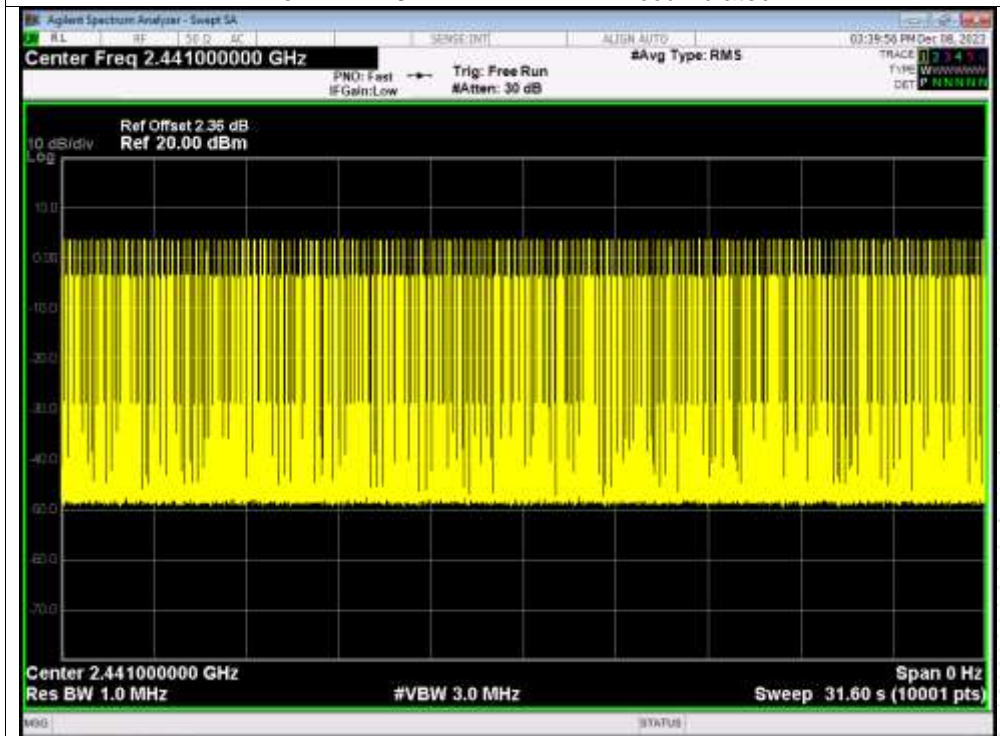

CO., LTD

Dwell NVNT 3-DH3 2441MHz One Burst

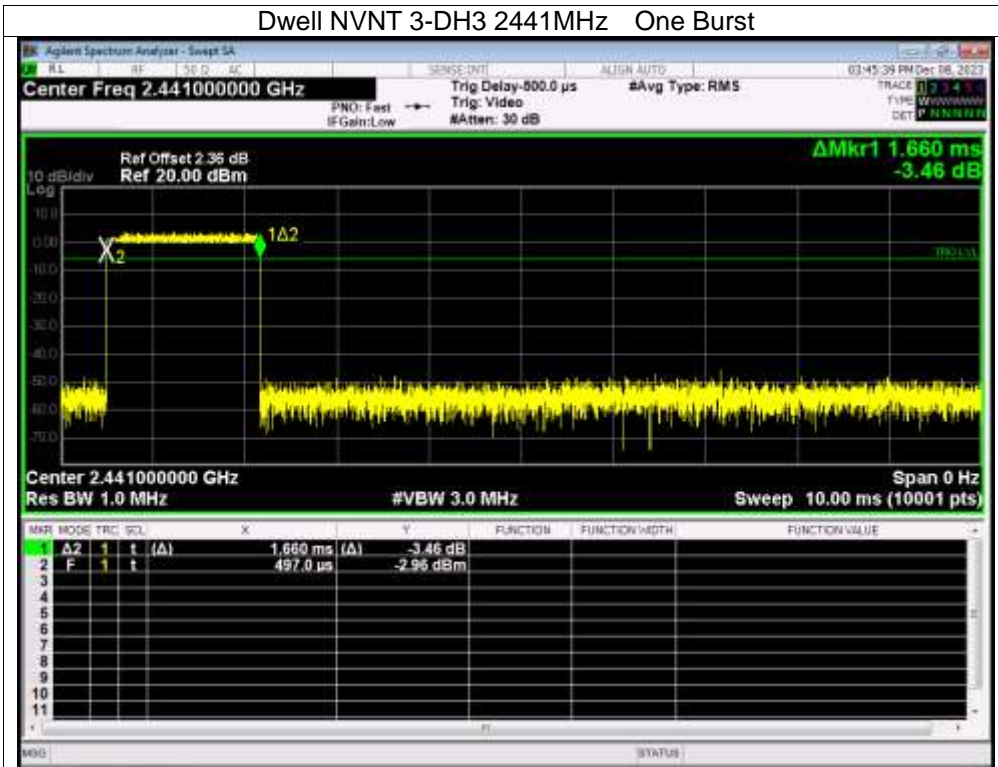

Dwell NVNT 3-DH3 2441MHz Accumulated

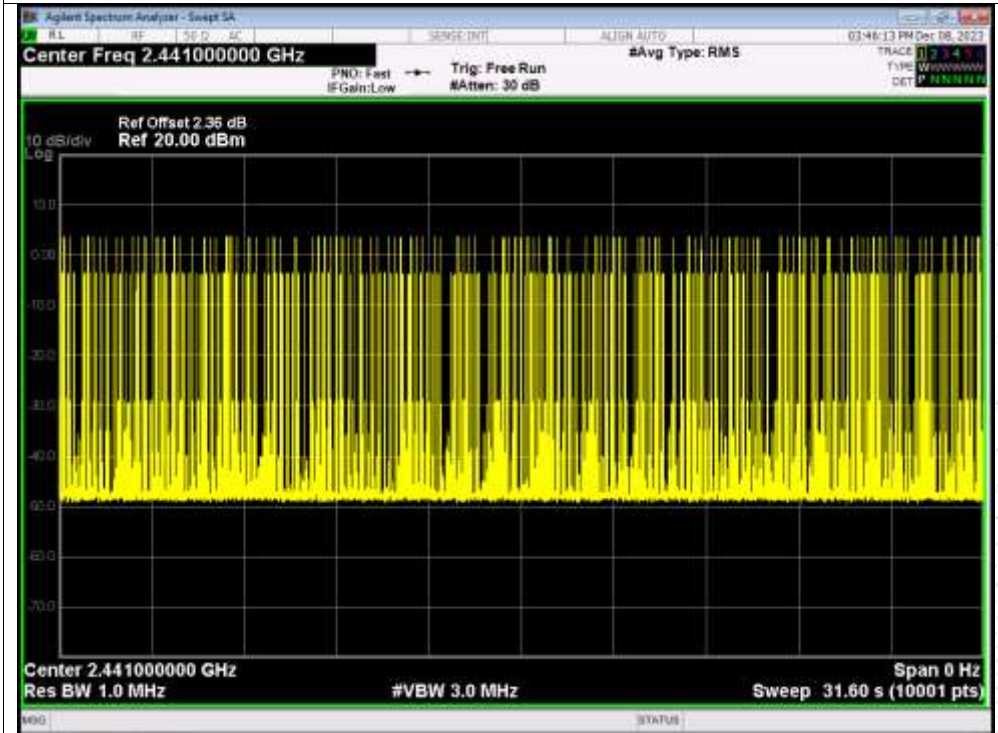



Dwell NVNT 3-DH5 2441MHz One Burst

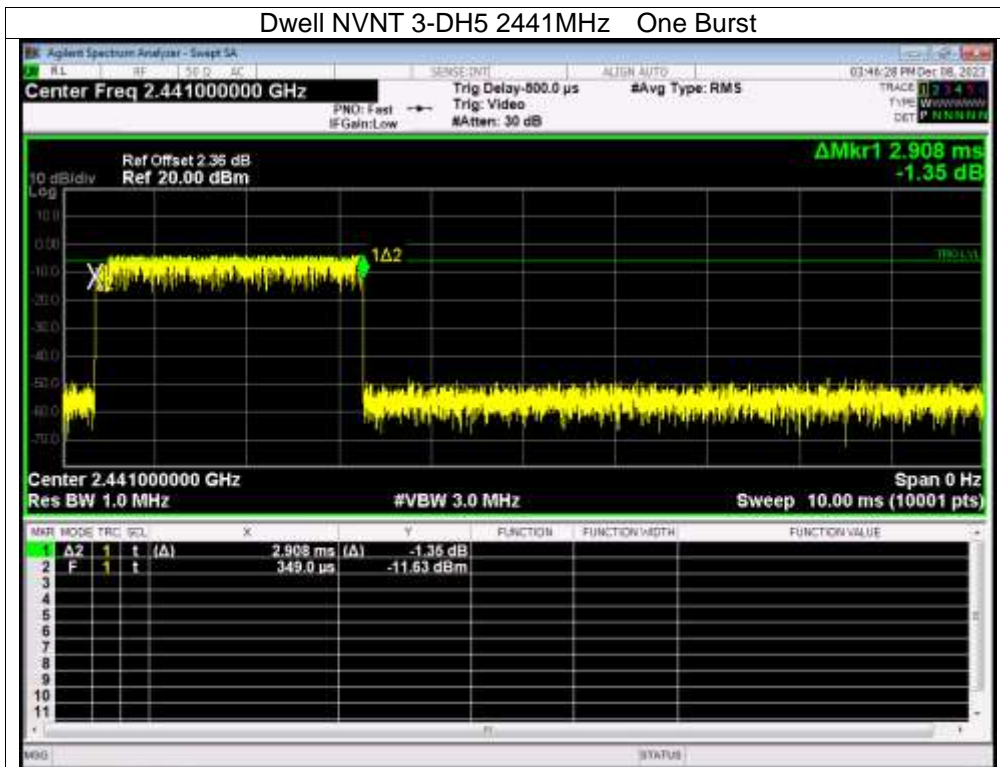

Dwell NVNT 3-DH5 2441MHz Accumulated

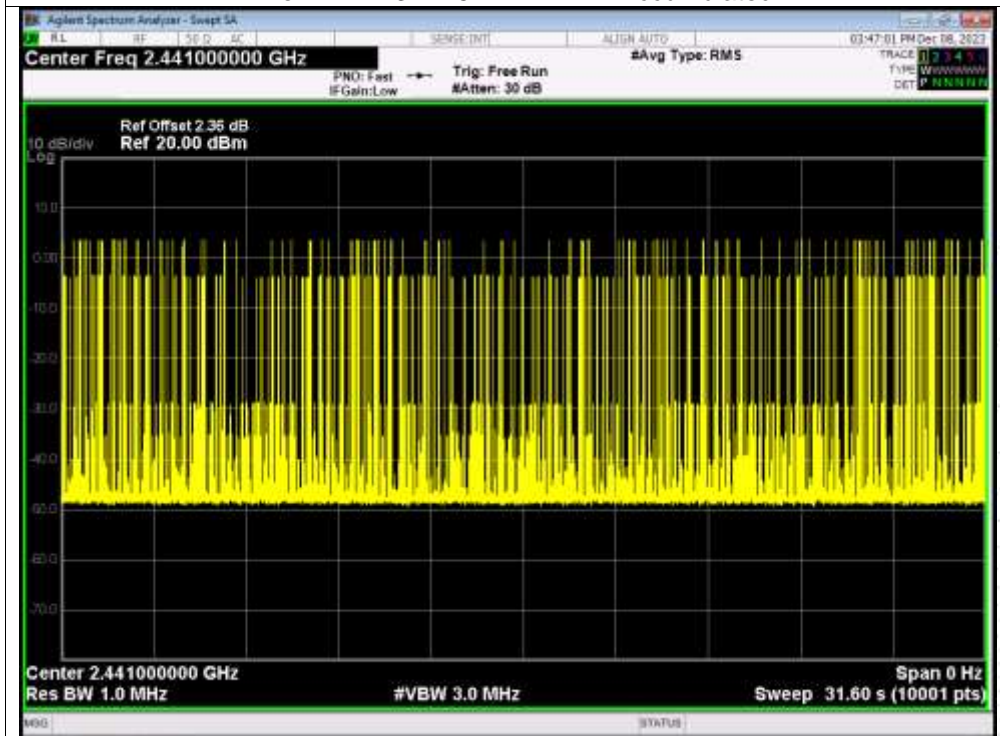

## 15. Antenna Requirement

### 15.1 Limit

15.203 requirement: For intentional device, according to 15.203: an intentional radiator shall be designed to ensure that no antenna other than that furnished by the responsible party shall be used with the device.

### 15.2 Test Result

The EUT antenna is PCB antenna, fulfill the requirement of this section.

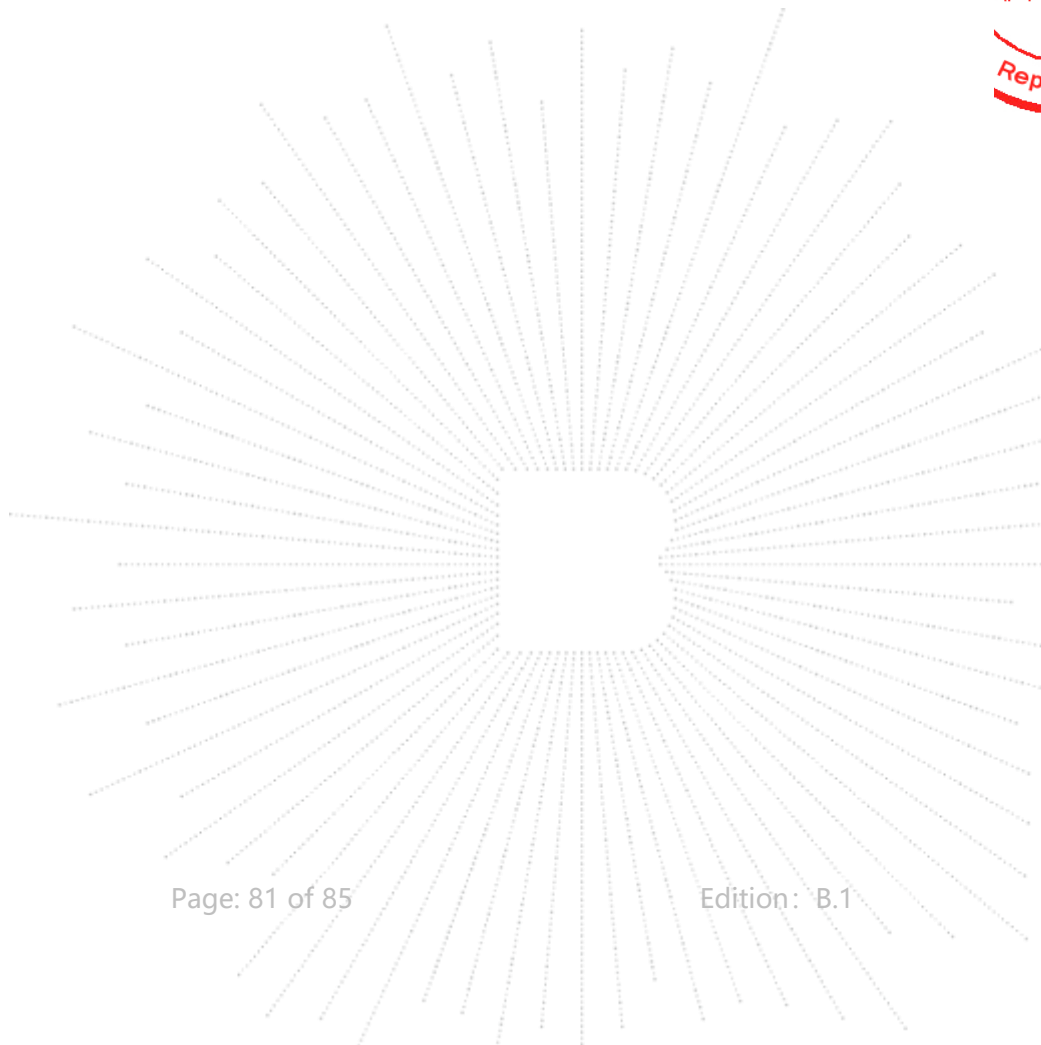

### 16. EUT Photographs

EUT Photo



NOTE: Appendix-Photographs Of EUT Constructional Details

### 17. EUT Test Setup Photographs

Conducted emissions



TEST  
FOR  
OVER  
seal



Radiated Measurement Photos

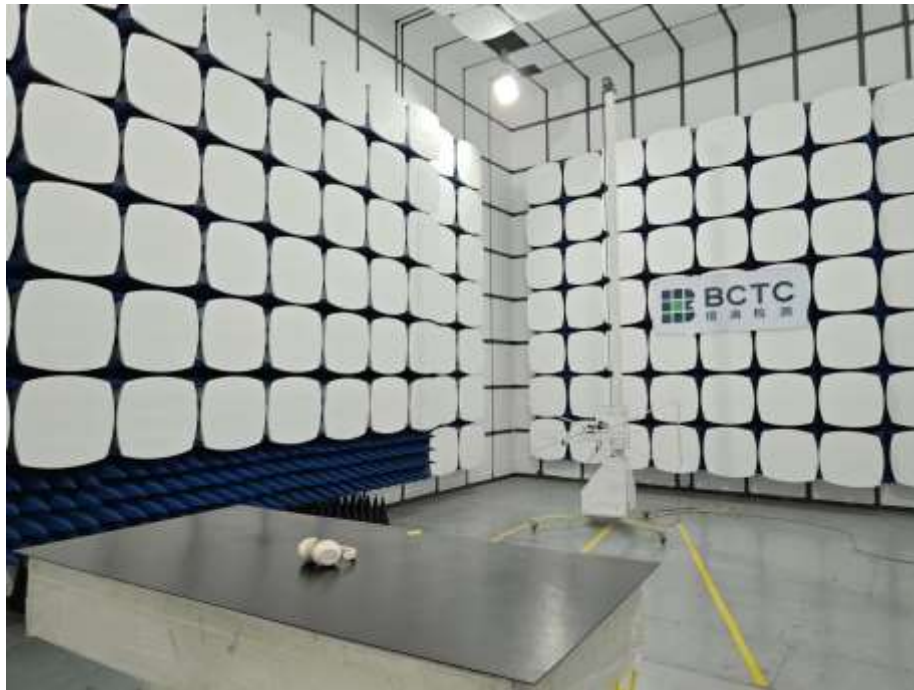



**STATEMENT**

1. The equipment lists are traceable to the national reference standards.
2. The test report can not be partially copied unless prior written approval is issued from our lab.
3. The test report is invalid without the "special seal for inspection and testing".
4. The test report is invalid without the signature of the approver.
5. The test process and test result is only related to the Unit Under Test.
6. Sample information is provided by the client and the laboratory is not responsible for its authenticity.
7. The quality system of our laboratory is in accordance with ISO/IEC17025.
8. If there is any objection to this test report, the client should inform issuing laboratory within 15 days from the date of receiving test report.

**Address:**

1-2/F., Building B, Pengzhou Industrial Park, No.158, Fuyuan 1st Road, Zhancheng, Fuhai Subdistrict, Bao'an District, Shenzhen, Guangdong, China

TEL: 400-788-9558

P.C.: 518103

FAX: 0755-33229357

Website: <http://www.chnbctc.com>

E-Mail: [bctc@bctc-lab.com.cn](mailto:bctc@bctc-lab.com.cn)

※※※※※ END ※※※※※

CO., LTD.