

Antenna Sample Datasheet

customer:	Dongguan yuanfenglun Technology Co., LTD
entry name:	BK401
Material category:	BT antenna
Antenna Type	PIFA
Antenna Material	PCB
edition:	A0
Date:	2024. 6. 3

Contents

1: Antenna test equipment.....	1
2: Passive test report.....	3
3: Matching circuit.....	4
4: Structural drawing.....	5
5: Antenna diagram.....	5

1: Antenna test equipment

List of meters: Agilent 5071B;



1.1 The principle diagram of the ETS anechoic chamber

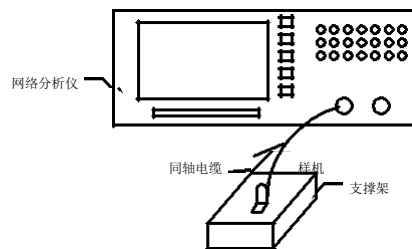

Picture1. Antenna static test connection method

1.2 Pictures of the ETS anechoic chamber



Inside the ETS anechoic chamber



Test Machine

2: Passive test report

2.1: BT antenna S11 parameters

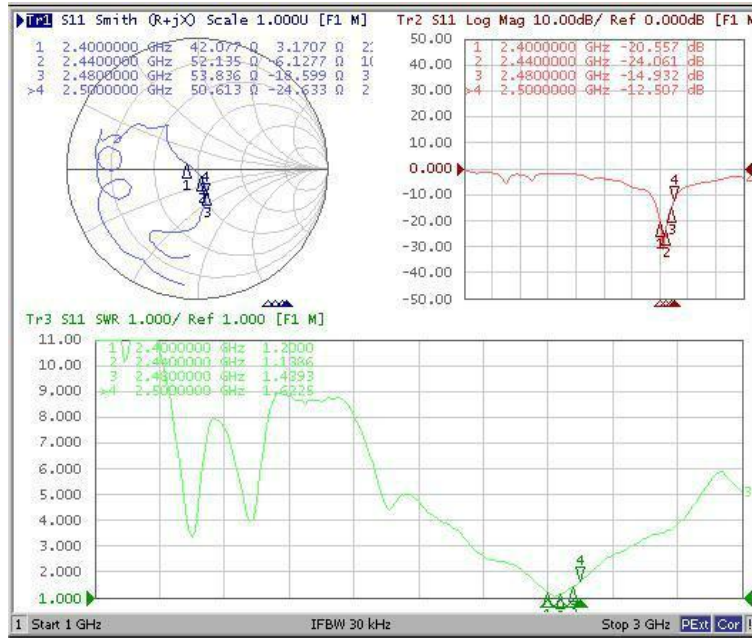

2.2: Passive efficiency of antenna

Freq(MHz)	Gain(dBi)	Efficiency(%)
2400	1.75	55.41
2410	1.85	54.26
2420	2.02	53.32
2430	2.26	50.85
2440	2.36	46.70
2450	2.25	44.55
2460	1.89	42.28
2470	1.76	43.20
2480	1.91	44.42

2.3: Passive pattern of BT antenna

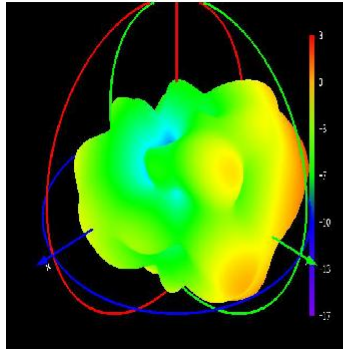

Theta=90 Freq=2440MHz

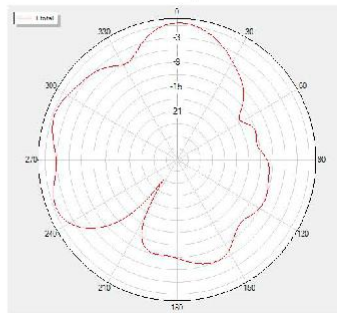

Phi=90 Freq=2440MHz

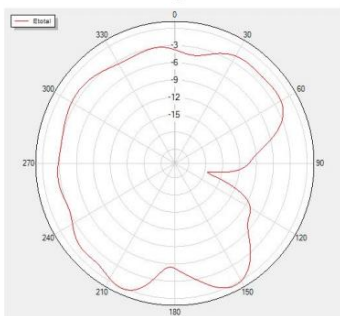

Phi=0 Freq=2440MHz

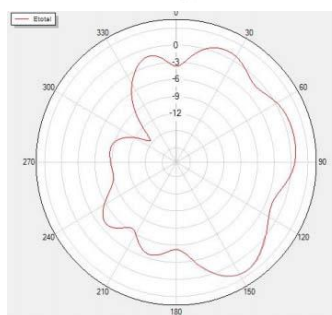

3: Matching circuit

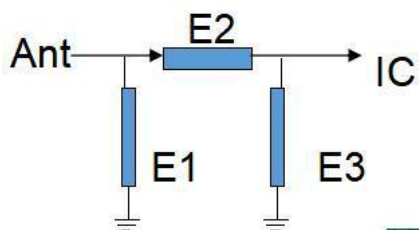

Element	Value
E1	N/C
E2	2.2PF
E3	N/C

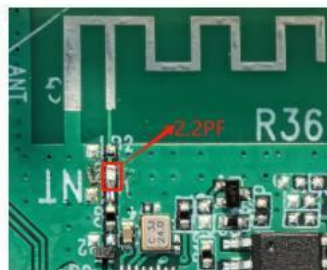

4: tructural drawing

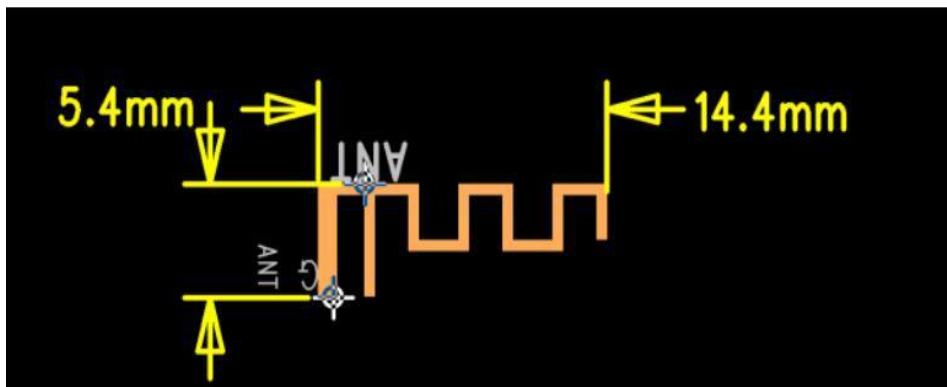

5: Antenna diagram

