

# Guangzhou Xaircraft Technology CO.,LTD

# TEST REPORT



**SCOPE OF WORK**

FCC TESTING–M3SRC4AH

**REPORT NUMBER**

240613075SZN-002

**ISSUE DATE**

26 September 2024

**[REVISED DATE]**

[-----]

**PAGES**

47

**DOCUMENT CONTROL NUMBER**

FCC ID 247\_b

© 2017 INTERTEK

**Guangzhou Xaircraft Technology CO.,LTD**

Application  
For  
Certification

**FCC ID: 2A46G-M3SRC4AH****XAG Smart Remote Controller 4****Model: M3SRC4AH****Brand Name: XAG  
2.4GHz Transceiver**

Report No.: 240613075SZN-002

We hereby certify that the sample of the above item is considered to comply with the requirements of FCC Part 15, Subpart C for Intentional Radiator, mention 47 CFR [10-1-23]

**Prepared and Checked by:****Approved by:****Allen Qin  
Engineer**

---

**Johnny Wang  
Project Engineer  
Date: 26 September 2024**

This report is for the exclusive use of Intertek's Client and is provided pursuant to the agreement between Intertek and its Client. Intertek's responsibility and liability are limited to the terms and conditions of the agreement. Intertek assumes no liability to any party, other than to the Client in accordance with the agreement, for any loss, expense or damage occasioned by the use of this report. Only the Client is authorized to permit copying or distribution of this report and then only in its entirety. Any use of the Intertek name or one of its marks for the sale or advertisement of the tested material, product or service must first be approved in writing by Intertek. The observations and test results in this report are relevant only to the sample tested. This report by itself does not imply that the material, product, or service is or has ever been under an Intertek certification program.

**Intertek Testing Service Shenzhen Ltd. Longhua Branch**

101, 201, Building B, No. 308 Wuhe Avenue, Zhangkengjing Community, GuanHu Subdistrict, LongHua District, Shenzhen.

Tel: (86 755) 8601 6288 Fax: (86 755) 8601 6751

## MEASUREMENT/TECHNICAL REPORT

This report concerns (check one:)      Original Grant       Class II Change

Equipment Type: DSS - Part 15 Spread Spectrum Transmitter

---

Deferred grant requested per 47 CFR 0.457(d)(1)(ii)?      Yes       No

If yes, defer until: \_\_\_\_\_  
date

Company Name agrees to notify the Commission by: \_\_\_\_\_  
date

of the intended date of announcement of the product so that the grant can be issued on that date.

---

Transition Rules Request per 15.37?      Yes       No

If no, assumed Part 15, Subpart C for intentional radiator – the new 47 CFR [10-1-23 Edition] provision.

---

Report prepared by:

Allen Qin  
Intertek Testing Services Shenzhen Ltd. Longhua Branch  
101, 201, Building B, No. 308 Wuhe Avenue, Zhangkengjing  
Community, GuanHu Subdistrict, LongHua District, Shenzhen.  
Tel: (86 755) 8601 6288 Fax: (86 755) 8601 6661

## Table of Contents

|             |   |           |
|-------------|---|-----------|
| <b>1.0</b>  | <b><u>Summary of Test Results</u></b>             | <b>4</b>  |
| <b>2.0</b>  | <b><u>General Description</u></b>                 | <b>5</b>  |
| 2.1         | Product Description                               | 5         |
| 2.2         | Related Submittal(s) Grants                       | 5         |
| 2.3         | Test Methodology                                  | 5         |
| 2.4         | Test Facility                                     | 5         |
| <b>3.0</b>  | <b><u>System Test Configuration</u></b>           | <b>6</b>  |
| 3.1         | Justification                                     | 6         |
| 3.2         | EUT Exercising Software                           | 6         |
| 3.3         | Special Accessories                               | 6         |
| 3.4         | Equipment Modification                            | 6         |
| 3.5         | Measurement Uncertainty                           | 7         |
| 3.6         | Support Equipment List and Description            | 7         |
| <b>4.0</b>  | <b><u>Test Results</u></b>                        | <b>8</b>  |
| 4.1         | Radiated Test Result                              | 8         |
| 4.1.1       | Field Strength Calculation                        | 9         |
| 4.1.2       | Radiated Emission Configuration Photograph        | 10        |
| 4.1.3       | Radiated Emission                                 | 10        |
| 4.1.4       | Transmitter Spurious Emissions (Radiated)         | 13        |
| 4.2         | Conducted Emission at Mains Terminal              | 17        |
| 4.2.1       | Conducted Emission Configuration Photograph       | 17        |
| 4.2.2       | Conducted Emissions                               | 17        |
| 4.3         | Peak Power  | 20        |
| 4.4         | 20dB Bandwidth                                    | 23        |
| 4.5         | Channel Number (Number of Hopping Frequencies)    | 25        |
| 4.6         | Channel Separation (Carrier Frequency Separation) | 28        |
| 4.7         | Dwell Time (Time of Occupancy)                    | 30        |
| 4.8         | Band Edge   | 36        |
| 4.9         | Transmitter Spurious Emission (Conducted)         | 39        |
| <b>5.0</b>  | <b><u>Equipment Photographs</u></b>               | <b>43</b> |
| <b>6.0</b>  | <b><u>Product Labelling</u></b>                   | <b>43</b> |
| <b>7.0</b>  | <b><u>Technical Specifications</u></b>            | <b>43</b> |
| <b>8.0</b>  | <b><u>Instruction Manual</u></b>                  | <b>43</b> |
| <b>9.0</b>  | <b><u>Miscellaneous Information</u></b>           | <b>44</b> |
| 9.1         | Discussion of Pulse Desensitization               | 44        |
| 9.2         | Calculation of Average Factor                     | 44        |
| 9.3         | Emissions Test Procedures                         | 45        |
| <b>10.0</b> | <b><u>Test Equipment List</u></b>                 | <b>47</b> |

**1.0 Summary of Test Results**

Applicant: Guangzhou Xaircraft Technology CO.,LTD

Address: Block C, No.115, Gaopu Road, Tianhe District, Guangzhou City, Guangdong, P.R.China

Manufacturer: Guangzhou Xaircraft Technology CO.,LTD

Address: Block C, No.115, Gaopu Road, Tianhe District, Guangzhou City, Guangdong, P.R.China

**Model: M3SRC4AH**

**FCC ID: 2A46G-M3SRC4AH**

| TEST                                   | REFERENCE                             | RESULTS |
|--|---------------------------------------|---------|
| Max. Output power / Max. e.i.r.p.      | FCC 15.247(b)(1)                      | Pass    |
| 20dB Bandwidth                         | FCC 15.247(a)(1)                      | Pass    |
| Channel Separation                     | FCC 15.247(a)(1)                      | Pass    |
| Channel Number                         | FCC 15.247(a)(1) (iii)                | Pass    |
| Dwell Time                             | FCC 15.247(a)(1)(iii)                 | Pass    |
| Out of Band Antenna Conducted Emission | FCC 15.247(d)                         | Pass    |
| Radiated Emission in Restricted Bands  | FCC 15.247(d), FCC 15.209, FCC 15.205 | Pass    |
| Band Edge                              | FCC 15.247(d), FCC 15.209, FCC 15.205 | Pass    |
| AC Conducted Emission                  | FCC 15.209                            | Pass    |

Notes:

1. The EUT uses an Integral Antenna which in accordance to Section 15.203 is considered sufficient to comply with the provisions of this section.

## 2.0 General Description

### 2.1 Product Description

The equipment under test (EUT) is a XAG Smart Remote Controller 4 with Bluetooth 5.0 (single-mode) function operating in 2402-2480MHz, 2.4G WIFI function operating in 2412-2462MHz. The EUT is powered by DC 3.65 V from rechargeable battery. For more detail information pls. refer to the user manual.

Bluetooth Version: 5.0

Antenna Type: Internal antenna

Antenna Gain: 2.13 dBi (This information is provided by manufacturer, and the manufacturer is responsible for the authenticity of the provided information.)

Modulation Type: GFSK

For electronic filing, the brief circuit description is saved with filename: descri.pdf.

### 2.2 Related Submittal(s) Grants

This is an application for certification of transceiver for the XAG Smart Remote Controller 4 which has Bluetooth EDR function.

For the BT BLE function was tested and demonstrated in report 240613075SZN-001.

For the 2.4GHz WIFI function was tested and demonstrated in report 240613075SZN-003.

For another 2.4GHz WIFI function was certificated in FCC ID: 2A46G-WM101A.

For the 5.8GHz WIFI function was certificated in FCC ID: 2A46G-WM101A.

For the GSM/WCDMA/LTE function was certificated in FCC ID: 2A46G-EG25-G.

### 2.3 Test Methodology

Both AC mains line-conducted and radiated emission measurements were performed according to the procedures in ANSI C63.10 (2013). Radiated emission measurement was performed in semi-anechoic chamber and conducted emission measurement was performed in shield room. For radiated emission measurement, preliminary scans were performed in the semi-anechoic chamber only to determine the worst case modes. All radiated tests were performed at an antenna to EUT distance of 3 meters, unless stated otherwise in the "**Justification Section**" of this Application.

### 2.4 Test Facility

The Semi-anechoic chamber and shielding room used to collect the radiated data and conducted data are **Intertek Testing Services Shenzhen Ltd. Longhua Branch** and located at 101, 201, Building B, No. 308 Wuhe Avenue, Zhangkengjing Community, GuanHu Subdistrict, LongHua District, Shenzhen. This test facility and site measurement data have been fully placed on file with File Number: CN1188.

## 3.0 System Test Configuration

### 3.1 Justification

The system was configured for testing in a typical fashion (as a customer would normally use it), and in the confines as outlined in ANSI C63.10 (2013).

The EUT was powered by DC 3.65 V from rechargeable battery during the test.

All packets DH1, DH3 & DH5 mode in modulation type GFSK were tested and only the worst data was reported in this report.

For maximizing emissions below 30 MHz, the EUT was rotated through 360°, the bottom of the loop antenna was placed 1 meter above the ground, and the antenna polarization was changed. For maximizing emissions, the EUT was rotated through 360°, the antenna height was varied from 1 meter to 4 meters above the ground plane, and the antenna polarization was changed. This step by step procedure for maximizing emissions led to the data reported in Section 4.

The EUT and transmitting antenna was centered on the turntable.

The equipment under test (EUT) was configured for testing in a typical fashion (as a customer would normally use it). The EUT was placed on a turn table, which enabled the engineer to maximize emissions through its placement in the three orthogonal axes.

### 3.2 EUT Exercising Software

The EUT exercise program (provided by client) used during radiated and conducted testing was designed to exercise the various system components in a manner similar to a typical use. The worst-case configuration is used in all specified testing.

The parameters of test software setting:

During the test, Channel and power controlling software provided by the applicant was used to control the operating channel as well as the output power level. The RF output power selection is for the setting of RF output power expected by the application and is going to be fixed on the firmware of the end product.

Test Software: Pandora\_R22.21.4301

### 3.3 Special Accessories

No special accessory attached.

### 3.4 Equipment Modification

Any modifications installed previous to testing by Guangzhou Xaircraft Technology CO.,LTD will be incorporated in each production model sold / leased in the United States.

No modifications were installed by Intertek Testing Services Shenzhen Ltd. Longhua Branch.

### 3.5 Measurement Uncertainty

When determining the test conclusion, the Measurement Uncertainty of test has been considered.

### 3.6 Support Equipment List and Description

| Description                          | Manufacturer | Model No.   |
|--------------------------------------|--------------|---|
| USB Cable<br>(Provided by Applicant) | N/A          | unshielded, 100cm   |
| Adaptor<br>(Provided by Intertek)    | /            | Model: GS-W30A0936<br>Input: 100-240V~50/60Hz 0.8A,<br>Output: DC 5V/3A, 9V/3A, 12V/2.5A,<br>15V/2A, 20V/1.5A |



## 4.0 Test Results

Data is included worst-case configuration (the configuration which resulted in the highest emission levels).

### 4.1 Radiated Test Results

A sample calculation, configuration photographs and data tables of the emissions are included.

The Diagram below shows the test setup, which is utilized to make these measurements.

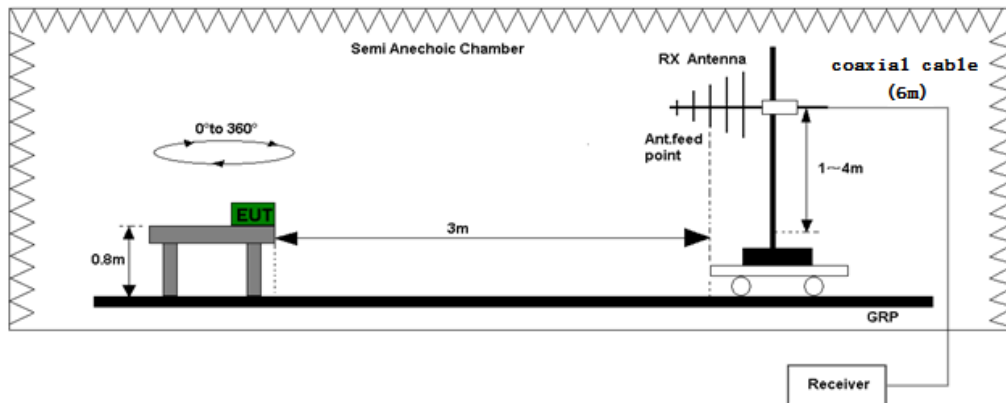

Test set-up of radiated disturbance (Up to 1GHz)

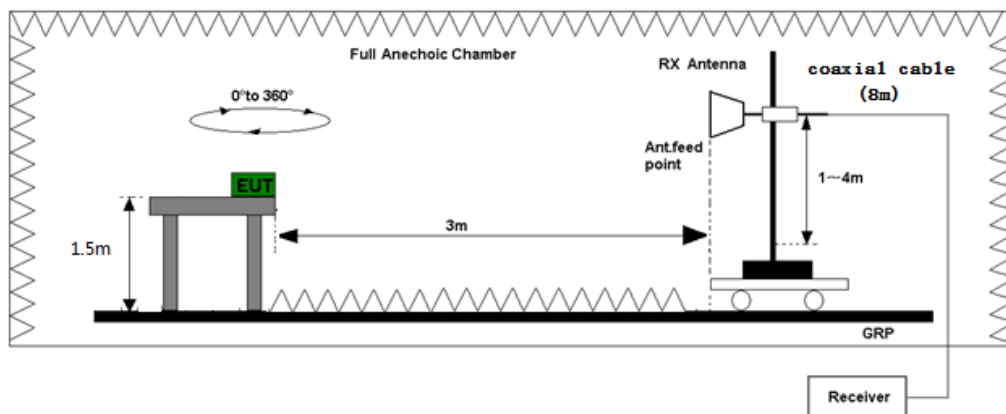

Test set-up of radiated disturbance (Above 1GHz)

Radiated emission measurements were performed from 9 KHz to tenth harmonic or 40GHz. The EUT for testing is arranged on a styrene turntable. If some peripherals apply to the EUT, the peripherals will be connected to EUT and the whole system. During the test, all cables were arranged to produce worst-case emissions. The signal is maximized through rotation. The height of antenna and polarization is changing constantly for exploring for maximum signal level. The height of antenna can be up to 4 meters and down to 1 meter.

#### 4.1.1 Field Strength Calculation

The field strength is calculated by adding the reading on the Spectrum Analyzer to the factors associated with preamplifiers (if any), antennas, cables, pulse desensitization and average factors (when specified limit is in average and measurements are made with peak detectors). A sample calculation is included below.

$$FS = RA + AF + CF - AG + PD + AV$$

Where

- FS = Field Strength in dB $\mu$ V/m
- RA = Receiver Amplitude (including preamplifier) in dB $\mu$ V
- CF = Cable Attenuation Factor in dB
- AF = Antenna Factor in dB/m
- AG = Amplifier Gain in dB
- PD = Pulse Desensitization in dB
- AV = Average Factor in -dB

In the radiated emission table which follows, the reading shown on the data table may reflect the preamplifier gain. An example of the calculations, where the reading does not reflect the preamplifier gain, follows:

$$FS = RA + AF + CF - AG + PD + AV$$

Assume a receiver reading of 62.0 dB $\mu$ V is obtained. The antenna factor of 7.4 dB/m and cable factor of 1.6 dB is added. The amplifier gain of 29 dB is subtracted. The pulse desensitization factor of the spectrum analyzer was 0 dB, and the resultant average factor was -10 dB. The net field strength for comparison to the appropriate emission limit is 32 dB $\mu$ V/m. This value in dB $\mu$ V/m was converted to its corresponding level in  $\mu$ V/m.

RA = 62.0 dB $\mu$ V  
 AF = 7.4 dB/m  
 CF = 1.6 dB  
 AG = 29.0 dB  
 PD = 0 dB  
 AV = -10 dB

$$FS = 62 + 7.4 + 1.6 - 29 + 0 + (-10) = 32 \text{ dB}\mu\text{V/m}$$

$$\text{Level in } \mu\text{V/m} = \text{Common Antilogarithm} [(32 \text{ dB}\mu\text{V/m})/20] = 39.8 \mu\text{V/m}$$

#### 4.1.2 Radiated Emission Configuration Photograph

For electronic filing, the worst case radiated emission configuration photograph is saved with filename: radiated photos. pdf.

#### 4.1.3 Radiated Emissions- FCC section 15.209

The data on the following page lists the significant emission frequencies, the limit and the margin of compliance. Numbers with a minus sign are below the limit.

Worst Case Radiated Emission

at 38.083333 MHz

Judgement: Passed by 3.9 dB

#### **TEST PERSONNEL:**

*Sign on file*

Allen Qin, Engineer  
*Typed/Printed Name*

22 July 2024  
*Date*

Applicant: Guangzhou Xaircraft Technology CO.,LTD

Date of Test: 22 July 2024

Model:M3SRC4AH

Sample: 1/1

Worst-case operating Mode: Simulation transmission

Modulation type: GFSK

ANT Polarity: Horizontal

FCC Part 15

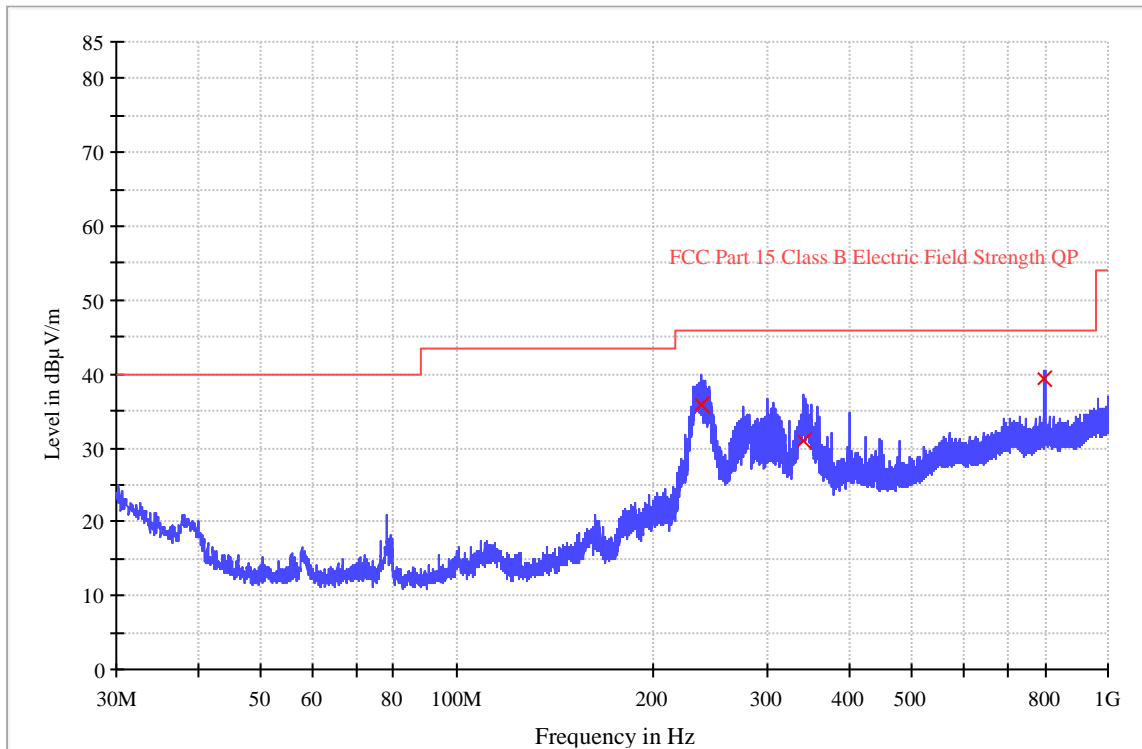

| Frequency (MHz) | Quasi Peak (dBµV/m) | Meas. Time (ms) | Bandwidth (kHz) | Polarization | Corr. (dB/m) | Margin - QPK (dB) | Limit - QPK (dBµV/m) |
|-----------------|---------------------|-----------------|-----------------|--------------|--------------|-------------------|----------------------|
| 237.968000      | 35.9                | 1000.0          | 120.000         | H            | 18.5         | 10.1              | 46.0                 |
| 341.628667      | 30.9                | 1000.0          | 120.000         | H            | 22.3         | 15.1              | 46.0                 |
| 799.986000      | 39.5                | 1000.0          | 120.000         | H            | 32.2         | 6.5               | 46.0                 |

Remark:

1. Corr. (dB/m) = Antenna Factor (dB/m) + Cable Loss (dB)
2. Quasi Peak (dBµV/m) = Corr. (dB/m) + Read Level (dBµV)
3. Margin (dB) = Limit Line (dBµV/m) – Level (dBµV/m)

Applicant: Guangzhou Xaircraft Technology CO.,LTD  
 Date of Test: 22 July 2024  
 Model: M3SRC4AH  
 Sample: 1/1  
 Worst-case operating Mode: Simulation transmission  
 Modulation type: GFSK

ANT Polarity: Vertical

FCC Part 15

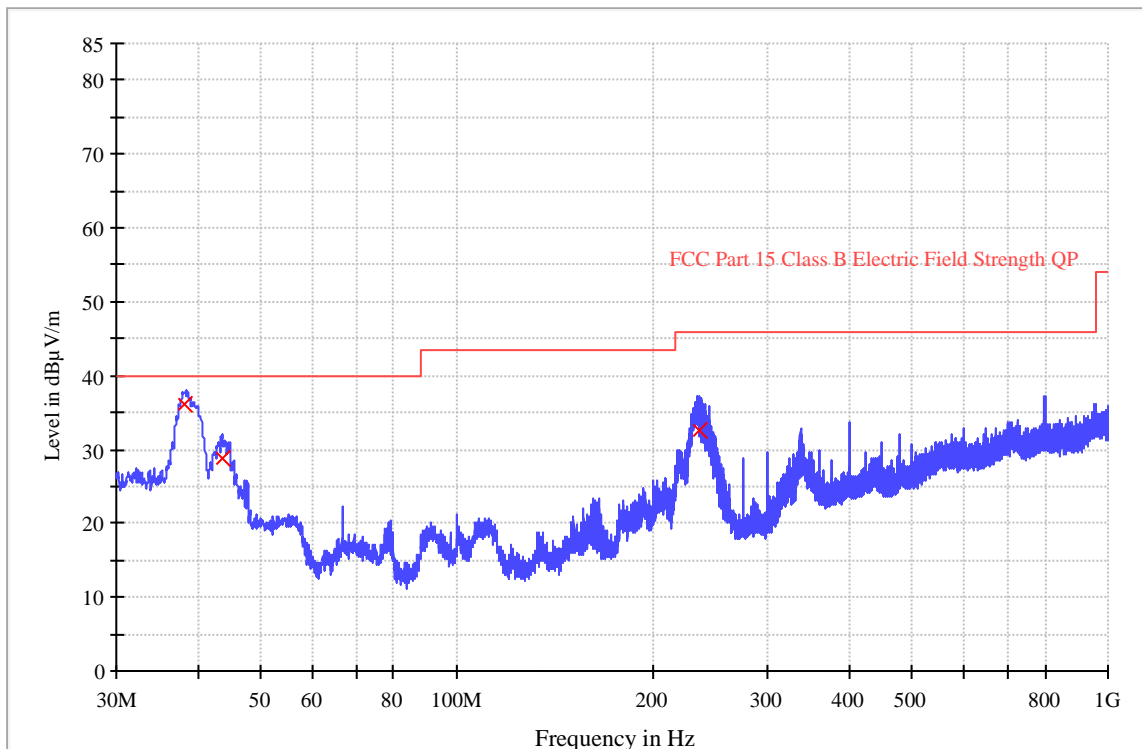

| Frequency (MHz) | Quasi Peak (dBµV/m) | Meas. Time (ms) | Bandwidth (kHz) | Polarization | Corr. (dB/m) | Margin - QPK (dB) | Limit - QPK (dBµV/m) |
|-----------------|---------------------|-----------------|-----------------|--------------|--------------|-------------------|----------------------|
| 38.083333       | 36.1                | 1000.0          | 120.000         | V            | 17.6         | 3.9               | 40.0                 |
| 43.612333       | 28.9                | 1000.0          | 120.000         | V            | 15.0         | 11.1              | 40.0                 |
| 235.963333      | 32.6                | 1000.0          | 120.000         | V            | 18.3         | 13.4              | 46.0                 |

Remark:

1. Corr. (dB/m) = Antenna Factor (dB/m) + Cable Loss (dB)
2. Quasi Peak (dBµV/m) = Corr. (dB/m) + Read Level (dBµV)
3. Margin (dB) = Limit Line (dBµV/m) – Level (dBµV/m)

#### 4.1.4 Transmitter Spurious Emissions (Radiated) - FCC section 15.209

The data on the following page lists the significant emission frequencies, the limit and the margin of compliance. Numbers with a minus sign are below the limit.

Worst Case Radiated Emission

at 7323.000 MHz

Judgement: Passed by 20.6 dB

**TEST PERSONNEL:**

*Sign on file*

Allen Qin, Engineer  
*Typed/Printed Name*

22 July 2024  
*Date*

Applicant: Guangzhou Xaircraft Technology CO.,LTD  
 Date of Test: 22 July 2024  
 Model: M3SRC4AH  
 Sample: 1/1  
 Worst-case operating Mode: Transmit (2402MHz)  
 Modulation type: GFSK

Table 1

**Radiated Emissions**

(2402MHz)

| Polarization | Frequency (MHz) | Reading (dBμV) | Pre-Amp Gain (dB) | Antenna Factor (dB/m) | Net at 3m (dBμV/m) | Peak Limit at 3m (dBμV/m) | Margin (dB) |
|--------------|-----------------|----------------|-------------------|-----------------------|--------------------|---------------------------|-------------|
| Horizontal   | **2402.000      | 111.1          | 36.7              | 28.1                  | 102.5              | --                        | --          |
| Horizontal   | *4804.000       | 49.1           | 36.7              | 35.5                  | 47.9               | 74.0                      | -26.1       |

| Polarization | Frequency (MHz) | Reading (dBμV) | Pre-Amp Gain (dB) | Antenna Factor (dB/m) | Average Factor (-dB) | Net at 3m (dBμV/m) | Average Limit at 3m (dBμV/m) | Margin (dB) |
|--------------|-----------------|----------------|-------------------|-----------------------|----------------------|--------------------|------------------------------|-------------|
| Horizontal   | **2402.000      | 111.1          | 36.7              | 28.1                  | 22.5                 | 80.0               | --                           | --          |
| Horizontal   | *4804.000       | 49.1           | 36.7              | 35.5                  | 22.5                 | 25.4               | 54.0                         | -28.6       |

- NOTES:
1. Peak detector is used for the emission measurement.
  2. All measurements were made at 3 meters. Radiated emissions not detected at the 3-meter distance were measured at 0.3-meter and an inverse proportional extrapolation was performed to compare the signal level to the 3-meter limit. No other radiated emissions than those reported were detected at a test distance of 0.3-meter.
  3. Negative value in the margin column shows emission below limit.
  4. Horn antenna used for the emission over 1000MHz.
- \* Emission within the restricted band meets the requirement of section 15.205. The corresponding limit as per 15.209 is based on Quasi peak limit for frequencies below 1000 MHz and average limit for frequencies over 1000 MHz. The radio frequency emissions above 1GHz also meet corresponding 20dB permitted peak limit with a peak detector function.
- \*\* Fundamental emission was measured for determining band-edge compliance of using delta measurement technique.

Applicant: Guangzhou Xaircraft Technology CO.,LTD

Date of Test: 22 July 2024

Model: M3SRC4AH

Sample: 1/1

Worst-case operating Mode: Transmit (2441MHz)

Modulation type: GFSK

Table 2

**Radiated Emissions**

(2441MHz)

| Polarization | Frequency (MHz) | Reading (dB $\mu$ V) | Pre-Amp Gain (dB) | Antenna Factor (dB/m) | Net at 3m (dB $\mu$ V/m) | Peak Limit at 3m (dB $\mu$ V/m) | Margin (dB) |
|--------------|-----------------|----------------------|-------------------|-----------------------|--------------------------|---------------------------------|-------------|
| Horizontal   | *4882.000       | 50.3                 | 36.7              | 35.5                  | 49.1                     | 74.0                            | -24.9       |
| Horizontal   | *7323.000       | 52.3                 | 36.1              | 37.2                  | 53.4                     | 74.0                            | -20.6       |

| Polarization | Frequency (MHz) | Reading (dB $\mu$ V) | Pre-Amp Gain (dB) | Antenna Factor (dB/m) | Average Factor (-dB) | Net at 3m (dB $\mu$ V/m) | Average Limit at 3m (dB $\mu$ V/m) | Margin (dB) |
|--------------|-----------------|----------------------|-------------------|-----------------------|----------------------|--------------------------|------------------------------------|-------------|
| Horizontal   | *4882.000       | 50.3                 | 36.7              | 35.5                  | 22.5                 | 26.6                     | 54.0                               | -27.4       |
| Horizontal   | *7323.000       | 52.3                 | 36.1              | 37.2                  | 22.5                 | 30.9                     | 54.0                               | -23.1       |

- NOTES:
1. Peak detector is used for the emission measurement.
  2. All measurements were made at 3 meters. Radiated emissions not detected at the 3-meter distance were measured at 0.3-meter and an inverse proportional extrapolation was performed to compare the signal level to the 3-meter limit. No other radiated emissions than those reported were detected at a test distance of 0.3-meter.
  3. Negative value in the margin column shows emission below limit.
  4. Horn antenna used for the emission over 1000MHz.
- \* Emission within the restricted band meets the requirement of section 15.205. The corresponding limit as per 15.209 is based on Quasi peak limit for frequencies below 1000 MHz and average limit for frequencies over 1000 MHz. The radio frequency emissions above 1GHz also meet corresponding 20dB permitted peak limit with a peak detector function.



Applicant: Guangzhou Xaircraft Technology CO.,LTD

Date of Test: 22 July 2024

Model: M3SRC4AH

Sample: 1/1

Worst-case operating Mode: Transmit (2480MHz)

Modulation type: GFSK

Table 3

## Radiated Emissions

(2480MHz)

| Polarization | Frequency (MHz) | Reading (dB $\mu$ V) | Pre-Amp Gain (dB) | Antenna Factor (dB/m) | Net at 3m (dB $\mu$ V/m) | Peak Limit at 3m (dB $\mu$ V/m) | Margin (dB) |
|--------------|-----------------|----------------------|-------------------|-----------------------|--------------------------|---------------------------------|-------------|
| Horizontal   | **2480.000      | 107.3                | 36.7              | 28.1                  | 98.7                     | --                              | --          |
| Horizontal   | *4960.000       | 49.0                 | 36.7              | 35.5                  | 47.8                     | 74.0                            | -26.2       |
| Horizontal   | *7440.000       | 50.8                 | 36.1              | 37.2                  | 51.9                     | 74.0                            | -22.1       |

| Polarization | Frequency (MHz) | Reading (dB $\mu$ V) | Pre-Amp Gain (dB) | Antenna Factor (dB/m) | Average Factor (-dB) | Net at 3m (dB $\mu$ V/m) | Average Limit at 3m (dB $\mu$ V/m) | Margin (dB) |
|--------------|-----------------|----------------------|-------------------|-----------------------|----------------------|--------------------------|------------------------------------|-------------|
| Horizontal   | **2480.000      | 107.3                | 36.7              | 28.1                  | 22.5                 | 76.2                     | --                                 | --          |
| Horizontal   | *4960.000       | 49.0                 | 36.7              | 35.5                  | 22.5                 | 25.3                     | 54.0                               | -28.7       |
| Horizontal   | *7440.000       | 50.8                 | 36.1              | 37.2                  | 22.5                 | 29.4                     | 54.0                               | -24.6       |

- NOTES:
1. Peak detector is used for the emission measurement.
  2. All measurements were made at 3 meters. Radiated emissions not detected at the 3-meter distance were measured at 0.3-meter and an inverse proportional extrapolation was performed to compare the signal level to the 3-meter limit. No other radiated emissions than those reported were detected at a test distance of 0.3-meter.
  3. Negative value in the margin column shows emission below limit.
  4. Horn antenna used for the emission over 1000MHz.
- \* Emission within the restricted band meets the requirement of section 15.205. The corresponding limit as per 15.209 is based on Quasi peak limit for frequencies below 1000 MHz and average limit for frequencies over 1000 MHz. The radio frequency emissions above 1GHz also meet corresponding 20dB permitted peak limit with a peak detector function.
- \*\* Fundamental emission was measured for determining band-edge compliance of using delta measurement technique.

## 4.2 Conducted Emission at Mains Terminal

### 4.2.1 Conducted Emissions Configuration Photograph

Block Diagram:

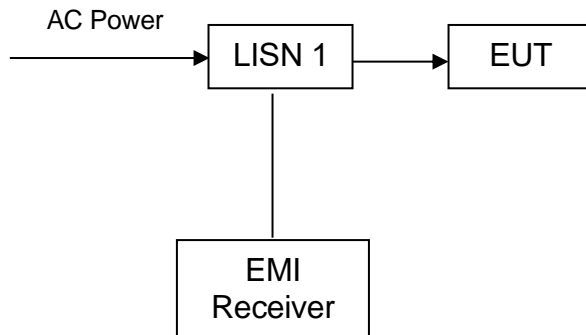

For electronic filing, the worst case conducted emission configuration photograph is saved with filename: conducted photos.pdf.

### 4.2.2 Conducted Emissions

Worst Case Conducted Configuration

at 0.426 MHz

Judgement: Passed by 14.8 dB margin

#### **TEST PERSONNEL:**

*Sign on file*

Allen Qin Engineer  
*Typed/Printed Name*

22 July 2024  
*Date*

Applicant: Guangzhou Xaircraft Technology CO.,LTD  
 Date of Test: 22 July 2024  
 Model: M3SRC4AH  
 Sample: 1/1  
 Worst-case operating Mode: Simulation transmission  
 Modulation type: GFSK  
 Phase: Live

## Conducted Emission Test - FCC

Conducted Emission Test FCC Part 15

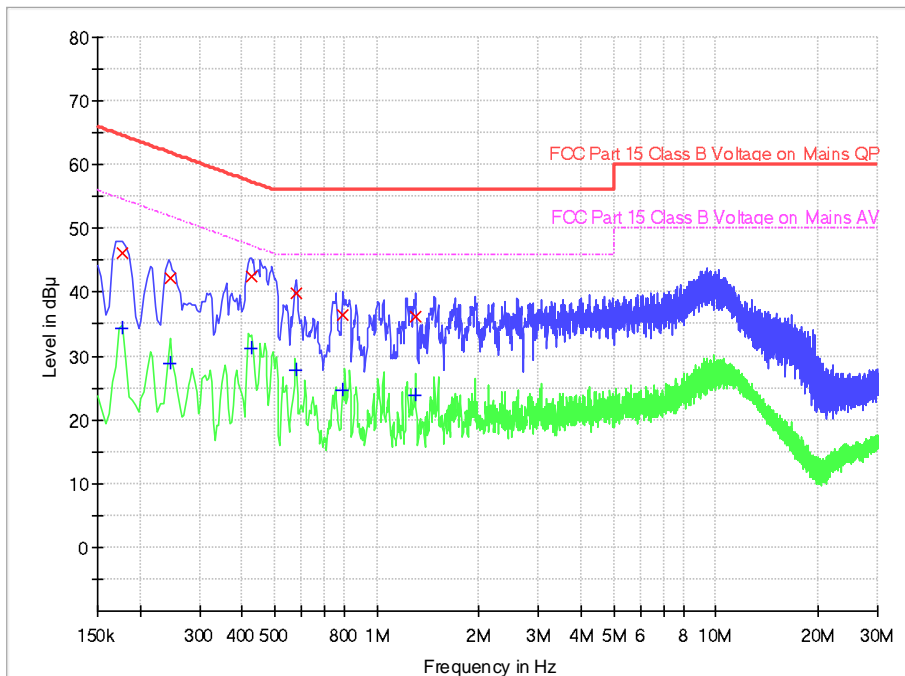

### Result Table QP

| Frequency (MHz) | Quasi Peak (dBμV) | Bandwidth (kHz) | Line | Corr. (dB) | Margin (dB) | Limit (dBμV) |
|-----------------|-------------------|-----------------|------|------------|-------------|--------------|
| 0.178000        | 46.3              | 9.000           | L1   | 9.6        | 18.3        | 64.6         |
| 0.246000        | 42.1              | 9.000           | L1   | 9.6        | 19.8        | 61.9         |
| 0.426000        | 42.5              | 9.000           | L1   | 9.6        | 14.8        | 57.3         |
| 0.578000        | 39.8              | 9.000           | L1   | 9.6        | 16.2        | 56.0         |
| 0.794000        | 36.6              | 9.000           | L1   | 9.6        | 19.4        | 56.0         |
| 1.302000        | 36.1              | 9.000           | L1   | 9.6        | 19.9        | 56.0         |

### Result Table AV

| Frequency (MHz) | Average (dBμV) | Bandwidth (kHz) | Line | Corr. (dB) | Margin (dB) | Limit (dBμV) |
|-----------------|----------------|-----------------|------|------------|-------------|--------------|
| 0.178000        | 34.3           | 9.000           | L1   | 9.6        | 20.3        | 54.6         |
| 0.246000        | 28.9           | 9.000           | L1   | 9.6        | 23.0        | 51.9         |
| 0.426000        | 31.3           | 9.000           | L1   | 9.6        | 16.1        | 47.3         |
| 0.578000        | 27.9           | 9.000           | L1   | 9.6        | 18.1        | 46.0         |
| 0.794000        | 24.5           | 9.000           | L1   | 9.6        | 21.5        | 46.0         |
| 1.302000        | 23.9           | 9.000           | L1   | 9.6        | 22.1        | 46.0         |

Applicant: Guangzhou Xaircraft Technology CO.,LTD  
 Date of Test: 22 July 2024  
 Model: M3SRC4AH  
 Sample: 1/1  
 Worst-case operating Mode: Simulation transmission  
 Modulation type: GFSK  
 Phase: Neutral

## Conducted Emission Test - FCC

Conducted Emission Test FCC Part 15

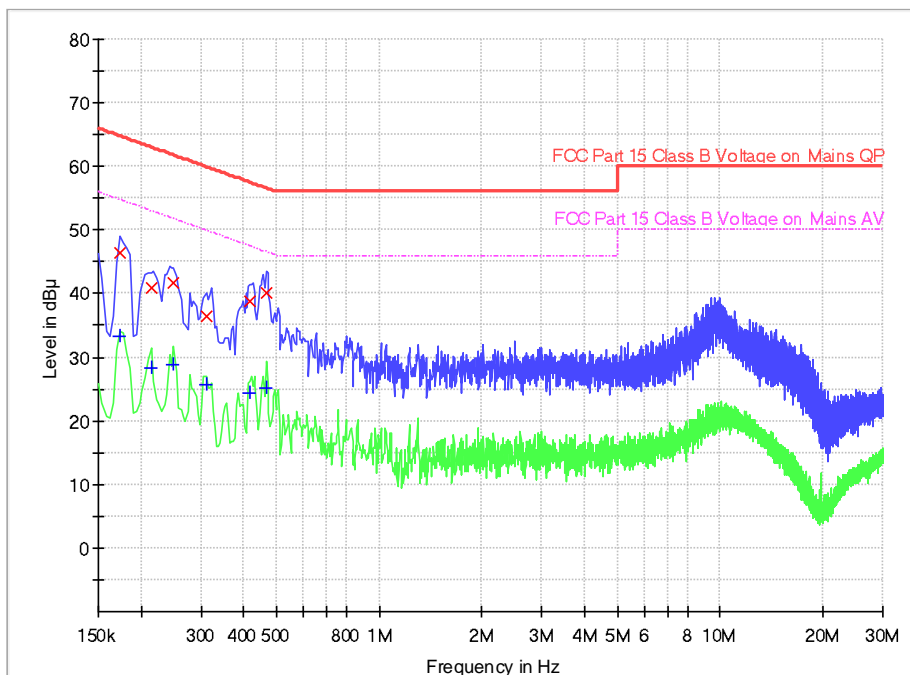

### Result Table QP

| Frequency (MHz) | Quasi Peak (dBμV) | Bandwidth (kHz) | Line | Corr. (dB) | Margin (dB) | Limit (dBμV) |
|-----------------|-------------------|-----------------|------|------------|-------------|--------------|
| 0.174000        | 46.5              | 9.000           | N    | 9.6        | 18.3        | 64.8         |
| 0.214000        | 41.0              | 9.000           | N    | 9.6        | 22.0        | 63.0         |
| 0.250000        | 41.8              | 9.000           | N    | 9.6        | 20.0        | 61.8         |
| 0.310000        | 36.5              | 9.000           | N    | 9.6        | 23.5        | 60.0         |
| 0.418000        | 38.8              | 9.000           | N    | 9.6        | 18.7        | 57.5         |
| 0.466000        | 40.0              | 9.000           | N    | 9.6        | 16.6        | 56.6         |

### Result Table AV

| Frequency (MHz) | Average (dBμV) | Bandwidth (kHz) | Line | Corr. (dB) | Margin (dB) | Limit (dBμV) |
|-----------------|----------------|-----------------|------|------------|-------------|--------------|
| 0.174000        | 33.2           | 9.000           | N    | 9.6        | 21.6        | 54.8         |
| 0.214000        | 28.3           | 9.000           | N    | 9.6        | 24.7        | 53.0         |
| 0.250000        | 29.0           | 9.000           | N    | 9.6        | 22.8        | 51.8         |
| 0.310000        | 25.7           | 9.000           | N    | 9.6        | 24.3        | 50.0         |
| 0.418000        | 24.4           | 9.000           | N    | 9.6        | 23.1        | 47.5         |
| 0.466000        | 25.3           | 9.000           | N    | 9.6        | 21.3        | 46.6         |

## 4.3 Peak Power

Maximum Conducted Output Power at Antenna Terminals, FCC Rules 15.247(b)(1).

The antenna port of the EUT was connected to the input of a spectrum analyzer. The analyzer was set for RBW > 20dB bandwidth and power was read directly in dBm.

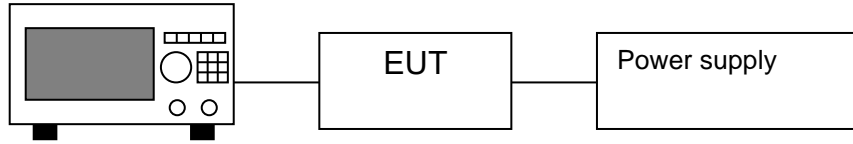

Spectrum Analyzer

For antenna with gains of 6dBi or less, and frequency hopping systems operating in the 2400–2483.5 MHz band may have hopping channel carrier frequencies that are separated by 25 kHz or two-thirds of the 20 dB bandwidth of the hopping channel, whichever is greater, the systems operate with an output power no greater than 125 mW.

| Antenna Gain = 3.32dBi |                 |                                   |                   |
|------------------------|-----------------|-----------------------------------|-------------------|
| Modulation Type        | Frequency (MHz) | Output Power (Peak Reading) (dBm) | Output Power (mW) |
| GFSK                   | 2402            | 7.33                              | 5.41              |
|                        | 2441            | 7.68                              | 5.86              |
|                        | 2480            | 7.60                              | 5.75              |

Cable loss: 0.5 dB External Attenuation: 0 dB

Modulation Type: GFSK

CH00

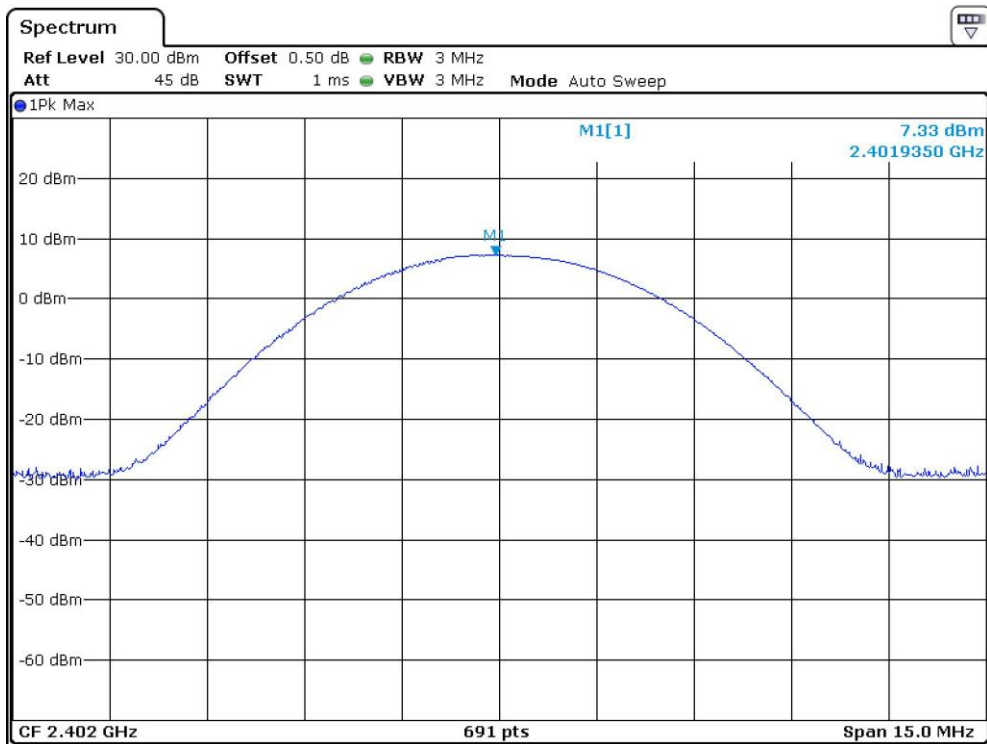

CH39

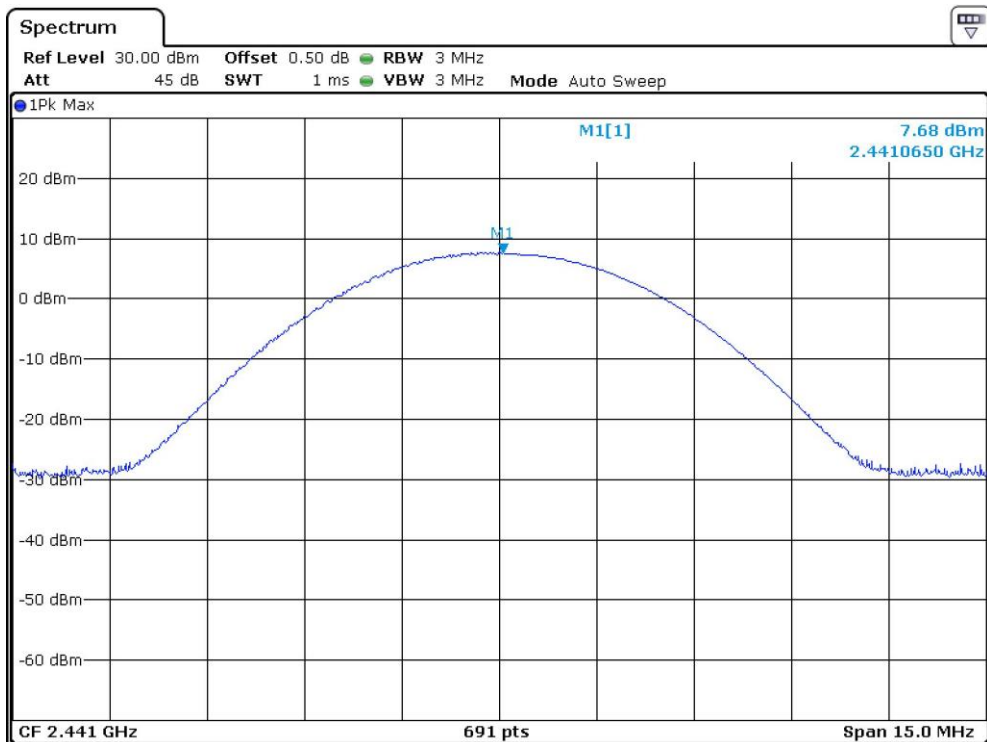

CH78

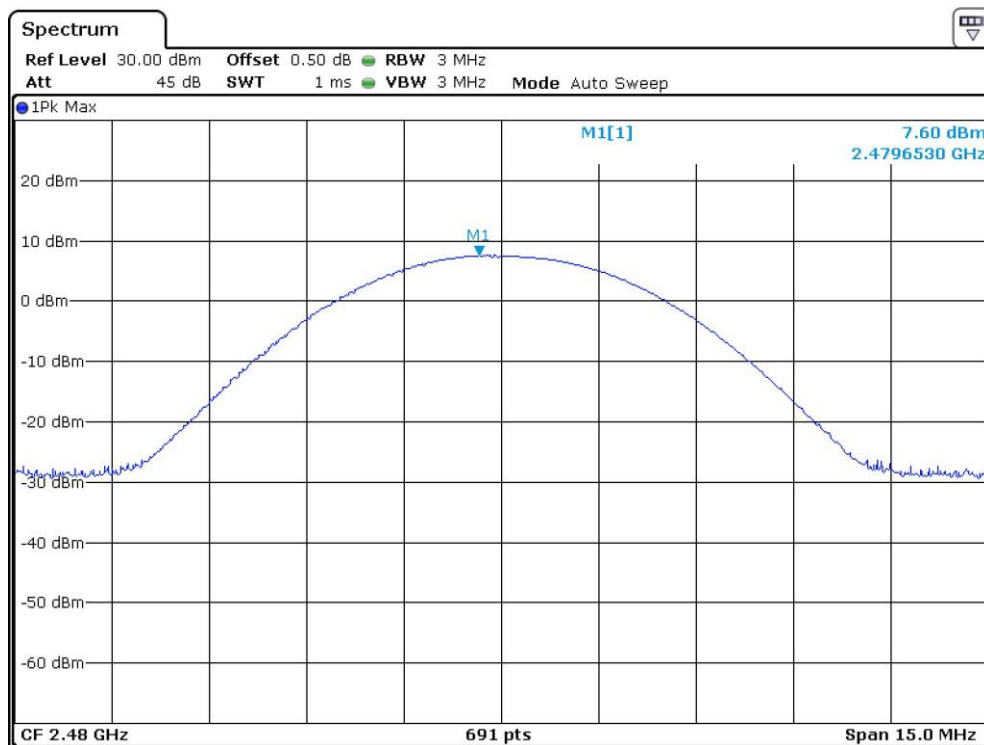

## 4.4 20dB Bandwidth

Maximum 20dB RF Bandwidth, FCC Rule 15.247(a) (1):

The antenna port of the EUT was connected to the input of a spectrum analyzer. Analyzer RBW was chosen so that the display was a result of the hopping channel modulation. For each RF output channel investigated, the spectrum analyzer center frequency was set to the channel carrier. Use the spectrum 20dB down delta function to measure the bandwidth.

Block Diagram:

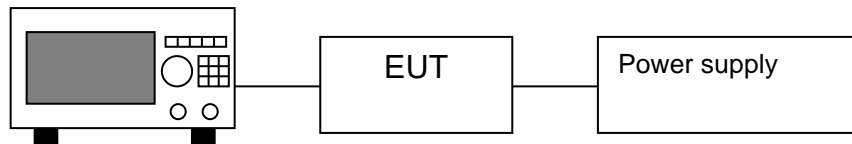

Spectrum Analyzer

| Frequency (MHz) | 20 dB Bandwidth (MHz) |
|-----------------|-----------------------|
| 2402            | 1.012                 |
| 2441            | 1.012                 |
| 2480            | 1.007                 |

Modulation Type: GFSK

CH00

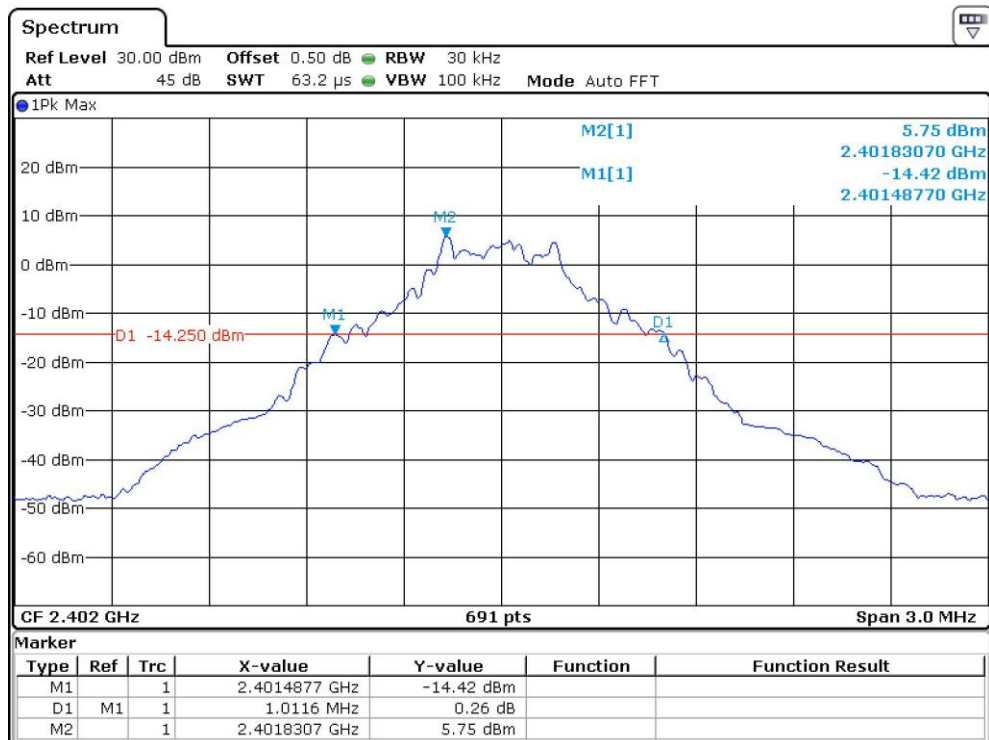



CH39

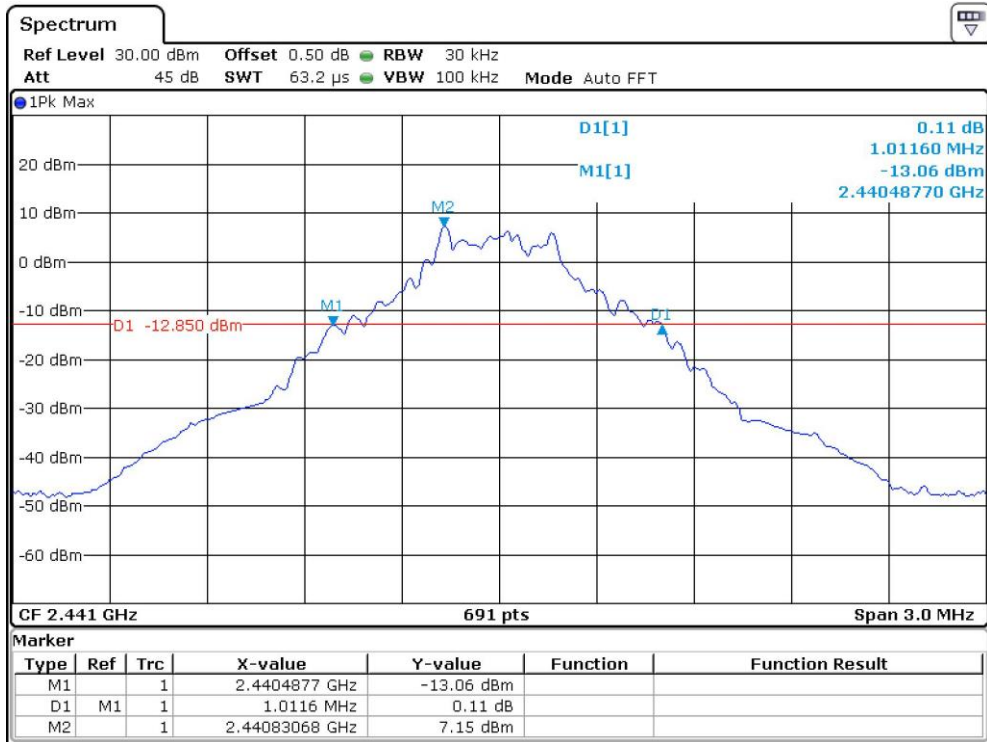

CH78

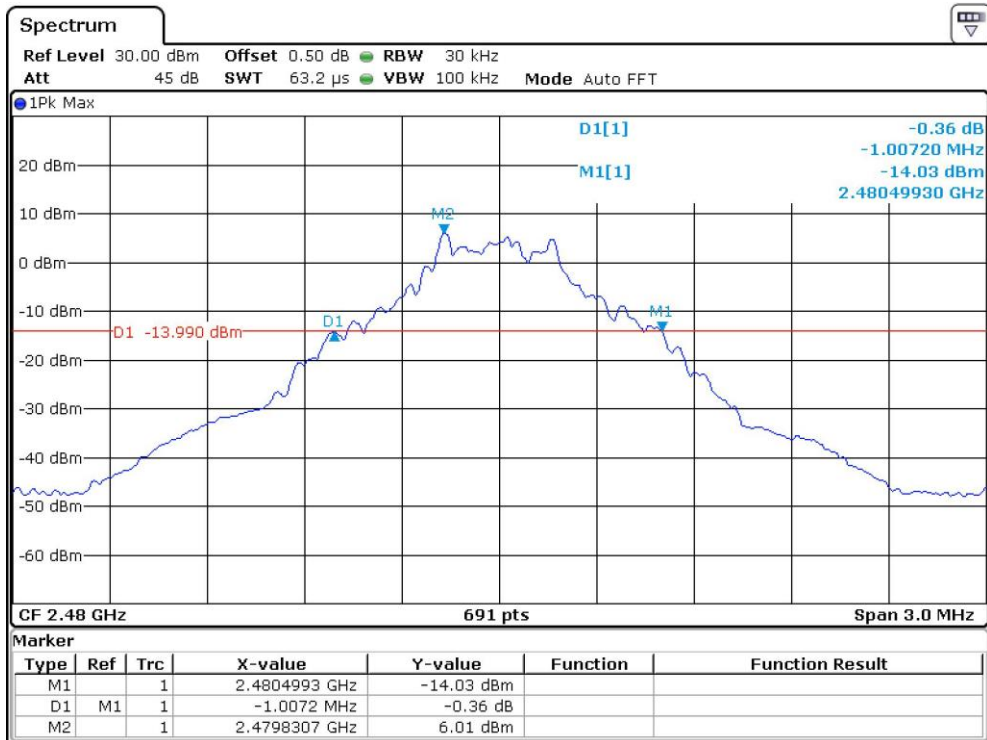

## 4.5 Channel Number (Number of Hopping Frequencies)

Minimum Number of Hopping Frequencies, FCC Rule 15.247(a) (1) (iii):

The RF passband of the EUT was divided into 3 approximately equal bands. With the analyzer set to MAX HOLD readings were taken for 2-3 minutes. The channel peaks so recorded were added together, and the total number compared to the minimum number of channels required in the regulation.

Block Diagram:



Spectrum Analyzer

|                              |    |
|------------------------------|----|
| Number of hopping channels = | 79 |
|------------------------------|----|

Note: In AFH mode, this device operates using 20 channels and it's satisfied the requirement of limit of minimum of 15 hopping channels.

Modulation Type: GFSK

CH00-CH78

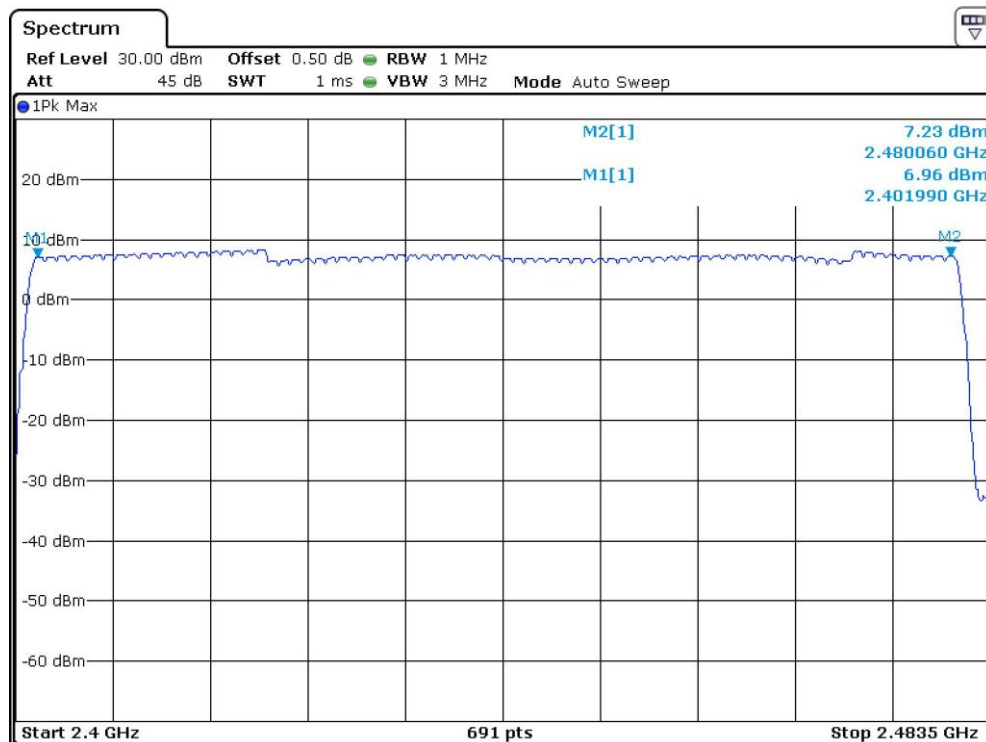

## CH00-CH24

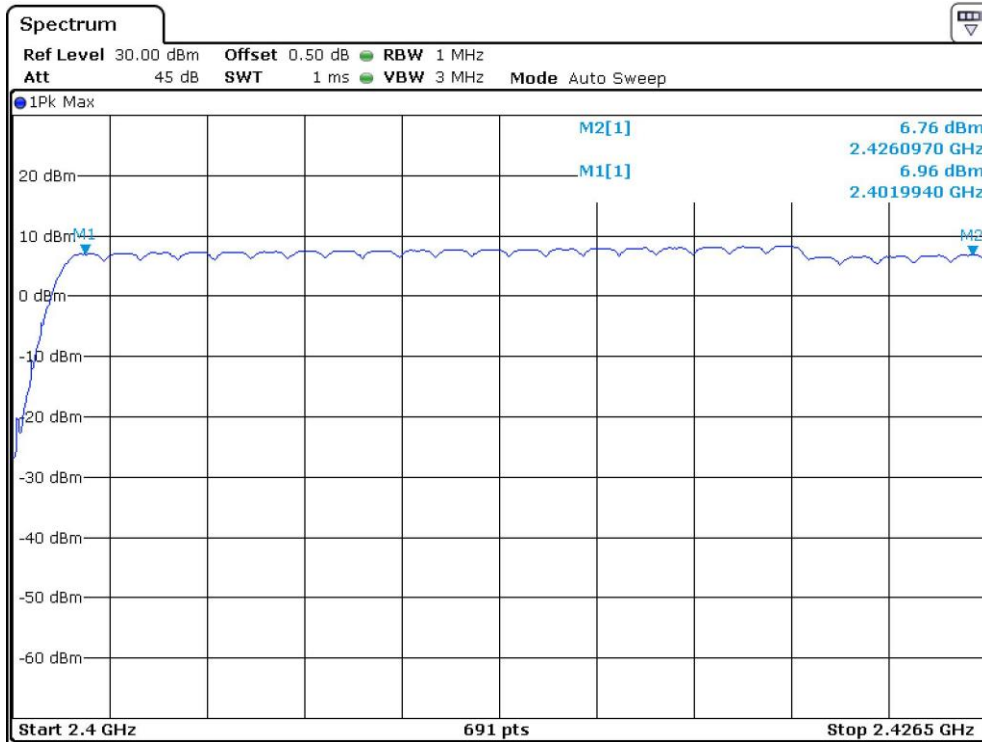

## CH25-CH52

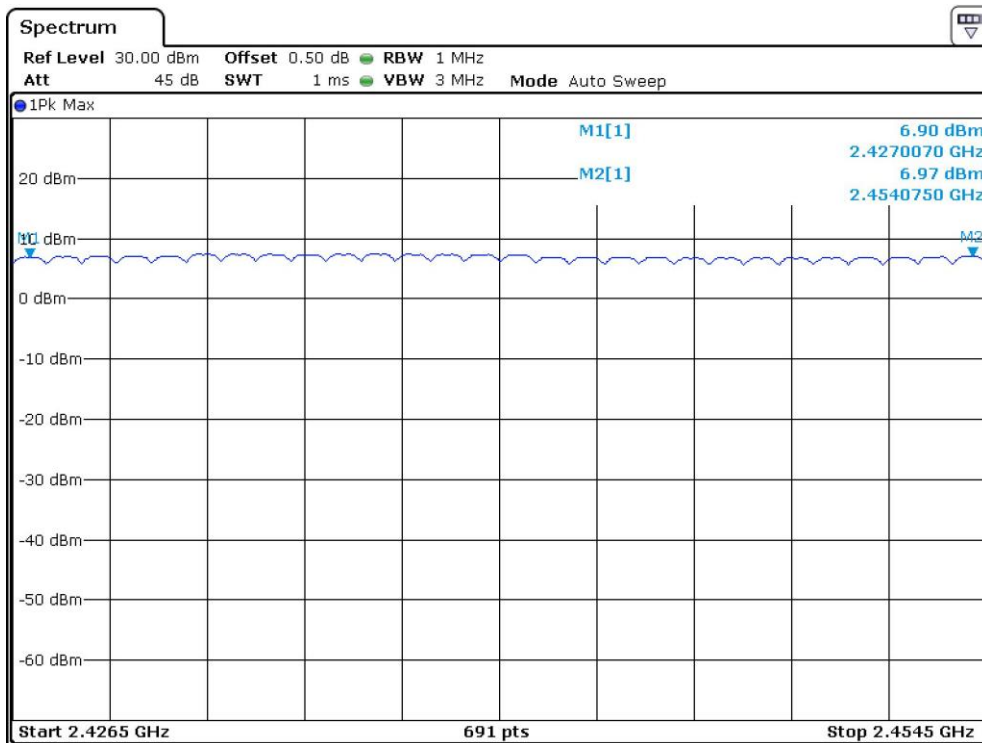

CH53-CH78

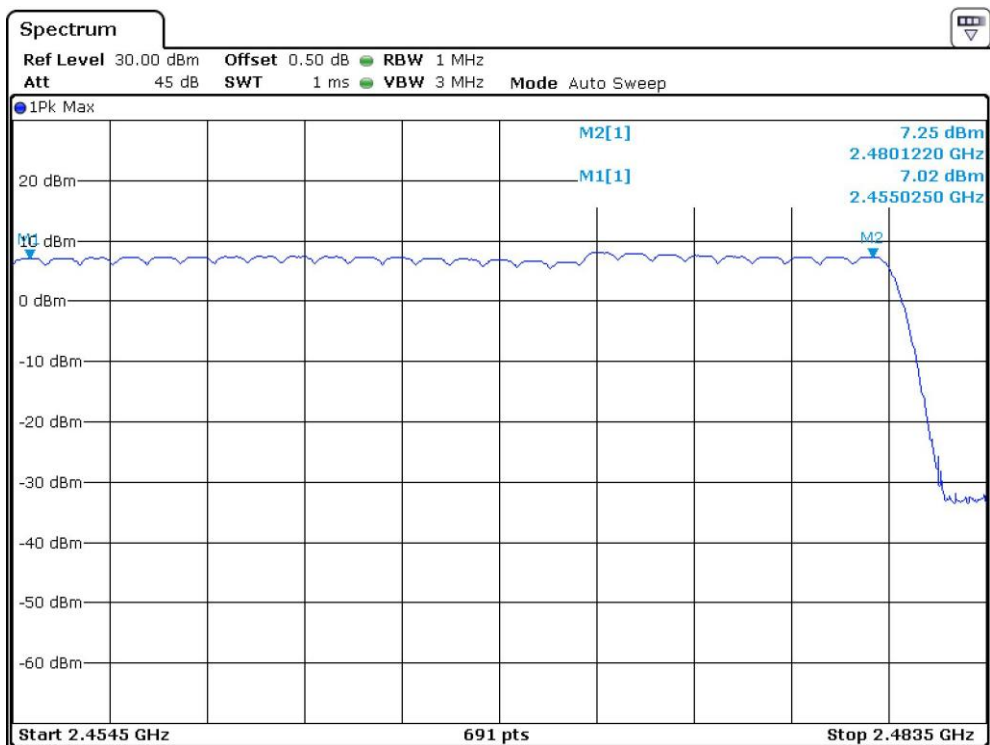

## 4.6 Channel Separation (Carrier Frequency Separation)

Minimum Hopping Channel Carrier Frequency Separation, FCC Ref: 15.247(a)(1):

Block Diagram:

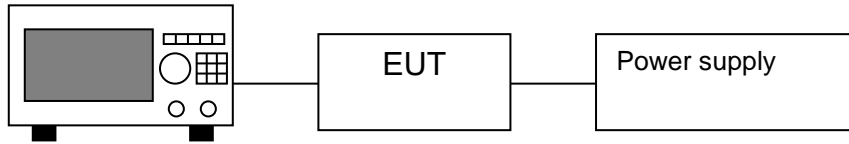

Spectrum Analyzer

Using the DELTA MARKER function of the analyzer, the frequency separation between two adjacent channels was measured and compared against the limit:

Not less than 2/3 of 20dB bandwidth of hopping channel:  $1.012 \times 2/3 = 0.675\text{MHz}$

|                            |           |
|----------------------------|-----------|
| Minimum Channel Separation | 0.999 MHz |
|----------------------------|-----------|

Modulation Type: GFSK

Low Channel

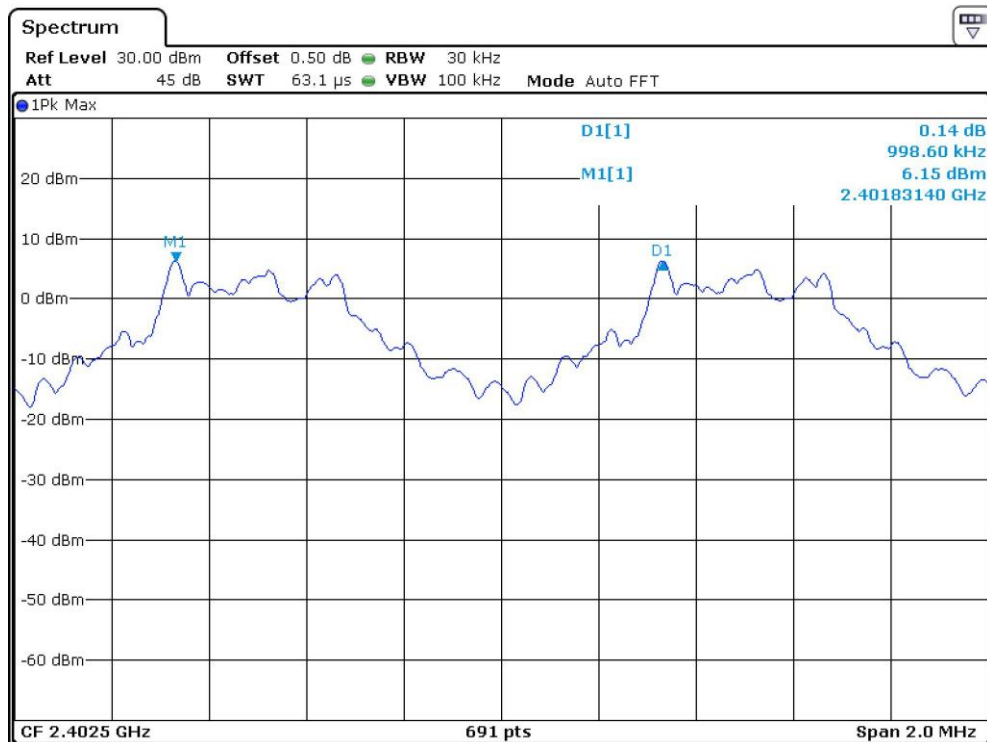

## Middle Channel

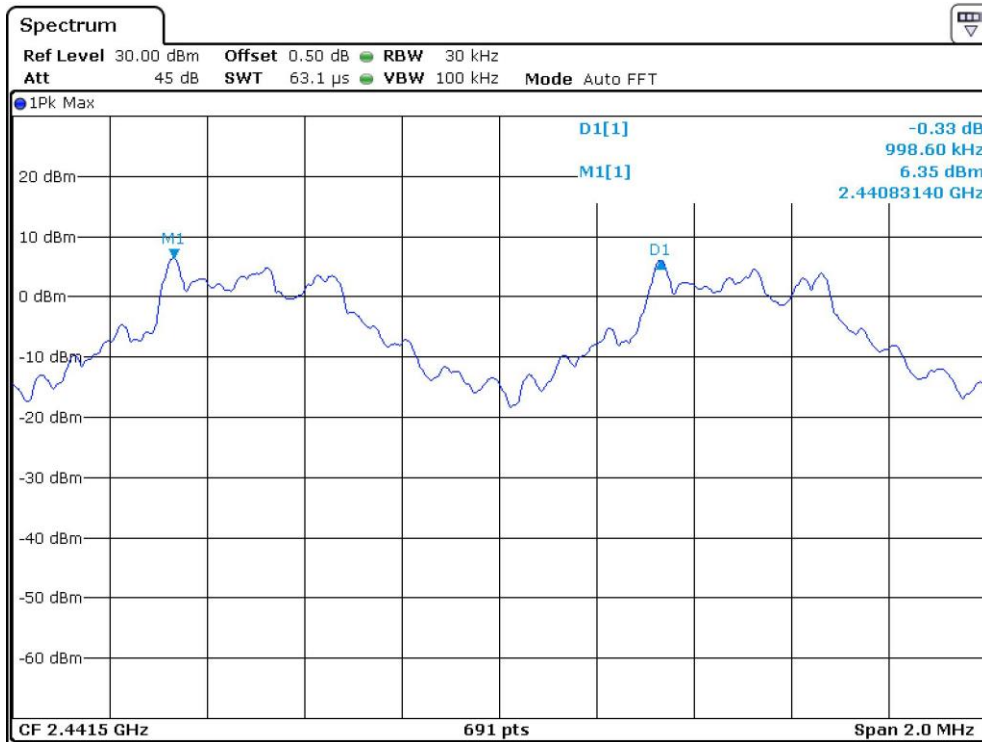

## High Channel

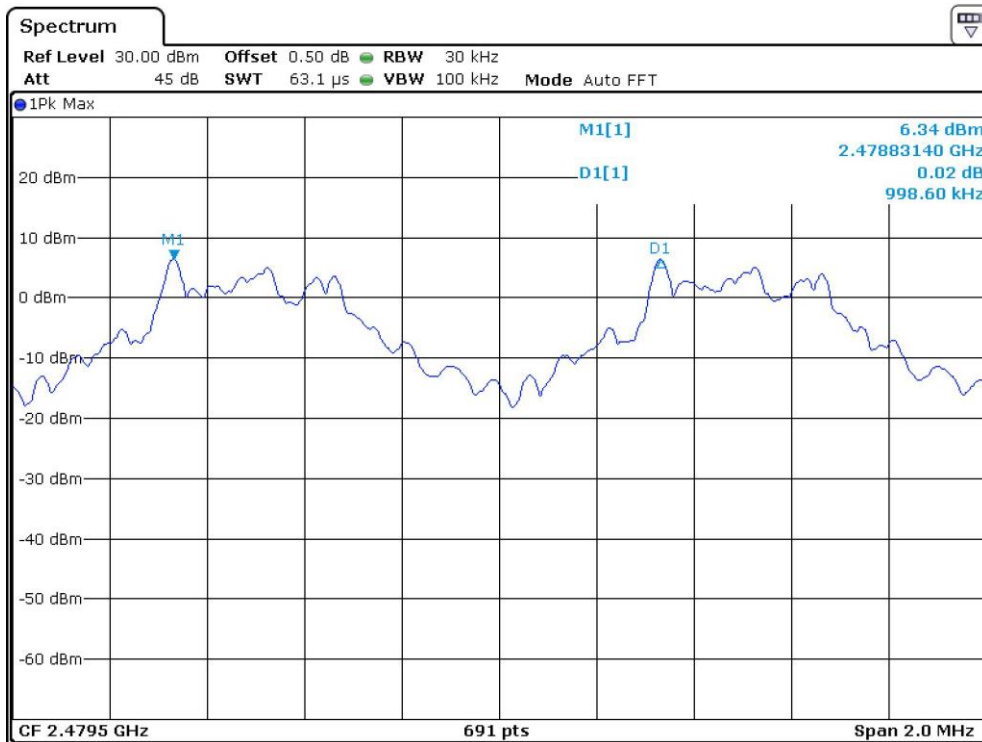

## 4.7 Dwell Time (Time of Occupancy)

Average Channel Occupancy Time, FCC Ref: 15.247(a) (1)(iii):

The spectrum analyzer center frequency was set to one of the known hopping channels with a longer sweep time to show two successive hops on a channel; the SPAN was set to ZERO SPAN, and the TRIGGER was set to VIDEO. RBW shall be  $\leq$  channel spacing and where possible RBW should be set  $\gg 1/T$ , where T is the expected dwell time per channel. The time duration of the transmissions so captured was measured with the MARKER DELTA function.

Repeat the measurement using a longer sweep time to determine the number of hops over the period specified in the requirements. The sweep time shall be equal to, or less than, the period specified in the requirements. Different modes of operation were performed and only the worst case data was reported.

Block Diagram:

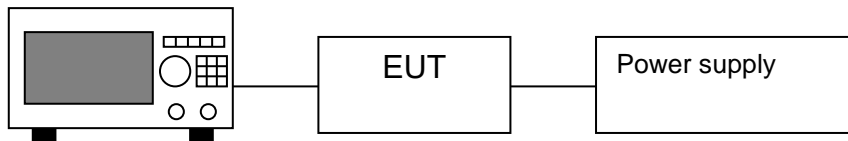

Spectrum Analyzer

Worst Test Result:

Normal hopping mode

| Modulation Type | Packet | Max Dwell Time                             | Limit (s) | Result |
|-----------------|--------|--|-----------|--------|
| GFSK            | DH1    | $0.409\text{ms} * 280 = 114.52 \text{ ms}$ | 0.4       | Pass   |
|                 | DH3    | $1.670\text{ms} * 170 = 283.90\text{ms}$   | 0.4       | Pass   |
|                 | DH5    | $2.922\text{ms} * 80 = 239.36\text{ms}$    | 0.4       | Pass   |

AFH mode:

| Modulation Type | Packet | Max Dwell Time                          | Limit (s) | Result |
|-----------------|--------|---|-----------|--------|
| GFSK            | DH1    | $0.409\text{ms} * 80 = 32.72\text{ms}$  | 0.4       | Pass   |
|                 | DH3    | $1.670\text{ms} * 45 = 75.15\text{ms}$  | 0.4       | Pass   |
|                 | DH5    | $2.922\text{ms} * 26 = 77.792\text{ms}$ | 0.4       | Pass   |

Modulation Type: GFSK

Packet: DH1

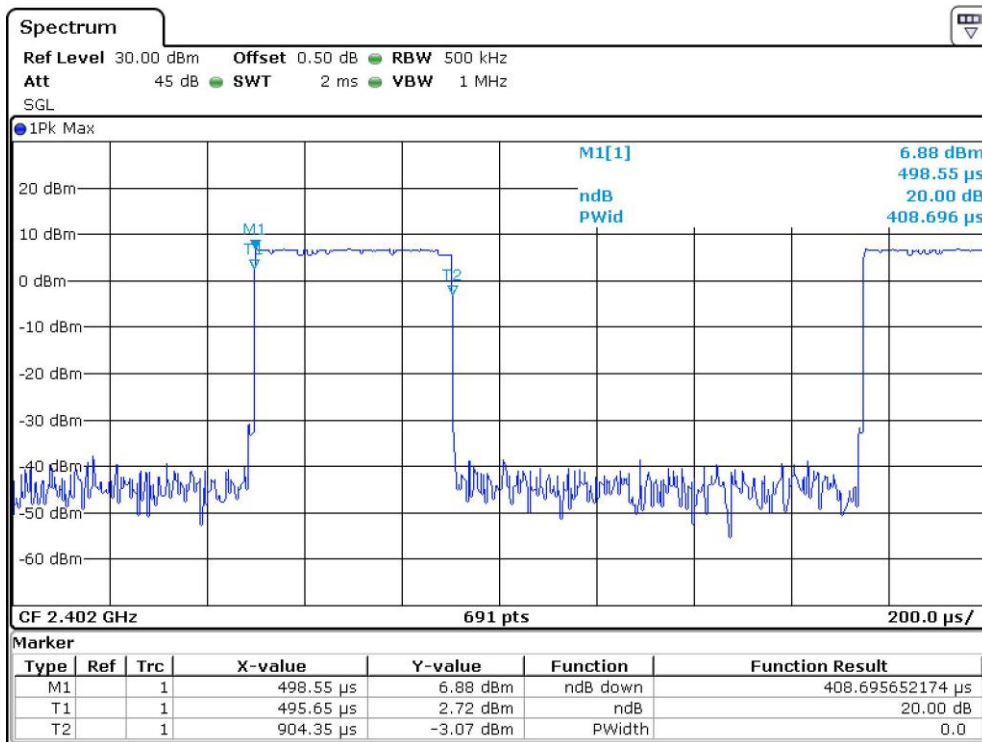

Number of hops (Normal hopping mode)

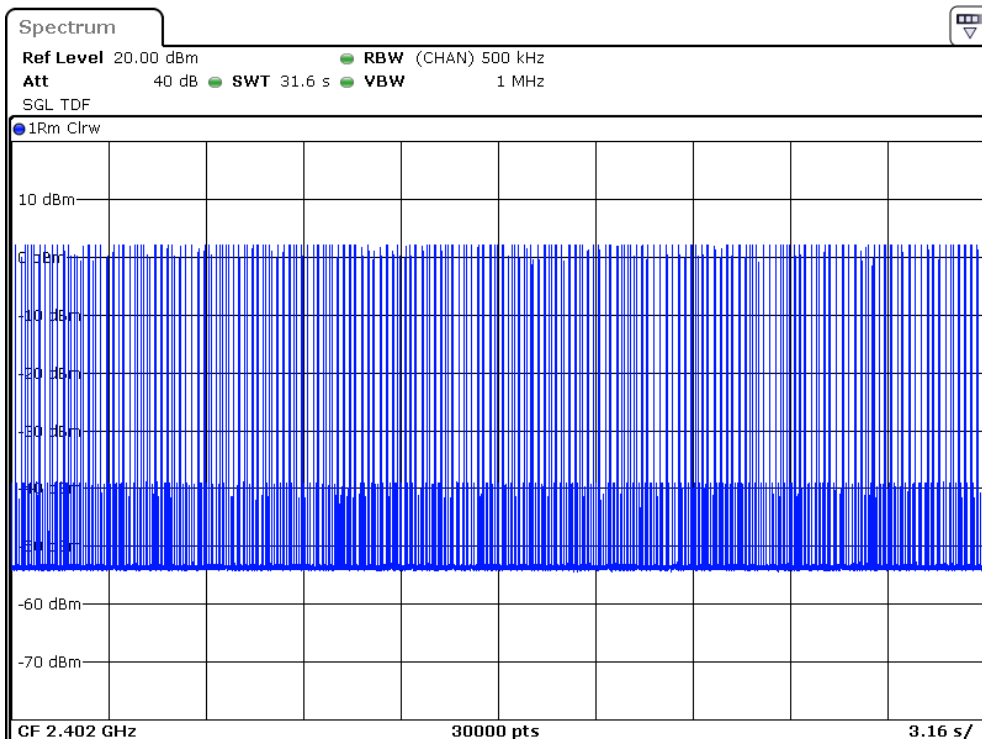





## Number of hops (Normal hopping mode)

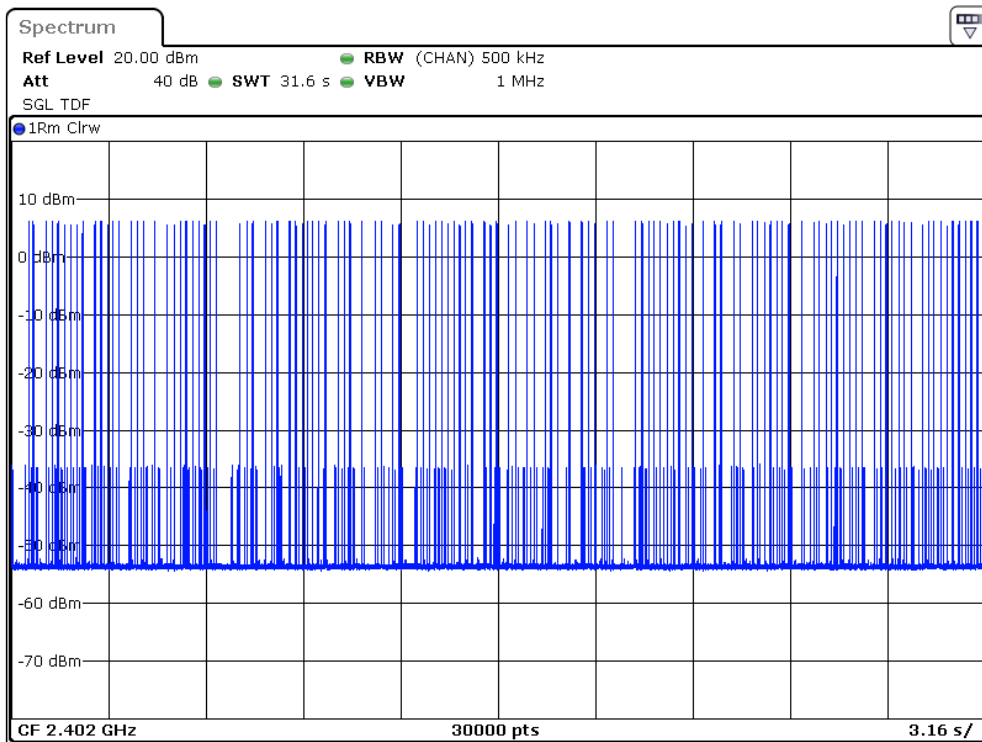

## Number of hops (AFH mode)

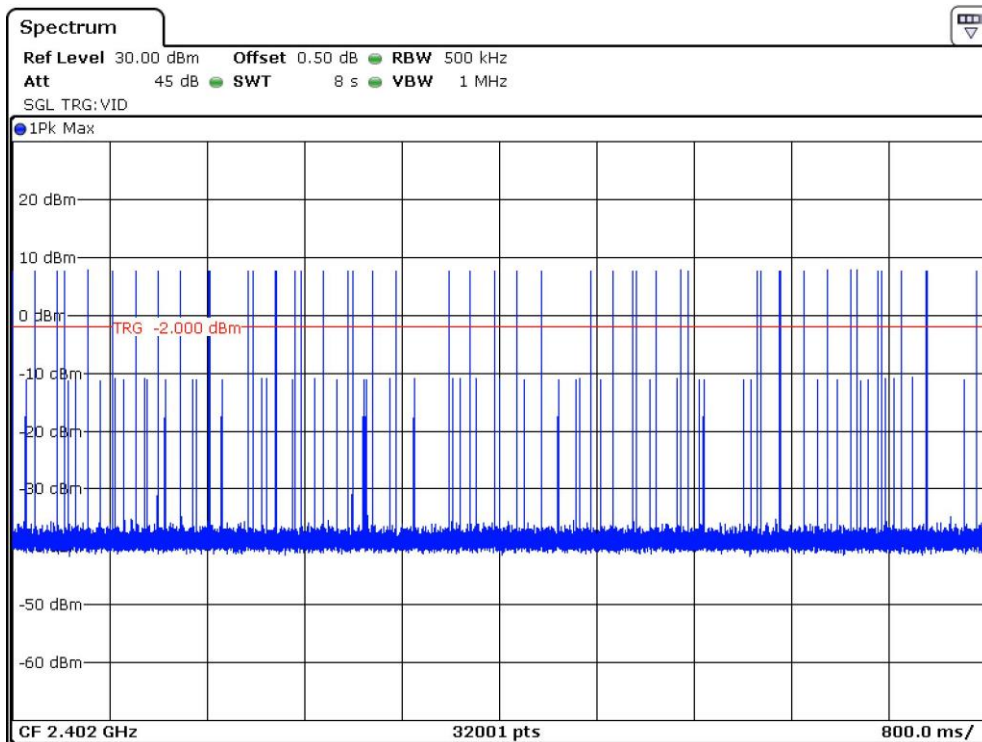

Packet: DH5

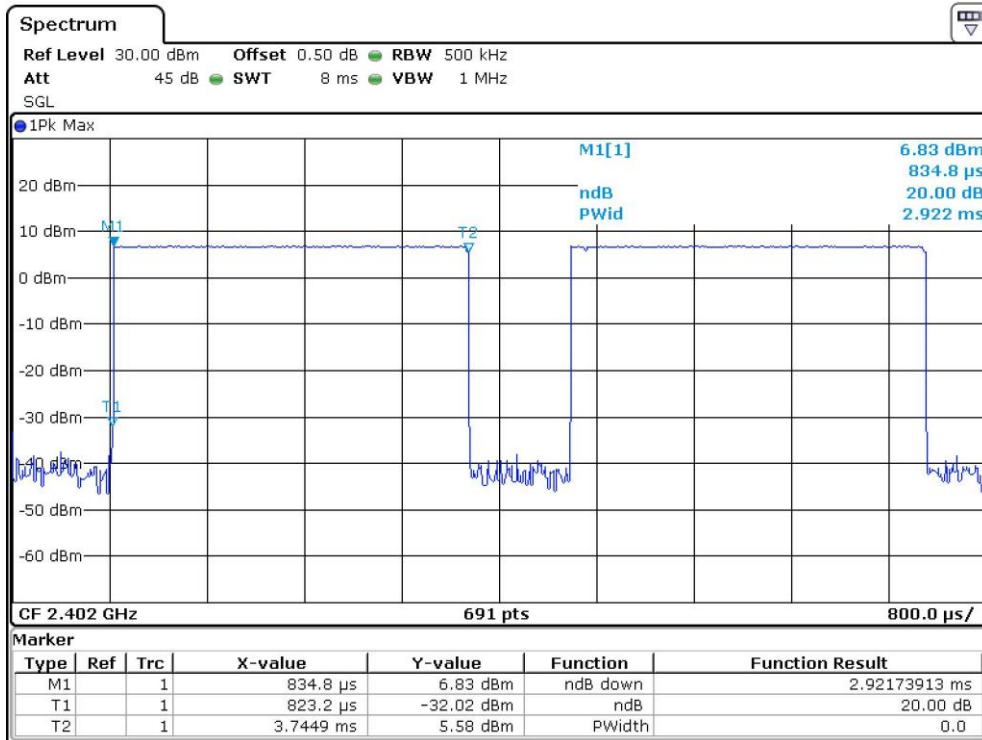

Number of hops (Normal hopping mode)

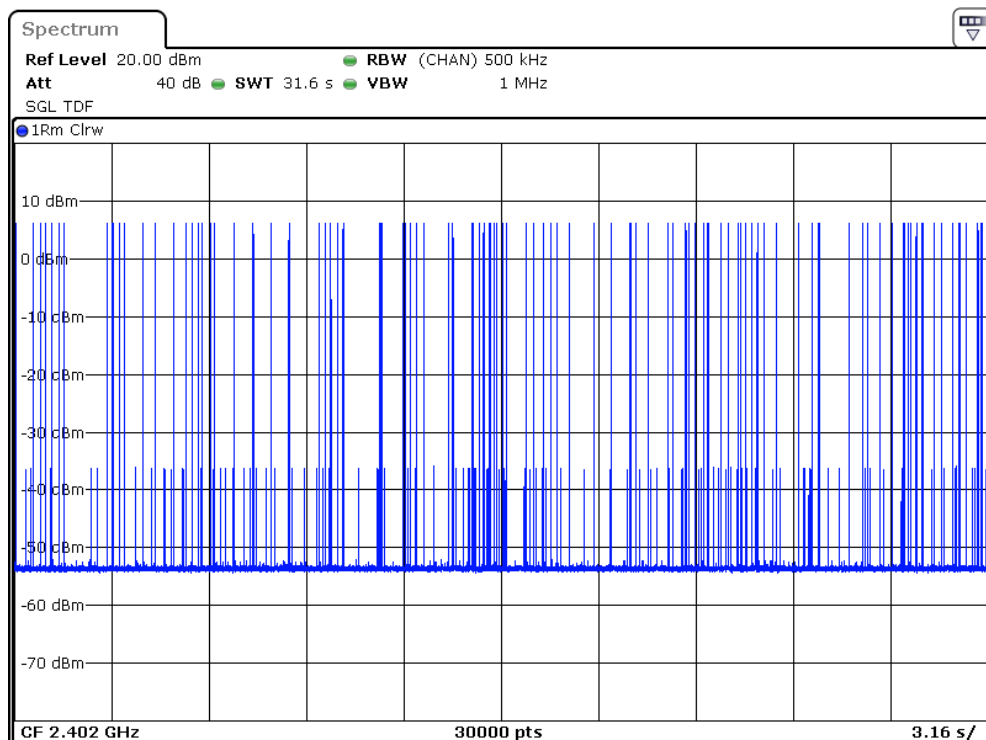

## Number of hops (AFH mode)

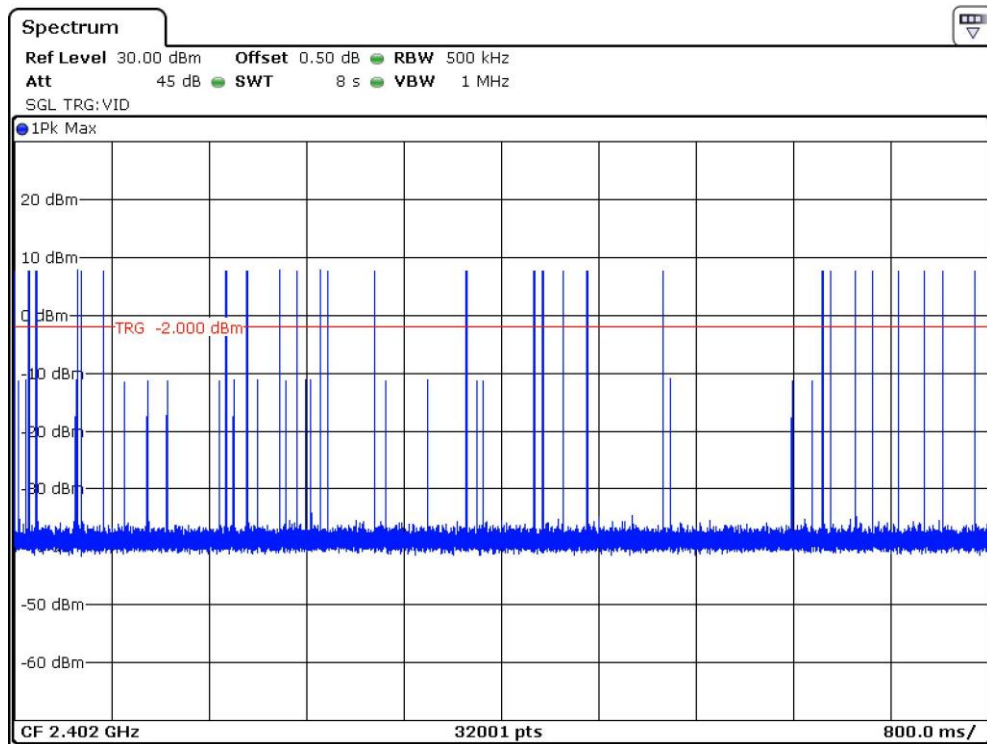

## 4.8 Band Edge

Out of Band Conducted Emissions, FCC Rule 15.247(d):

In any 100 KHz bandwidth outside the EUT passband, the RF power produced by the modulation products of the spreading sequence, the information sequence, and the carrier frequency shall be at least 20 dB below that of the maximum in-band 100 kHz emission, or else shall meet the general limits for radiated emissions at frequencies outside the passband, whichever results in lower attenuation.

Block Diagram:

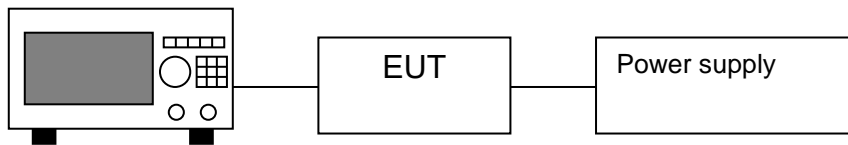

Spectrum Analyzer

Furthermore, delta measurement technique for measuring bandage emissions was shown as below:

### (i) Lower channel 2402MHz:

$$\begin{aligned}
 \text{Peak Resultant field strength} &= \text{Fundamental emissions (peak value)} - \text{delta from the} \\
 &\quad \text{bandedge plot} \\
 &= 102.5\text{dB}\mu\text{v/m} - 49.78\text{dB} \\
 &= 52.72\text{dB}\mu\text{v/m}
 \end{aligned}$$

$$\begin{aligned}
 \text{Average Resultant field strength} &= \text{Fundamental emissions (Average value)} - \text{delta from the} \\
 &\quad \text{bandedge plot} \\
 &= 80.0\text{dB}\mu\text{v/m} - 49.78\text{dB} \\
 &= 30.22\text{dB}\mu\text{v/m}
 \end{aligned}$$

### (ii) Upper channel 2480MHz:

$$\begin{aligned}
 \text{Peak Resultant field strength} &= \text{Fundamental emissions (peak value)} - \text{delta from the} \\
 &\quad \text{bandedge plot} \\
 &= 98.7\text{dB}\mu\text{v/m} - 49.70\text{dB} \\
 &= 49.00\text{dB}\mu\text{v/m}
 \end{aligned}$$

$$\begin{aligned}
 \text{Average Resultant field strength} &= \text{Fundamental emissions (Average value)} - \text{delta from the} \\
 &\quad \text{bandedge plot} \\
 &= 76.2\text{dB}\mu\text{v/m} - 49.70\text{dB} \\
 &= 26.5\text{dB}\mu\text{v/m}
 \end{aligned}$$

The resultant field strength meets the general radiated emission limit in section 15.209, which does not exceed 74dB $\mu$ v/m (Peak Limit) and 54dB $\mu$ v/m (Average Limit).

Modulation Type: GFSK  
Hopping function off

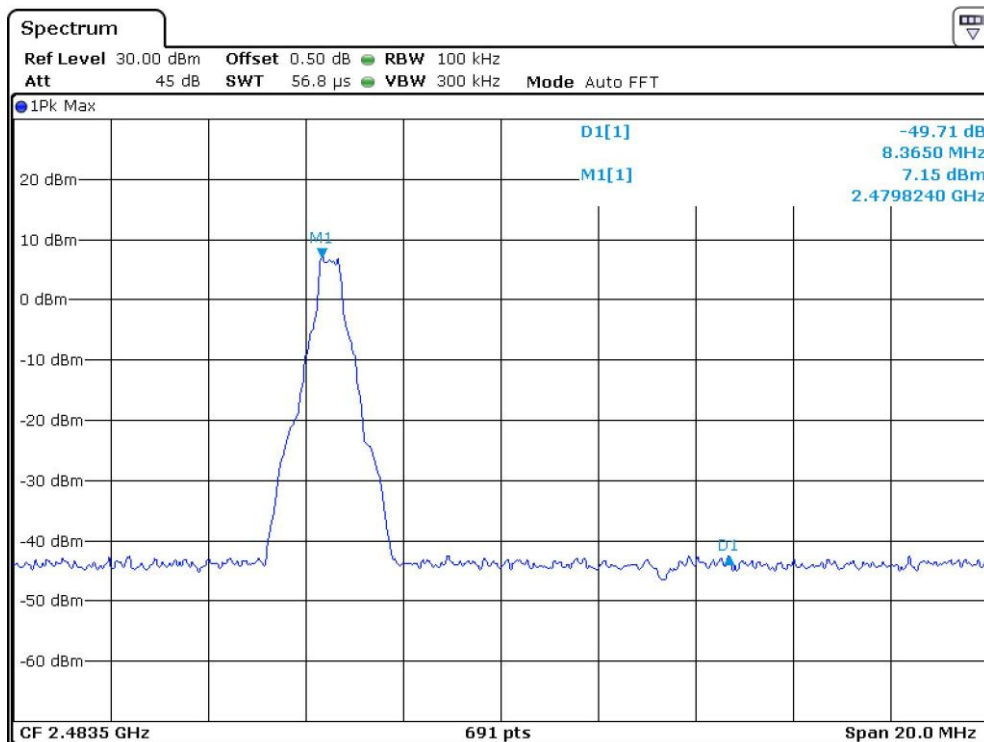
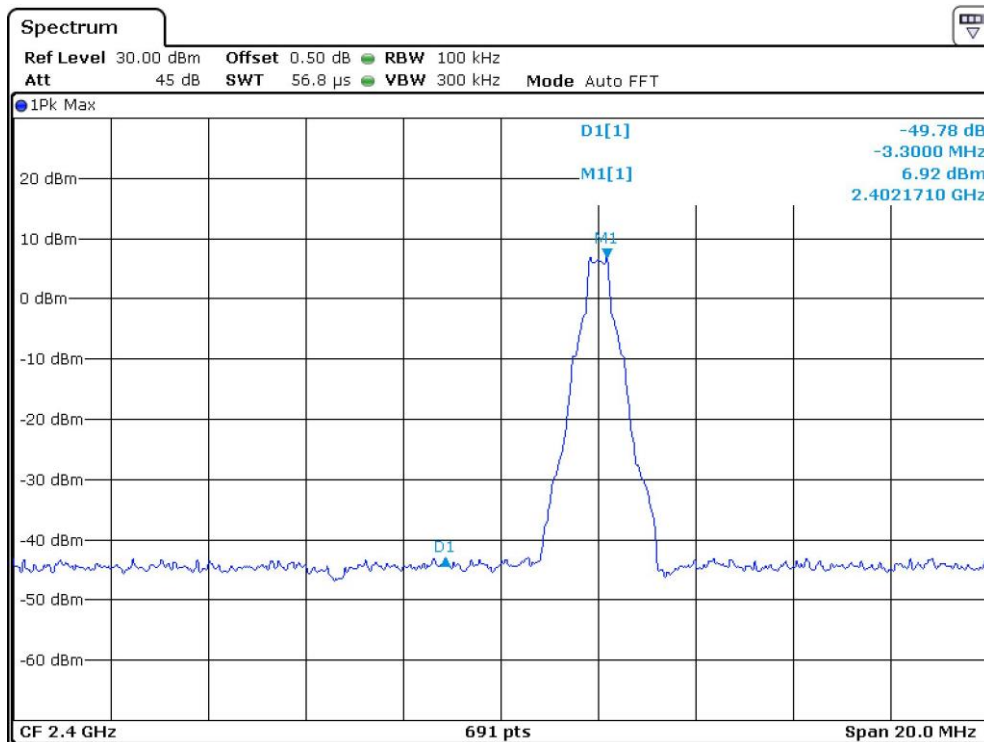

## Hopping function on

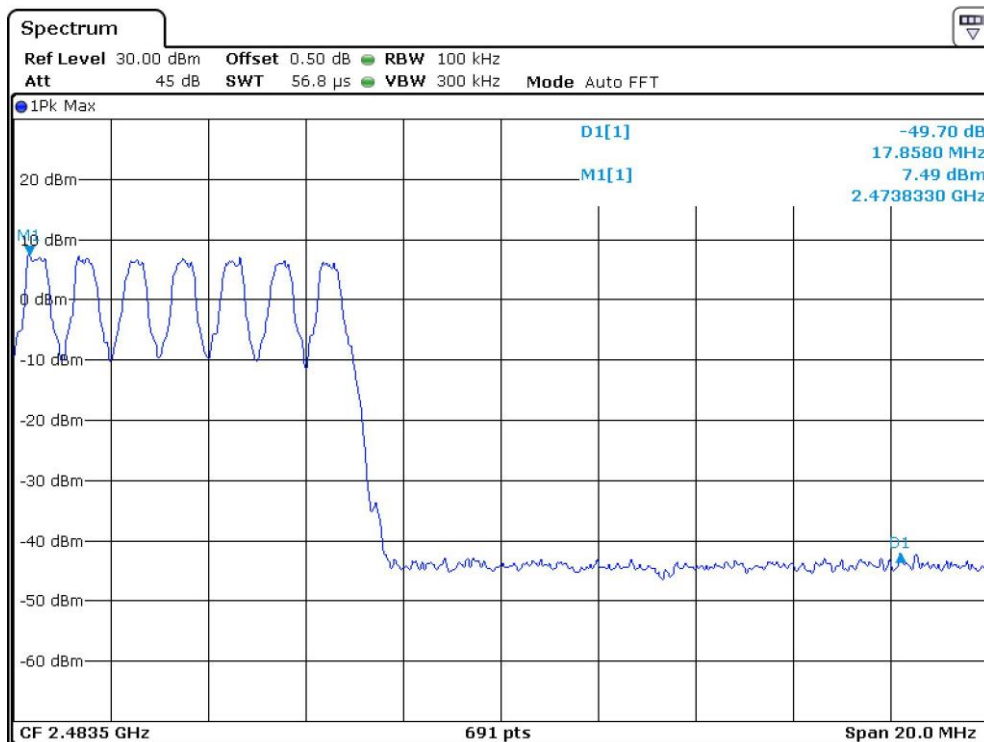
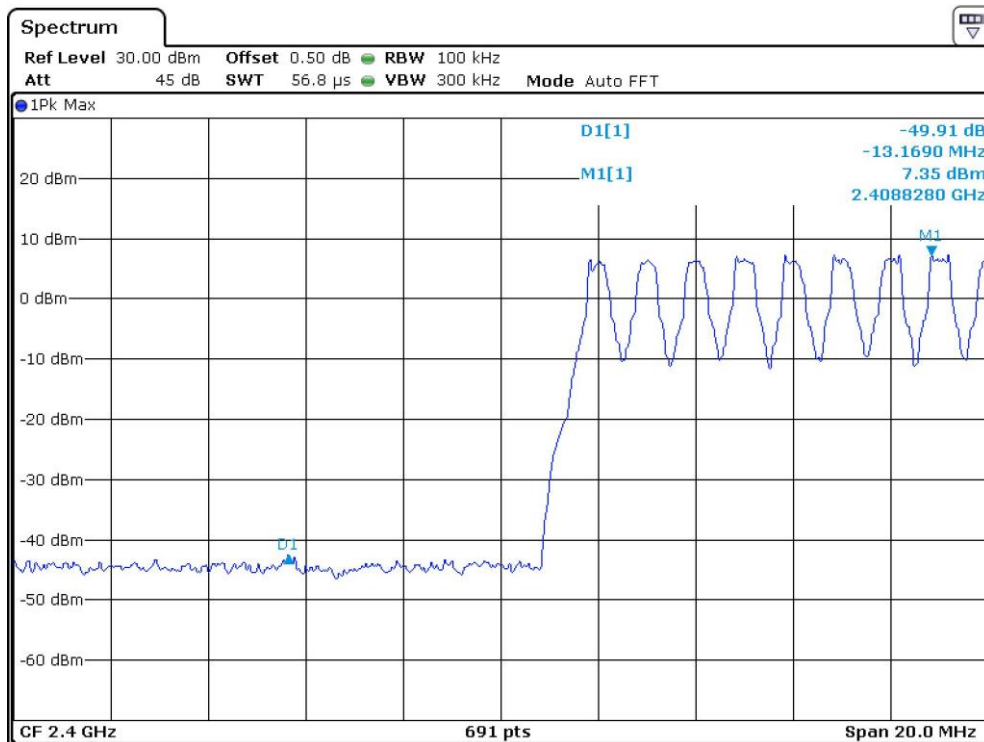

## 4.9 Transmitter Spurious Emissions (Conducted)

Out of Band Conducted Spurious Emissions, FCC Rule 15.247(d):

All spurious emission and up to the tenth harmonic was measured and they were found to be at least 20 dB below the highest level of the desired power in the passband.

Block Diagram:

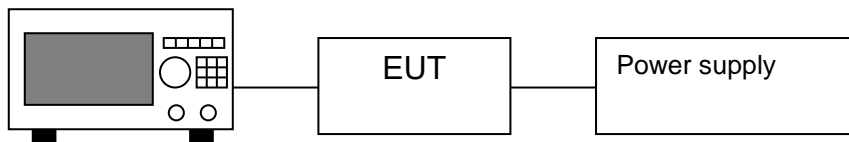

Spectrum Analyzer



Modulation Type: GFSK

CH00

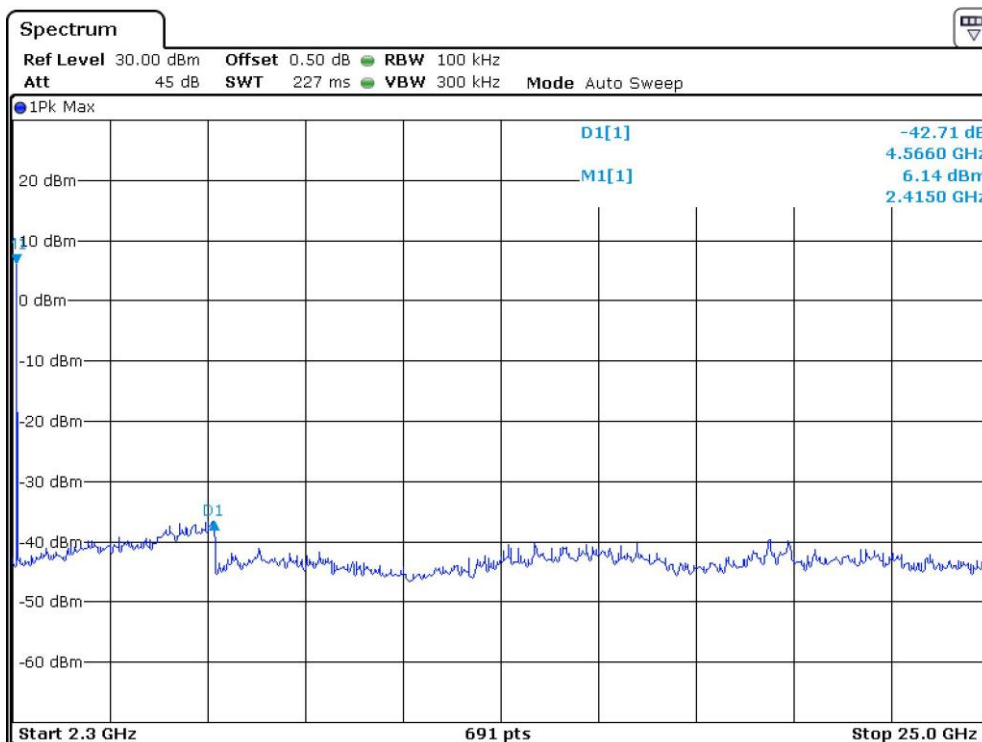
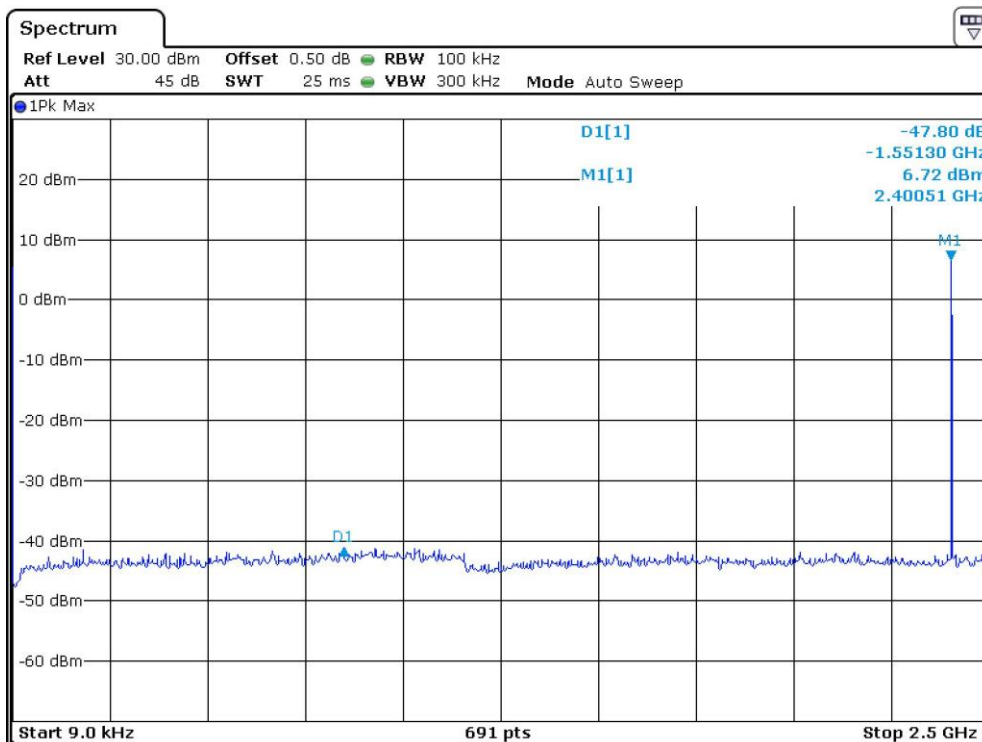

CH39

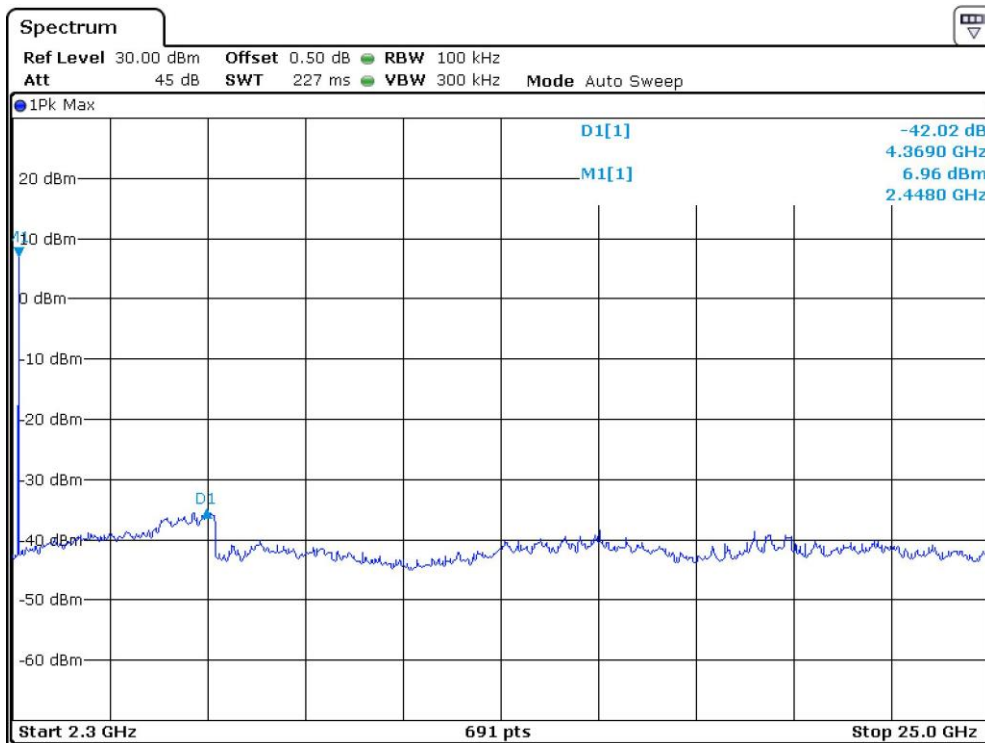
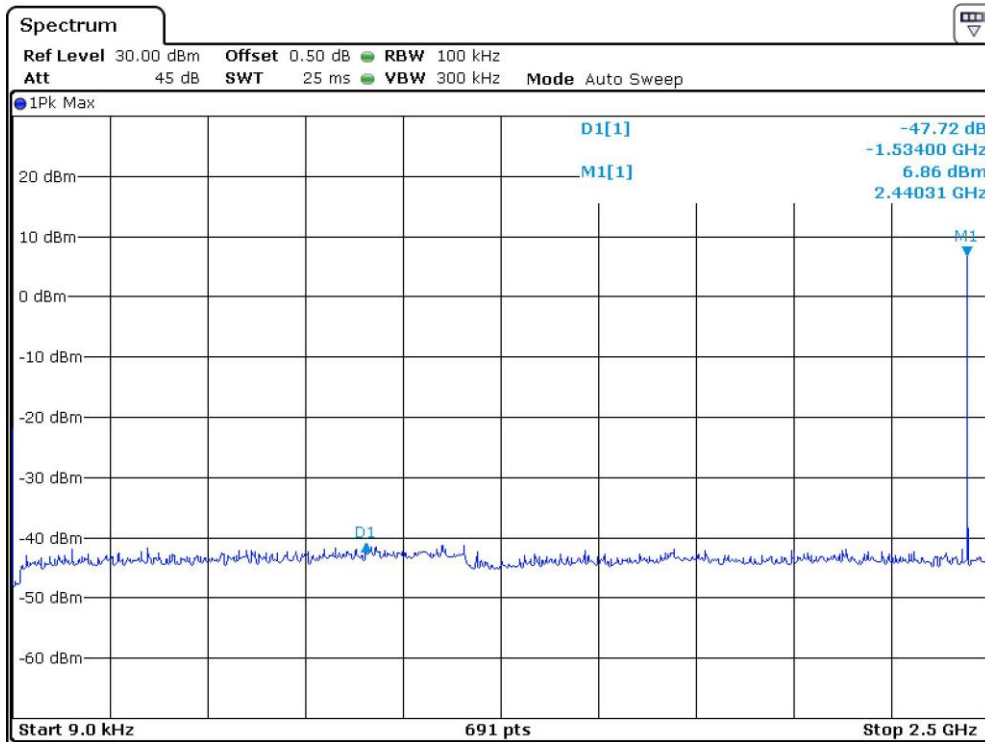

CH78

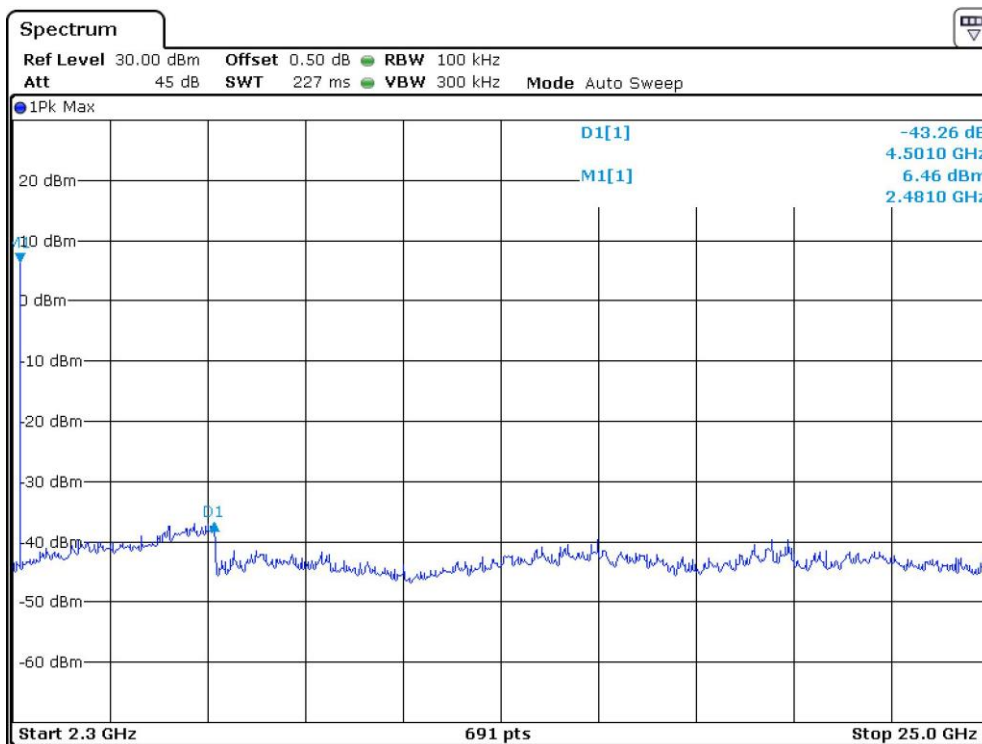
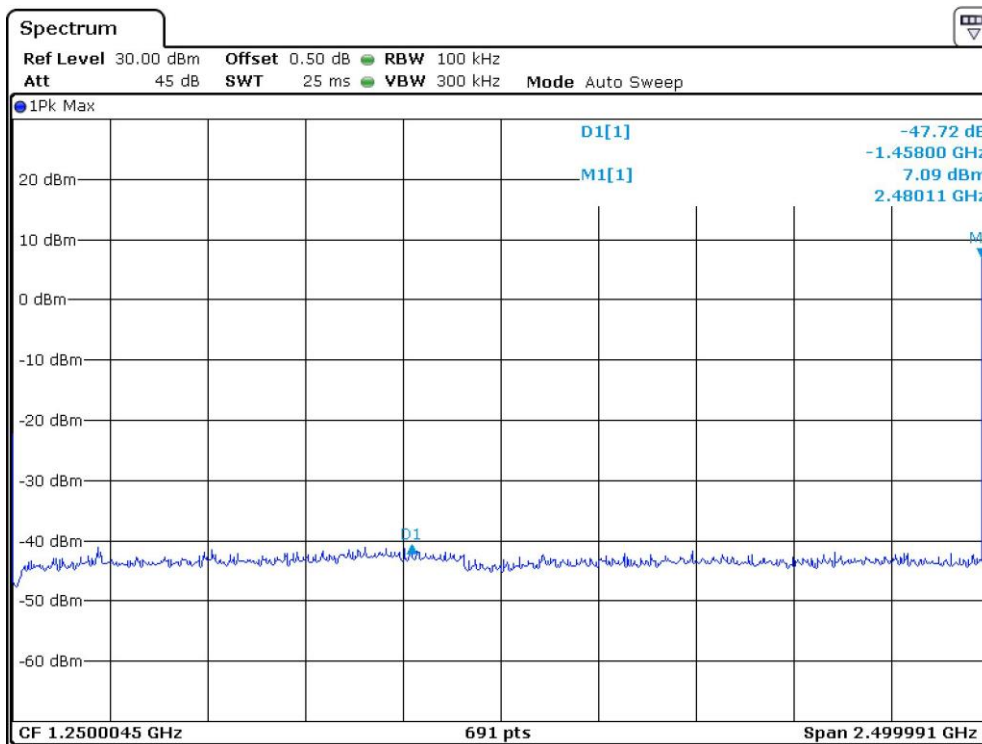

## 5.0 Equipment Photographs

For electronic filing, the photographs of the tested EUT are saved with filename: external photos.pdf & internal photos.pdf.

## 6.0 Product Labelling

For electronic filing, the FCC ID label artwork and the label location are saved with filename: label.pdf.

## 7.0 Technical Specifications

For electronic filing, the block diagram and schematics of the tested EUT are saved with filename: block.pdf and circuit.pdf respectively.

## 8.0 Instruction Manual

For electronic filing, a preliminary copy of the Instruction Manual is saved with filename: manual.pdf.

This manual will be provided to the end-user with each unit sold/leased in the United States.

## 9.0 Miscellaneous Information

This miscellaneous information includes details of the measured bandedge, the test procedure and calculation of factor such as pulse desensitization.

### 9.1 Discussion of Pulse Desensitization

Pulse desensitivity is not applicable for this device. The effective period ( $T_{eff}$ ) is approximately 625 $\mu$ s for Bluetooth. With a resolution bandwidth (3dB) of 1MHz, so the pulse desensitivity factor is 0dB.

### 9.2 Calculation of Average Factor

Based on the Bluetooth Specification Version 5.0 (EDR mode) and worst case AFH mode, transmitter ON time is independent of packet type (DH1, DH3 and DH5) and packet length, the AFH mode Duty cycle connection factor as below:

Channel hop rate = 800 hops/second (AFH Mode)

Adjusted channel hop rate for DH5 mode = 133.33 hops/second

Time per channel hop =  $1 / 133.33$  hops/second = 7.5 ms

Time to cycle through all channels =  $7.5 \times 20$  channels = 150 ms

Number of times transmitter hits on one channel =  $100 \text{ ms} / 150 \text{ ms} = 1 \text{ time(s)}$

Worst case dwell time = 7.5 ms

Duty cycle connection factor =  $20\log_{10} (7.5\text{ms} / 100\text{ms}) = -22.5 \text{ dB}$

## 9.3 Emissions Test Procedures

The following is a description of the test procedure used by Intertek Testing Services in the measurements of transmitters operating under Part 15, Subpart C rules.

The test set-up and procedures described below are designed to meet the requirements of ANSI C63.10: 2013.

The transmitting equipment under test (EUT) is placed on a styrene turntable which is four feet in diameter, up to 1GHz 0.8m and above 1GHz 1.5m in height above the ground plane. During the radiated emissions test, the turntable is rotated and any cables leaving the EUT are manipulated to find the configuration resulting in maximum emissions. The EUT is adjust through all three orthogonal axes to obtain maximum emission levels. The antenna height and polarization are varied during the testing to search for maximum signal levels.

Detector function for radiated emissions is in peak mode. Average readings, when required, are taken by measuring the duty cycle of the equipment under test and subtracting the corresponding amount in dB from the measured peak readings. A detailed description for the calculation of the average factor can be found in section 9.2.

The frequency range scanned is from the lowest radio frequency signal generated in the device which is greater than 9 kHz to the tenth harmonic of the highest fundamental frequency or 40 GHz, whichever is lower. For line conducted emissions, the range scanned is 150 kHz to 30 MHz with RBW 9KHz used.

## 9.3 Emissions Test Procedures (cont'd)

The EUT is warmed up for 15 minutes prior to the test.

AC power to the unit is varied from 85% to 115% nominal and variation in the fundamental emission field strength is recorded. If battery powered, a new, fully charged battery is used.

Conducted measurements are made as described in ANSI C63.10: 2013.

The IF bandwidth used for measurement of radiated signal strength was 10 kHz for emission below 30 MHz and 120 kHz for emission from 30 MHz to 1000 MHz. Where pulsed transmissions of short enough pulse duration warrant, a greater bandwidth is selected according to the recommendations of Hewlett Packard Application Note 150-2. Above 1000 MHz, a resolution bandwidth of 1 MHz is used (RBW 3MHz used for fundamental emission).

Transmitter measurements are normally conducted at a measurement distance of three meters. However, to assure low enough noise floor in the restricted bands and above 1 GHz, signals are acquired at a distance of one meter or less. All measurements are extrapolated to three meters using inverse scaling, but those measurements taken at a closer distance are so marked.

10 Test Equipment List

| Equipment No. | Equipment           | Manufacturer    | Model No.    | Serial No. | Cal. Date  | Due Date   |
|---------------|---------------------|-----------------|--------------|------------|------------|------------|
| SZ061-13      | BiConiLog Antenna   | ETS             | 3142E        | 00217919   | 2021-09-05 | 2024-09-05 |
| SZ185-03      | EMI Receiver        | R&S             | ESCI         | 101975     | 2024-04-23 | 2025-04-23 |
| SZ061-08      | Horn Antenna        | ETS             | 3115         | 00092346   | 2021-09-05 | 2024-09-05 |
| SZ061-06      | Active Loop Antenna | Electro-Metrics | EM-6876      | 217        | 2024-05-05 | 2027-05-05 |
| SZ056-03      | Spectrum Analyzer   | R&S             | FSP 30       | 101148     | 2024-04-22 | 2025-04-22 |
| SZ056-08      | Signal Analyzer     | R&S             | FSV 40       | 101430     | 2023-12-13 | 2024-12-13 |
| SZ181-04      | Preamplifier        | Agilent         | 8449B        | 3008A02474 | 2024-04-22 | 2025-04-22 |
| SZ188-01      | Anechoic Chamber    | ETS             | RFD-F/A-100  | 4102       | 2021-12-12 | 2024-12-12 |
| SZ062-24      | RF Cable            | RADIALL         | RG 213U      | --         | 2023-09-26 | 2024-09-26 |
| SZ062-25      | RF Cable            | RADIALL         | 0.04-26.5GHz | --         | 2023-09-26 | 2024-09-26 |
| SZ062-38      | RF Cable            | RADIALL         | 0.04-26.5GHz | --         | 2023-09-26 | 2024-09-26 |
| SZ067-04      | Notch Filter        | Micro-Tronics   | BRM50702-02  | --         | 2024-04-23 | 2025-04-23 |
| SZ185-02      | EMI Test Receiver   | R&S             | ESCI         | 100692     | 2024-07-09 | 2025-07-09 |
| SZ187-02      | Two-Line V-Network  | R&S             | ENV216       | 100073     | 2024-04-23 | 2025-04-23 |
| SZ188-03      | Shielding Room      | ETS             | RFD-100      | 4100       | 2022-12-20 | 2025-12-20 |

\*\*\*\*\* End of Report\*\*\*\*\*