



**CFR 47 FCC PART 02
CFR 47 FCC PART 22 H
CFR 47 FCC PART 24 E
CFR 47 FCC PART 27
CFR 47 FCC PART 90S**

TEST REPORT

For

LTE MODULE

MODEL NUMBER: EG25-G

FCC ID: 2A46G-EG25-G

REPORT NUMBER: 4790792905-2-RF-1

ISSUE DATE: May 8, 2023

Prepared for

Guangzhou Xaircraft Technology CO.,LTD

**Block C, No.115, Gaopu Road, Tianhe District, GuangzhouCity,
Guangdong,P.R.China**

Prepared by

UL Verification Services (Guangzhou) Co., Ltd, Song Shan Lake Branch

Building 10, Innovation Technology Park, No. 1, Li Bin Road, Song Shan Lake Hi-Tech Development Zone Dongguan, 523808, People's Republic of China

Tel: +86 769 22038881

Fax: +86 769 33244054

Website: www.ul.com



Revision History

<u>Rev.</u>	<u>Issue Date</u>	<u>Revisions</u>	<u>Revised By</u>
V0	05/08/2023	Initial Issue	

Note:

- 1.This test report is only published to and used by the applicant, and it is not for evidence purpose in China.
2. The measurement result for the sample received is <Pass> according to < CFR 47 FCC PART 22 H >< CFR 47 FCC PART 24 E>< CFR 47 FCC PART 27 > <CFR 47 FCC PART 90> when <Accuracy Method> decision rule is applied.
3. This test report includes radiated test results and conducted power test results due to the change of GSM/WCDMA/LTE antenna from the original model (FCC ID: 2A46G-EG25-G).



TABLE OF CONTENTS

1. ATTESTATION OF TEST RESULTS	4
2. TEST METHODOLOGY	5
3. FACILITIES AND ACCREDITATION	5
4. CALIBRATION AND UNCERTAINTY	6
4.1. <i>MEASURING INSTRUMENT CALIBRATION</i>	6
4.2. <i>MEASUREMENT UNCERTAINTY</i>	6
5. EQUIPMENT UNDER TEST	7
5.1. <i>DESCRIPTION OF EUT</i>	7
5.2. <i>TEST CHANNEL CONFIGURATION</i>	7
5.3. <i>MAXIMUM AVERAGE OUTPUT POWER</i>	11
5.4. <i>WORST-CASE CONFIGURATION AND MODE</i>	15
5.5. <i>DESCRIPTION OF AVAILABLE ANTENNAS</i>	16
5.6. <i>DESCRIPTION OF TEST SETUP</i>	19
6. MEASURING INSTRUMENT AND SOFTWARE USED	20
7. ANTENNA TERMINAL TEST RESULTS	21
7.1. <i>EFFECTIVE (ISOTROPIC) RADIATED POWER OF TRANSMITTER</i>	21
8. RADIATED SPURIOUS EMISSIONS	39



1. ATTESTATION OF TEST RESULTS

Applicant Information

Company Name: Guangzhou Xaircraft Technology CO.,LTD
Address: Block C, No.115, Gaopu Road, Tianhe District, GuangzhouCity, Guangdong, P.R.China

Manufacturer Information

Company Name: Guangzhou Xaircraft Technology CO.,LTD
Address: Block C, No.115, Gaopu Road, Tianhe District, GuangzhouCity, Guangdong, P.R.China

EUT Information

EUT Name: LTE MODULE
Model: EG25-G
Sample Received Date: April 5, 2023
Sample Status: Normal
Sample ID: 5938560
Date of Tested: April 5, 2023~ May 5, 2023

APPLICABLE STANDARDS	
STANDARD	TEST RESULTS
CFR 47 FCC PART 02	PASS
CFR 47 FCC PART 22 H	PASS
CFR 47 FCC PART 24 E	PASS
CFR 47 FCC PART 27	PASS
CFR 47 FCC PART 90S	PASS

Prepared By:

Kebo Zhang
Senior Project Engineer

Checked By:

Denny Huang
Senior Project Engineer

Approved By:

Stephen Guo
Operations Manager



2. TEST METHODOLOGY

The tests documented in this report were performed in accordance with ANSI C63.26-2015, 971168 D01 Power Meas License Digital Systems v03r01, 971168 D02 Misc Rev Approv License Devices v02r01, 412172 D01 v01r01 Determining ERP and EIRP, CFR 47 FCC Part 2, Part 22 H, Part 24 E, Part 27, Part 90.

3. FACILITIES AND ACCREDITATION

Accreditation Certificate	<p>A2LA (Certificate No.: 4102.01) UL Verification Services (Guangzhou) Co., Ltd. Song Shan Lake Branch. has been assessed and proved to be in compliance with A2LA.</p> <p>FCC (FCC Designation No.: CN1187) UL Verification Services (Guangzhou) Co., Ltd. Song Shan Lake Branch. Has been recognized to perform compliance testing on equipment subject to the Commission's Declaration of Conformity (DoC) and Certification rules</p> <p>ISED (Company No.: 21320) UL Verification Services (Guangzhou) Co., Ltd. Song Shan Lake Branch. has been registered and fully described in a report filed with ISED. The Company Number is 21320 and the test lab Conformity Assessment Body Identifier (CABID) is CN0046.</p> <p>VCCI (Registration No.: G-20019, R-20004, C-20012 and T-20011) UL Verification Services (Guangzhou) Co., Ltd. Song Shan Lake Branch. has been assessed and proved to be in compliance with VCCI, the Membership No. is 3793. Facility Name: Chamber D, the VCCI registration No. is G-20019 and R-20004 Shielding Room B , the VCCI registration No. is C-20012 and T-20011</p>
---------------------------	---

Note 1: All tests measurement facilities use to collect the measurement data are located at Building 10, Innovation Technology Park, Song Shan Lake Hi tech Development Zone, Dongguan, 523808, China

Note 2: The test anechoic chamber in UL Verification Services (Guangzhou) Co., Ltd. Song Shan Lake Branch had been calibrated and compared to the open field sites and the test anechoic chamber is shown to be equivalent to or worst case from the open field site.

Note 3: For below 30 MHz, lab had performed measurements at test anechoic chamber and comparing to measurements obtained on an open field site. And these measurements below 30 MHz had been correlated to measurements performed on an OFS.



4. CALIBRATION AND UNCERTAINTY

4.1. MEASURING INSTRUMENT CALIBRATION

The measuring equipment utilized to perform the tests documented in this report has been calibrated in accordance with the manufacturer's recommendations and is traceable to recognize national standards.

4.2. MEASUREMENT UNCERTAINTY

Where relevant, the following measurement uncertainty levels have been estimated for tests performed on the apparatus:

Test Item	Uncertainty
Conduction emission	3.62 dB
Radiated Emission (Included Fundamental Emission) (9 kHz ~ 30 MHz)	2.2 dB
Radiated Emission (Included Fundamental Emission) (30 MHz ~ 1 GHz)	4.00 dB
Radiated Emission (Included Fundamental Emission) (1 GHz to 40 GHz)	5.78 dB (1 GHz-18 GHz)
	5.23dB (18 GHz-26 GHz)
	5.64 dB (26 GHz-40 GHz)
Bandwidth	1.1 %

Note: This uncertainty represents an expanded uncertainty expressed at approximately the 95 % confidence level using a coverage factor of k=2.



5. EQUIPMENT UNDER TEST

5.1. DESCRIPTION OF EUT

EUT Name	LTE MODULE
Model Name	EG25-G
Supply Voltage	DC 5.8 V

5.2. TEST CHANNEL CONFIGURATION

Mode	TX	Low	Middle	High
LTE Band 2	TX (1.4 MHz)	18607	18900	19193
		1850.7 MHz	1880 MHz	1909.3 MHz
	TX (3 MHz)	18615	18900	19185
		1851.5 MHz	1880 MHz	1908.5 MHz
	TX (5 MHz)	18625	18900	19175
		1852.5 MHz	1880 MHz	1907.5 MHz
	TX (10 MHz)	18650	18900	19150
		1855 MHz	1880 MHz	1905 MHz
	TX (15 MHz)	18675	18900	19125
		1857.5 MHz	1880 MHz	1902.5 MHz
	TX (20 MHz)	18700	18900	19100
		1860 MHz	1880 MHz	1900 MHz

Mode	TX/RX	Low	Middle	High
LTE Band 4	TX (1.4 MHz)	19957	20175	20393
		1710.7 MHz	1732.5 MHz	1754.3 MHz
	TX (3 MHz)	19965	20175	20385
		1711.5 MHz	1732.5 MHz	1753.5 MHz
	TX (5 MHz)	19975	20175	20375
		1712.5 MHz	1732.5 MHz	1752.5 MHz
	TX (10 MHz)	20000	20175	20350
		1715 MHz	1732.5 MHz	1750 MHz
	TX (15 MHz)	20025	20175	20325
		1717.5 MHz	1732.5 MHz	1747.5 MHz
	TX (20 MHz)	20050	20175	20300
		1720 MHz	1732.5 MHz	1745 MHz



Mode	TX/RX	Low	Middle	High
LTE Band 5	TX (1.4 MHz)	20407	20525	20643
		824.7 MHz	836.5 MHz	848.3 MHz
	TX (3 MHz)	20415	20525	20635
		825.5 MHz	836.5 MHz	847.5 MHz
	TX (5 MHz)	20425	20525	20625
		826.5 MHz	836.5 MHz	846.5 MHz
TX (10 MHz)	20450	20525	20600	
	829.0 MHz	836.5 MHz	844.0 MHz	

Mode	TX/RX	Low	Middle	High
LTE Band 7	TX (5 MHz)	20775	21100	21425
		2502.5 MHz	2535.0 MHz	2567.5 MHz
	TX (10 MHz)	20800	21100	21400
		2505.0 MHz	2535.0 MHz	2565.0 MHz
	TX (15 MHz)	20825	21100	21400
		2507.5 MHz	2535.0 MHz	2562.5 MHz
TX (20 MHz)	20850	21100	21350	
	2510.0 MHz	2535.0 MHz	2560.0 MHz	

Mode	TX/RX	Low	Middle	High
LTE Band 25	TX (1.4 MHz)	26047	26365	26683
		1850.7 MHz	1882.5 MHz	1914.3 MHz
	TX (3 MHz)	26055	26365	26675
		1851.5 MHz	1882.5 MHz	1913.5 MHz
	TX (5 MHz)	26065	26365	26665
		1852.5 MHz	1882.5 MHz	1912.5 MHz
	TX (10 MHz)	26090	26365	26640
		1855.0 MHz	1882.5 MHz	1910.0 MHz
	TX (15 MHz)	26115	26365	26615
		1857.5 MHz	1882.5 MHz	1907.5 MHz
	TX (20 MHz)	26140	26365	26590
		1860.0 MHz	1882.5 MHz	1905.0 MHz



Mode	TX/RX	Low	Middle	High
LTE Band 26 814-824 MHz	TX (1.4 MHz)	26697	26740	26783
		814.7 MHz	819.0 MHz	823.3 MHz
	TX (3 MHz)	26705	26740	26775
		815.5 MHz	819.0 MHz	822.5 MHz
	TX (5 MHz)	26715	26740	26765
		816.5 MHz	819.0 MHz	821.5 MHz
	TX (10 MHz)	/	26740	/
		/	819.0 MHz	/

Mode	TX/RX	Low	Middle	High
LTE Band 26 824-849 MHz	TX (1.4 MHz)	26797	26915	27033
		824.7 MHz	836.5 MHz	848.3 MHz
	TX (3 MHz)	26805	26915	27025
		825.5 MHz	836.5 MHz	847.5 MHz
	TX (5 MHz)	26815	26915	27015
		826.5 MHz	836.5 MHz	846.5 MHz
	TX (10 MHz)	26840	26915	26990
		829.0 MHz	836.5 MHz	844.0 MHz
	TX (15 MHz)	26865	26915	26965
		831.5 MHz	836.5 MHz	841.5 MHz



Mode	TX/RX	Low	Middle	High
LTE Band 38	TX (5 MHz)	37775	38000	38225
		2572.5 MHz	2595.0 MHz	2617.5 MHz
	TX (10 MHz)	37800	38000	38200
		2575.0MHz	2595.0 MHz	2615.0 MHz
	TX (15 MHz)	37825	38000	38175
		2577.5 MHz	2595.0 MHz	2612.5 MHz
TX (20 MHz)	37850	38000	38150	
	2580.0 MHz	2595.0 MHz	2610.0 MHz	

Mode	TX/RX	Low	Middle	High
LTE Band 41	TX (5 MHz)	39675	40620	41564
		2498.5 MHz	2593.0 MHz	2687.5 MHz
	TX (10 MHz)	39700	40620	41539
		2501.0 MHz	2593.0 MHz	2685.0 MHz
	TX (15 MHz)	39725	40620	41514
		2503.5 MHz	2593.0 MHz	2682.5 MHz
TX (20 MHz)	39750	40620	41489	
	2506.0 MHz	2593.0 MHz	2680.0 MHz	



5.3. MAXIMUM AVERAGE OUTPUT POWER

Note1: The actual measurement is conducted power, the regulations require the measurement of EIRP/ERP, and Section 5.3 is the result after conversion.

Note2: All the power data was confirmed to be within the expected manufacturing tolerances of the original granted power prior to performing any tests in test reports.

LTE Band 2

Part 24								
EIRP Limit(W)		2						
Antenna Gain (dBi)		2.7						
Bandwidth (MHz)	Modulation	Low Frequency (MHz)	Upper Frequency (MHz)	Conducted Average (dBm)	EIRP Average (dBm)	EIRP Average(W)	99%OBW (MHz)	Emission Designator
1.4	QPSK	1850.7	1909.3	21.70	24.40	0.28	1.084	1M08G7D
	16QAM			20.81	23.51	0.22	1.083	1M08W7D
3	QPSK	1851.5	1908.5	21.49	24.19	0.26	2.684	2M68G7D
	16QAM			20.63	23.33	0.22	2.685	2M69W7D
5	QPSK	1852.5	1907.5	21.45	24.15	0.26	4.486	4M49G7D
	16QAM			20.63	23.33	0.22	4.484	4M48W7D
10	QPSK	1855.0	1905.0	21.59	24.29	0.27	8.946	8M95G7D
	16QAM			21.07	23.77	0.24	8.947	8M95W7D
15	QPSK	1857.5	1902.5	21.56	24.26	0.27	13.421	13M4G7D
	16QAM			20.79	23.49	0.22	13.42	13M4W7D
20	QPSK	1860.0	1900.0	21.81	24.51	0.28	17.95	18M0G7D
	16QAM			21.43	24.13	0.26	17.946	18M0W7D

LTE Band 4

Part 27								
EIRP Limit(W)		1.00						
Antenna Gain (dBi)		2.8						
Bandwidth (MHz)	Modulation	Low Frequency (MHz)	Upper Frequency (MHz)	Conducted Average (dBm)	EIRP Average (dBm)	EIRP Average(W)	99%OBW (MHz)	Emission Designator
1.4	QPSK	1710.7	1754.3	22.53	25.33	0.34	1.093	1M09G7D
	16QAM			21.92	24.72	0.30	1.09	1M09W7D
3	QPSK	1711.5	1753.5	22.56	25.36	0.34	2.695	2M70G7D
	16QAM			21.51	24.31	0.27	2.692	2M69W7D
5	QPSK	1712.5	1752.5	22.60	25.40	0.35	4.498	4M50G7D
	16QAM			21.44	24.24	0.27	4.501	4M50W7D
10	QPSK	1715.0	1750.0	22.62	25.42	0.35	8.95	8M95G7D
	16QAM			21.93	24.73	0.30	8.944	8M94W7D
15	QPSK	1717.5	1747.5	22.61	25.41	0.35	13.421	13M4G7D
	16QAM			22.14	24.94	0.31	13.408	13M4W7D
20	QPSK	1720.0	1745.0	22.82	25.62	0.36	17.92	17M9G7D
	16QAM			22.23	25.03	0.32	17.904	17M9W7D



LTE Band 5

Part 22								
ERP Limit(W)		7.00						
Antenna Gain (dBi)		1.2						
Bandwidth (MHz)	Modulation	Low Frequency (MHz)	Upper Frequency (MHz)	Conducted Average (dBm)	ERP Average (dBm)	ERP Average(W)	99%OBW (MHz)	Emission Designator
1.4	QPSK	824.7	848.3	23.09	22.14	0.16	1.088	1M09G7D
	16QAM			22.44	21.49	0.14	1.088	1M09W7D
3	QPSK	825.5	847.5	23.02	22.07	0.16	2.692	2M70G7D
	16QAM			21.81	20.86	0.12	2.69	2M70W7D
5	QPSK	826.5	846.5	23.10	22.15	0.16	4.497	4M50G7D
	16QAM			21.90	20.95	0.12	4.506	4M50W7D
10	QPSK	829.0	844.0	23.16	22.21	0.17	8.956	8M96G7D
	16QAM			22.14	21.19	0.13	8.949	8M95W7D

LTE Band 7

Part 27								
EIRP Limit(W)		2						
Antenna Gain (dBi)		2.7						
Bandwidth (MHz)	Modulation	Low Frequency (MHz)	Upper Frequency (MHz)	Conducted Average (dBm)	EIRP Average (dBm)	EIRP Average(W)	99%OBW (MHz)	Emission Designator
5	QPSK	2502.5	2567.5	21.38	24.08	0.26	4.496	4M50G7D
	16QAM			19.97	22.67	0.18	4.504	4M50W7D
10	QPSK	2505.0	2565.0	21.02	23.72	0.24	8.963	8M96G7D
	16QAM			21.32	24.02	0.25	8.951	8M95W7D
15	QPSK	2507.5	2562.5	21.47	24.17	0.26	13.449	13M5G7D
	16QAM			20.54	23.24	0.21	13.433	13M4W7D
20	QPSK	2510.0	2560.0	21.69	24.39	0.27	17.975	18M0G7D
	16QAM			21.01	23.71	0.23	17.983	18M0W7D



LTE Band 25

Part 24								
EIRP Limit(W)		2						
Antenna Gain (dBi)		2.7						
Bandwidth (MHz)	Modulation	Low Frequency (MHz)	Upper Frequency (MHz)	Conducted Average (dBm)	EIRP Average (dBm)	EIRP Average(W)	99%OBW (MHz)	Emission Designator
1.4	QPSK	1850.7	1914.3	22.34	25.04	0.32	1.088	1M09G7D
	16QAM			21.85	24.55	0.29	1.091	1M09W7D
3	QPSK	1851.5	1913.5	22.28	24.98	0.31	2.695	2M70G7D
	16QAM			21.16	23.86	0.24	2.691	2M69W7D
5	QPSK	1852.5	1912.5	22.40	25.10	0.32	4.494	4M49G7D
	16QAM			21.27	23.97	0.25	4.506	4M51W7D
10	QPSK	1855.0	1910.0	22.32	25.02	0.32	8.965	8M97G7D
	16QAM			21.35	24.05	0.25	8.956	8M96W7D
15	QPSK	1857.5	1907.5	22.39	25.09	0.32	13.464	13M5G7D
	16QAM			21.43	24.13	0.26	13.425	13M4W7D
20	QPSK	1860.0	1905.0	22.58	25.28	0.34	17.971	18M0G7D
	16QAM			21.87	24.57	0.29	17.973	18M0W7D

LTE Band 26-1

Part 90S								
Conducted Limit(W)		100						
Antenna Gain (dBi)		1.2						
Bandwidth (MHz)	Modulation	Low Frequency (MHz)	Upper Frequency (MHz)	Conducted Average (dBm)	EIRP Average (dBm)	EIRP Average(W)	99%OBW (MHz)	Emission Designator
1.4	QPSK	814.7	823.3	23.11	/	/	1.09	1M09G7D
	16QAM			22.20	/	/	1.09	1M09W7D
3	QPSK	815.5	822.5	23.04	/	/	2.694	2M70G7D
	16QAM			22.28	/	/	2.69	2M70W7D
5	QPSK	816.5	821.5	23.05	/	/	4.495	4M50G7D
	16QAM			22.18	/	/	4.506	4M51W7D
10	QPSK	819	819	22.94	/	/	8.978	8M98G7D
	16QAM			22.41	/	/	8.972	8M96W7D



LTE Band 26-2

Part 22								
ERP Limit(W)		7						
Antenna Gain (dBi)		1.2						
Bandwidth (MHz)	Modulation	Low Frequency (MHz)	Upper Frequency (MHz)	Conducted Average (dBm)	ERP Average (dBm)	ERP Average(W)	99%OBW (MHz)	Emission Designator
1.4	QPSK	824.7	848.3	23.05	22.1	0.16	1.089	1M09G7D
	16QAM			22.21	21.26	0.13	1.09	1M09W7D
3	QPSK	825.5	847.5	22.91	21.96	0.16	2.693	2M70G7D
	16QAM			22.13	21.18	0.13	2.691	2M70W7D
5	QPSK	826.5	846.5	22.69	21.74	0.15	4.494	4M49G7D
	16QAM			21.70	20.75	0.12	4.506	4M51W7D
10	QPSK	829	844	22.75	21.8	0.15	8.956	8M96G7D
	16QAM			22.11	21.16	0.13	8.949	8M95W7D
15	QPSK	831.5	841.5	22.71	21.76	0.15	13.434	13M4G7D
	16QAM			22.22	21.27	0.13	13.431	13M4W7D

LTE Band 38

Part 27								
EIRP Limit(W)		2						
Antenna Gain (dBi)		2.7						
Bandwidth (MHz)	Modulation	Low Frequency (MHz)	Upper Frequency (MHz)	Conducted Average (dBm)	EIRP Average (dBm)	EIRP Average(W)	99%OBW (MHz)	Emission Designator
5	QPSK	2572.5	2617.5	21.77	24.47	0.28	4.496	4M50G7D
	16QAM			21.14	23.84	0.24	4.488	4M49W7D
10	QPSK	2575.0	2615.0	21.85	24.55	0.29	8.957	8M96G7D
	16QAM			21.34	24.04	0.25	8.946	8M95W7D
15	QPSK	2577.5	2612.5	21.82	24.52	0.28	13.431	13M4G7D
	16QAM			20.94	23.64	0.23	13.418	13M4W7D
20	QPSK	2580.0	2610.0	21.86	24.56	0.29	17.94	17M9G7D
	16QAM			21.27	23.97	0.25	17.93	17M9W7D

LTE Band 41

Part 27								
EIRP Limit(W)		2						
Antenna Gain (dBi)		2.7						
Bandwidth (MHz)	Modulation	Low Frequency (MHz)	Upper Frequency (MHz)	Conducted Average (dBm)	EIRP Average (dBm)	EIRP Average(W)	99%OBW (MHz)	Emission Designator
5	QPSK	2498.5	2687.5	22.19	24.89	0.31	4.497	4M50G7D
	16QAM			21.54	24.24	0.27	4.503	4M50W7D
10	QPSK	2501.0	2685.0	22.17	24.87	0.31	8.96	8M96G7D
	16QAM			21.77	24.47	0.28	8.947	8M95W7D
15	QPSK	2503.5	2682.5	22.27	24.97	0.31	13.424	13M4G7D
	16QAM			21.14	23.84	0.24	13.412	13M4W7D
20	QPSK	2506.0	2680.0	22.68	25.38	0.35	17.939	17M9G7D
	16QAM			21.57	24.27	0.27	17.921	17M9W7D

5.4. WORST-CASE CONFIGURATION AND MODE

During all testing, EUT is in link mode with base station emulator at maximum power level. The worst-case scenario for all measurements is based on the average conducted output power measurement investigation results. Output power measurements were measured on QPSK, 16QAM. All testing was performed using QPSK and 16QAM modulations to represent the worst case.

The radiated spurious emissions measurements were carried out in semi-anechoic chamber with 3-meter test range, and EUT was investigated in three orthogonal orientations X,Y and Z. It was determined that X orientation was the worst-case.

Radiated spurious emissions were investigated below 30 MHz, 30 MHz - 1 GHz and above 1 GHz. There were no emissions found on below 1GHz and above 18 GHz, the emissions between 1 GHz – 18 GHz were tested the highest transmitting power channel and the worse configuration.

Test Items	Worst case test configuration			
Description	Modulation	Channel	Bandwidth (MHz)	RB Configuration
Radiated Spurious Emissions	QPSK	L, M, H	Maximum BW	RB size=1, RB Location=Low

The EUT have three kinds of antenna and have the same antenna type, only the worst-case antenna data record in this report.



5.5. DESCRIPTION OF AVAILABLE ANTENNAS

Antenna	Model	Antenna Type	Remark
1	030374F4GA	FPC	MAIN Antenna
2	030374F4GA	FPC	DIV Antenna
Band		Antenna Type	MAX Antenna Gain (dBi)
LTE Band 2		FPC	0.5
LTE Band 4		FPC	2.5
LTE Band 5		FPC	1.2
LTE Band 7		FPC	2.0
LTE Band 25		FPC	2.7
LTE Band 26		FPC	0.5
LTE Band 38		FPC	2.0
LTE Band 41		FPC	2.0

Antenna	Model	Antenna Type	Remark
1	030383F4GA	FPC	MAIN Antenna
2	030383F4GA	FPC	DIV Antenna
Band		Antenna Type	MAX Antenna Gain (dBi)
LTE Band 2		FPC	2.7
LTE Band 4		FPC	2.7
LTE Band 5		FPC	0.3
LTE Band 7		FPC	2.7
LTE Band 25		FPC	2.7
LTE Band 26		FPC	0.3
LTE Band 38		FPC	2.7
LTE Band 41		FPC	2.7



Antenna	Model	Antenna Type	Remark
1	030359F4GA	FPC	MAIN Antenna
2	030359F4GA	FPC	DIV Antenna
Band		Antenna Type	MAX Antenna Gain (dBi)
LTE Band 2		FPC	2.5
LTE Band 4		FPC	2.8
LTE Band 5		FPC	1.2
LTE Band 7		FPC	2.0
LTE Band 25		FPC	2.5
LTE Band 26		FPC	1.2
LTE Band 38		FPC	2.0
LTE Band 41		FPC	2.0



Band	Transmit and Receive Mode	Description
LTE Band 2	<input checked="" type="checkbox"/> 1TX, 1RX	Antenna 1 can be used as transmitting/receiving antenna.
LTE Band 4	<input checked="" type="checkbox"/> 1TX, 1RX	Antenna 1 can be used as transmitting/receiving antenna.
LTE Band 5	<input checked="" type="checkbox"/> 1TX, 1RX	Antenna 1 can be used as transmitting/receiving antenna.
LTE Band 7	<input checked="" type="checkbox"/> 1TX, 1RX	Antenna 1 can be used as transmitting/receiving antenna.
LTE Band 25	<input checked="" type="checkbox"/> 1TX, 1RX	Antenna 1 can be used as transmitting/receiving antenna.
LTE Band 26	<input checked="" type="checkbox"/> 1TX, 1RX	Antenna 1 can be used as transmitting/receiving antenna.
LTE Band 38	<input checked="" type="checkbox"/> 1TX, 1RX	Antenna 1 can be used as transmitting/receiving antenna.
LTE Band 41	<input checked="" type="checkbox"/> 1TX, 1RX	Antenna 1 can be used as transmitting/receiving antenna.

Note: The value of the antenna gain was declared by customer.

5.6. DESCRIPTION OF TEST SETUP

Conducted

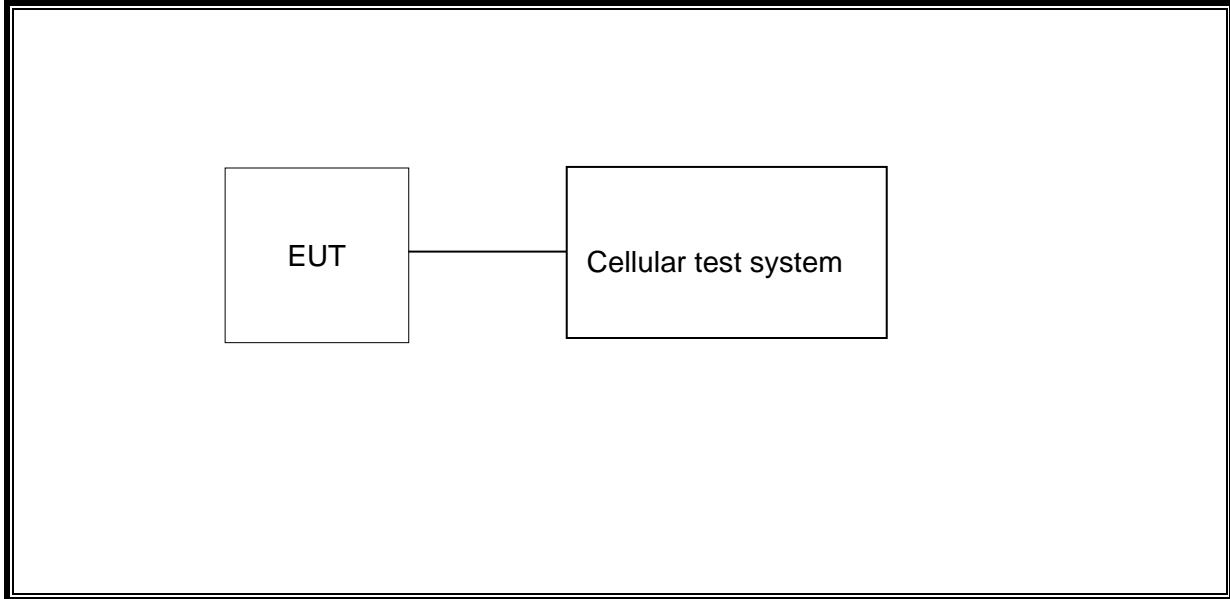

Radiated

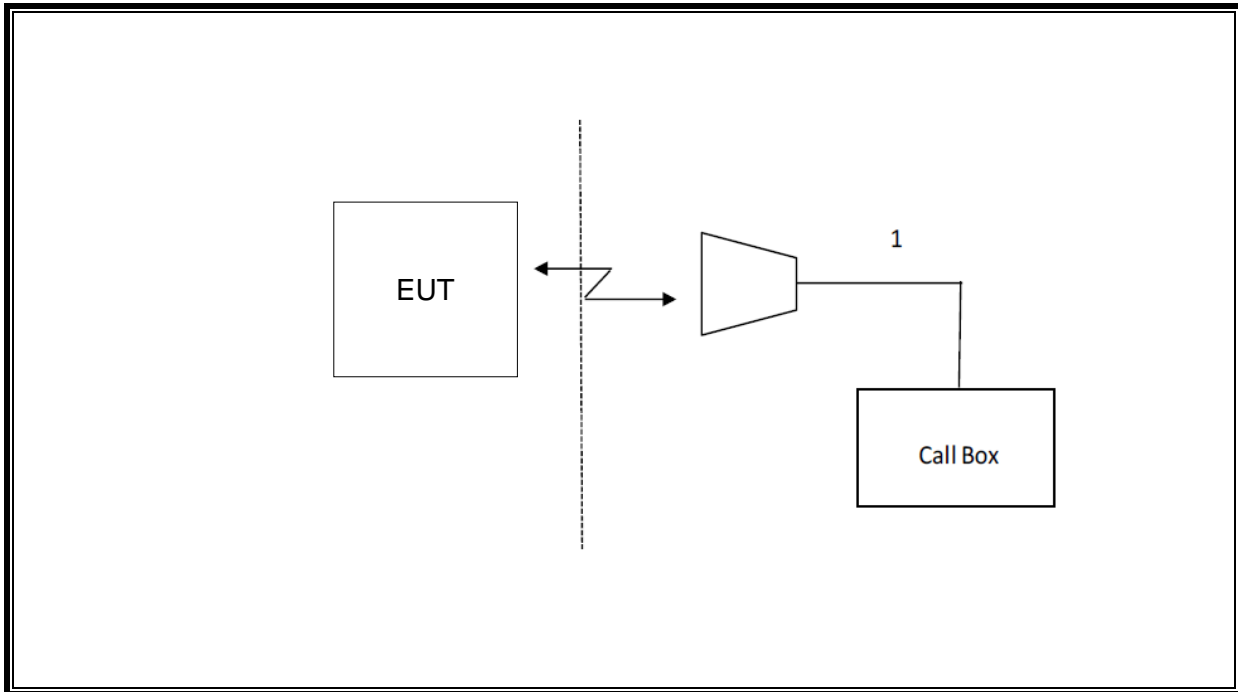

**6. MEASURING INSTRUMENT AND SOFTWARE USED**

Antenna Terminal Test						
Instrument						
Used	Equipment	Manufacturer	Model No.	Serial No.	Last Cal.	Next Cal.
<input checked="" type="checkbox"/>	Spectrum Analyzer	R&S	FSV40	S422060001	Oct.17, 2022	Oct.16, 2023
<input checked="" type="checkbox"/>	Wideband Radio Communication Tester	R&S	CMW500	155523	Oct.17, 2022	Oct.16, 2023
<input checked="" type="checkbox"/>	DC Power Supply	Array	3662A	A1512015	Oct.17, 2022	Oct.16, 2023
Software						
Used	Description	Manufacturer	Name	Version		
<input checked="" type="checkbox"/>	Tonsend Cellular Test System	Tonsend	JS1120 RF Auto Test System	3.1.46		
Radiated Test						
Instrument						
Used	Equipment	Manufacturer	Model No.	Serial No.	Last Cal.	Next Cal.
<input checked="" type="checkbox"/>	MXE EMI Receiver	KESIGHT	N9038A	MY56400036	Oct.17, 2022	Oct.16, 2023
<input checked="" type="checkbox"/>	Hybrid Log Periodic Antenna	TDK	HLP-3003C	130959	Aug.02, 2021	Aug.01, 2024
<input checked="" type="checkbox"/>	Preamplifier	HP	8447D	2944A09099	Oct.17, 2022	Oct.16, 2023
<input checked="" type="checkbox"/>	EMI Measurement Receiver	R&S	ESR26	101377	Oct.17, 2022	Oct.16, 2023
<input checked="" type="checkbox"/>	Horn Antenna	TDK	HRN-0118	130940	July 20, 2021	July 19, 2024
<input checked="" type="checkbox"/>	Horn Antenna	Schwarzbeck	BBHA9170	697	July 20, 2021	July 19, 2024
<input checked="" type="checkbox"/>	Preamplifier	TDK	PA-02-0118	TRS-305-00067	Oct.17, 2022	Oct.16, 2023
<input checked="" type="checkbox"/>	Preamplifier	TDK	PA-02-2	TRS-307-00003	Oct.17, 2022	Oct.16, 2023
<input checked="" type="checkbox"/>	Loop antenna	Schwarzbeck	1519B	00008	Dec.14, 2021	Dec.13, 2024
<input checked="" type="checkbox"/>	High Pass Filter	Wi	WHKX10-2700-3000-18000-40SS	23	\	\
Software						
Used	Description	Manufacturer	Name	Version		
<input checked="" type="checkbox"/>	Test Software for Radiated disturbance	Farad	EZ-EMC	Ver. UL-3A1		

7. ANTENNA TERMINAL TEST RESULTS

Note: All the conducted test data transfer to the ERP/EIRP values, It comply with the limit requirement, Only the Conducted test data were showed in the test report.

7.1. EFFECTIVE (ISOTROPIC) RADIATED POWER OF TRANSMITTER

RULE PART(S)

FCC: §2.1046, §22.913, §24.232, §27.50, §90

LIMITS

22.913(a) The ERP of mobile transmitters and auxiliary test transmitters must not exceed 7 Watts.

24.232(c) Mobile/portable stations are limited to 2 watts e.i.r.p. peak power and the equipment must employ means to limit the power to the minimum necessary for successful communications.

27.50(c) Portable stations (hand-held devices) in the 600 MHz uplink band and the 698-746 MHz band, and fixed and mobile stations in the 600 MHz uplink band are limited to 3 watts ERP.

27.50(d) Fixed, mobile, and portable (hand-held) stations operating in the 1710-1755 MHz band and mobile and portable stations operating in the 1695-1710 MHz and 1755-1780 MHz bands are limited to 1 watts EIRP.

27.50(h) Mobile stations are limited to 2.0 watts EIRP. All user stations are limited to 2.0 watts transmitter output power.

In addition, when the transmitter power is measured in terms of average value, the peak-to-average ratio of the power shall not exceed 13 dB.

TEST PROCEDURE

Refer to ANSI C63.26:2015 and KDB 971168 D01 Section 5.6

$ERP/ EIRP = P_{Meas} + GT - LC$

where:

ERP or EIRP = effective or equivalent isotropically radiated power, respectively (expressed in the same units as P_{Meas} , typically dBW or dBm);

P_{Meas} = measured transmitter output power or PSD, in dBm or dBW;

GT = gain of the transmitting antenna, in dBd (ERP) or dBi (EIRP);

LC = signal attenuation in the connecting cable between the transmitter and antenna, in dB

The transmitter has a maximum radiated ERP / EIRP output powers as follows:

TEST SETUP

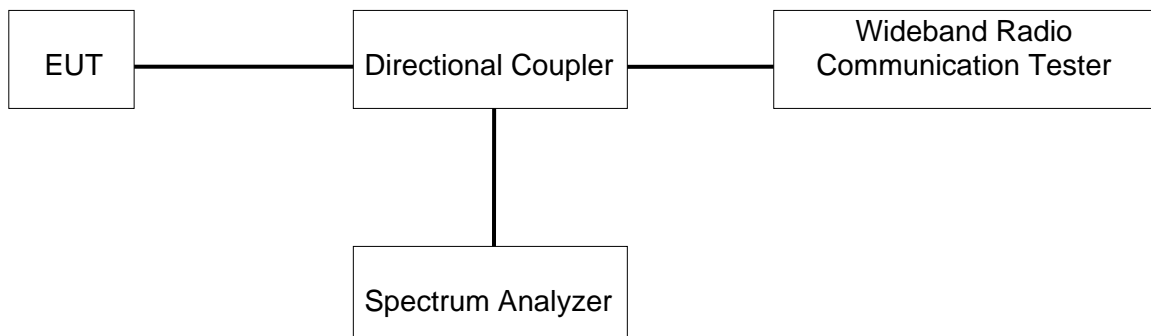

**TEST ENVIRONMENT**

Temperature	23.4°C	Relative Humidity	54.4%
Atmosphere Pressure	101kPa	Test Voltage	DC 5.8 V

RESULT

LTE FDD B2				Conducted Power(dBm)		
Bandwidth	Modulation	RB size	RB offset	Channel	Channel	Channel
				18607	18900	19193
1.4MHz	QPSK	1	0	21.41	21.7	21.16
		1	2	21.39	21.62	21.17
		1	5	21.53	21.56	21.12
		3	0	21.4	21.51	21.24
		3	1	21.49	21.54	21.2
		3	3	21.49	21.57	21.09
		6	0	20.58	20.5	20.17
	16QAM	1	0	20.25	20.5	20.3
		1	2	20.53	20.81	20.44
		1	5	20.69	20.77	20.41
		3	0	20.39	20.6	20.17
		3	1	20.38	20.58	19.95
		3	3	20.56	20.44	20.2
		6	0	19.55	19.72	19.18
Bandwidth	Modulation	RB size	RB offset	Channel	Channel	Channel
				18615	18900	19185
3MHz	QPSK	1	0	21.29	21.49	21.21
		1	8	21.36	21.46	21.38
		1	14	21.33	21.38	21.28
		8	0	20.29	20.5	20.24
		8	4	20.3	20.52	20.16
		8	7	20.36	20.55	20.04
		15	0	20.34	20.45	20.1
	16QAM	1	0	20.25	20.36	20.62
		1	8	20.2	20.42	20.41
		1	14	20.63	20.49	20.25
		8	0	19.42	19.55	19.37
		8	4	19.47	19.55	19.27
		8	7	19.4	19.59	19.25
		15	0	19.43	19.55	19.29



Bandwidth	Modulation	RB size	RB offset	Channel	Channel	Channel
				18625	18900	19175
5MHz	QPSK	1	0	21.25	21.41	21.43
		1	12	21.4	21.45	21.14
		1	24	21.35	21.3	21.17
		12	0	20.31	20.47	20.3
		12	6	20.24	20.39	20.23
		12	13	20.27	20.37	20.01
		25	0	20.39	20.33	20.17
	16QAM	1	0	20	19.92	20.63
		1	12	20.07	19.95	20.47
		1	24	20.36	20.39	20.46
		12	0	19.24	19.48	19.39
		12	6	19.22	19.29	19.4
		12	13	19.36	19.54	19.17
		25	0	19.48	19.53	19.26
Bandwidth	Modulation	RB size	RB offset	Channel	Channel	Channel
				18650	18900	19150
10MHz	QPSK	1	0	21.3	21.39	21.21
		1	24	21.53	21.59	21.47
		1	49	21.45	21.37	21.01
		25	0	20.29	20.58	20.36
		25	12	20.3	20.46	20.33
		25	25	20.43	20.48	20.12
		50	0	20.23	20.44	20.24
	16QAM	1	0	20.33	20.35	20.48
		1	24	20.89	21.05	21.07
		1	49	20.33	20.41	20.43
		25	0	19.46	19.53	19.44
		25	12	19.36	19.54	19.08
		25	25	19.41	19.56	19.22
		50	0	19.4	19.42	19.3
Bandwidth	Modulation	RB size	RB offset	Channel	Channel	Channel
				18675	18900	19125
15MHz	QPSK	1	0	21.45	21.39	21.28
		1	38	21.49	21.51	21.17
		1	74	21.56	21.39	20.94
		36	0	20.33	20.58	20.44
		36	18	20.32	20.39	20.38
		36	37	20.4	20.39	20.38
		75	0	20.37	20.36	20.21
	16QAM	1	0	20.34	20.31	20.45
		1	38	20.67	20.79	20.25
		1	74	20.61	20.44	20.18
		36	0	19.39	19.36	19.43
		36	18	19.27	19.54	19.52



Bandwidth	Modulation	36	37	19.45	19.54	19.4
		75	0	19.35	19.41	19.36
Bandwidth	Modulation	RB size	RB offset	Channel	Channel	Channel
				18700	18900	19100
20MHz	QPSK	1	0	21.31	21.42	21.49
		1	49	21.81	21.81	21.51
		1	99	21.49	21.36	21.06
		50	0	20.3	20.57	20.33
		50	25	20.31	20.49	20.38
		50	50	20.54	20.41	20.3
		100	0	20.43	20.55	20.32
	16QAM	1	0	20.56	20.79	20.43
		1	49	21.09	21.43	20.25
		1	99	20.54	20.83	19.89
		50	0	19.38	19.46	19.59
		50	25	19.47	19.47	19.6
		50	50	19.67	19.42	19.29
		100	0	19.48	19.51	19.44

LTE FDD B4				Conducted Power(dBm)		
Bandwidth	Modulation	RB size	RB offset	Channel	Channel	Channel
				19957	20175	20393
1.4MHz	QPSK	1	0	22.51	22.36	22.39
		1	2	22.48	22.39	22.43
		1	5	22.47	22.33	22.37
		3	0	22.5	22.32	22.21
		3	1	22.5	22.23	22.21
		3	3	22.53	22.3	22.36
		6	0	21.65	21.35	21.46
	16QAM	1	0	21.72	21.79	21.67
		1	2	21.65	21.88	21.92
		1	5	21.44	21.65	21.69
		3	0	21.51	21.32	21.22
		3	1	21.51	21.22	21.11
		3	3	21.69	21.19	21.35
		6	0	20.64	20.5	20.53
Bandwidth	Modulation	RB size	RB offset	Channel	Channel	Channel
				19965	20175	20385
3MHz	QPSK	1	0	22.5	22.27	22.24
		1	8	22.5	22.27	22.25
		1	14	22.56	22.28	22.51
		8	0	21.49	21.37	21.4
		8	4	21.59	21.37	21.33
		8	7	21.52	21.4	21.27



	16QAM	15	0	21.52	21.4	21.3
		1	0	21.51	21.44	21.05
		1	8	21.43	21.33	21.13
		1	14	21.36	21.2	21.25
		8	0	20.67	20.41	20.55
		8	4	20.8	20.41	20.55
		8	7	20.71	20.3	20.61
		15	0	20.7	20.5	20.41
Bandwidth	Modulation	RB size	RB offset	Channel	Channel	Channel
				19975	20175	20375
5MHz	QPSK	1	0	22.59	22.15	22.17
		1	12	22.6	22.37	22.24
		1	24	22.35	22.23	22.43
		12	0	21.58	21.33	21.42
		12	6	21.51	21.45	21.4
		12	13	21.42	21.37	21.5
		25	0	21.46	21.37	21.36
	16QAM	1	0	21.21	21.12	21.09
		1	12	21.25	21.37	20.86
		1	24	21.12	21.44	21.26
		12	0	20.48	20.42	20.37
		12	6	20.49	20.42	20.44
		12	13	20.59	20.39	20.4
		25	0	20.45	20.38	20.47
Bandwidth	Modulation	RB size	RB offset	Channel	Channel	Channel
				20000	20175	20350
10MHz	QPSK	1	0	22.41	22.34	22.29
		1	24	22.62	22.57	22.49
		1	49	22.44	22.39	22.44
		25	0	21.68	21.41	21.48
		25	12	21.53	21.41	21.48
		25	25	21.59	21.4	21.41
		50	0	21.51	21.4	21.33
	16QAM	1	0	21.52	21.47	21.45
		1	24	21.93	21.92	21.92
		1	49	21.65	21.37	21.56
		25	0	20.51	20.39	20.49
		25	12	20.52	20.3	20.5
		25	25	20.65	20.4	20.48
		50	0	20.57	20.45	20.4
Bandwidth	Modulation	RB size	RB offset	Channel	Channel	Channel
				20025	20175	20325
15MHz	QPSK	1	0	22.46	22.31	22.56
		1	38	22.61	22.49	22.54
		1	74	22.5	22.58	22.43



		36	0	21.66	21.47	21.51
		36	18	21.55	21.45	21.46
		36	37	21.55	21.45	21.47
		75	0	21.58	21.4	21.38
	16QAM	1	0	21.63	21.46	21.76
		1	38	21.67	22.14	21.51
		1	74	21.73	21.6	21.47
		36	0	20.54	20.45	20.43
		36	18	20.43	20.45	20.44
		36	37	20.52	20.35	20.55
	75	0	20.61	20.42	20.38	
Bandwidth	Modulation	RB size	RB offset	Channel	Channel	Channel
				20050	20175	20300
20MHz	QPSK	1	0	22.17	22.3	22.42
		1	49	22.79	22.58	22.82
		1	99	22.59	22.47	22.29
		50	0	21.62	21.49	21.77
		50	25	21.55	21.48	21.71
		50	50	21.56	21.5	21.52
		100	0	21.55	21.43	21.52
	16QAM	1	0	21.64	21.86	21.86
		1	49	22	22.23	22
		1	99	21.57	21.88	21.64
		50	0	20.59	20.5	20.76
		50	25	20.73	20.5	20.79
		50	50	20.66	20.46	20.5
		100	0	20.52	20.41	20.54

LTE FDD B5				Conducted Power(dBm)		
Bandwidth	Modulation	RB size	RB offset	Channel	Channel	Channel
				20407	20525	20643
1.4MHz	QPSK	1	0	23.09	22.52	22.85
		1	2	23.02	22.68	22.98
		1	5	23.06	22.56	22.95
		3	0	23.07	22.57	22.67
		3	1	23	22.68	22.79
		3	3	22.88	22.62	22.76
		6	0	22.04	21.77	21.84
	16QAM	1	0	22.33	21.81	21.98
		1	2	22.44	21.7	22.3
		1	5	22.18	21.9	21.95
		3	0	21.93	21.51	21.57
		3	1	22.01	21.5	21.69
		3	3	21.93	21.74	21.68
		6	0	21.15	20.58	20.82



Bandwidth	Modulation	RB size	RB offset	Channel	Channel	Channel
				20415	20525	20635
3MHz	QPSK	1	0	22.94	22.61	22.54
		1	8	23	22.64	22.66
		1	14	23.02	22.54	22.84
		8	0	22.2	21.85	21.66
		8	4	22.12	21.88	21.7
		8	7	22.03	21.75	21.8
		15	0	22.08	21.73	21.65
	16QAM	1	0	21.79	21.81	21.7
		1	8	21.64	21.81	21.72
		1	14	21.75	21.57	21.68
		8	0	21.06	20.89	20.63
		8	4	21.26	20.89	20.64
		8	7	21.02	20.79	20.76
		15	0	20.89	20.64	20.79
Bandwidth	Modulation	RB size	RB offset	Channel	Channel	Channel
				20425	20525	20625
5MHz	QPSK	1	0	22.88	22.75	22.62
		1	12	23.10	22.86	22.69
		1	24	22.98	22.71	22.67
		12	0	22.07	21.78	21.71
		12	6	22.06	21.66	21.62
		12	13	22.05	21.65	21.82
		25	0	21.97	21.69	21.67
	16QAM	1	0	21.51	21.62	21.32
		1	12	21.71	21.54	21.39
		1	24	21.72	21.9	21.45
		12	0	20.98	20.74	20.76
		12	6	21.15	20.74	20.64
		12	13	20.86	20.62	20.72
		25	0	21.11	20.76	20.58
Bandwidth	Modulation	RB size	RB offset	Channel	Channel	Channel
				20450	20525	20600
10MHz	QPSK	1	0	22.86	22.45	22.44
		1	24	23.16	22.95	22.78
		1	49	22.57	22.51	22.68
		25	0	22.03	21.78	21.85
		25	12	22.02	21.77	21.79
		25	25	21.9	21.7	21.64
		50	0	21.88	21.66	21.7
	16QAM	1	0	22.01	21.61	21.58
		1	24	22.14	22.12	21.91
		1	49	21.75	21.52	21.69
		25	0	21.07	20.91	20.79



		25	12	21.1	20.9	20.79
		25	25	20.92	20.65	20.72
		50	0	20.92	20.49	20.69

LTE FDD B7				Conducted Power(dBm)		
Bandwidth	Modulation	RB size	RB offset	Channel	Channel	Channel
				20775	21100	21425
5MHz	QPSK	1	0	21.21	21	20.84
		1	12	21.22	21.38	21.27
		1	24	21.09	21.32	21.37
		12	0	20.44	20.24	20.21
		12	6	20.44	20.25	20.21
		12	13	20.5	20.36	20.28
		25	0	20.47	20.24	20.24
	16QAM	1	0	19.71	19.85	19.9
		1	12	19.83	19.96	19.77
		1	24	19.75	19.92	19.97
		12	0	19.49	19.41	19.26
		12	6	19.3	19.3	19.38
		12	13	19.42	19.22	19.33
		25	0	19.53	19.32	19.21
Bandwidth	Modulation	RB size	RB offset	Channel	Channel	Channel
				20800	21100	21400
10MHz	QPSK	1	0	20.47	20.29	20.22
		1	24	21.02	20.74	20.56
		1	49	20.31	20.21	20.35
		25	0	19.35	19.5	19.37
		25	12	19.35	19.51	19.28
		25	25	19.49	19.32	19.42
		50	0	19.47	19.39	19.38
	16QAM	1	0	21.30	21.09	21.04
		1	24	21.32	21.31	21.30
		1	49	21.29	21.21	21.15
		25	0	20.44	20.45	20.38
		25	12	20.45	20.34	20.32
		25	25	20.45	20.36	20.3
		50	0	20.34	20.34	20.34
Bandwidth	Modulation	RB size	RB offset	Channel	Channel	Channel
				20825	21100	21375
15MHz	QPSK	1	0	21.47	21.24	21.12
		1	38	21.43	21.35	21.19
		1	74	21.31	21.3	21.18
		36	0	20.39	20.4	20.38
		36	18	20.38	20.34	20.33



Bandwidth	Modulation	36	37	20.38	20.34	20.34
		75	0	20.43	20.35	20.31
20MHz	16QAM	1	0	20.54	20.34	20.28
		1	38	20.35	20.38	20.27
		1	74	20.29	20.22	20.4
		36	0	19.32	19.47	19.2
		36	18	19.41	19.29	19.31
		36	37	19.41	19.35	19.31
		75	0	19.45	19.37	19.32
		RB size	RB offset	Channel	Channel	Channel
				20850	21100	21350
		20MHz	QPSK	1	0	21.17
1	49			21.69	21.66	21.51
1	99			21.02	21.38	21.03
50	0			20.35	20.37	20.43
50	25			20.32	20.32	20.39
50	50			20.43	20.39	20.31
100	0			20.35	20.36	20.39
16QAM	1		0	20.59	20.4	20.08
	1		49	20.83	21.01	20.88
	1		99	20.41	20.41	20.63
	50		0	19.43	19.45	19.34
	50		25	19.51	19.45	19.35
	50		50	19.49	19.35	19.37
	100		0	19.38	19.36	19.34

LTE FDD B25				Conducted Power(dBm)		
Bandwidth	Modulation	RB size	RB offset	Channel	Channel	Channel
				26047	26365	26683
1.4MHz	QPSK	1	0	22.01	22.18	21.64
		1	2	22.06	22.28	21.6
		1	5	21.92	22.34	21.12
		3	0	22.01	22.25	21.87
		3	1	22.02	22.17	21.75
		3	3	21.91	22.23	21.21
		6	0	20.99	21.13	20.91
	16QAM	1	0	21.13	21.51	20.97
		1	2	21.34	21.85	20.79
		1	5	21.35	21.48	20.29
		3	0	20.8	21.07	21
		3	1	20.9	21.16	20.97
		3	3	20.9	21.22	20.23
		6	0	19.92	20.38	19.91
Bandwidth	Modulation			Channel	Channel	Channel



		RB size	RB offset	26055	26365	26675
3MHz	QPSK	1	0	21.88	22.19	21.65
		1	8	22.04	22.28	21.58
		1	14	22.02	22.25	21.34
		8	0	21.03	21.21	20.97
		8	4	21.06	21.23	20.94
		8	7	21.04	21.26	20.74
		15	0	20.94	21.16	20.72
	16QAM	1	0	20.9	21.13	20.99
		1	8	20.88	21.06	20.55
		1	14	20.83	21.16	20.37
		8	0	20.08	20.44	19.92
		8	4	20.09	20.45	20.02
		8	7	20.18	20.4	20.03
		15	0	20.12	20.18	19.95
Bandwidth	Modulation	RB size	RB offset	Channel 26065	Channel 26365	Channel 26665
5MHz	QPSK	1	0	22	22.08	21.75
		1	12	22.12	22.4	21.93
		1	24	22.07	22.14	21.51
		12	0	21.05	21.19	20.74
		12	6	21.07	21.21	20.79
		12	13	21.04	21.27	20.78
		25	0	20.98	21.13	20.8
	16QAM	1	0	20.69	20.84	21.08
		1	12	20.73	20.9	20.62
		1	24	21.27	20.79	20.66
		12	0	20.06	20.06	19.78
		12	6	20.07	20.04	19.86
		12	13	19.93	20.17	19.93
		25	0	19.98	20.39	19.89
Bandwidth	Modulation	RB size	RB offset	Channel 26090	Channel 26365	Channel 26640
10MHz	QPSK	1	0	21.96	22.04	21.69
		1	24	22.2	22.31	21.6
		1	49	22.01	22.32	20.92
		25	0	21.04	21.33	20.75
		25	12	21.05	21.27	20.79
		25	25	21.19	21.35	20.84
		50	0	21.09	21.21	20.75
	16QAM	1	0	21.01	21.09	20.93
		1	24	21.35	21.35	20.95
		1	49	21.15	21.35	20.03
		25	0	20.11	20.24	19.81



Bandwidth	Modulation	25	12	20.13	20.22	19.98
		25	25	20.16	20.33	20.1
		50	0	20.15	20.08	19.77
Bandwidth	Modulation	RB size	RB offset	Channel	Channel	Channel
				26115	26365	26615
15MHz	QPSK	1	0	21.98	21.96	21.83
		1	38	22.13	22.39	21.46
		1	74	22.09	22.26	20.98
		36	0	21.04	21.29	20.96
		36	18	21.04	21.31	20.93
		36	37	21.04	21.32	20.93
		75	0	21.12	21.21	20.8
	16QAM	1	0	21.19	21.1	20.92
		1	38	21.09	21.35	20.35
		1	74	21	21.43	20.3
		36	0	20.11	20.21	19.97
		36	18	20.02	20.21	19.87
		36	37	20.11	20.21	19.87
		75	0	20.1	20.21	19.84
Bandwidth	Modulation	RB size	RB offset	Channel	Channel	Channel
				26140	26365	26590
20MHz	QPSK	1	0	21.89	22.01	21.97
		1	49	22.58	22.51	21.92
		1	99	22.13	22.22	20.97
		50	0	21.18	21.27	21.18
		50	25	21.19	21.29	21.12
		50	50	21.07	21.35	20.79
		100	0	21.1	21.28	20.98
	16QAM	1	0	21.14	21.54	20.97
		1	49	21.84	21.87	20.82
		1	99	21.05	21.69	20.11
		50	0	20.25	20.27	20.22
		50	25	20.15	20.27	20.18
		50	50	20.16	20.36	19.83
		100	0	20.07	20.26	20.02



LTE FDD B26(814-824)				Conducted Power(dBm)		
Bandwidth	Modulation	RB size	RB offset	Channel	Channel	Channel
				26697	26740	26783
1.4MHz	QPSK	1	0	22.72	22.61	22.9
		1	2	22.77	23.1	23.11
		1	5	22.92	23.1	22.92
		3	0	22.76	22.82	22.89
		3	1	22.65	22.8	22.79
		3	3	22.75	22.88	22.87
		6	0	21.72	21.9	22.05
	16QAM	1	0	22.15	22.12	22.13
		1	2	22.19	22.17	22.20
		1	5	22.03	22.11	22.09
		3	0	21.9	22.06	21.92
		3	1	21.59	22.04	22.1
		3	3	22.04	22.15	22.19
		6	0	21.21	21.13	21.26
Bandwidth	Modulation	RB size	RB offset	Channel	Channel	Channel
3MHz	QPSK	1	0	22.81	22.66	22.72
		1	8	23	22.98	22.92
		1	14	23.04	22.92	23.01
		8	0	21.88	21.91	21.83
		8	4	21.83	21.84	21.84
		8	7	22.04	21.84	21.95
		15	0	21.98	21.86	21.83
	16QAM	1	0	21.91	22.11	22
		1	8	22.17	22.37	22.06
		1	14	22.09	22.4	22.17
		8	0	21.18	21.26	21.19
		8	4	21.19	21.16	21.34
		8	7	21.38	21.27	21.37
		15	0	21.3	21.17	21.13
Bandwidth	Modulation	RB size	RB offset	Channel	Channel	Channel
5MHz	QPSK	1	0	22.7	22.74	22.69
		1	12	22.99	23.05	22.9
		1	24	22.72	23.01	22.8
		12	0	21.94	21.75	21.9
		12	6	21.86	21.87	21.9
		12	13	21.86	21.97	21.92
		25	0	21.77	21.85	21.89
	16QAM	1	0	21.7	22.02	21.84
		1	12	21.94	21.99	21.8
		1	12	21.94	21.99	21.8
Bandwidth	Modulation	RB size	RB offset	Channel	Channel	Channel
5MHz	QPSK	1	0	22.7	22.74	22.69
		1	12	22.99	23.05	22.9
		1	24	22.72	23.01	22.8
		12	0	21.94	21.75	21.9
		12	6	21.86	21.87	21.9
		12	13	21.86	21.97	21.92
		25	0	21.77	21.85	21.89
	16QAM	1	0	21.7	22.02	21.84
		1	12	21.94	21.99	21.8
		1	12	21.94	21.99	21.8



		1	24	21.85	22.18	21.92
		12	0	21.18	21.15	20.99
		12	6	21.29	21.25	21.29
		12	13	21.05	21.35	21.24
		25	0	21.29	21.34	21.2
Bandwidth	Modulation	RB size	RB offset	Channel		
				26740		
10MHz	QPSK	1	0	22.72		
		1	24	22.93		
		1	49	22.94		
		25	0	21.82		
		25	12	21.83		
		25	25	22.05		
		50	0	21.9		
	16QAM	1	0	22.14		
		1	24	22.41		
		1	49	22.24		
		25	0	21.02		
		25	12	21.22		
		25	25	21.25		
		50	0	21.29		

LTE FDD B26(824-849)				Conducted Power(dBm)		
Bandwidth	Modulation	RB size	RB offset	Channel	Channel	Channel
				26797	26915	27033
1.4MHz	QPSK	1	0	23.05	22.48	22.7
		1	2	22.89	22.88	22.62
		1	5	23	22.75	22.7
		3	0	22.91	22.66	22.53
		3	1	22.97	22.58	22.63
		3	3	22.91	22.52	22.58
		6	0	22.01	21.61	21.63
	16QAM	1	0	22.13	21.84	22.14
		1	2	22.21	22.01	22.18
		1	5	22.12	22.13	22.01
		3	0	22.08	21.75	21.66
		3	1	22.18	21.75	21.66
		3	3	22.15	21.88	21.65
		6	0	21.34	20.89	20.92
Bandwidth	Modulation	RB size	RB offset	Channel	Channel	Channel
				26805	26915	27025
3MHz	QPSK	1	0	22.89	22.64	22.61
		1	8	22.87	22.55	22.44
		1	14	22.91	22.57	22.55



		8	0	21.95	21.59	21.68
		8	4	21.97	21.73	21.62
		8	7	21.92	21.6	21.58
		15	0	22.01	21.57	21.55
	16QAM	1	0	22.13	22.01	21.74
		1	8	21.58	21.96	21.69
		1	14	22.08	21.9	21.67
		8	0	21.2	20.99	20.9
		8	4	21.15	21	20.91
		8	7	21.23	20.87	20.9
		15	0	21.27	20.84	20.89
Bandwidth	Modulation	RB size	RB offset	Channel	Channel	Channel
				26815	26915	27015
5MHz	QPSK	1	0	22.69	22.54	22.42
		1	12	22.6	22.58	22.43
		1	24	22.49	22.46	22.32
		12	0	21.92	21.63	21.65
		12	6	21.9	21.64	21.59
		12	13	21.92	21.6	21.55
		25	0	21.88	21.65	21.6
	16QAM	1	0	21.62	21.7	21.1
		1	12	21.62	21.65	21.46
		1	24	21.69	21.66	21.48
		12	0	21.25	20.84	20.73
		12	6	21.14	20.96	20.74
		12	13	21.11	20.85	20.77
		25	0	21.26	20.76	21
Bandwidth	Modulation	RB size	RB offset	Channel	Channel	Channel
				26840	26915	26990
10MHz	QPSK	1	0	22.54	22.48	22.47
		1	24	22.75	22.5	22.48
		1	49	22.52	22.44	22.39
		25	0	21.94	21.7	21.75
		25	12	22.03	21.7	21.7
		25	25	21.76	21.67	21.62
		50	0	21.87	21.65	21.61
	16QAM	1	0	22.09	21.82	21.84
		1	24	22.06	22.11	22.02
		1	49	21.82	21.7	21.78
		25	0	21.24	20.96	20.92
		25	12	21.06	20.97	20.8
		25	25	20.89	20.85	20.84
		50	0	20.95	20.8	20.84
Bandwidth	Modulation	RB size	RB offset	Channel	Channel	Channel
				26865	26915	26965



15MHz	QPSK	1	0	22.6	22.53	22.63
		1	38	22.71	22.45	22.45
		1	74	22.67	22.31	22.45
		36	0	21.8	21.7	21.69
		36	18	21.91	21.72	21.72
		36	37	21.8	21.72	21.72
		75	0	21.84	21.64	21.58
	16QAM	1	0	22.22	21.94	22.09
		1	38	22.07	21.5	21.91
		1	74	21.99	21.61	21.75
		36	0	21.03	21.02	20.83
		36	18	20.89	21.02	20.93
		36	37	21.03	21.02	20.94
		75	0	21.03	20.85	20.79

LTE FDD B38				Conducted Power(dBm)		
Bandwidth	Modulation	RB size	RB offset	Channel	Channel	Channel
				37775	38000	38225
5MHz	QPSK	1	0	21.25	21.36	21.36
		1	12	21.25	21.51	21.77
		1	24	21.25	21.38	21.4
		12	0	20.36	20.49	20.61
		12	6	20.38	20.51	20.63
		12	13	20.34	20.5	20.72
		25	0	20.28	20.47	20.63
	16QAM	1	0	20.21	20.47	21
		1	12	20.37	20.76	21.09
		1	24	20.29	20.51	21.14
		12	0	19.31	19.36	19.52
		12	6	19.41	19.37	19.53
		12	13	19.24	19.47	19.62
		25	0	19.32	19.4	19.63
Bandwidth	Modulation	RB size	RB offset	Channel	Channel	Channel
10MHz	QPSK	1	0	21.15	21.12	21.55
		1	24	21.19	21.52	21.8
		1	49	21.24	21.44	21.85
		25	0	20.27	20.51	20.59
		25	12	20.27	20.41	20.61
		25	25	20.42	20.47	20.55
		50	0	20.29	20.5	20.55
	16QAM	1	0	20.54	19.92	21.18
		1	24	20.45	20.96	21.28
		1	49	20.36	20.7	21.34
		1	49	20.36	20.7	21.34



		25	0	19.23	19.42	19.56
		25	12	19.25	19.42	19.66
		25	25	19.21	19.55	19.55
		50	0	19.42	19.43	19.55
Bandwidth	Modulation	RB size	RB offset	Channel	Channel	Channel
				37825	38000	38175
15MHz	QPSK	1	0	21.06	21.23	21.55
		1	38	21.19	21.54	21.62
		1	74	21.13	21.42	21.82
		36	0	20.3	20.5	20.63
		36	18	20.29	20.45	20.53
		36	37	20.29	20.43	20.53
		75	0	20.36	20.43	20.59
	16QAM	1	0	20.55	20.41	20.76
		1	38	20.51	20.45	20.77
		1	74	20.22	20.46	20.94
		36	0	19.22	19.4	19.56
		36	18	19.21	19.51	19.46
		36	37	19.21	19.51	19.67
		75	0	19.42	19.47	19.63
Bandwidth	Modulation	RB size	RB offset	Channel	Channel	Channel
				37850	38000	38150
20MHz	QPSK	1	0	21.17	21.47	21.41
		1	49	21.4	21.86	21.63
		1	99	21.26	21.63	21.59
		50	0	20.33	20.51	20.53
		50	25	20.33	20.47	20.54
		50	50	20.46	20.53	20.59
		100	0	20.33	20.48	20.53
	16QAM	1	0	20.83	20.53	20.26
		1	49	21.27	20.73	20.6
		1	99	20.79	20.52	20.46
		50	0	19.38	19.37	19.54
		50	25	19.38	19.56	19.54
		50	50	19.51	19.71	19.49
		100	0	19.41	19.51	19.57



LTE FDD B41				Conducted Power(dBm)		
Bandwidth	Modulation	RB size	RB offset	Channel	Channel	Channel
				39675	40620	41565
5MHz	QPSK	1	0	21.44	21.39	22.1
		1	12	21.58	21.66	22.19
		1	24	21.52	21.44	22.01
		12	0	20.61	20.55	21.22
		12	6	20.61	20.55	21.24
		12	13	20.65	20.59	21.17
		25	0	20.64	20.62	21.25
	16QAM	1	0	20.51	20.6	21.4
		1	12	20.86	20.76	21.54
		1	24	20.77	20.71	21.52
		12	0	19.62	19.57	20.25
		12	6	19.62	19.57	20.15
		12	13	19.55	19.6	20.2
		25	0	19.66	19.66	20.32
Bandwidth	Modulation	RB size	RB offset	Channel	Channel	Channel
				39700	40620	41540
10MHz	QPSK	1	0	21.42	21.39	22.17
		1	24	21.73	21.58	22.15
		1	49	21.64	21.48	22.13
		25	0	20.62	20.61	21.36
		25	12	20.62	20.61	21.29
		25	25	20.79	20.72	21.18
		50	0	20.69	20.62	21.33
	16QAM	1	0	20.9	20.53	21.48
		1	24	20.83	20.89	21.77
		1	49	20.95	20.89	21.43
		25	0	19.69	19.6	20.36
		25	12	19.64	19.7	20.54
		25	25	19.77	19.82	20.36
		50	0	19.82	19.64	20.32
Bandwidth	Modulation	RB size	RB offset	Channel	Channel	Channel
				39725	40620	41515
15MHz	QPSK	1	0	21.3	21.25	22.15
		1	38	21.49	21.52	22.27
		1	74	21.43	21.29	22.1
		36	0	20.51	20.56	21.34
		36	18	20.51	20.58	21.26
		36	37	20.51	20.55	21.26
		75	0	20.49	20.61	21.28
	16QAM	1	0	20.69	20.64	21.03
		1	38	20.79	20.84	21.14



		1	74	20.52	20.5	21.07
		36	0	19.55	19.61	20.4
		36	18	19.55	19.61	20.39
		36	37	19.55	19.6	20.39
		75	0	19.53	19.66	20.44
Bandwidth	Modulation	RB size	RB offset	Channel	Channel	Channel
				39750	40620	41490
20MHz	QPSK	1	0	21.24	21.12	22.27
		1	49	21.74	21.5	22.68
		1	99	21.5	21.41	22.4
		50	0	20.57	20.57	21.19
		50	25	20.58	20.57	21.3
		50	50	20.7	20.72	21.4
		100	0	20.6	20.66	21.39
	16QAM	1	0	20.94	20.99	21.2
		1	49	21.44	21.44	21.57
		1	99	21.18	21.02	21.23
		50	0	19.61	19.73	20.21
		50	25	19.61	19.73	20.41
		50	50	19.74	19.77	20.55
		100	0	19.61	19.69	20.46

8. RADIATED SPURIOUS EMISSIONS

RULE PART(S)

FCC: §2.1053, §22.917, §24.238, §27.53, §90,
RSS-130, RSS-132, RSS-133, RSS-139, RSS-195, RSS-199

LIMIT

Part §22.917(a), §24.238(a), §27.53(h)

The power of any emission outside of the authorized operating frequency ranges must be attenuated below the transmitting power (P) by a factor of at least $43 + 10 \log(P)$ dB.

RSS-132 section 5.5

Mobile and base station equipment shall comply with the limits in (i) and (ii) below.

(i) In the first 1.0 MHz band immediately outside and adjacent to each of the sub-bands specified in Section 5.1, the power of emissions per any 1% of the occupied bandwidth shall be attenuated (in dB) below the transmitter output power P (dBW) by at least $43 + 10 \log_{10} p$ (watts).

(ii) After the first 1.0 MHz immediately outside and adjacent to each of the sub-bands, the power of emissions in any 100 kHz bandwidth shall be attenuated (in dB) below the transmitter output power P (dBW) by at least $43 + 10 \log_{10} p$ (watts). If the measurement is performed using 1% of the occupied bandwidth, power integration over 100 kHz is required.

RSS-133 section 6.5.1

Equipment shall comply with the limits in (i) and (ii) below.

(i) In the 1.0 MHz bands immediately outside and adjacent to the equipment's operating frequency block, the emission power per any 1% of the emission bandwidth shall be attenuated (in dB) below the transmitter output power P (dBW) by at least $43 + 10 \log_{10} p$ (watts).

(ii) After the first 1.0 MHz, the emission power in any 1 MHz bandwidth shall be attenuated (in dB) below the transmitter output power P (dBW) by at least $43 + 10 \log_{10} p$ (watts). If the measurement is performed using 1% of the emission bandwidth, power integration over 1.0 MHz is required.

RSS-139 section 6.6

(i) In the first 1.0 MHz bands immediately outside and adjacent to the equipment's smallest operating frequency block,² which can contain the equipment's occupied bandwidth, the emission power per any 1% of the emission bandwidth shall be attenuated below the transmitter output power P (in dBW) by at least $43 + 10 \log_{10} p$ (watts) dB.

(ii) After the first 1.0 MHz outside the equipment's smallest operating frequency block, which can contain the equipment's occupied bandwidth, the emission power in any 1 MHz bandwidth shall be attenuated below the transmitter output power P (in dBW) by at least $43 + 10 \log_{10} p$ (watts) dB.

For Band 13, 1559-1610 MHz shall be limited to -70 dBW/MHz EIRP for wideband signals and -80 dBW EIRP for discrete emissions of less than 700 Hz bandwidth.

TEST PROCEDURE

According to the C 63.26-2015 section 5.5.2.2.3

Below 1GHz test procedure as below:

For radiated emissions measurements performed at frequencies less than or equal to 1 GHz, the EUT shall be placed on a RF-transparent table or support at a nominal height of 80 cm above the reference ground plane. Radiated measurements shall be made with the measurement antenna positioned in both horizontal and vertical polarization. The measurement antenna shall be varied from 1 m to 4 m in height above the reference ground in a search for the relative positioning that produces the maximum radiated signal level (i.e., field strength or received power). When orienting the measurement antenna in vertical polarization, the minimum height of the lowest element of the antenna shall clear the site reference ground plane by at least 25 cm.

Above 1GHz test procedure as below:

For radiated measurements performed at frequencies above 1 GHz, the EUT shall be placed on an RF transparent table or support at a nominal height of 1.5 m above the ground plane. Radiated measurements shall be made with the measurement antenna positioned in both horizontal and vertical polarization. The height scan of the measurement antenna shall be varied from 1 m to 4 m in a search for the relative positioning that produces the maximum radiated signal level (i.e., field strength or received power). When using the direct field strength method and the EUT is manipulated through three different orientations, then the scan height range of the measurement antenna is limited to 2.5 m, or 0.5 m above the top of the EUT, whichever is higher.

Radiated Power Measurement Calculation According to ANSI C63.26-2015

a) E (dB μ V/m) = Measured amplitude level (dB μ V) + Cable Loss (dB) + Antenna Factor (dB/m).

b) E (dB μ V/m) = Measured amplitude level (dBm) + 107 + Cable Loss (dB) + Antenna Factor (dB/m).

c) E (dB μ V/m) = EIRP (dBm) - 20log(D) + 104.8; where D is the measurement distance (in the far field region) in m.

d) EIRP (dBm) = E (dB μ V/m) + 20log(D) - 104.8; where D is the measurement distance (in the far field region) in m.

So, from d)

The measuring distance is usually at 3m, then $20 \cdot \log(3) = 9.5424$

Then, EIRP (dBm) = E (dB μ V/m) + 9.5424 - 104.8 = E (dB μ V/m) - 95.2576

The limit line is derived from $43 + 10\log(P)$ dB below the transmitter power P(Watts)
= $P(W) - [43 + 10\log(P)]$ (dB)
= $[30 + 10\log(P)]$ (dBm) - $[43 + 10\log(P)]$ (dB)
= -13dBm.

EIRP[dBm] = E [dB μ V/m] - 95.2

E [dB μ V/m] = 95.2 + EIRP[dBm]

E [dB μ V/m] = 82.20

NOTE 1: Radiated spurious emissions were investigated below 30 MHz, 30 MHz – 1 GHz and above 1 GHz. There were no emissions found on below 30 MHz and 30 MHz – 1 GHz. Although these tests were performed other than open area test site, adequate comparison measurements were confirmed against 30 m open area test site. Therefore sufficient tests were made to demonstrate that the alternative site produces results that correlate with the one of tests made in an open field based on KDB 414788.

NOTE 2: Please refer to section 5 for bandwidth and RB setting about LTE bands.

NOTE 3: All the test modes have been tested, only the worst data record in the report.

Note 4: For all radiated test, EUT in each of three orthogonal axis emissions had been tested, but only the worst case (X axis) data recorded in the report.
X axis, Y axis, Z axis positions:

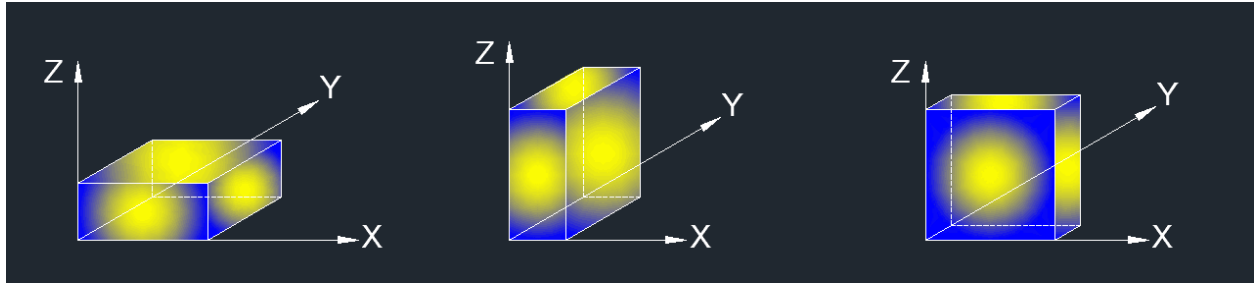

TEST SETUP

Test Setup for Below 1 GHz

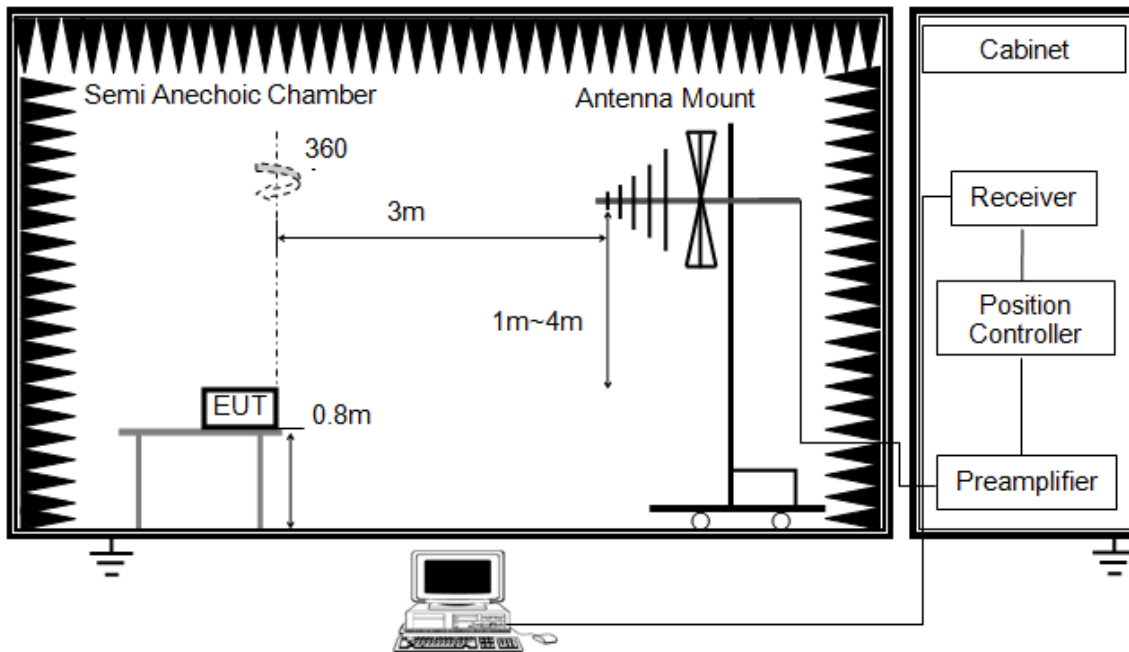

Test Setup for Above 1 GHz

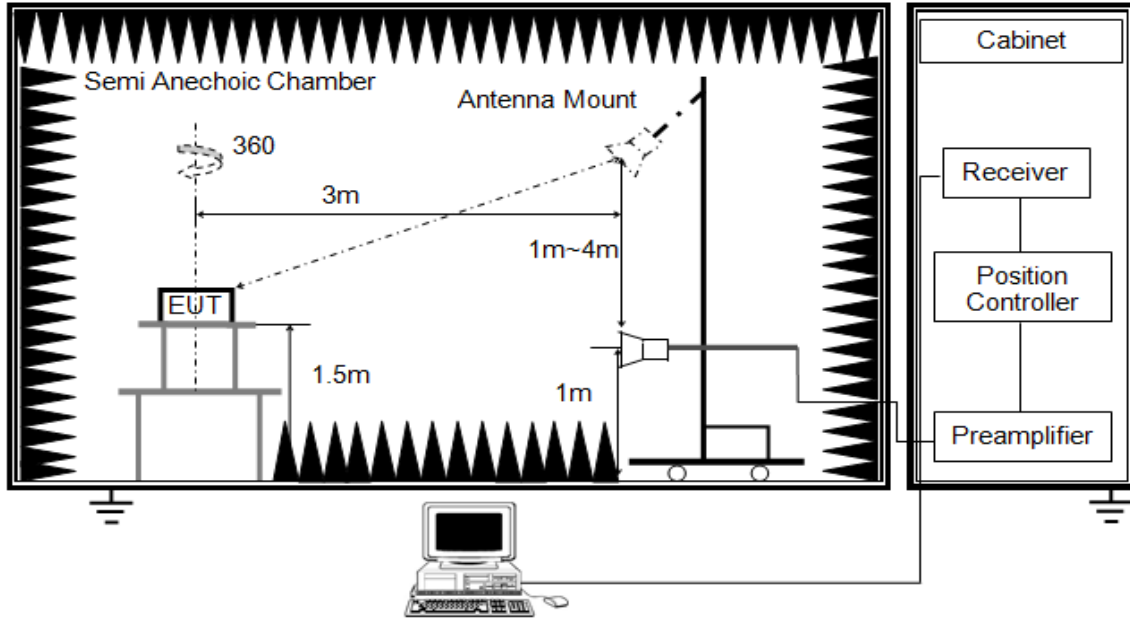

TEST ENVIRONMENT

Temperature	22.3°C	Relative Humidity	64%
Atmosphere Pressure	101kPa	Test Voltage	DC 5.8 V

RESULTS



TE Band 2

QPSK-20 MHz-Low Channel- Horizontal(worst case)

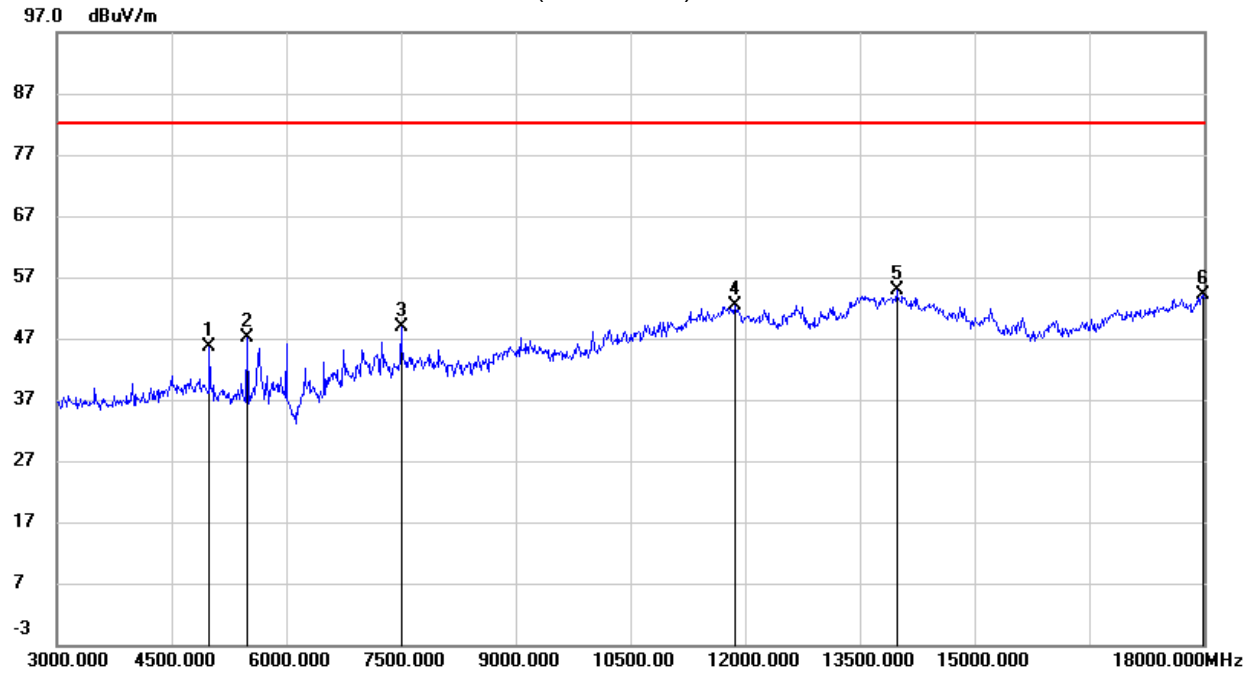

No.	Frequency (MHz)	Reading (dBuV)	Correct (dB/m)	Result (dBuV/m)	Limit (dBuV/m)	Margin (dB)	Remark
1	5490.000	45.42	0.84	46.26	82.25	-35.99	peak
2	6000.000	44.46	2.25	46.71	82.25	-35.54	peak
3	7500.000	42.07	6.33	48.40	82.25	-33.85	peak
4	11415.000	35.90	16.29	52.19	82.25	-30.06	peak
5	14115.000	33.35	21.49	54.84	82.25	-27.41	peak
6	17865.000	28.73	24.89	53.62	82.25	-28.63	peak



QPSK-20 MHz-Low Channel-Vertical

No.	Frequency (MHz)	Reading (dBuV)	Correct (dB/m)	Result (dBuV/m)	Limit (dBuV/m)	Margin (dB)	Remark
1	4995.000	46.49	0.43	46.92	82.25	-35.33	peak
2	6750.000	41.78	5.45	47.23	82.25	-35.02	peak
3	7500.000	43.93	6.33	50.26	82.25	-31.99	peak
4	10005.000	38.37	12.02	50.39	82.25	-31.86	peak
5	13560.000	33.79	21.04	54.83	82.25	-27.42	peak
6	17985.000	29.03	25.60	54.63	82.25	-27.62	peak

QPSK-20 MHz-Mid Channel- Horizontal

No.	Frequency (MHz)	Reading (dBuV)	Correct (dB/m)	Result (dBuV/m)	Limit (dBuV/m)	Margin (dB)	Remark
1	4995.000	45.17	0.43	45.60	82.25	-36.65	peak
2	5490.000	46.27	0.84	47.11	82.25	-35.14	peak
3	7500.000	42.62	6.33	48.95	82.25	-33.30	peak
4	11865.000	34.77	17.59	52.36	82.25	-29.89	peak
5	13980.000	32.86	21.92	54.78	82.25	-27.47	peak
6	17985.000	28.58	25.60	54.18	82.25	-28.07	peak

QPSK-20 MHz- Mid Channel-Vertical

No.	Frequency (MHz)	Reading (dBuV)	Correct (dB/m)	Result (dBuV/m)	Limit (dBuV/m)	Margin (dB)	Remark
1	5640.000	46.66	1.24	47.90	82.25	-34.35	peak
2	7515.000	43.49	6.33	49.82	82.25	-32.43	peak
3	10005.000	38.30	12.02	50.32	82.25	-31.93	peak
4	11715.000	35.35	17.19	52.54	82.25	-29.71	peak
5	13950.000	33.00	21.86	54.86	82.25	-27.39	peak
6	17970.000	28.68	25.51	54.19	82.25	-28.06	peak



QPSK-20 MHz-High Channel- Horizontal

No.	Frequency (MHz)	Reading (dBuV)	Correct (dB/m)	Result (dBuV/m)	Limit (dBuV/m)	Margin (dB)	Remark
1	6000.000	44.01	2.25	46.26	82.25	-35.99	peak
2	7500.000	42.53	6.33	48.86	82.25	-33.39	peak
3	10005.000	37.36	12.02	49.38	82.25	-32.87	peak
4	11835.000	35.03	17.51	52.54	82.25	-29.71	peak
5	13980.000	33.00	21.92	54.92	82.25	-27.33	peak
6	17985.000	29.39	25.60	54.99	82.25	-27.26	peak

QPSK-20 MHz- High Channel-Vertical

No.	Frequency (MHz)	Reading (dBuV)	Correct (dB/m)	Result (dBuV/m)	Limit (dBuV/m)	Margin (dB)	Remark
1	4995.000	47.93	0.43	48.36	82.25	-33.89	peak
2	5685.000	46.16	1.37	47.53	82.25	-34.72	peak
3	7590.000	44.71	6.32	51.03	82.25	-31.22	peak
4	11895.000	34.38	17.68	52.06	82.25	-30.19	peak
5	13815.000	33.16	21.56	54.72	82.25	-27.53	peak
6	17700.000	29.59	23.91	53.50	82.25	-28.75	peak

Note: Limit= -13dBm+95.2=82.25 dBuV/m

**LTE Band 4**

QPSK-20 MHz-Low Channel- Horizontal

No.	Frequency (MHz)	Reading (dBuV)	Correct (dB/m)	Result (dBuV/m)	Limit (dBuV/m)	Margin (dB)	Remark
1	5160.000	49.24	0.58	49.82	82.25	-32.43	peak
2	7500.000	41.74	6.33	48.07	82.25	-34.18	peak
3	10005.000	37.43	12.02	49.45	82.25	-32.80	peak
4	11700.000	35.26	17.14	52.40	82.25	-29.85	peak
5	13620.000	33.83	21.15	54.98	82.25	-27.27	peak
6	17715.000	30.20	24.00	54.20	82.25	-28.05	peak

QPSK-20 MHz-Low Channel- Vertical

No.	Frequency (MHz)	Reading (dBuV)	Correct (dB/m)	Result (dBuV/m)	Limit (dBuV/m)	Margin (dB)	Remark
1	5160.000	49.95	0.58	50.53	82.25	-31.72	peak
2	7500.000	42.25	6.33	48.58	82.25	-33.67	peak
3	10005.000	37.75	12.02	49.77	82.25	-32.48	peak
4	11895.000	34.89	17.68	52.57	82.25	-29.68	peak
5	13635.000	33.72	21.19	54.91	82.25	-27.34	peak
6	17955.000	29.24	25.42	54.66	82.25	-27.59	peak

QPSK-20 MHz-Mid Channel- Horizontal

No.	Frequency (MHz)	Reading (dBuV)	Correct (dB/m)	Result (dBuV/m)	Limit (dBuV/m)	Margin (dB)	Remark
1	4995.000	45.40	0.43	45.83	82.25	-36.42	peak
2	6000.000	44.73	2.25	46.98	82.25	-35.27	peak
3	7500.000	42.14	6.33	48.47	82.25	-33.78	peak
4	12300.000	34.75	17.74	52.49	82.25	-29.76	peak
5	13635.000	33.33	21.19	54.52	82.25	-27.73	peak
6	17595.000	30.64	23.29	53.93	82.25	-28.32	peak

QPSK-20 MHz-Mid Channel- Vertical

No.	Frequency (MHz)	Reading (dBuV)	Correct (dB/m)	Result (dBuV/m)	Limit (dBuV/m)	Margin (dB)	Remark
1	4995.000	47.79	0.43	48.22	82.25	-34.03	peak
2	7500.000	41.70	6.33	48.03	82.25	-34.22	peak
3	10005.000	38.66	12.02	50.68	82.25	-31.57	peak
4	11820.000	34.59	17.47	52.06	82.25	-30.19	peak
5	13605.000	33.39	21.12	54.51	82.25	-27.74	peak
6	17910.000	28.73	25.16	53.89	82.25	-28.36	peak



QPSK-20 MHz-High Channel- Horizontal

No.	Frequency (MHz)	Reading (dBuV)	Correct (dB/m)	Result (dBuV/m)	Limit (dBuV/m)	Margin (dB)	Remark
1	4995.000	45.67	0.43	46.10	82.25	-36.15	peak
2	6000.000	44.10	2.25	46.35	82.25	-35.90	peak
3	7500.000	42.94	6.33	49.27	82.25	-32.98	peak
4	11820.000	35.06	17.47	52.53	82.25	-29.72	peak
5	14010.000	32.23	21.93	54.16	82.25	-28.09	peak
6	17985.000	28.29	25.60	53.89	82.25	-28.36	peak

QPSK-20 MHz-High Channel- Vertical(worst case)

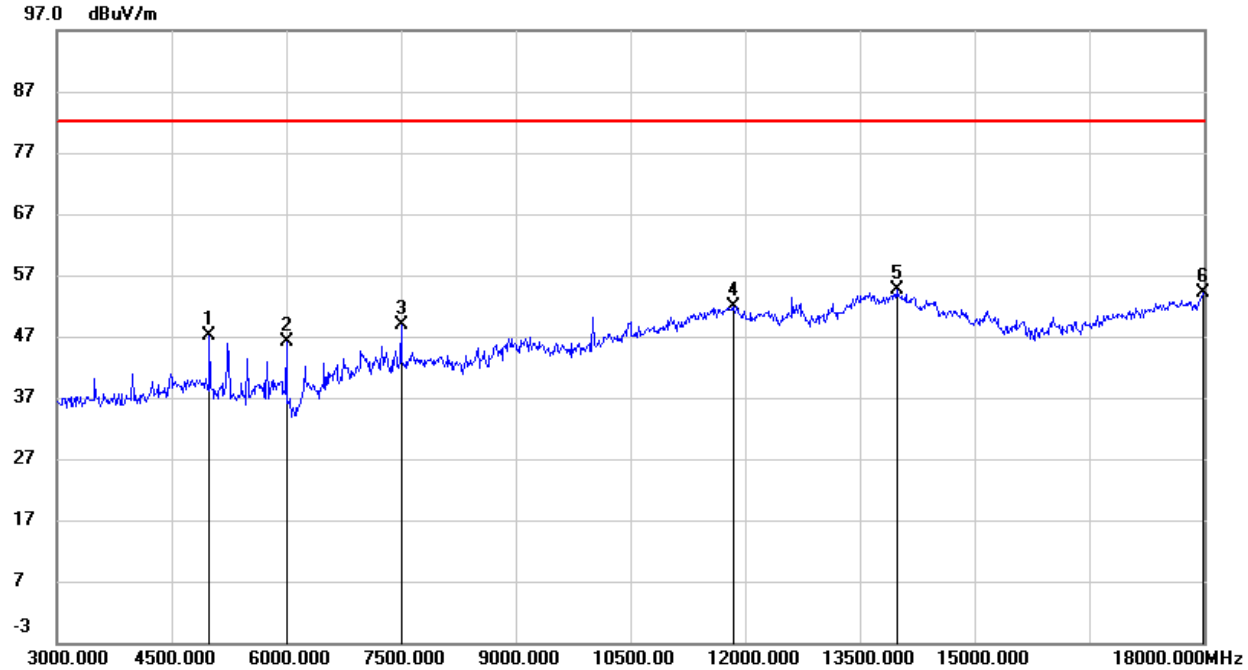

No.	Frequency (MHz)	Reading (dBuV)	Correct (dB/m)	Result (dBuV/m)	Limit (dBuV/m)	Margin (dB)	Remark
1	4995.000	46.81	0.43	47.24	82.25	-35.01	peak
2	6000.000	43.84	2.25	46.09	82.25	-36.16	peak
3	7500.000	42.45	6.33	48.78	82.25	-33.47	peak
4	11850.000	34.25	17.56	51.81	82.25	-30.44	peak
5	13980.000	32.63	21.92	54.55	82.25	-27.70	peak
6	17985.000	28.44	25.60	54.04	82.25	-28.21	peak

Note: Limit= -13dBm+95.2=82.25 dBuV/m



LTE Band 5

QPSK-10 MHz-Low Channel- Horizontal

No.	Frequency (MHz)	Reading (dBuV)	Correct (dB/m)	Result (dBuV/m)	Limit (dBuV/m)	Margin (dB)	Remark
1	1666.000	51.93	-12.16	39.77	82.25	-42.48	peak
2	4177.000	47.97	-3.66	44.31	82.25	-37.94	peak
3	4996.000	47.29	-0.17	47.12	82.25	-35.13	peak
4	6004.000	45.01	1.87	46.88	82.25	-35.37	peak
5	7498.000	41.77	5.69	47.46	82.25	-34.79	peak
6	9199.000	37.06	9.82	46.88	82.25	-35.37	peak

QPSK-20 MHz-Low Channel- Vertical(worst case)

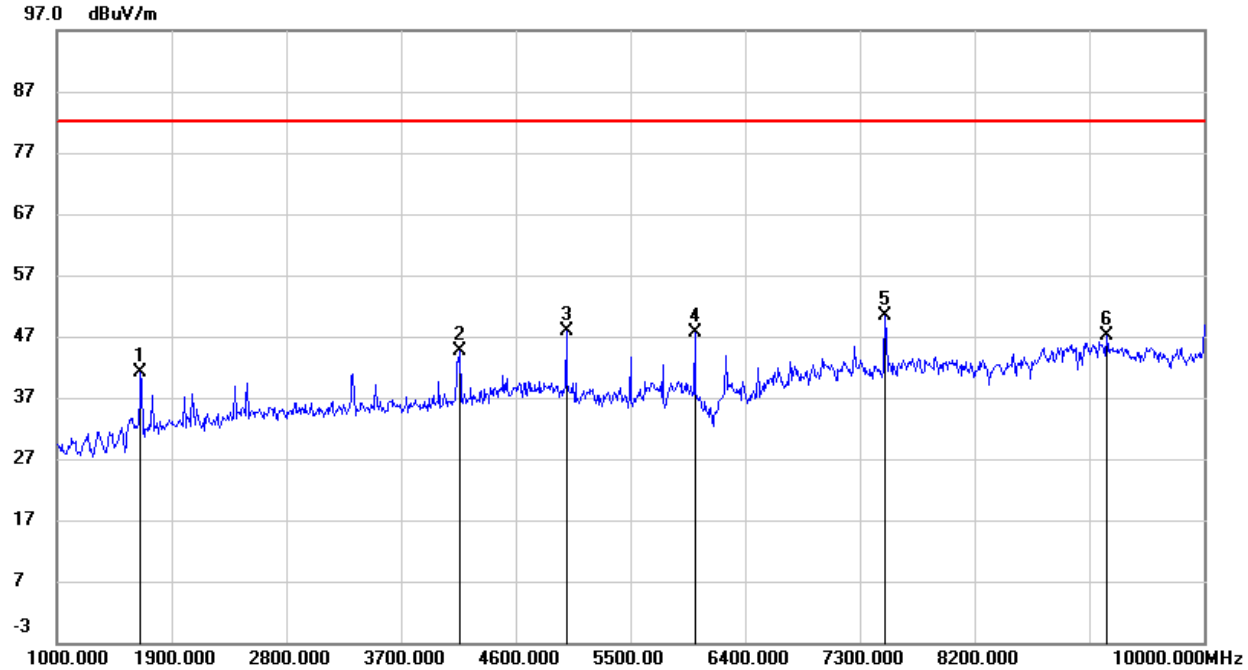

No.	Frequency (MHz)	Reading (dBuV)	Correct (dB/m)	Result (dBuV/m)	Limit (dBuV/m)	Margin (dB)	Remark
1	1657.000	53.22	-12.19	41.03	82.25	-41.22	peak
2	4159.000	48.27	-3.74	44.53	82.25	-37.72	peak
3	4996.000	47.95	-0.17	47.78	82.25	-34.47	peak
4	6004.000	45.83	1.87	47.70	82.25	-34.55	peak
5	7498.000	44.71	5.69	50.40	82.25	-31.85	peak
6	9235.000	37.37	9.84	47.21	82.25	-35.04	peak



QPSK-10 MHz-Mid Channel- Horizontal

No.	Frequency (MHz)	Reading (dBuV)	Correct (dB/m)	Result (dBuV/m)	Limit (dBuV/m)	Margin (dB)	Remark
1	4177.000	46.23	-3.66	42.57	82.25	-39.68	peak
2	4996.000	47.14	-0.17	46.97	82.25	-35.28	peak
3	5500.000	47.01	0.42	47.43	82.25	-34.82	peak
4	6004.000	44.99	1.87	46.86	82.25	-35.39	peak
5	7498.000	42.77	5.69	48.46	82.25	-33.79	peak
6	9181.000	36.50	9.81	46.31	82.25	-35.94	peak

QPSK-10 MHz-Mid Channel- Vertical

No.	Frequency (MHz)	Reading (dBuV)	Correct (dB/m)	Result (dBuV/m)	Limit (dBuV/m)	Margin (dB)	Remark
1	1666.000	51.93	-12.16	39.77	82.25	-42.48	peak
2	4177.000	47.97	-3.66	44.31	82.25	-37.94	peak
3	4996.000	47.29	-0.17	47.12	82.25	-35.13	peak
4	6004.000	45.01	1.87	46.88	82.25	-35.37	peak
5	7498.000	41.77	5.69	47.46	82.25	-34.79	peak
6	9199.000	37.06	9.82	46.88	82.25	-35.37	peak

QPSK-10 MHz-High Channel- Horizontal

No.	Frequency (MHz)	Reading (dBuV)	Correct (dB/m)	Result (dBuV/m)	Limit (dBuV/m)	Margin (dB)	Remark
1	4231.000	47.37	-3.40	43.97	82.25	-38.28	peak
2	4996.000	47.86	-0.17	47.69	82.25	-34.56	peak
3	5500.000	46.64	0.42	47.06	82.25	-35.19	peak
4	6004.000	45.77	1.87	47.64	82.25	-34.61	peak
5	7498.000	42.03	5.69	47.72	82.25	-34.53	peak
6	8965.000	36.77	9.49	46.26	82.25	-35.99	peak

QPSK-10 MHz-High Channel- Vertical

No.	Frequency (MHz)	Reading (dBuV)	Correct (dB/m)	Result (dBuV/m)	Limit (dBuV/m)	Margin (dB)	Remark
1	3385.000	49.95	-6.11	43.84	82.25	-38.41	peak
2	4222.000	48.10	-3.44	44.66	82.25	-37.59	peak
3	4996.000	48.08	-0.17	47.91	82.25	-34.34	peak
4	6004.000	44.03	1.87	45.90	82.25	-36.35	peak
5	7498.000	42.05	5.69	47.74	82.25	-34.51	peak
6	9199.000	36.25	9.82	46.07	82.25	-36.18	peak

Note: Limit= -13dBm+95.2=82.25 dBuV/m

**LTE Band 7**

QPSK-20 MHz-Low Channel- Horizontal

No.	Frequency (MHz)	Reading (dBuV)	Correct (dB/m)	Result (dBuV/m)	Limit (dBuV/m)	Margin (dB)	Remark
1	4995.000	46.98	0.43	47.41	70.25	-22.84	peak
2	6000.000	44.52	2.25	46.77	70.25	-23.48	peak
3	7500.000	41.72	6.33	48.05	70.25	-22.20	peak
4	11715.000	35.65	17.19	52.84	70.25	-17.41	peak
5	13680.000	32.87	21.29	54.16	70.25	-16.09	peak
6	17940.000	29.44	25.34	54.78	70.25	-15.47	peak

QPSK-20 MHz-Low Channel- Vertical

No.	Frequency (MHz)	Reading (dBuV)	Correct (dB/m)	Result (dBuV/m)	Limit (dBuV/m)	Margin (dB)	Remark
1	4995.000	47.11	0.43	47.54	70.25	-22.71	peak
2	6000.000	44.46	2.25	46.71	70.25	-23.54	peak
3	7500.000	42.30	6.33	48.63	70.25	-21.62	peak
4	10035.000	42.08	12.08	54.16	70.25	-16.09	peak
5	14070.000	32.94	21.67	54.61	70.25	-15.64	peak
6	18000.000	28.36	25.69	54.05	70.25	-16.20	peak

QPSK-20 MHz-Mid Channel- Horizontal

No.	Frequency (MHz)	Reading (dBuV)	Correct (dB/m)	Result (dBuV/m)	Limit (dBuV/m)	Margin (dB)	Remark
1	6000.000	44.91	2.25	47.16	70.25	-23.09	peak
2	6750.000	43.09	5.45	48.54	70.25	-21.71	peak
3	10140.000	37.76	12.29	50.05	70.25	-20.20	peak
4	11715.000	35.54	17.19	52.73	70.25	-17.52	peak
5	13785.000	32.91	21.51	54.42	70.25	-15.83	peak
6	17970.000	28.75	25.51	54.26	70.25	-15.99	peak

QPSK-20 MHz-Mid Channel- Vertical

No.	Frequency (MHz)	Reading (dBuV)	Correct (dB/m)	Result (dBuV/m)	Limit (dBuV/m)	Margin (dB)	Remark
1	4995.000	46.15	0.43	46.58	70.25	-23.67	peak
2	7500.000	42.01	6.33	48.34	70.25	-21.91	peak
3	10140.000	44.95	12.29	57.24	70.25	-13.01	peak
4	11790.000	35.32	17.38	52.70	70.25	-17.55	peak
5	13635.000	33.42	21.19	54.61	70.25	-15.64	peak
6	17700.000	29.75	23.91	53.66	70.25	-16.59	peak



QPSK-20 MHz-High Channel- Horizontal

No.	Frequency (MHz)	Reading (dBuV)	Correct (dB/m)	Result (dBuV/m)	Limit (dBuV/m)	Margin (dB)	Remark
1	5115.000	45.68	0.54	46.22	70.25	-24.03	peak
2	7500.000	41.05	6.33	47.38	70.25	-22.87	peak
3	10245.000	41.90	12.48	54.38	70.25	-15.87	peak
4	11880.000	35.51	17.63	53.14	70.25	-17.11	peak
5	13620.000	33.23	21.15	54.38	70.25	-15.87	peak
6	18000.000	28.57	25.69	54.26	70.25	-15.99	peak

QPSK-20 MHz-High Channel- Vertical(worst case)

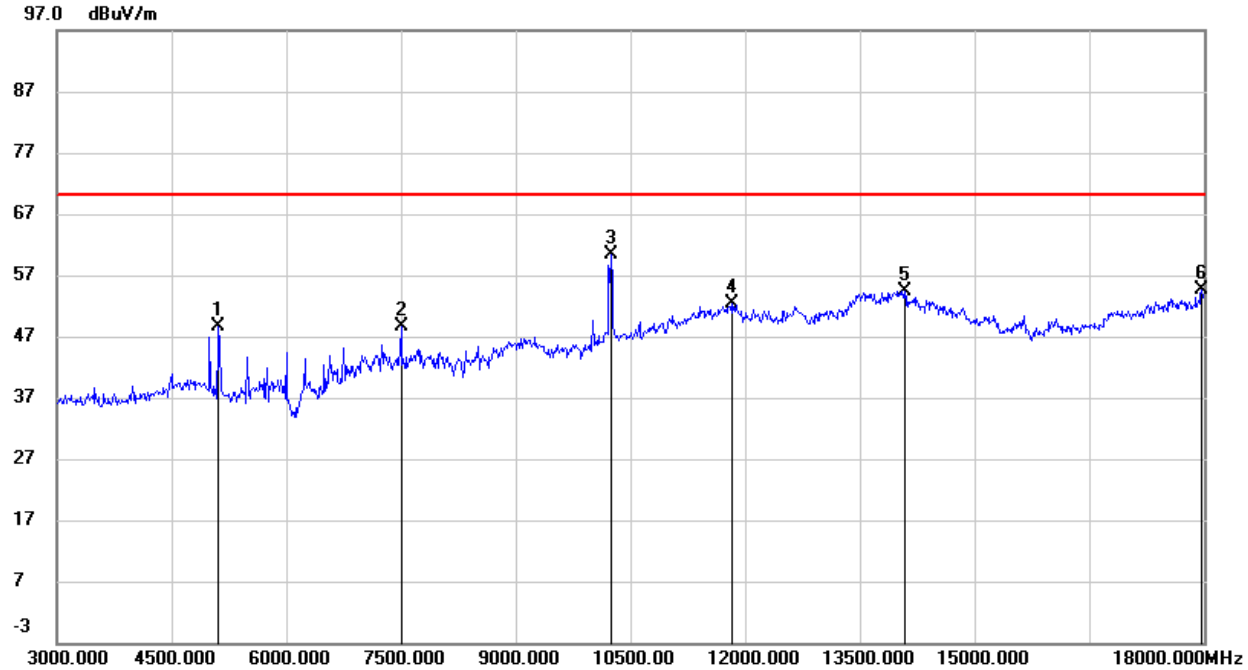

No.	Frequency (MHz)	Reading (dBuV)	Correct (dB/m)	Result (dBuV/m)	Limit (dBuV/m)	Margin (dB)	Remark
1	5115.000	48.12	0.54	48.66	70.25	-21.59	peak
2	7500.000	42.42	6.33	48.75	70.25	-21.50	peak
3	10245.000	47.90	12.48	60.38	70.25	-9.87	peak
4	11835.000	34.92	17.51	52.43	70.25	-17.82	peak
5	14085.000	32.72	21.61	54.33	70.25	-15.92	peak
6	17970.000	29.21	25.51	54.72	70.25	-15.53	peak

Note: Limit= -25dBm+95.2=70.25 dBuV/m

**LTE Band 25****QPSK-20 MHz-Low Channel- Horizontal**

No.	Frequency (MHz)	Reading (dBuV)	Correct (dB/m)	Result (dBuV/m)	Limit (dBuV/m)	Margin (dB)	Remark
1	4995.000	44.35	0.43	44.78	82.25	-37.47	peak
2	6000.000	43.73	2.25	45.98	82.25	-36.27	peak
3	7500.000	42.54	6.33	48.87	82.25	-33.38	peak
4	11880.000	34.44	17.63	52.07	82.25	-30.18	peak
5	13485.000	33.57	20.84	54.41	82.25	-27.84	peak
6	17985.000	28.29	25.60	53.89	82.25	-28.36	peak

QPSK-20 MHz-Low Channel- Vertical

No.	Frequency (MHz)	Reading (dBuV)	Correct (dB/m)	Result (dBuV/m)	Limit (dBuV/m)	Margin (dB)	Remark
1	6000.000	43.73	2.25	45.98	82.25	-36.27	peak
2	7500.000	41.55	6.33	47.88	82.25	-34.37	peak
3	10005.000	38.66	12.02	50.68	82.25	-31.57	peak
4	11880.000	34.74	17.63	52.37	82.25	-29.88	peak
5	13995.000	33.01	21.95	54.96	82.25	-27.29	peak
6	17970.000	28.87	25.51	54.38	82.25	-27.87	peak

QPSK-20 MHz-Mid Channel- Horizontal

No.	Frequency (MHz)	Reading (dBuV)	Correct (dB/m)	Result (dBuV/m)	Limit (dBuV/m)	Margin (dB)	Remark
1	6000.000	44.31	2.25	46.56	82.25	-35.69	peak
2	6750.000	41.34	5.45	46.79	82.25	-35.46	peak
3	7530.000	43.02	6.33	49.35	82.25	-32.90	peak
4	11685.000	35.13	17.10	52.23	82.25	-30.02	peak
5	13500.000	33.52	20.90	54.42	82.25	-27.83	peak
6	17865.000	29.17	24.89	54.06	82.25	-28.19	peak

QPSK-20 MHz-Mid Channel- Vertical

No.	Frequency (MHz)	Reading (dBuV)	Correct (dB/m)	Result (dBuV/m)	Limit (dBuV/m)	Margin (dB)	Remark
1	4995.000	46.57	0.43	47.00	82.25	-35.25	peak
2	5625.000	45.95	1.20	47.15	82.25	-35.10	peak
3	7530.000	44.24	6.33	50.57	82.25	-31.68	peak
4	11745.000	34.46	17.27	51.73	82.25	-30.52	peak
5	13665.000	33.79	21.25	55.04	82.25	-27.21	peak
6	17955.000	28.88	25.42	54.30	82.25	-27.95	peak

QPSK-20 MHz-High Channel- Vertical

No.	Frequency (MHz)	Reading (dBuV)	Correct (dB/m)	Result (dBuV/m)	Limit (dBuV/m)	Margin (dB)	Remark
1	5490.000	45.42	0.84	46.26	82.25	-35.99	peak
2	7500.000	41.90	6.33	48.23	82.25	-34.02	peak
3	10005.000	37.42	12.02	49.44	82.25	-32.81	peak
4	11805.000	34.98	17.43	52.41	82.25	-29.84	peak
5	13560.000	33.87	21.04	54.91	82.25	-27.34	peak
6	18000.000	28.32	25.69	54.01	82.25	-28.24	peak



QPSK-20 MHz-High Channel- Horizontal(worst case)

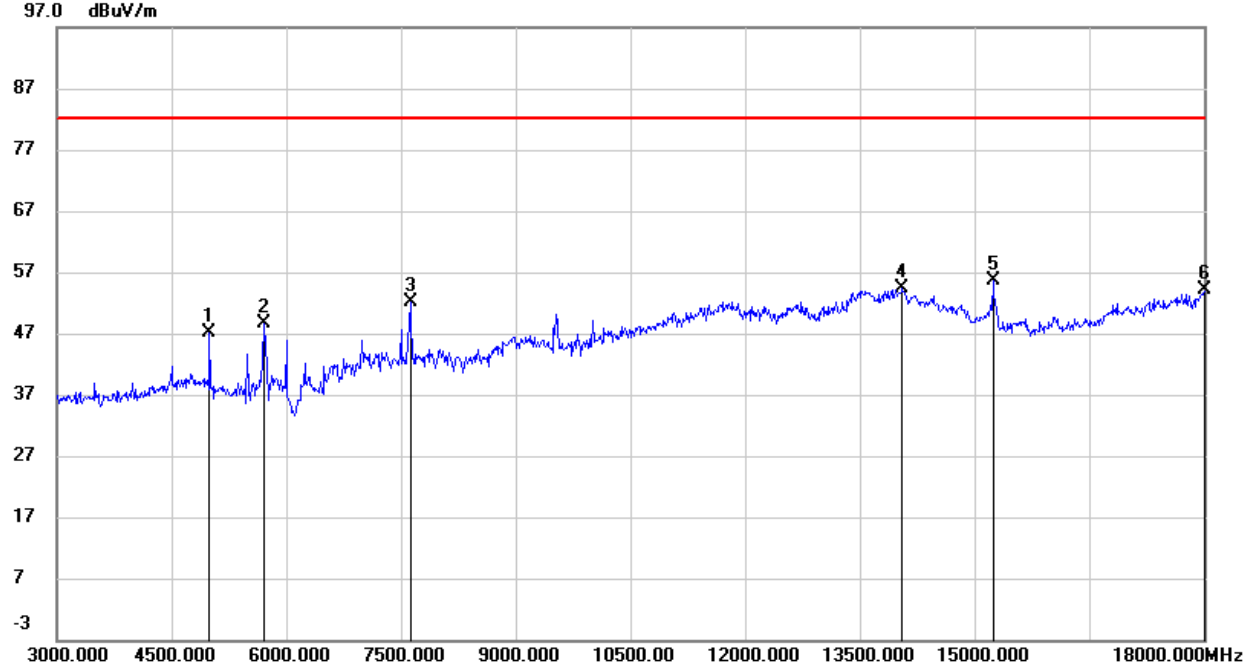

No.	Frequency (MHz)	Reading (dBuV)	Correct (dB/m)	Result (dBuV/m)	Limit (dBuV/m)	Margin (dB)	Remark
1	4995.000	46.59	0.43	47.02	82.25	-35.23	peak
2	5715.000	47.24	1.46	48.70	82.25	-33.55	peak
3	7620.000	45.72	6.33	52.05	82.25	-30.20	peak
4	14055.000	32.63	21.73	54.36	82.25	-27.89	peak
5	15240.000	37.94	17.65	55.59	82.25	-26.66	peak
6	18000.000	28.35	25.69	54.04	82.25	-28.21	peak

Note: Limit= -13dBm+95.2=82.25 dBuV/m



LTE Band 26

QPSK-10 MHz-Mid Channel- Horizontal(worst case)

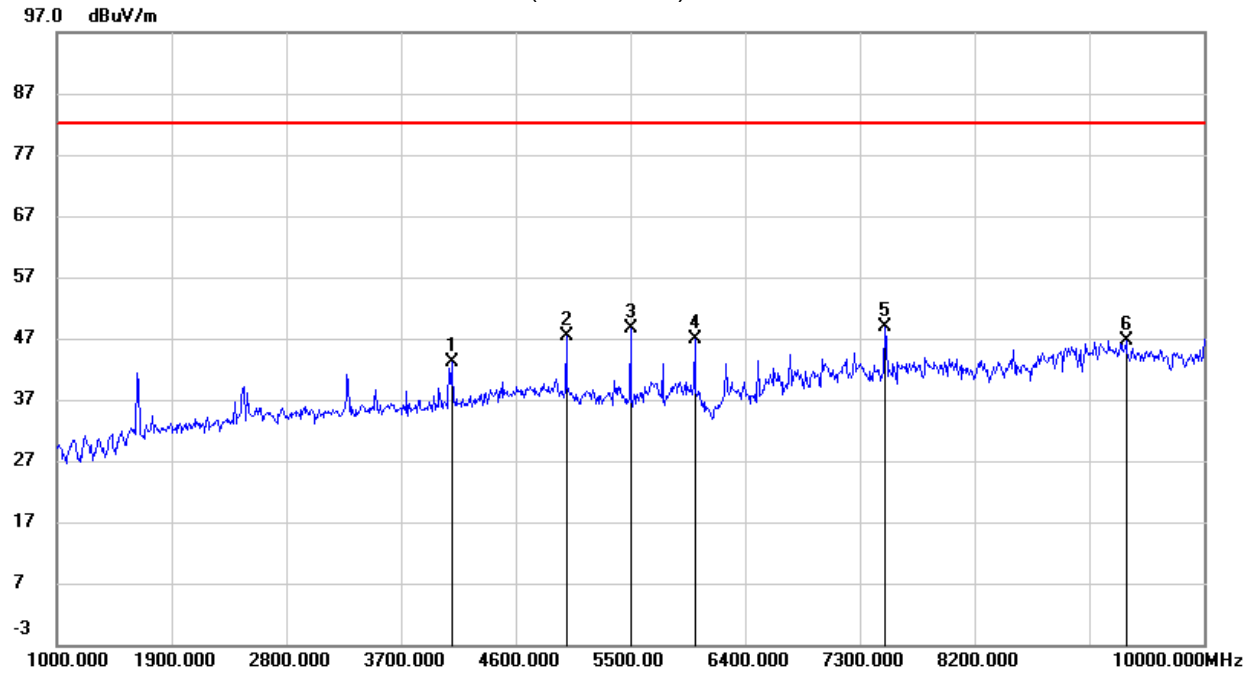

No.	Frequency (MHz)	Reading (dBuV)	Correct (dB/m)	Result (dBuV/m)	Limit (dBuV/m)	Margin (dB)	Remark
1	4096.000	47.06	-4.03	43.03	82.25	-39.22	peak
2	4996.000	47.51	-0.17	47.34	82.25	-34.91	peak
3	5500.000	48.21	0.42	48.63	82.25	-33.62	peak
4	6004.000	45.07	1.87	46.94	82.25	-35.31	peak
5	7498.000	43.21	5.69	48.90	82.25	-33.35	peak
6	9388.000	36.68	9.90	46.58	82.25	-35.67	peak

QPSK-10 MHz-Mid Channel- Vertical

No.	Frequency (MHz)	Reading (dBuV)	Correct (dB/m)	Result (dBuV/m)	Limit (dBuV/m)	Margin (dB)	Remark
1	1630.000	53.41	-12.28	41.13	82.25	-41.12	peak
2	4105.000	47.82	-3.99	43.83	82.25	-38.42	peak
3	4996.000	47.44	-0.17	47.27	82.25	-34.98	peak
4	6004.000	43.78	1.87	45.65	82.25	-36.60	peak
5	7498.000	41.89	5.69	47.58	82.25	-34.67	peak
6	9262.000	36.84	9.84	46.68	82.25	-35.57	peak



QPSK-15 MHz-Low Channel- Horizontal

No.	Frequency (MHz)	Reading (dBuV)	Correct (dB/m)	Result (dBuV/m)	Limit (dBuV/m)	Margin (dB)	Remark
1	2494.000	48.72	-8.52	40.20	82.25	-42.05	peak
2	4996.000	46.86	-0.17	46.69	82.25	-35.56	peak
3	5500.000	47.07	0.42	47.49	82.25	-34.76	peak
4	6004.000	44.98	1.87	46.85	82.25	-35.40	peak
5	7498.000	42.74	5.69	48.43	82.25	-33.82	peak
6	8938.000	36.35	9.31	45.66	82.25	-36.59	peak

QPSK-15 MHz-Low Channel- Vertical(worst case)

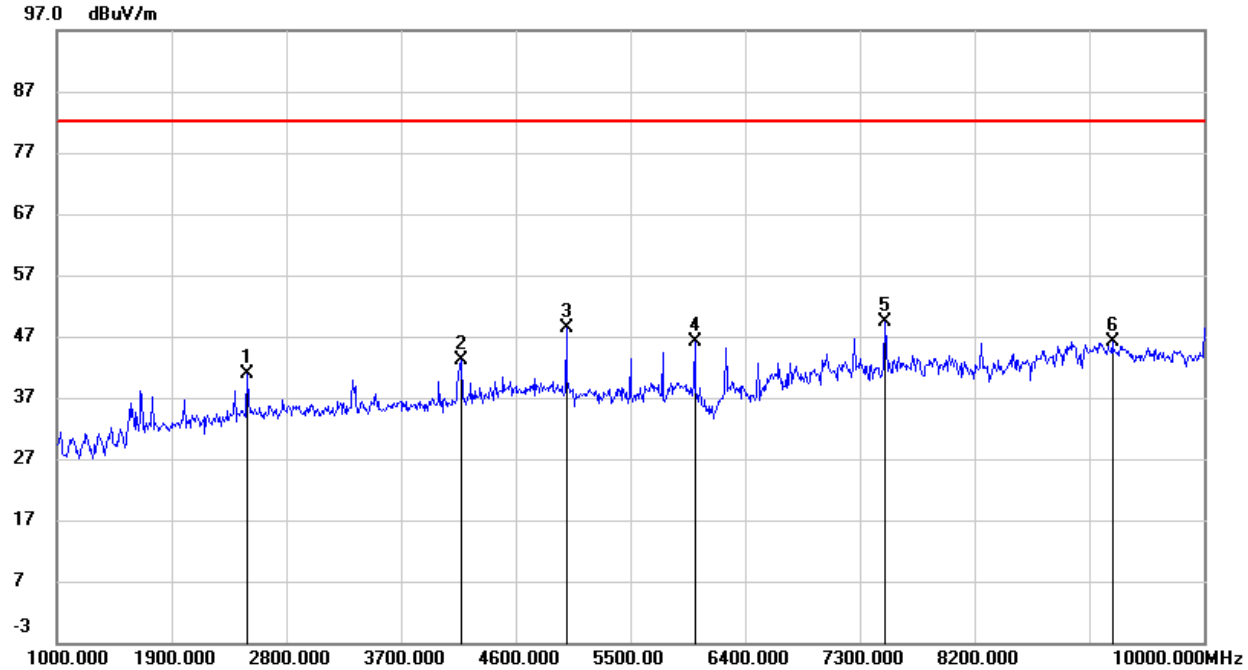

No.	Frequency (MHz)	Reading (dBuV)	Correct (dB/m)	Result (dBuV/m)	Limit (dBuV/m)	Margin (dB)	Remark
1	2494.000	49.32	-8.52	40.80	82.25	-41.45	peak
2	4177.000	46.67	-3.66	43.01	82.25	-39.24	peak
3	4996.000	48.63	-0.17	48.46	82.25	-33.79	peak
4	6004.000	44.29	1.87	46.16	82.25	-36.09	peak
5	7498.000	43.70	5.69	49.39	82.25	-32.86	peak
6	9280.000	36.26	9.85	46.11	82.25	-36.14	peak



QPSK-15 MHz-Mid Channel- Horizontal

No.	Frequency (MHz)	Reading (dBuV)	Correct (dB/m)	Result (dBuV/m)	Limit (dBuV/m)	Margin (dB)	Remark
1	4168.000	47.14	-3.69	43.45	82.25	-38.80	peak
2	4996.000	47.66	-0.17	47.49	82.25	-34.76	peak
3	5500.000	47.20	0.42	47.62	82.25	-34.63	peak
4	6004.000	44.99	1.87	46.86	82.25	-35.39	peak
5	7498.000	42.41	5.69	48.10	82.25	-34.15	peak
6	9181.000	36.47	9.81	46.28	82.25	-35.97	peak

QPSK-15 MHz- Mid Channel- Vertical

No.	Frequency (MHz)	Reading (dBuV)	Correct (dB/m)	Result (dBuV/m)	Limit (dBuV/m)	Margin (dB)	Remark
1	2494.000	47.85	-8.52	39.33	82.25	-42.92	peak
2	4186.000	46.26	-3.61	42.65	82.25	-39.60	peak
3	4996.000	48.17	-0.17	48.00	82.25	-34.25	peak
4	6004.000	43.36	1.87	45.23	82.25	-37.02	peak
5	7498.000	42.25	5.69	47.94	82.25	-34.31	peak
6	9199.000	36.80	9.82	46.62	82.25	-35.63	peak

QPSK-15 MHz-High Channel- Horizontal

No.	Frequency (MHz)	Reading (dBuV)	Correct (dB/m)	Result (dBuV/m)	Limit (dBuV/m)	Margin (dB)	Remark
1	2494.000	47.15	-8.52	38.63	82.25	-43.62	peak
2	4996.000	47.59	-0.17	47.42	82.25	-34.83	peak
3	5500.000	47.40	0.42	47.82	82.25	-34.43	peak
4	6004.000	44.20	1.87	46.07	82.25	-36.18	peak
5	7498.000	41.84	5.69	47.53	82.25	-34.72	peak
6	9190.000	36.14	9.81	45.95	82.25	-36.30	peak

QPSK-15 MHz-High Channel- Vertical

No.	Frequency (MHz)	Reading (dBuV)	Correct (dB/m)	Result (dBuV/m)	Limit (dBuV/m)	Margin (dB)	Remark
1	2494.000	50.18	-8.52	41.66	82.25	-40.59	peak
2	4213.000	45.36	-3.48	41.88	82.25	-40.37	peak
3	4996.000	47.77	-0.17	47.60	82.25	-34.65	peak
4	6004.000	43.79	1.87	45.66	82.25	-36.59	peak
5	7498.000	42.29	5.69	47.98	82.25	-34.27	peak
6	9199.000	37.10	9.82	46.92	82.25	-35.33	peak

Note: Limit= -13dBm+95.2=82.25 dBuV/m

**LTE Band 38**

QPSK-20 MHz-Low Channel- Horizontal

No.	Frequency (MHz)	Reading (dBuV)	Correct (dB/m)	Result (dBuV/m)	Limit (dBuV/m)	Margin (dB)	Remark
1	4995.000	47.01	0.43	47.44	70.25	-22.81	peak
2	6750.000	42.76	5.45	48.21	70.25	-22.04	peak
3	10320.000	43.01	12.64	55.65	70.25	-14.60	peak
4	11910.000	34.42	17.72	52.14	70.25	-18.11	peak
5	13905.000	32.71	21.76	54.47	70.25	-15.78	peak
6	17970.000	28.82	25.51	54.33	70.25	-15.92	peak

QPSK-20 MHz-Low Channel- Vertical

No.	Frequency (MHz)	Reading (dBuV)	Correct (dB/m)	Result (dBuV/m)	Limit (dBuV/m)	Margin (dB)	Remark
1	4995.000	47.21	0.43	47.64	70.25	-22.61	peak
2	6000.000	44.50	2.25	46.75	70.25	-23.50	peak
3	7245.000	42.55	6.51	49.06	70.25	-21.19	peak
4	10320.000	50.97	12.64	63.61	70.25	-6.64	peak
5	14460.000	35.01	20.08	55.09	70.25	-15.16	peak
6	18000.000	28.40	25.69	54.09	70.25	-16.16	peak

QPSK-20 MHz-Mid Channel- Horizontal

No.	Frequency (MHz)	Reading (dBuV)	Correct (dB/m)	Result (dBuV/m)	Limit (dBuV/m)	Margin (dB)	Remark
1	4995.000	45.97	0.43	46.40	70.25	-23.85	peak
2	6750.000	43.17	5.45	48.62	70.25	-21.63	peak
3	10380.000	44.94	12.75	57.69	70.25	-12.56	peak
4	11790.000	35.31	17.38	52.69	70.25	-17.56	peak
5	14010.000	32.52	21.93	54.45	70.25	-15.80	peak
6	17940.000	28.89	25.34	54.23	70.25	-16.02	peak

QPSK-20 MHz-Mid Channel- Vertical

No.	Frequency (MHz)	Reading (dBuV)	Correct (dB/m)	Result (dBuV/m)	Limit (dBuV/m)	Margin (dB)	Remark
1	4995.000	47.06	0.43	47.49	70.25	-22.76	peak
2	7500.000	41.12	6.33	47.45	70.25	-22.80	peak
3	10380.000	49.29	12.75	62.04	70.25	-8.21	peak
4	11760.000	35.03	17.31	52.34	70.25	-17.91	peak
5	13980.000	32.93	21.92	54.85	70.25	-15.40	peak
6	17985.000	28.12	25.60	53.72	70.25	-16.53	peak



QPSK-20 MHz-High Channel- Horizontal

No.	Frequency (MHz)	Reading (dBuV)	Correct (dB/m)	Result (dBuV/m)	Limit (dBuV/m)	Margin (dB)	Remark
1	6750.000	42.79	5.45	48.24	70.25	-22.01	peak
2	7500.000	41.97	6.33	48.30	70.25	-21.95	peak
3	10440.000	44.65	12.87	57.52	70.25	-12.73	peak
4	11880.000	33.96	17.63	51.59	70.25	-18.66	peak
5	14070.000	32.91	21.67	54.58	70.25	-15.67	peak
6	17595.000	30.38	23.29	53.67	70.25	-16.58	peak

QPSK-20 MHz-High Channel- Vertical(worst case)

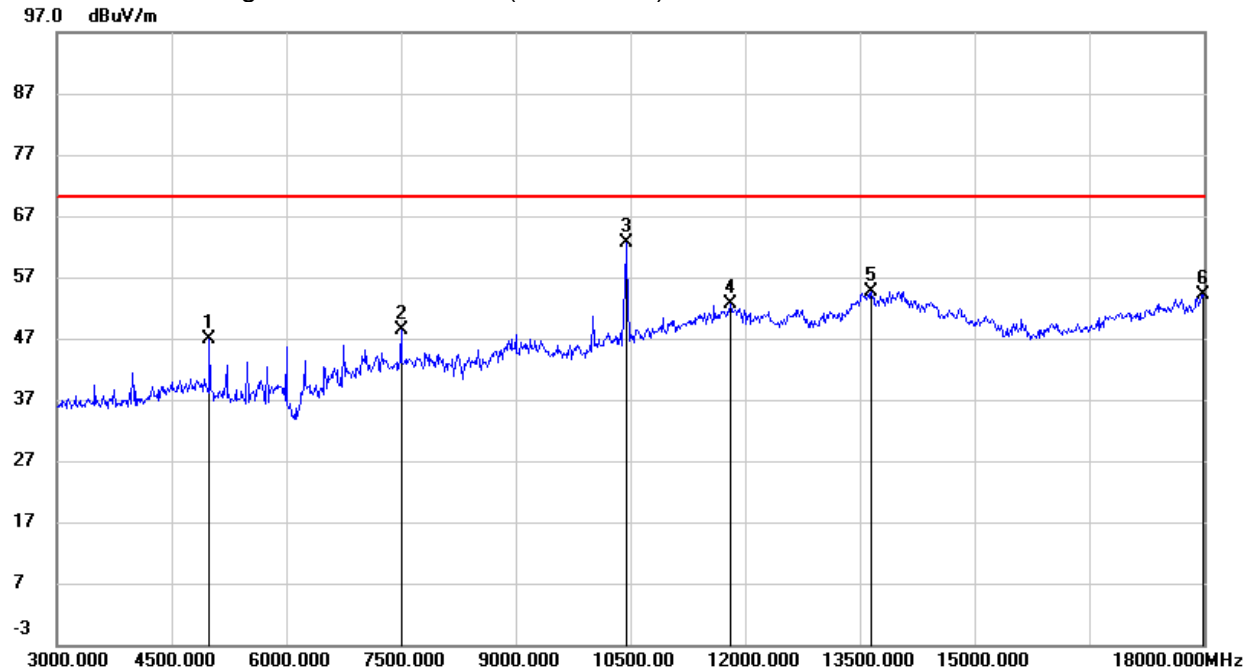

No.	Frequency (MHz)	Reading (dBuV)	Correct (dB/m)	Result (dBuV/m)	Limit (dBuV/m)	Margin (dB)	Remark
1	4995.000	46.37	0.43	46.80	70.25	-23.45	peak
2	7500.000	42.12	6.33	48.45	70.25	-21.80	peak
3	10440.000	49.71	12.87	62.58	70.25	-7.67	peak
4	11805.000	35.11	17.43	52.54	70.25	-17.71	peak
5	13650.000	33.46	21.21	54.67	70.25	-15.58	peak
6	17985.000	28.50	25.60	54.10	70.25	-16.15	peak

Note: Limit= -25dBm+95.2=70.25 dBuV/m

**LTE Band 41**

QPSK-20 MHz-Low Channel- Horizontal

No.	Frequency (MHz)	Reading (dBuV)	Correct (dB/m)	Result (dBuV/m)	Limit (dBuV/m)	Margin (dB)	Remark
1	6000.000	44.49	2.25	46.74	70.25	-23.51	peak
2	6750.000	42.99	5.45	48.44	70.25	-21.81	peak
3	7500.000	43.28	6.33	49.61	70.25	-20.64	peak
4	10005.000	37.60	12.02	49.62	70.25	-20.63	peak
5	12510.000	34.86	17.62	52.48	70.25	-17.77	peak
6	13860.000	33.55	21.67	55.22	70.25	-15.03	peak

QPSK-20 MHz-Low Channel- Vertical

No.	Frequency (MHz)	Reading (dBuV)	Correct (dB/m)	Result (dBuV/m)	Limit (dBuV/m)	Margin (dB)	Remark
1	6000.000	44.29	2.25	46.54	70.25	-23.71	peak
2	7500.000	43.56	6.33	49.89	70.25	-20.36	peak
3	10020.000	46.07	12.06	58.13	70.25	-12.12	peak
4	11700.000	34.90	17.14	52.04	70.25	-18.21	peak
5	13980.000	32.43	21.92	54.35	70.25	-15.90	peak
6	17955.000	29.19	25.42	54.61	70.25	-15.64	peak

QPSK-20 MHz-Mid Channel- Horizontal

No.	Frequency (MHz)	Reading (dBuV)	Correct (dB/m)	Result (dBuV/m)	Limit (dBuV/m)	Margin (dB)	Remark
1	4995.000	44.99	0.43	45.42	70.25	-24.83	peak
2	7500.000	43.00	6.33	49.33	70.25	-20.92	peak
3	10365.000	42.88	12.72	55.60	70.25	-14.65	peak
4	11835.000	34.86	17.51	52.37	70.25	-17.88	peak
5	13575.000	33.29	21.06	54.35	70.25	-15.90	peak
6	17985.000	29.10	25.60	54.70	70.25	-15.55	peak

QPSK-20 MHz-Mid Channel- Vertical

No.	Frequency (MHz)	Reading (dBuV)	Correct (dB/m)	Result (dBuV/m)	Limit (dBuV/m)	Margin (dB)	Remark
1	6000.000	44.84	2.25	47.09	70.25	-23.16	peak
2	7500.000	41.93	6.33	48.26	70.25	-21.99	peak
3	10365.000	50.40	12.72	63.12	70.25	-7.13	peak
4	12675.000	33.93	17.99	51.92	70.25	-18.33	peak
5	14025.000	32.92	21.86	54.78	70.25	-15.47	peak
6	17610.000	29.94	23.38	53.32	70.25	-16.93	peak



QPSK-20 MHz-High Channel- Horizontal

No.	Frequency (MHz)	Reading (dBuV)	Correct (dB/m)	Result (dBuV/m)	Limit (dBuV/m)	Margin (dB)	Remark
1	4995.000	44.46	0.43	44.89	70.25	-25.36	peak
2	6750.000	40.89	5.45	46.34	70.25	-23.91	peak
3	7500.000	42.42	6.33	48.75	70.25	-21.50	peak
4	10725.000	47.55	13.79	61.34	70.25	-8.91	peak
5	13995.000	33.27	21.95	55.22	70.25	-15.03	peak
6	17610.000	30.50	23.38	53.88	70.25	-16.37	peak

QPSK-20 MHz-High Channel- Vertical(worst case)

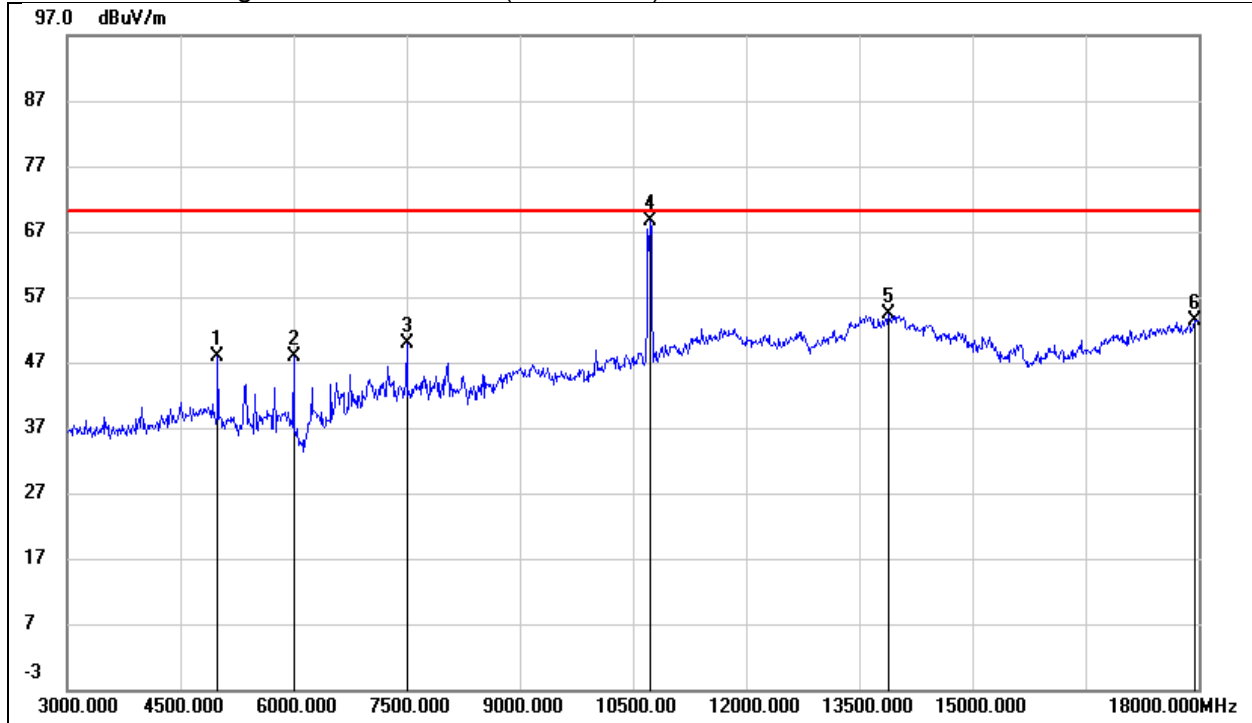

No.	Frequency (MHz)	Reading (dBuV)	Correct (dB/m)	Result (dBuV/m)	Limit (dBuV/m)	Margin (dB)	Remark
1	4995.000	47.54	0.43	47.97	70.25	-22.28	peak
2	6000.000	45.52	2.25	47.77	70.25	-22.48	peak
3	7500.000	43.51	6.33	49.84	70.25	-20.41	peak
4	10725.000	54.95	13.79	68.74	70.25	-1.51	peak
5	13890.000	32.67	21.72	54.39	70.25	-15.86	peak
6	17955.000	28.01	25.42	53.43	70.25	-16.82	peak

Note: Limit= -25dBm+95.25=70.25 dBuV/m

END OF REPORT