



**CFR 47 FCC PART 22 H
CFR 47 FCC PART 24 E
CFR 47 FCC PART 27**

TEST REPORT

For

P40 Agricultural Drone

MODEL NUMBER: 3WWDZ-20BH

FCC ID: 2A46G-3WWDZ-20BH

REPORT NUMBER: 4790254511-5

ISSUE DATE: March 31, 2022

Prepared for

Guangzhou Xaircraft Technology CO.,LTD

**Block C, 115 Gaopu Rd, Tianhe Dist, Guangzhou, Guang-dong,
China**

Prepared by

UL Verification Services (Guangzhou) Co., Ltd, Song Shan Lake Branch

Building 10, Innovation Technology Park, No. 1, Li Bin Road, Song Shan Lake Hi-Tech Development Zone Dongguan, 523808, People's Republic of China

Tel: +86 769 22038881

Fax: +86 769 33244054

Website: www.ul.com



Revision History

<u>Rev.</u>	<u>Issue Date</u>	<u>Revisions</u>	<u>Revised By</u>
V0	03/31/2022	Initial Issue	

Note:

- 1.This test report is only published to and used by the applicant, and it is not for evidence purpose in China.
2. The measurement result for the sample received is <Pass> according to < CFR 47 FCC PART 22 H >< CFR 47 FCC PART 24 E> > < CFR 47 FCC PART 27 > < when <Accuracy Method> decision rule is applied.



TABLE OF CONTENTS

1. ATTESTATION OF TEST RESULTS	4
2. TEST METHODOLOGY	5
3. FACILITIES AND ACCREDITATION	5
4. CALIBRATION AND UNCERTAINTY	6
4.1. <i>MEASURING INSTRUMENT CALIBRATION</i>	<i>6</i>
4.2. <i>MEASUREMENT UNCERTAINTY.....</i>	<i>6</i>
5. EQUIPMENT UNDER TEST	7
5.1. <i>DESCRIPTION OF EUT</i>	<i>7</i>
5.2. <i>TEST CHANNEL CONFIGURATION.....</i>	<i>7</i>
5.3. <i>MAXIMUM AVERAGE OUTPUT POWER</i>	<i>8</i>
5.4. <i>WORST-CASE CONFIGURATION AND MODE.....</i>	<i>9</i>
5.5. <i>DESCRIPTION OF AVAILABLE ANTENNAS</i>	<i>10</i>
5.6. <i>DESCRIPTION OF TEST SETUP.....</i>	<i>11</i>
6. MEASURING INSTRUMENT AND SOFTWARE USED	12
7. ANTENNA TERMINAL TEST RESULTS.....	13
7.1. <i>EFFECTIVE (ISOTROPIC) RADIATED POWER OF TRANSMITTER</i>	<i>13</i>
7.2. <i>PEAK TO AVERAGE RADIO</i>	<i>18</i>
7.3. <i>OCCUPIED BANDWIDTH</i>	<i>23</i>
7.4. <i>BAND EDGE EMISSIONS.....</i>	<i>29</i>
7.5. <i>SPURIOUS EMISSION AT ANTENNA TERMINAL.....</i>	<i>39</i>
7.6. <i>FREQUENCY STABILITY.....</i>	<i>80</i>
8. RADIATED SPURIOUS EMISSIONS	83



1. ATTESTATION OF TEST RESULTS

Applicant Information

Company Name: Guangzhou Xaircraft Technology CO.,LTD
Address: Block C, 115 Gaopu Rd, Tianhe Dist, Guangzhou, Guang-dong, China

Manufacturer Information

Company Name: Guangzhou Xaircraft Technology CO.,LTD
Address: Block C, 115 Gaopu Rd, Tianhe Dist, Guangzhou, Guang-dong, China

EUT Information

EUT Name: P40 Agricultural Drone
Model: 3WWDZ-20BH
Sample Received Date: February 14, 2022
Sample Status: Normal
Sample ID: 4675027-2
Date of Tested: February 14, 2022 ~ March 30, 2022

APPLICABLE STANDARDS	
STANDARD	TEST RESULTS
CFR 47 FCC PART 22 H	PASS
CFR 47 FCC PART 24 E	PASS
CFR 47 FCC PART 27	PASS

Prepared By:

Kebo Zhang
Project Engineer

Checked By:

Shawn Wen
Laboratory Leader

Approved By:

Stephen Guo
Laboratory Manager



2. TEST METHODOLOGY

The tests documented in this report were performed in accordance with ANSI C63.26-2015, 971168 D01 Power Meas License Digital Systems v03r01, 971168 D02 Misc Rev Approv License Devices v02r01, 412172 D01 v01r01 Determining ERP and EIRP, CFR 47 FCC Part 2, Part 22 H, Part 24 E, Part 27.

3. FACILITIES AND ACCREDITATION

Accreditation Certificate	<p>A2LA (Certificate No.: 4102.01) UL Verification Services (Guangzhou) Co., Ltd. Song Shan Lake Branch. has been assessed and proved to be in compliance with A2LA.</p> <p>FCC (FCC Designation No.: CN1187) UL Verification Services (Guangzhou) Co., Ltd. Song Shan Lake Branch. Has been recognized to perform compliance testing on equipment subject to the Commission's Declaration of Conformity (DoC) and Certification rules</p> <p>ISED (Company No.: 21320) UL Verification Services (Guangzhou) Co., Ltd. Song Shan Lake Branch. has been registered and fully described in a report filed with ISED. The Company Number is 21320 and the test lab Conformity Assessment Body Identifier (CABID) is CN0046.</p> <p>VCCI (Registration No.: G-20019, R-20004, C-20012 and T-20011) UL Verification Services (Guangzhou) Co., Ltd. Song Shan Lake Branch. has been assessed and proved to be in compliance with VCCI, the Membership No. is 3793. Facility Name: Chamber D, the VCCI registration No. is G-20019 and R-20004 Shielding Room B , the VCCI registration No. is C-20012 and T-20011</p>
---------------------------	---

Note 1: All tests measurement facilities use to collect the measurement data are located at Building 10, Innovation Technology Park, Song Shan Lake Hi tech Development Zone, Dongguan, 523808, China

Note 2: The test anechoic chamber in UL Verification Services (Guangzhou) Co., Ltd. Song Shan Lake Branch had been calibrated and compared to the open field sites and the test anechoic chamber is shown to be equivalent to or worst case from the open field site.

Note 3: For below 30 MHz, lab had performed measurements at test anechoic chamber and comparing to measurements obtained on an open field site. And these measurements below 30 MHz had been correlated to measurements performed on an OFS.

4. CALIBRATION AND UNCERTAINTY

4.1. MEASURING INSTRUMENT CALIBRATION

The measuring equipment utilized to perform the tests documented in this report has been calibrated in accordance with the manufacturer's recommendations and is traceable to recognize national standards.

4.2. MEASUREMENT UNCERTAINTY

Where relevant, the following measurement uncertainty levels have been estimated for tests performed on the apparatus:

Test Item	Uncertainty
Conduction emission	3.62 dB
Radiated Emission (Included Fundamental Emission) (9 kHz ~ 30 MHz)	2.2 dB
Radiated Emission (Included Fundamental Emission) (30 MHz ~ 1 GHz)	4.00 dB
Radiated Emission (Included Fundamental Emission) (1 GHz to 40 GHz)	5.78 dB (1 GHz-18 GHz)
	5.23dB (18 GHz-26 GHz)
	5.64 dB (26 GHz-40 GHz)
Bandwidth	1.1 %

Note: This uncertainty represents an expanded uncertainty expressed at approximately the 95 % confidence level using a coverage factor of k=2.



5. EQUIPMENT UNDER TEST

5.1. DESCRIPTION OF EUT

EUT Name	P40 Agricultural Drone
Model Name	3WWDZ-20BH
Rating	Powered by XAG Smart Battery

Item	Equipment	Mfr/Brand	Model/Type No.	Specification	Series No.
1	Smart Battery	XAG	B13960S	Output: DC48.1V/120A	N/A

5.2. TEST CHANNEL CONFIGURATION

Band	Mode	Low	Middle	High
GSM850	GRPS/EGPRS	128	190	251
		824.2 MHz	836.6 MHz	848.8 MHz
GSM1900	GRPS/EGPRS	512	661	810
		1850.2 MHz	1880.0 MHz	1909.8 MHz
WCDMA Band 2	HSDPA/HSUPA	9262	9400	9538
		1852.4 MHz	1880.0 MHz	1907.6 MHz
WCDMA Band 4	HSDPA/HSUPA	1312	1413	1513
		1712.4 MHz	1732.6 MHz	1752.6 MHz



5.3. MAXIMUM AVERAGE OUTPUT POWER

GSM 850						
Part 22H						
ERP Limit(W)	7					
Antenna Gain (dBi)	2					
Mode	Ch	Freq(MHz)	Conducted Average	ERP	99%	Emission
			power (dBm)	(W)	OBW	Designator
					(MHz)	
GRPS(GMSK)	251	848.8	33.82	2.33	0.245	245KGXW
EGPRS(8PSK)	190	836.6	26.44	0.43	0.243	243KG7W

GSM 1900						
Part 24						
EIRP Limit(W)	2					
Antenna Gain (dBi)	2.8					
Mode	Ch	Freq(MHz)	Conducted Average	EIRP	99%	Emission
			power (dBm)	(W)	OBW	Designator
					(MHz)	
GRPS(GMSK)	810	1909.8	28.86	1.47	0.244	244KGXW
EGPRS(8PSK)	810	1909.8	25.18	0.63	0.244	244KG7W

WCDMA Band2						
Part 24						
EIRP Limit(W)	2					
Antenna Gain (dBi)	2.8					
Mode	Ch	Freq(MHz)	Conducted Average	EIRP	99%	Emission
			power (dBm)	(W)	OBW	Designator
					(MHz)	
Rel99	9400	1907.6	22.17	0.31	4.133	4M13F9W
HSDPA	9400	1907.6	21.33	0.26	4.133	4M13F9W
HSUPA	9400	1907.6	21.06	0.24	4.169	4M17F9W

WCDMA Band4						
Part 27						
EIRP Limit(W)		1				
Antenna Gain (dBi)		2.8				
Mode	Ch	Freq(MHz)	Conducted Average	EIRP	99%	Emission
			power (dBm)	(W)	OBW	Designator
					(MHz)	
Rel99	1413	1732.6	22.54	0.34	4.132	4M13F9W
HSDPA	1413	1732.6	21.54	0.27	4.14	4M14F9W
HSUPA	1413	1732.6	21.36	0.26	4.165	4M17F9W

5.4. WORST-CASE CONFIGURATION AND MODE

The radiated spurious emissions measurements were carried out in semi-anechoic chamber with 3-meter test range, and EUT was investigated in three orthogonal orientations X, Y and Z. It was determined that X orientation was the worst-case orientation.

Radiated spurious emissions were investigated below 30 MHz, 30 MHz - 1 GHz and above 1 GHz. There were no emissions found on below 1GHz and above 18 GHz, the emissions between 1 GHz – 18 GHz were tested the highest transmitting power channel and the worse configuration.

For GSM850/1900, GPRS worst results are shown in test report. For WCDMA, HSDPA worst results are shown in test report.



5.5. DESCRIPTION OF AVAILABLE ANTENNAS

Antenna	Band	Antenna Type	MAX Antenna Gain (dBi)
1	GSM850	FPC	2
1	GSM1900	FPC	2.8
1	WCDMA Band 2	FPC	2.8
1	WCDMA Band 4	FPC	2.8

Band	Transmit and Receive Mode	Description
GSM850	<input checked="" type="checkbox"/> 1TX, 1RX	Antenna 1 can be used as transmitting/receiving antenna.
GSM1900	<input checked="" type="checkbox"/> 1TX, 1RX	Antenna 1 can be used as transmitting/receiving antenna.
WCDMA Band 2	<input checked="" type="checkbox"/> 1TX, 1RX	Antenna 1 can be used as transmitting/receiving antenna.
WCDMA Band 4	<input checked="" type="checkbox"/> 1TX, 1RX	Antenna 1 can be used as transmitting/receiving antenna.

Note: The value of the antenna gain was declared by customer.

5.6. DESCRIPTION OF TEST SETUP

Conducted

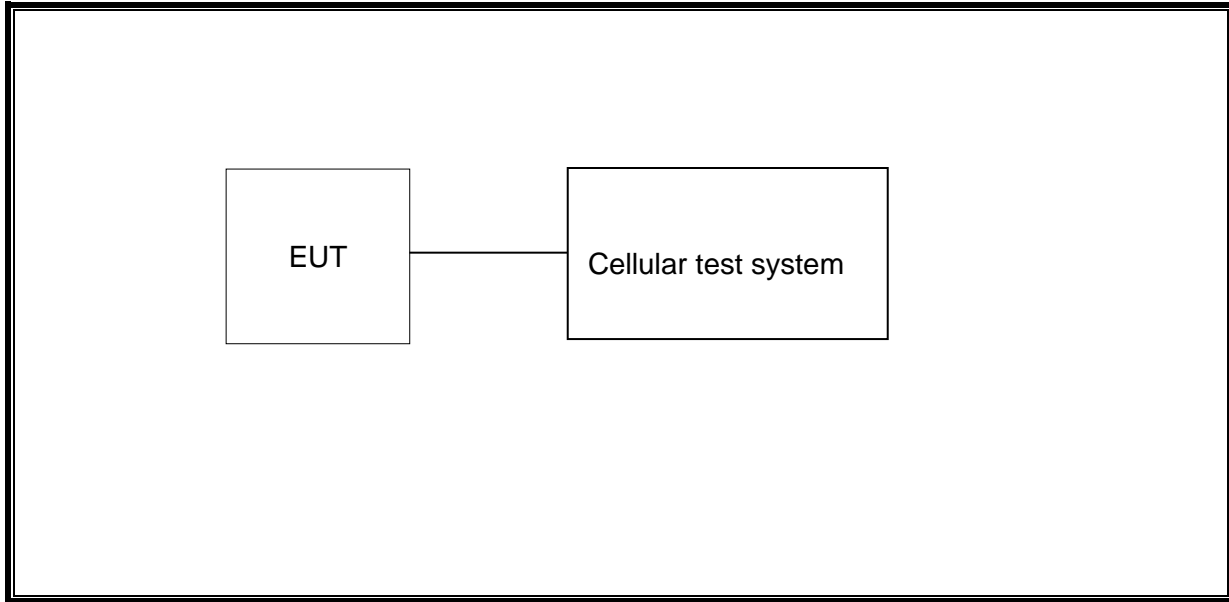

Radiated

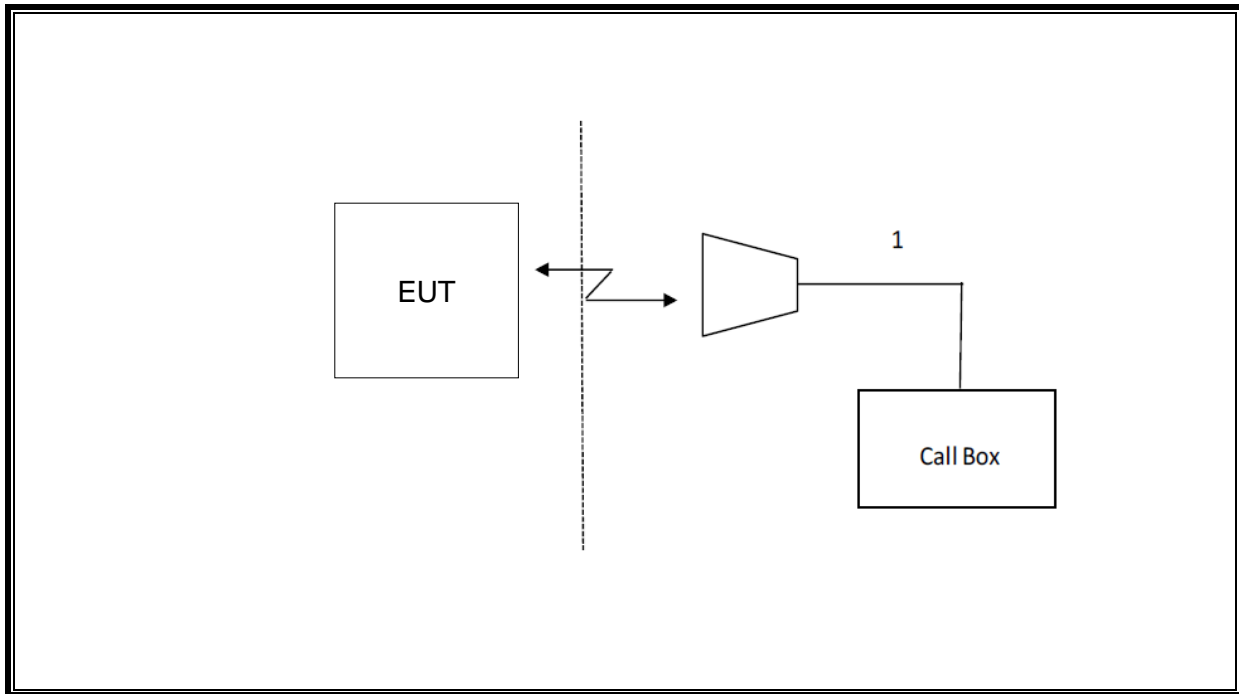



6. MEASURING INSTRUMENT AND SOFTWARE USED

Antenna Terminal Test						
Instrument						
Used	Equipment	Manufacturer	Model No.	Serial No.	Last Cal.	Next Cal.
<input checked="" type="checkbox"/>	Spectrum Analyzer	R&S	FSW40	S421035420	Oct.30, 2021	Oct.29, 2022
<input checked="" type="checkbox"/>	Wideband Radio Communication Tester	R&S	CMW500	155523	Oct.30, 2021	Oct.29, 2022
<input checked="" type="checkbox"/>	DC Power Supply	Array	3662A	A1512015	Oct.30, 2021	Oct.29, 2022
Software						
Used	Description	Manufacturer	Name	Version		
<input checked="" type="checkbox"/>	Tonsend Cellular Test System	Tonsend	JS1120 RF Auto Test System	2.6.9.0826		
Radiated Test						
Instrument						
Used	Equipment	Manufacturer	Model No.	Serial No.	Last Cal.	Next Cal.
<input checked="" type="checkbox"/>	MXE EMI Receiver	KESIGHT	N9038A	MY56400036	Oct.30, 2021	Oct.29, 2022
<input checked="" type="checkbox"/>	Hybrid Log Periodic Antenna	TDK	HLP-3003C	130960	Aug.02, 2021	Aug.01, 2024
<input checked="" type="checkbox"/>	Preamplifier	HP	8447D	2944A09099	Oct.30, 2021	Oct.29, 2022
<input checked="" type="checkbox"/>	EMI Measurement Receiver	R&S	ESR26	101377	Oct.30, 2021	Oct.29, 2022
<input checked="" type="checkbox"/>	Horn Antenna	TDK	HRN-0118	130939	July 20, 2021	July 19, 2024
<input checked="" type="checkbox"/>	High Gain Horn Antenna	Schwarzbeck	BBHA-9170	691	July 20, 2021	July 19, 2024
<input checked="" type="checkbox"/>	Preamplifier	TDK	PA-02-0118	TRS-305-00066	Oct.31, 2021	Oct.30, 2022
<input checked="" type="checkbox"/>	Preamplifier	TDK	PA-02-2	TRS-307-00003	Oct.31, 2021	Oct.30, 2022
<input checked="" type="checkbox"/>	Loop antenna	Schwarzbeck	1519B	00008	Jan.17,2022	Jan.17,2025
<input checked="" type="checkbox"/>	High Pass Filter	Wi	WHKX10-2700-3000-18000-40SS	23	Oct.31, 2021	Oct.30, 2022
Software						
Used	Description	Manufacturer	Name	Version		
<input checked="" type="checkbox"/>	Test Software for Radiated disturbance	Farad	EZ-EMC	Ver. UL-3A1		



7. ANTENNA TERMINAL TEST RESULTS

7.1. EFFECTIVE (ISOTROPIC) RADIATED POWER OF TRANSMITTER

RULE PART(S)

FCC: §2.1046, §22.913, §24.232, §27.50

LIMITS

22.913(a) The ERP of mobile transmitters and auxiliary test transmitters must not exceed 7 Watts.

24.232(c) Mobile/portable stations are limited to 2 watts e.i.r.p. peak power and the equipment must employ means to limit the power to the minimum necessary for successful communications.

27.50(c) Portable stations (hand-held devices) in the 600 MHz uplink band and the 698-746 MHz band, and fixed and mobile stations in the 600 MHz uplink band are limited to 3 watts ERP.

27.50(d) Fixed, mobile, and portable (hand-held) stations operating in the 1710-1755 MHz band and mobile and portable stations operating in the 1695-1710 MHz and 1755-1780 MHz bands are limited to 1 watts EIRP.

27.50(h) Mobile stations are limited to 2.0 watts EIRP. All user stations are limited to 2.0 watts transmitter output power.

In addition, when the transmitter power is measured in terms of average value, the peak-to-average ratio of the power shall not exceed 13 dB.

TEST PROCEDURE

Refer to ANSI C63.26:2015 and KDB 971168 D01 Section 5.6

$ERP/ EIRP = P_{Meas} + GT - LC$

where:

ERP or EIRP = effective or equivalent isotropically radiated power, respectively (expressed in the same units as P_{Meas} , typically dBW or dBm);

P_{Meas} = measured transmitter output power or PSD, in dBm or dBW;

GT = gain of the transmitting antenna, in dBd (ERP) or dBi (EIRP);

LC = signal attenuation in the connecting cable between the transmitter and antenna, in dB

The transmitter has a maximum radiated ERP / EIRP output powers as follows:



TEST SETUP

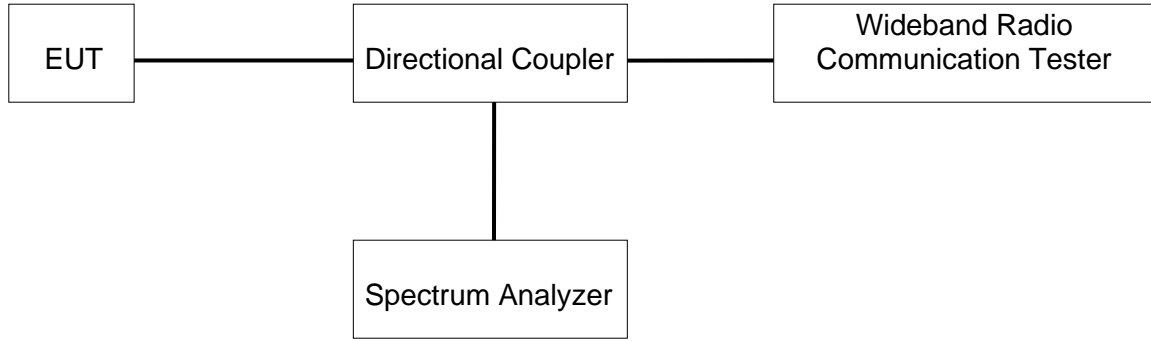

TEST ENVIRONMENT

Temperature	22.8°C	Relative Humidity	64.7%
Atmosphere Pressure	101kPa	Test Voltage	DC 48.1 V

MAXIMUM EIRP/ERP FOR EACH BAND

GSM 850				
Part 22H				
ERP Limit(W)	7			
Antenna Gain (dBi)	2			
Mode	Ch	Freq(MHz)	Conducted Average power (dBm)	ERP (W)
GRPS(GMSK)	251	848.8	33.82	2.33

GSM 1900				
Part 24				
EIRP Limit(W)	2			
Antenna Gain (dBi)	2.8			
Mode	Ch	Freq(MHz)	Conducted Average power (dBm)	EIRP (W)
GRPS(GMSK)	810	1909.8	28.86	1.47

WCDMA Band2				
Part 24				
EIRP Limit(W)	2			
Antenna Gain (dBi)	2.8			
Mode	Ch	Freq(MHz)	Conducted Average power (dBm)	EIRP (W)
Rel99	9400	1907.6	22.17	0.31



WCDMA Band4				
Part 27				
EIRP Limit(W)		1		
Antenna Gain (dBi)		2.8		
Mode	Ch	Freq(MHz)	Conducted Average	EIRP
			power (dBm)	(W)
Rel99	1413	1732.6	22.54	0.34



RESULTS

GSM 850

Band		Conducted Average Power (dBm)		
		Channel	Channel	Channel
		128	190	251
GPRS850	TestSlot 1	33.71	33.79	33.82
	TestSlot 2	31.07	31.54	31.71
	TestSlot 3	29.43	30.15	30.22
	TestSlot 4	28.32	29.04	28.74
EGPRS850	TestSlot 1	25.87	26.44	26.37
	TestSlot 2	24.66	25.2	25.2
	TestSlot 3	22.94	23.57	23.62
	TestSlot 4	21.75	22.39	22.47

GSM 1900

Band		Conducted Average Power (dBm)		
		Channel	Channel	Channel
		512	661	810
GPRS1900	TestSlot 1	27.51	27.89	28.86
	TestSlot 2	26.77	27.15	27.63
	TestSlot 3	24.77	25.4	25.8
	TestSlot 4	23.8	23.99	24.43
EGPRS1900	TestSlot 1	24.2	24.6	25.18
	TestSlot 2	23.51	23.82	24.33
	TestSlot 3	22.25	22.51	23.03
	TestSlot 4	21.14	21.32	21.74

WCDMA Band2

UMTS 1900MHz (Band II)		Average Power (dBm)		
		9262CH	9400CH	9538CH
WCDMA	12.2kbps RMC	21.88	22.17	22.06
HSDPA	Subtest 1	20.85	21.25	21.04
	Subtest 2	21.06	21.33	21.03
	Subtest 3	21.06	21.32	21.02
	Subtest 4	21.06	21.32	21.02
HSUPA	Subtest 1	19.95	20.56	19.97
	Subtest 2	20.14	20.59	20.56
	Subtest 3	20.35	20.8	20.28
	Subtest 4	20.59	20.77	20.25
	Subtest 5	20.71	21.06	20.82



WCDMA Band4

UMTS 850MHz (Band V)		Average Power (dBm)		
		1312CH	1413CH	1513CH
WCDMA	12.2kbps RMC	22.1	22.54	22.36
HSDPA	Subtest 1	21.11	21.54	21.42
	Subtest 2	21.44	21.54	21.41
	Subtest 3	21.44	21.54	21.41
	Subtest 4	21.44	21.54	21.41
HSUPA	Subtest 1	20.25	20.71	20.95
	Subtest 2	20.77	20.79	20.87
	Subtest 3	20.86	21.25	20.67
	Subtest 4	20.87	21.26	20.15
	Subtest 5	20.76	21.36	21.11

7.2. PEAK TO AVERAGE RADIO

LIMITS

In addition, when the transmitter power is measured in terms of average value, the peak-to-average ratio of the power shall not exceed 13 dB.

TEST PROCEDURE

Refer to KDB 971168 D01 Power Meas License Digital Systems v03r01;

The transmitter output was connected to a CMW500 Test Set and configured to operate at maximum power. The PAR was measured on the Spectrum Analyzer.

TEST SETUP

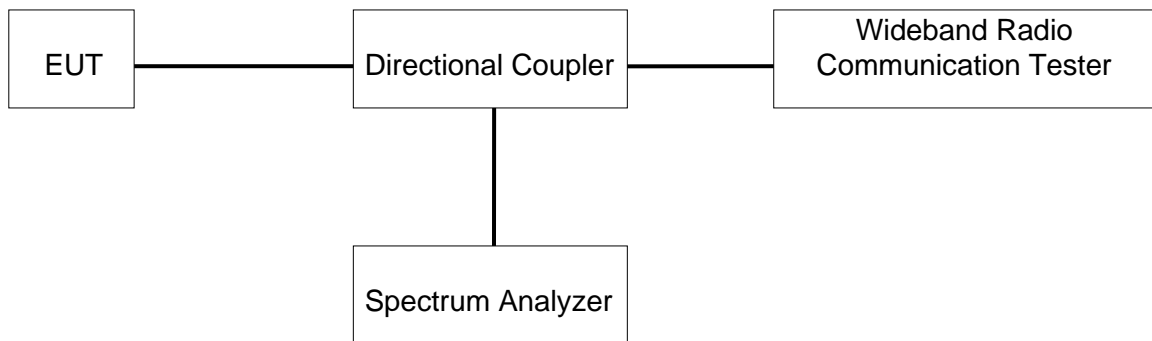

TEST ENVIRONMENT

Temperature	22.7°C	Relative Humidity	65.6%
Atmosphere Pressure	101kPa	Test Voltage	DC 48.1 V

RESULTS

Band	Channel	Result(dB)	Limit(dB)	Verdict
GPRS850	190	9.74	13	PASS
EGPRS850	190	12.78	13	PASS
GPRS1900	661	9.82	13	PASS
EGPRS1900	661	12.66	13	PASS

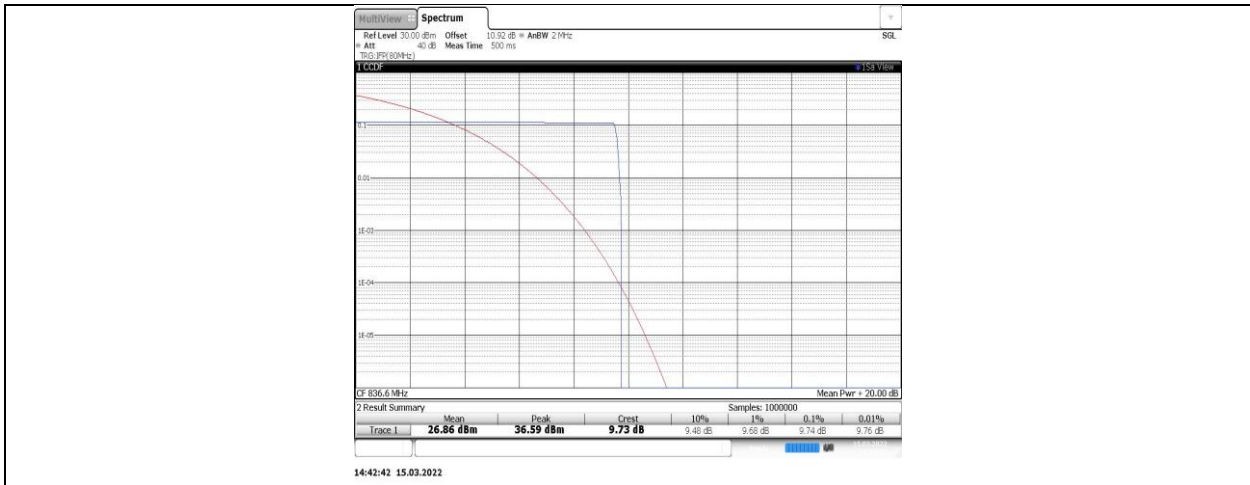

GPRS850-190

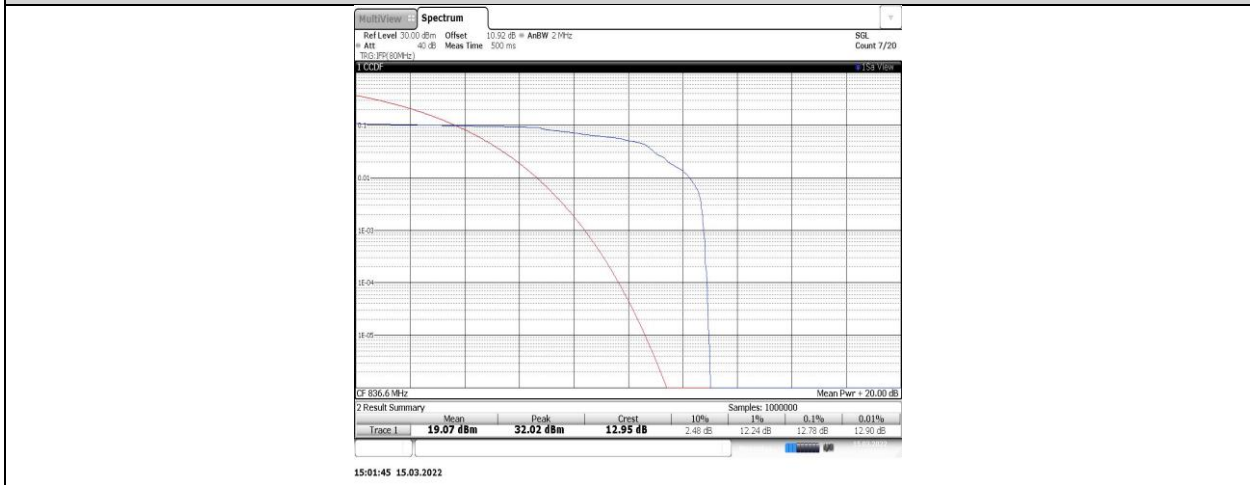

EGPRS850-190

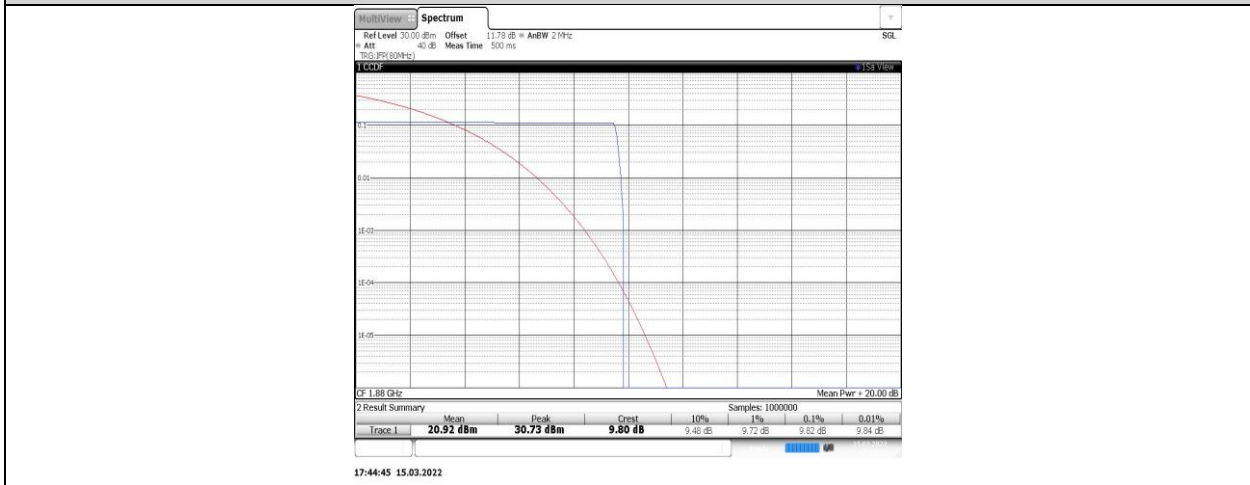

GPRS1900-661

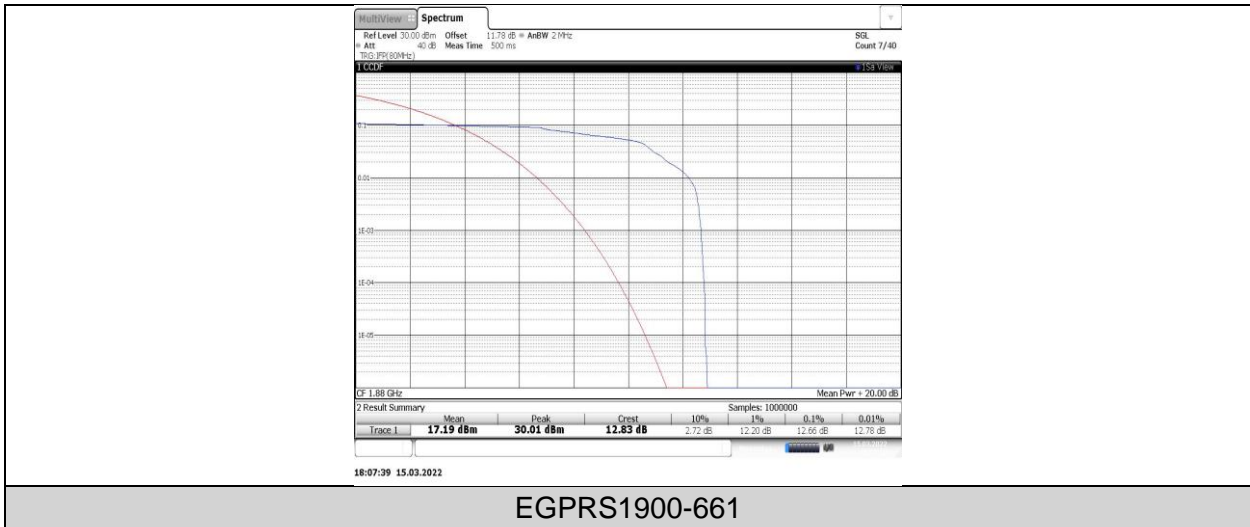

EGPRS1900-661

WCDMA

Band	Channel	SubTest	Peak-to-Average Ratio(dB)	Limit(dB)	Verdict
Band2	9400	Rel99	3.18	13	PASS
	9400	HSDPA	3.26	13	PASS
	9400	HSUPA	4.34	13	PASS
Band4	1413	Rel99	3.26	13	PASS
	1413	HSDPA	3.22	13	PASS
	1413	HSUPA	4.28	13	PASS

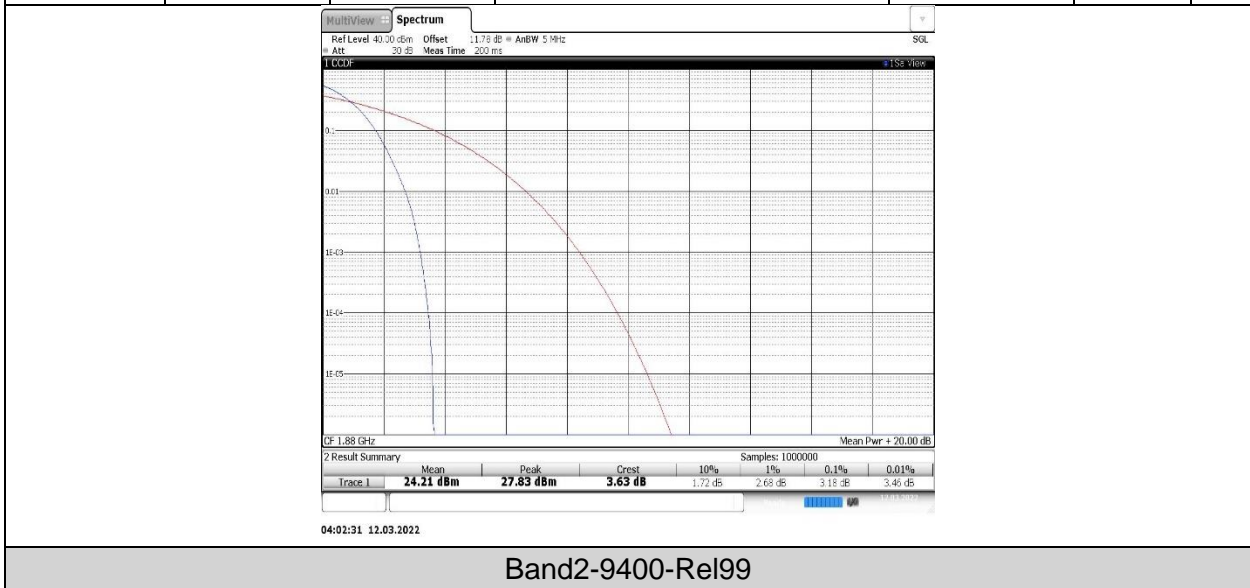

Band2-9400-Rel99

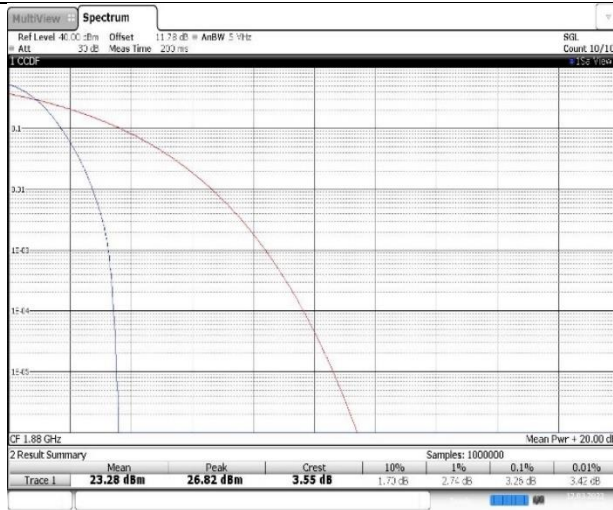

04:21:29 12.03.2022

Band2-9400-HSDPA

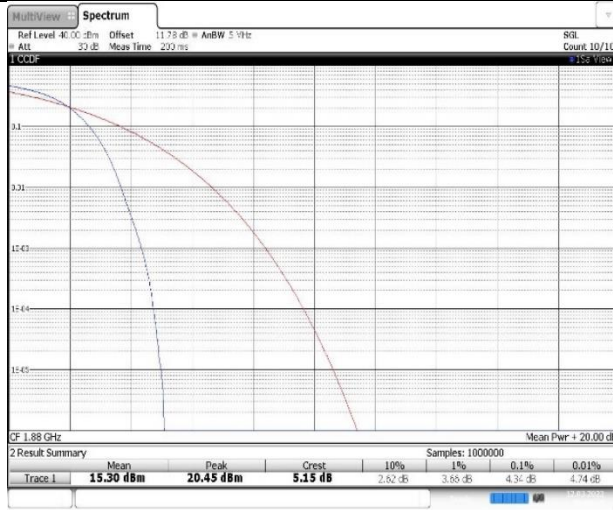

08:09:49 12.03.2022

Band2-9400-HSUPA

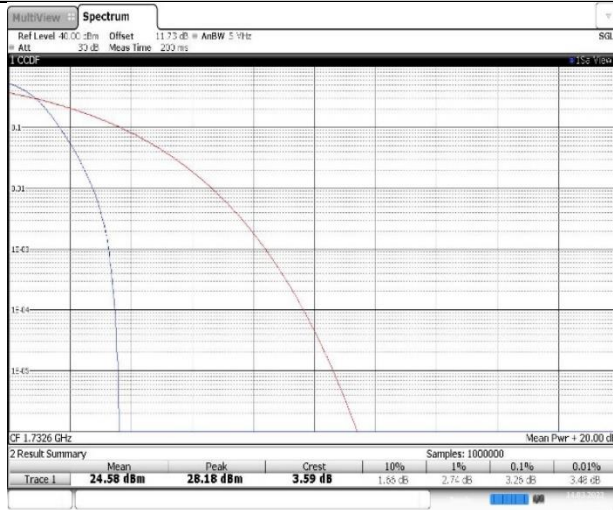

17:27:52 14.03.2022

Band4-1413-Rel99

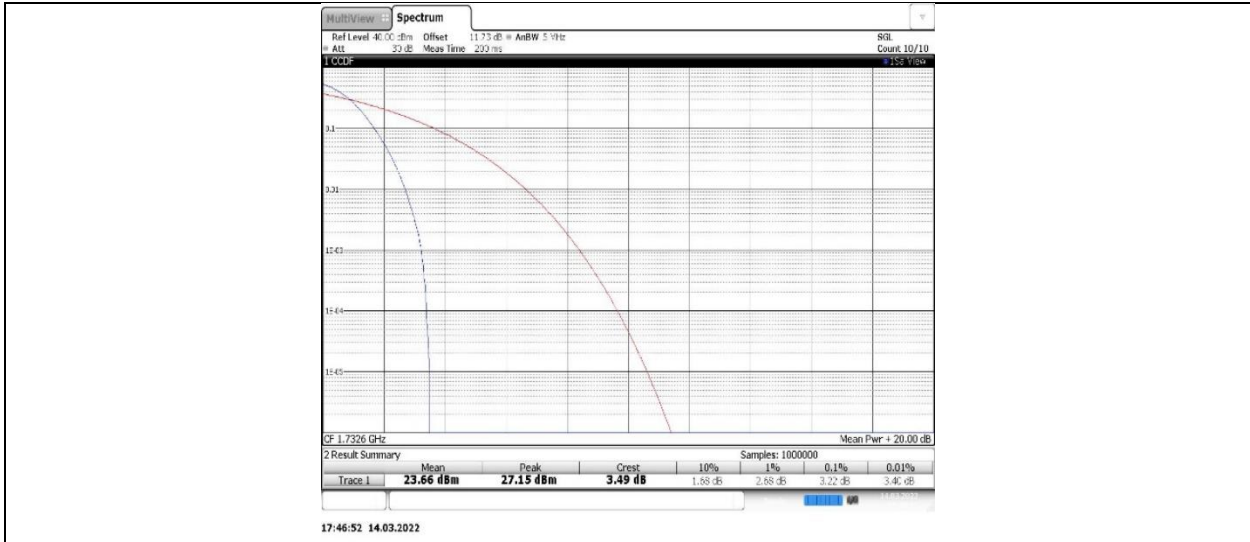

Band4-1413-HSDPA

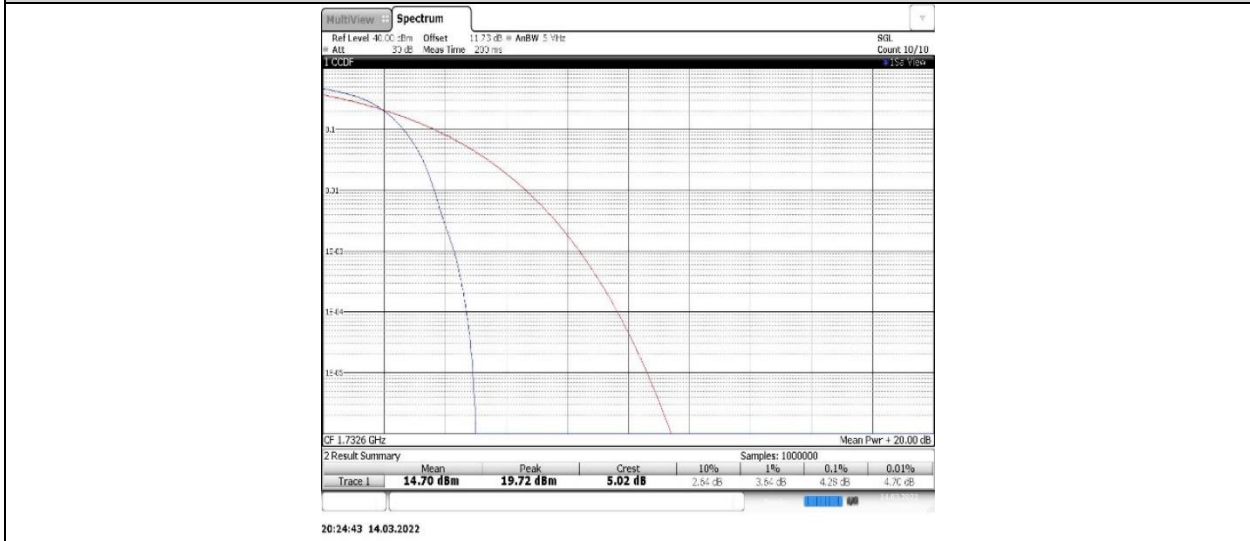

Band4-1413-HSUPA

7.3. OCCUPIED BANDWIDTH

RULE PART(S)

FCC: §2.1049.

LIMITS

For reporting purposes only.

TEST PROCEDURE

The transmitter output was connected to a calibrated coaxial cable and coupler, the other end of which was connected to a spectrum analyzer. The occupied bandwidth was measured with the spectrum analyzer at the low, middle and high channel in each band. The -26dB bandwidth was also measured and recorded.

(Refer to KDB 971168 D01 Power Meas License Digital Systems v03r01)

TEST SETUP

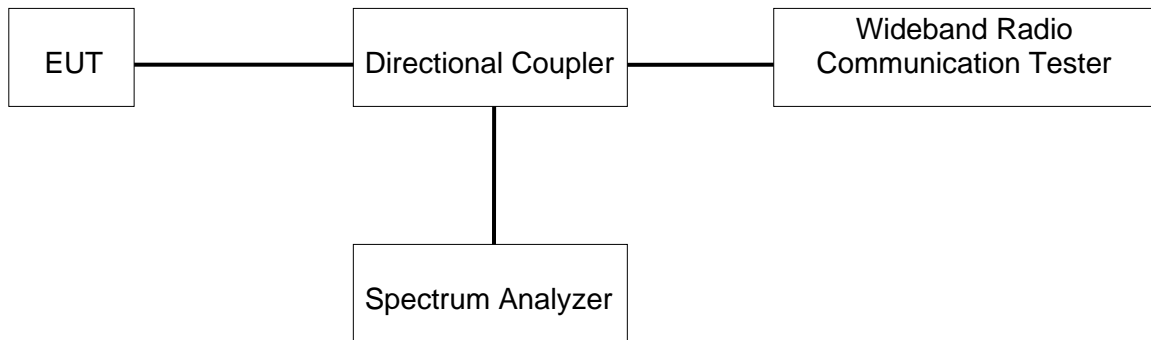

TEST ENVIRONMENT

Temperature	22.7°C	Relative Humidity	65.6%
Atmosphere Pressure	101kPa	Test Voltage	DC 48.1 V

RESULTS

Band	Channel	Occupied Bandwidth (MHz)	26dB Bandwidth (MHz)	Limit (MHz)	Verdict
GPRS850	190	0.245	0.30	---	PASS
EGPRS850	190	0.243	0.30	---	PASS
GPRS1900	661	0.244	0.32	---	PASS
EGPRS1900	661	0.244	0.31	---	PASS

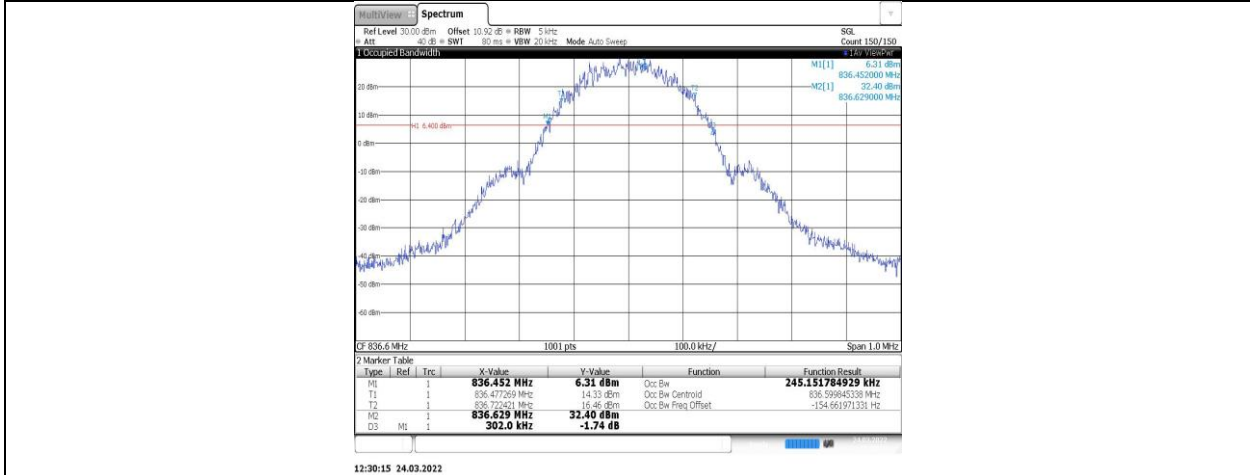

GPRS850-190-3-0.30

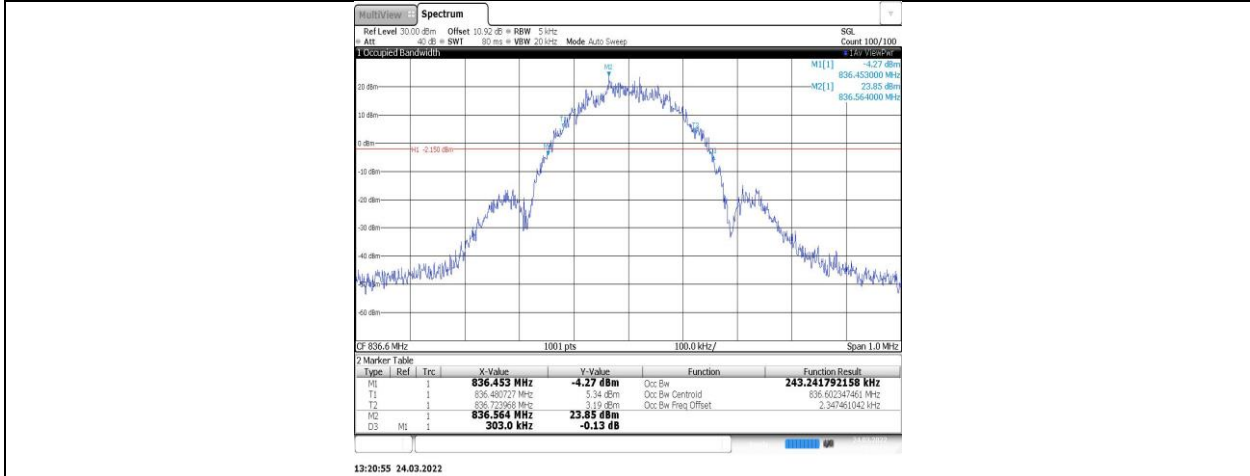

EGPRS850-190-8-0.30

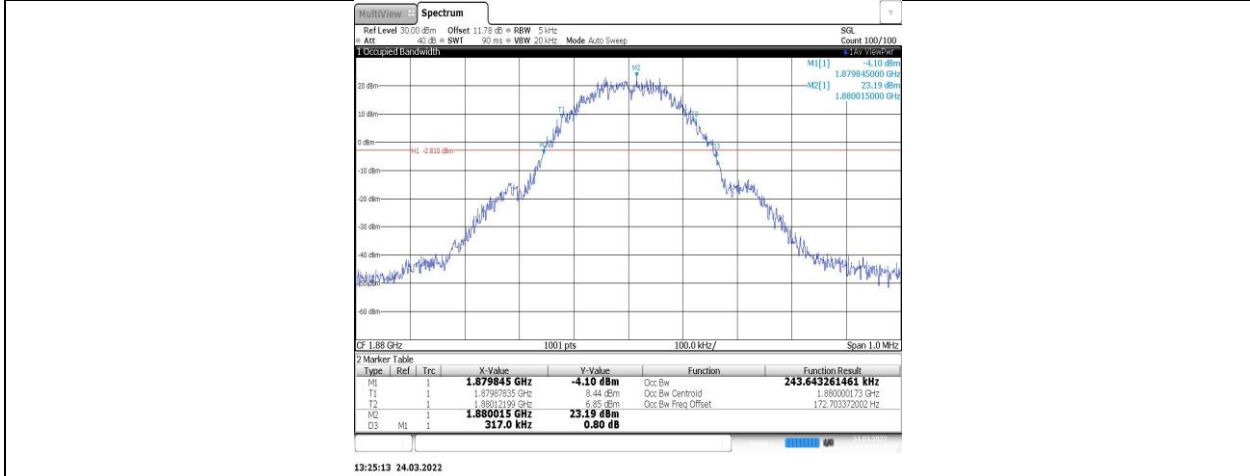

GPRS1900-661-0-0.32

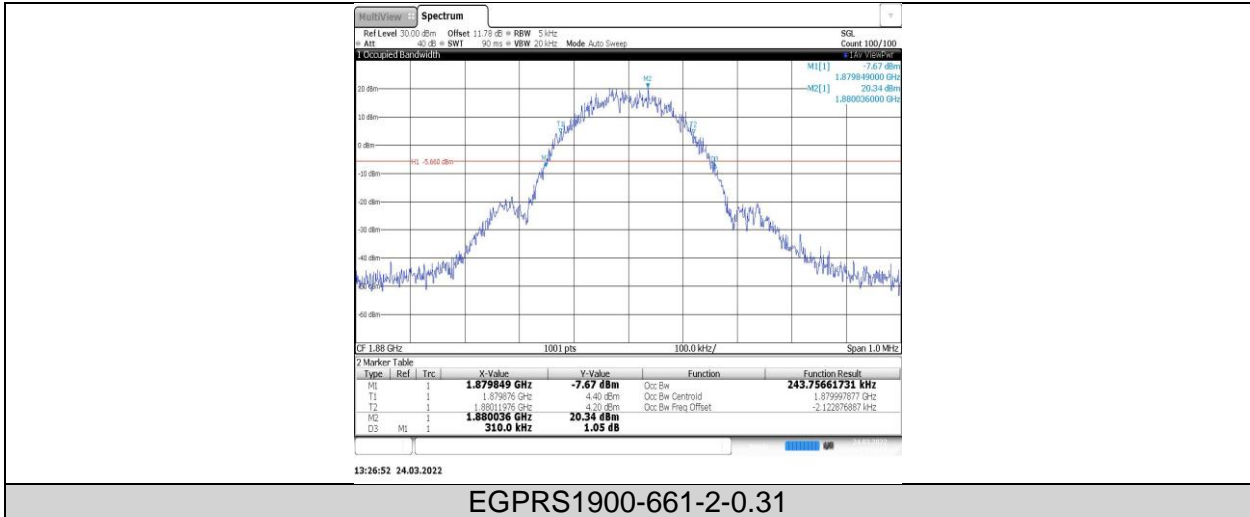



WCDMA

Band	Channel	SubTest	Occupied Bandwidth (kHz)	26dB Bandwidth (kHz)
Band2	Mid	Rel99	4.133	4.73
	Mid	HSDPA	4.133	4.71
	Mid	HSUPA	4.169	4.75
Band4	Mid	Rel99	4.132	4.71
	Mid	HSDPA	4.14	4.73
	Mid	HSUPA	4.165	4.76

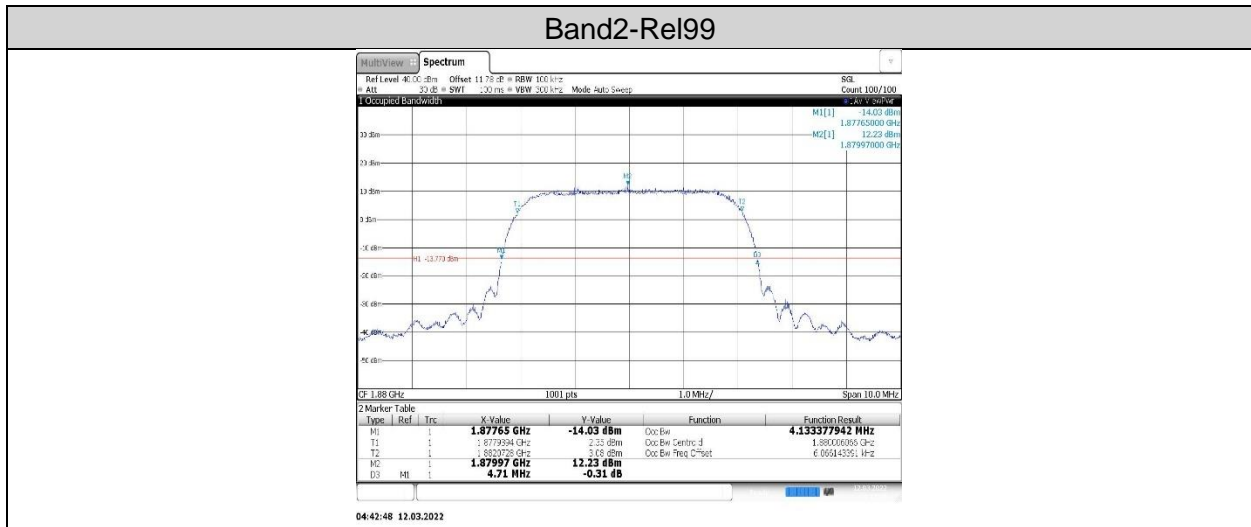
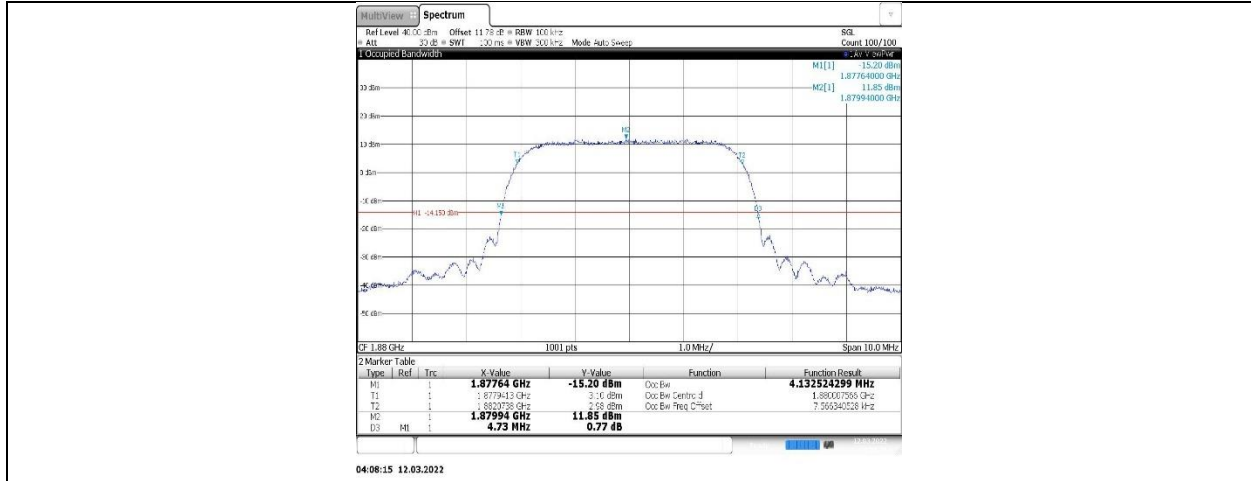

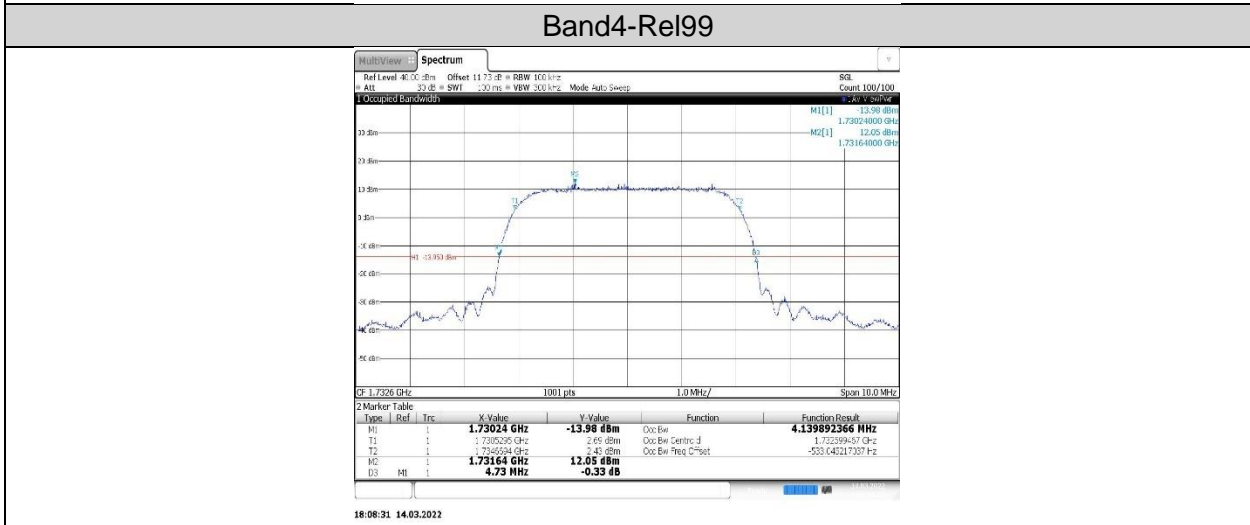
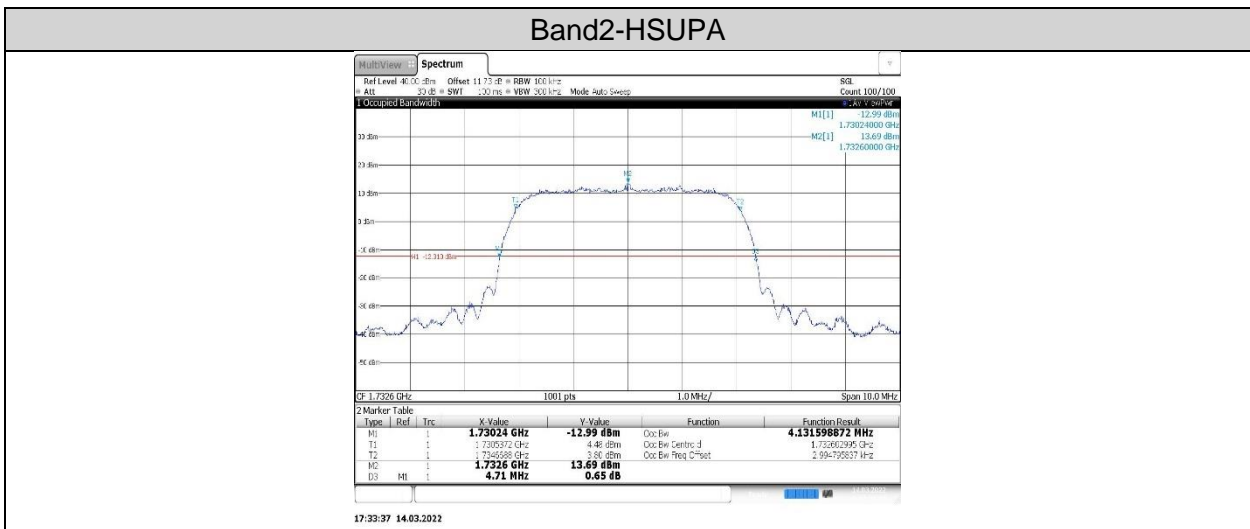
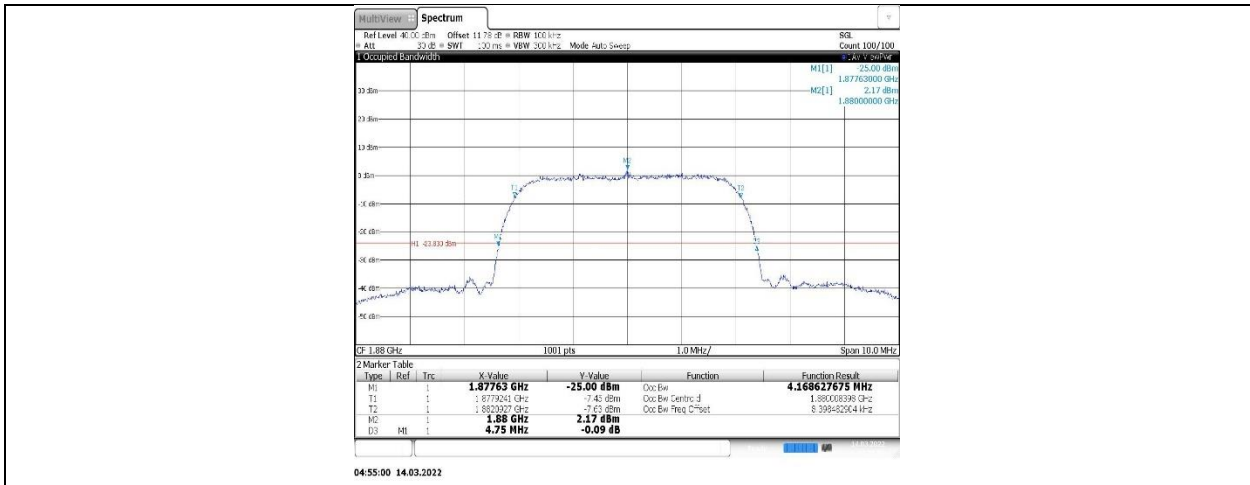

Band4-HSDPA

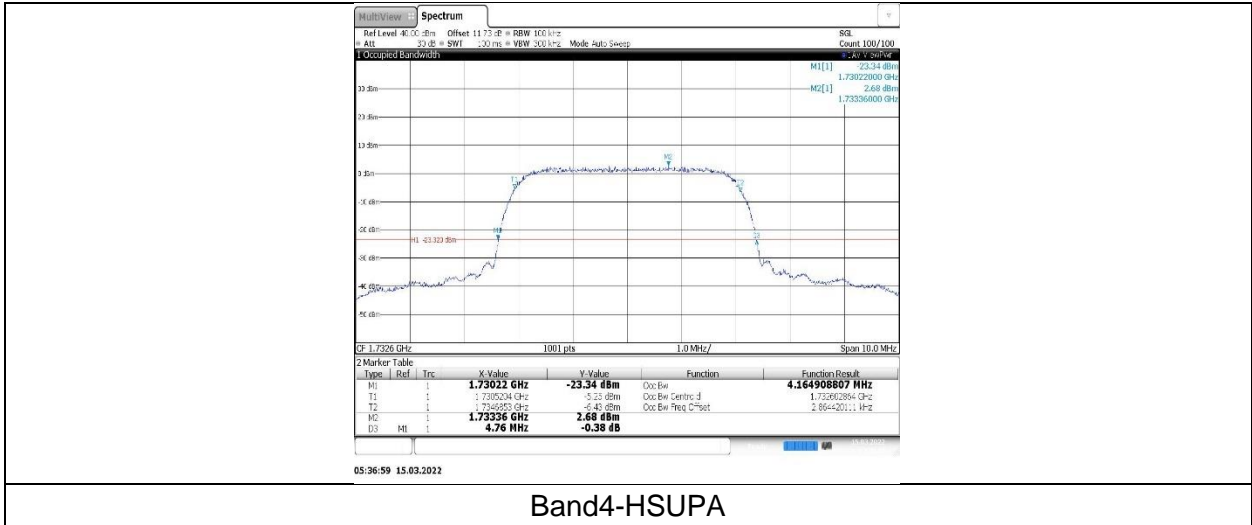

7.4. BAND EDGE EMISSIONS

RULE PART(S)

FCC §2.1051, §22.917, §24.238, §27.53, §90,

LIMITS

The power of any emission outside of the authorized operating frequency ranges must be attenuated below the transmitting power (P) by a factor of at least $43 + 10 \log (P)$ dB.

TEST PROCEDURE

Refer to KDB 971168 D01 Power Meas License Digital Systems v03r01

The transmitter output was connected to a CMW500 Test Set and configured to operate at maximum power. The band edge emissions were measured at the required operating frequencies in each band on the Spectrum Analyzer.

- a) Set the RBW = 1 ~ 1.5 % of OBW (Typically limited to a minimum RBW of 1% of the OBW)
- b) Set VBW $\geq 3 \times$ RBW;
- c) Set span ≥ 1.5 times the OBW;
- d) Sweep time = Auto;
- e) Detector = RMS;
- f) Ensure that the number of measurement points $\geq 2 \times$ Span/RBW;
- g) Trace mode = Average (100);

Test procedure for LTE Band 41

Measurement procedure. Compliance with these rules is based on the use of measurement instrumentation employing a resolution bandwidth of 1 megahertz or greater. However, in the 1 MHz bands immediately outside and adjacent to the frequency block a resolution bandwidth of at least one percent of the emission bandwidth of the fundamental emission of the transmitter may be employed; for mobile digital stations, in the 1 megahertz bands immediately outside and adjacent to the frequency block a resolution bandwidth of at least two percent may be employed, except when the 1 megahertz band is 2495-2496 MHz, in which case a resolution bandwidth of at least one percent may be employed. A narrower resolution bandwidth is permitted in all cases to improve measurement accuracy provided the measured power is integrated over the full required measurement bandwidth (i.e. 1 megahertz or 1 percent of emission bandwidth, as specified; or 1 megahertz or 2 percent for mobile digital stations, except in the band 2495-2496 MHz). The emission bandwidth is defined as the width of the signal between two points, one below the carrier center frequency and one above the carrier center frequency, outside of which all emissions are attenuated at least 26 dB below the transmitter power. With respect to television operations, measurements must be made of the separate visual and aural operating powers at sufficiently frequent intervals to ensure compliance with the rules.

TEST SETUP

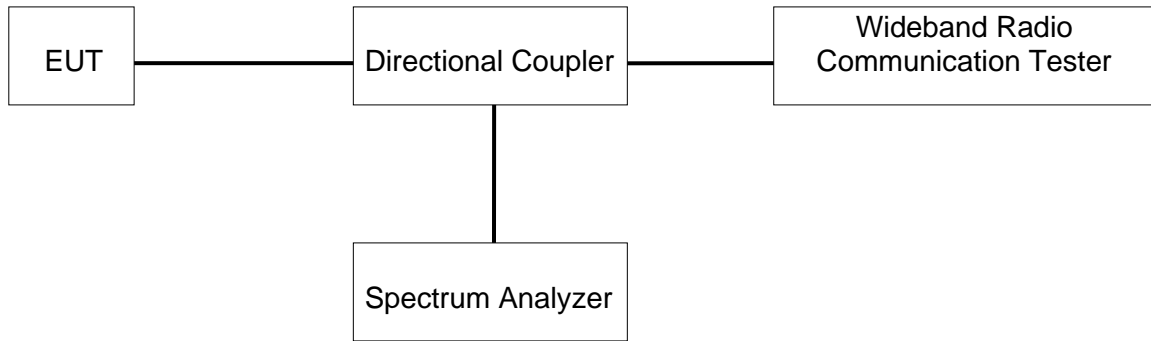

TEST ENVIRONMENT

Temperature	22.7°C	Relative Humidity	65.6%
Atmosphere Pressure	101kPa	Test Voltage	DC 48.1 V

RESULTS

GSM

Band	Channel	Freq (MHz)	Result (dBm)	Limit(dBm)	Verdict
GPRS850	128	824.00	-20.69	-13	PASS
GPRS850	251	849.00	-20.39	-13	PASS
EGPRS850	128	823.97	-19.04	-13	PASS
EGPRS850	251	849.02	-14.76	-13	PASS
GPRS1900	512	1849.98	-14.03	-13	PASS
GPRS1900	810	1910.02	-13.59	-13	PASS
EGPRS1900	512	1849.99	-18.95	-13	PASS
EGPRS1900	810	1910.02	-20.86	-13	PASS

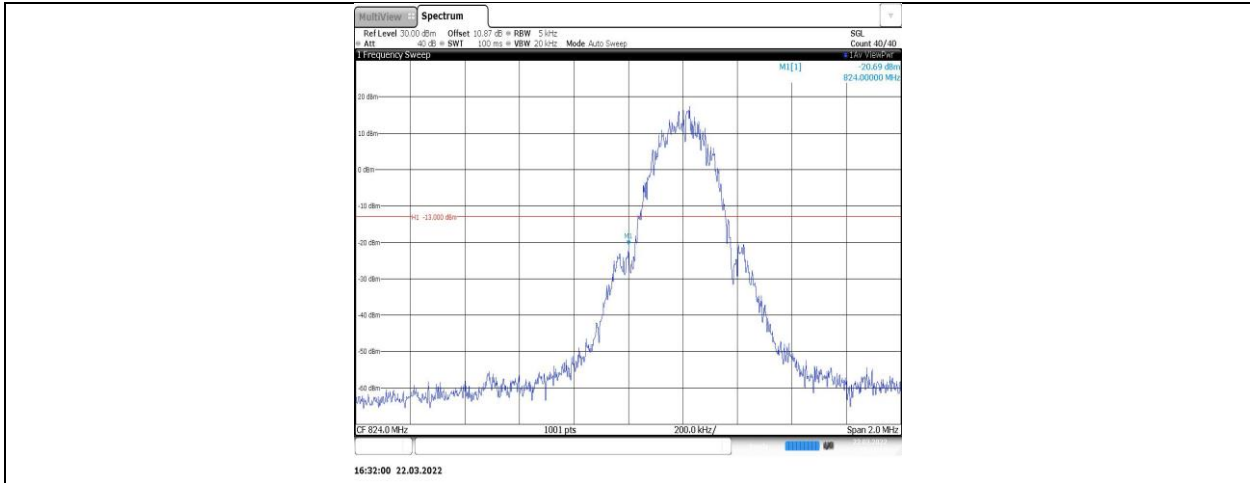

GPRS850-128-3

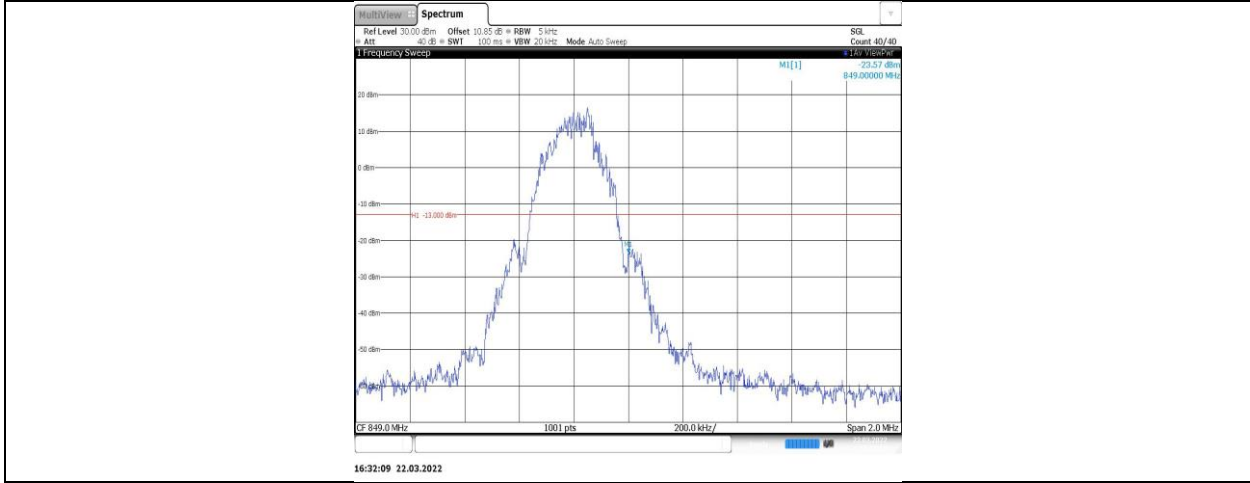

GPRS850-251-3

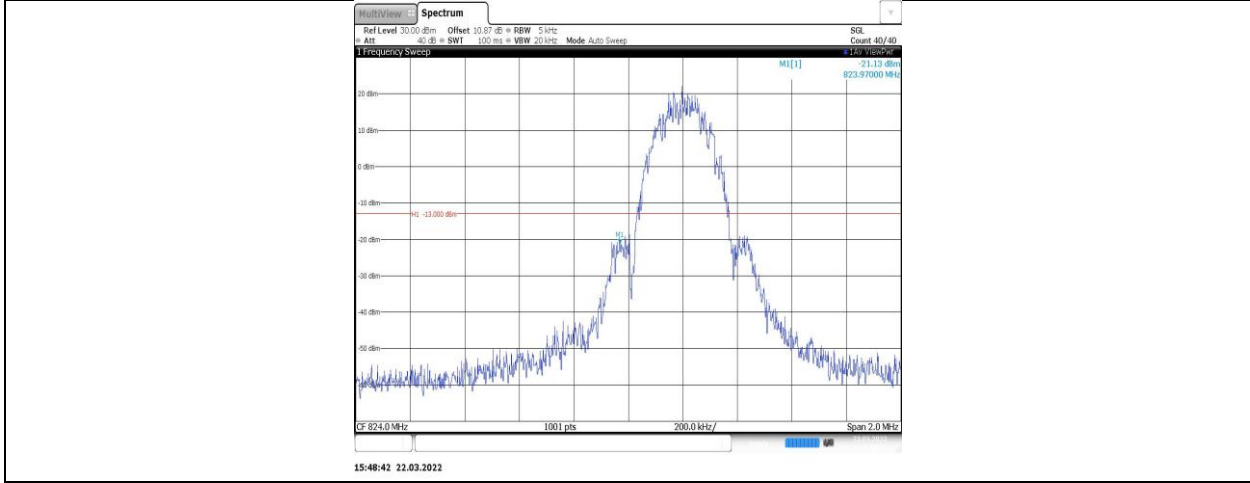

EGPRS850-128-8

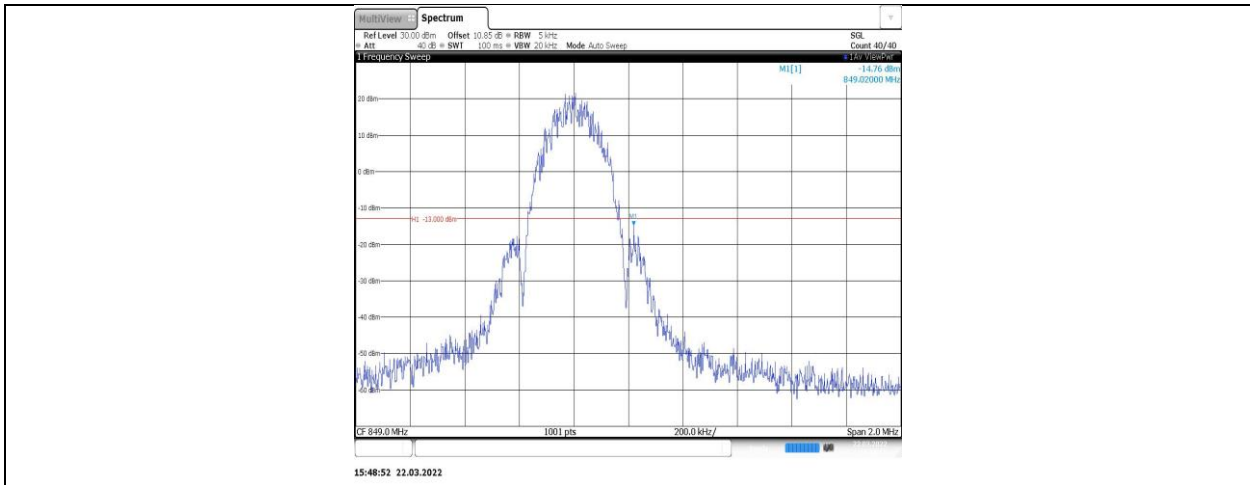

EGPRS850-251-8

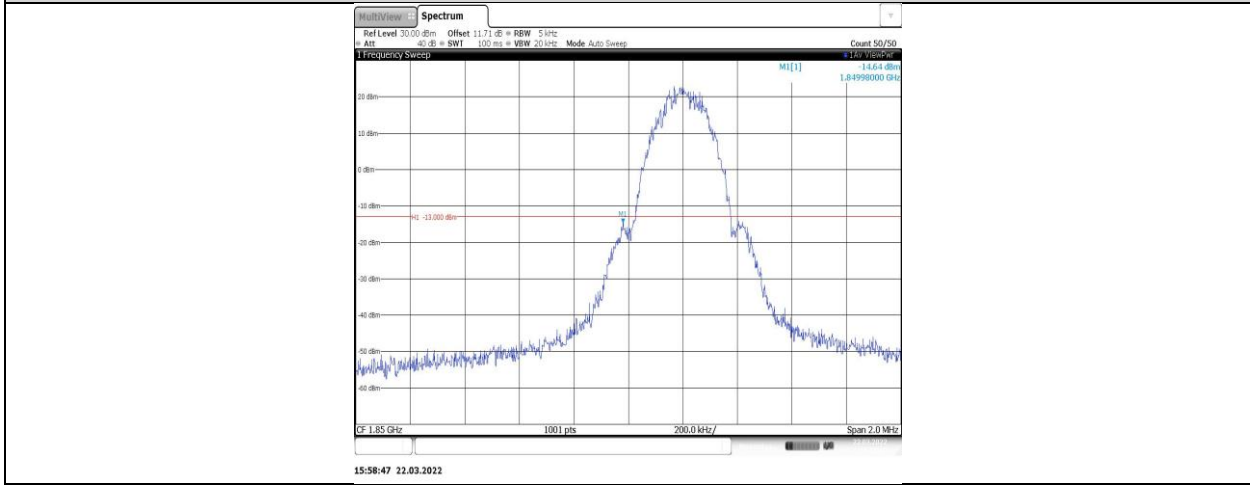

GPRS1900-512-0

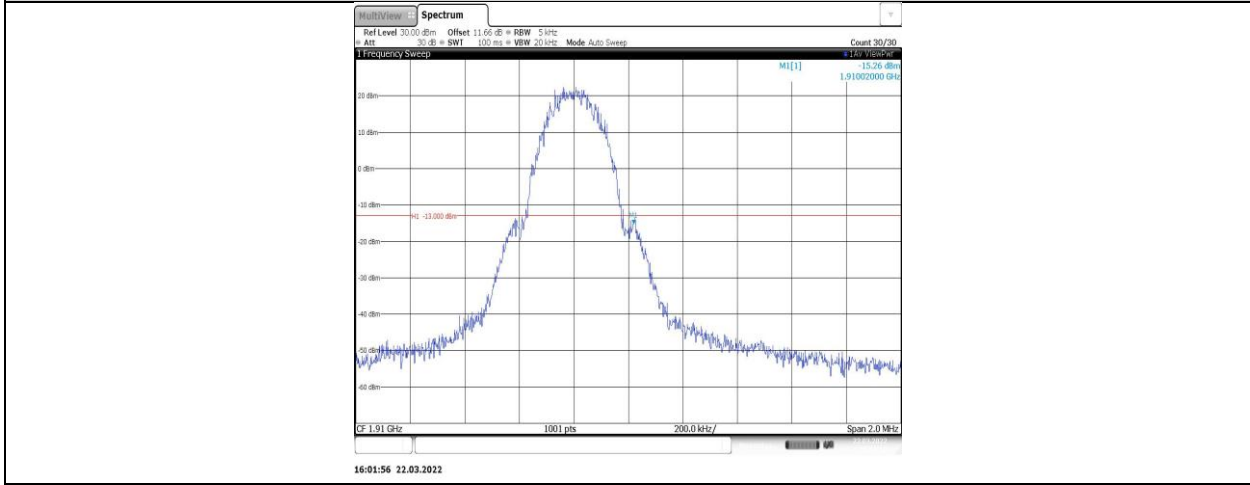

GPRS1900-810-0

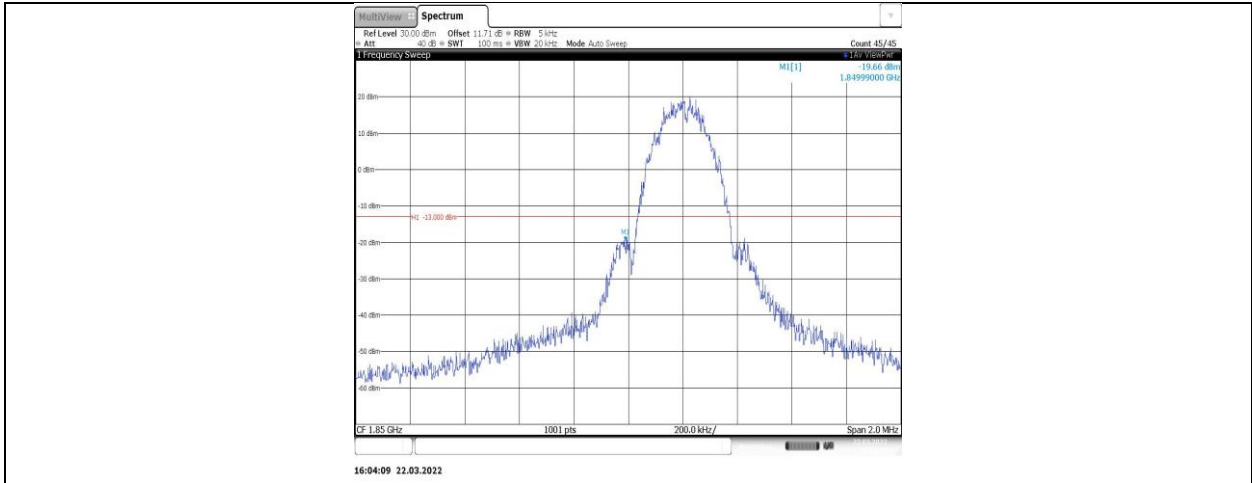

EGPRS1900-512-2

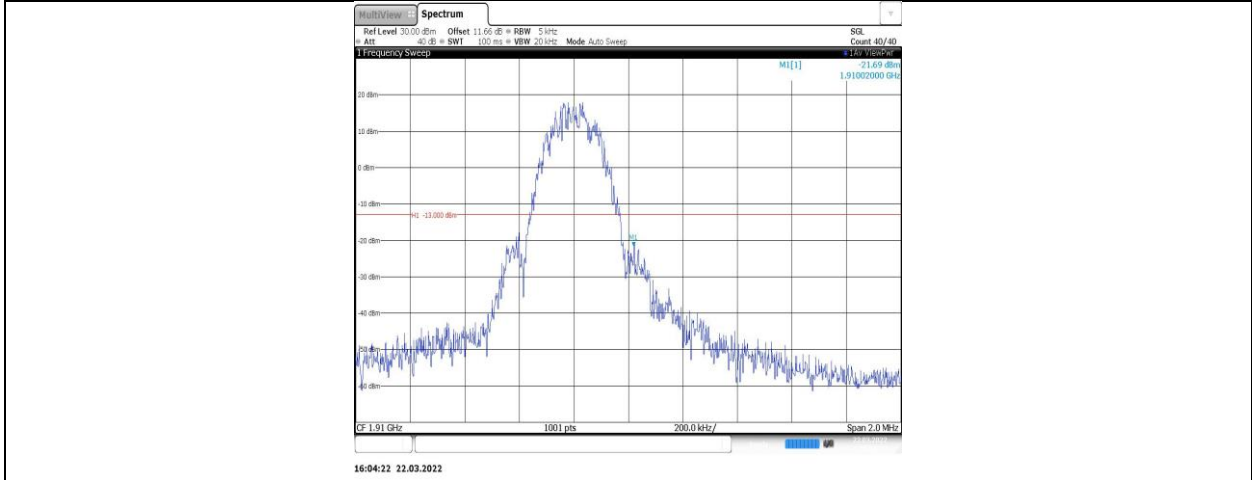

EGPRS1900-810-2



Rel99

Band	Channel	Frequency (MHz)	Result (dBm)	Limit(dBm)	Verdict
Band2	9262	1850.00	-24.51	-13	PASS
Band2	9538	1910.00	-24.44	-13	PASS
Band4	1312	1709.85	-23.88	-13	PASS
Band4	1513	1755.00	-25.50	-13	PASS

HSDPA:

Band	Channel	SubTest	Frequency (MHz)	Result (dBm)	Limit(dBm)	Verdict
Band2	9262	4	1850.00	-25.00	-13	PASS
Band2	9538	4	1910.00	-25.94	-13	PASS
Band4	1312	4	1710.00	-25.64	-13	PASS
Band4	1513	4	1755.00	-24.53	-13	PASS

HSUPA:

Band	Channel	SubTest	Frequency (MHz)	Result (dBm)	Limit(dBm)	Verdict
Band2	9262	5	1850.00	-25.15	-13	PASS
Band2	9538	5	1910.01	-26.21	-13	PASS
Band4	1312	5	1710.00	-24.88	-13	PASS
Band4	1513	5	1755.00	-32.17	-13	PASS

Band2 Rel99

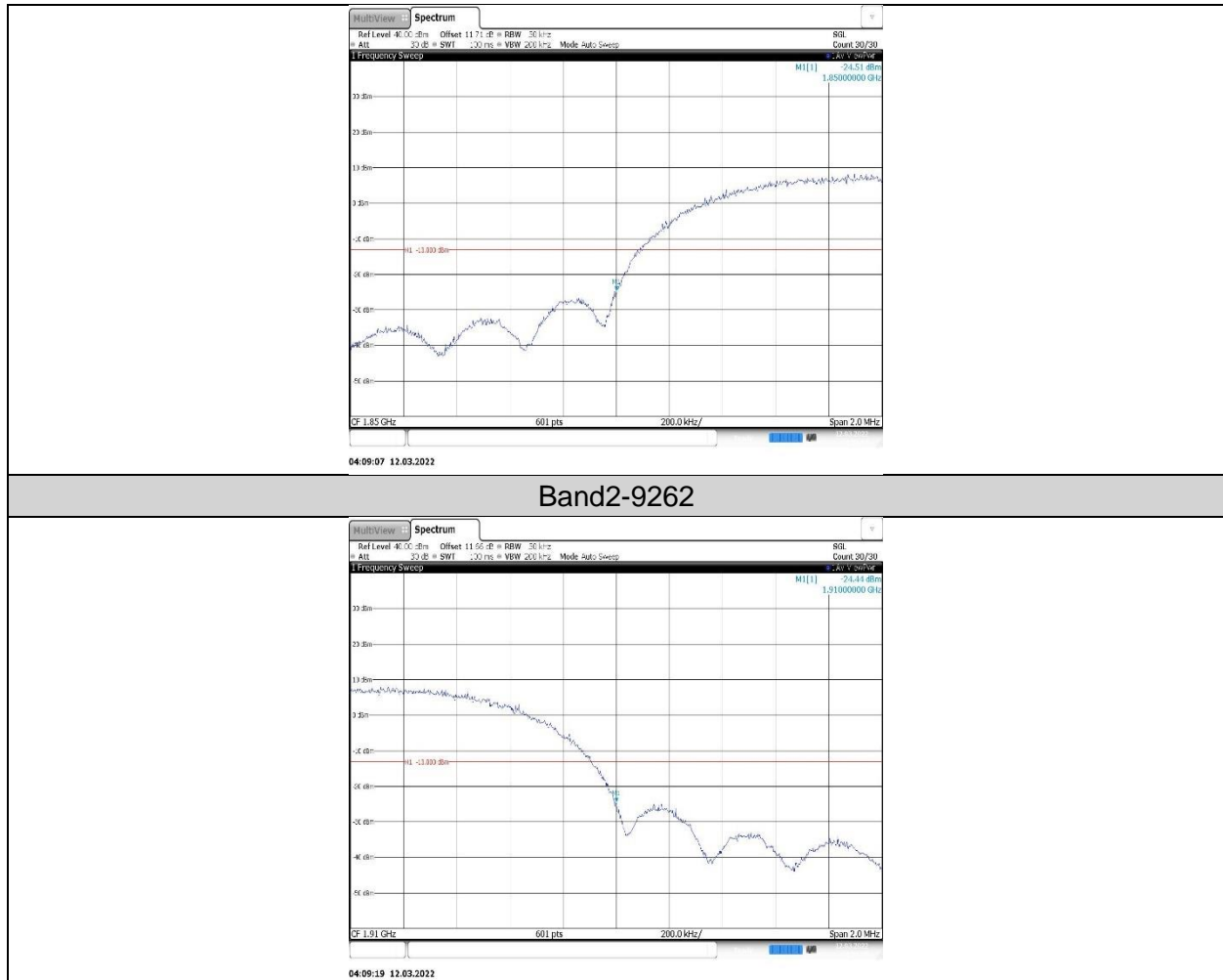



Band2-9538

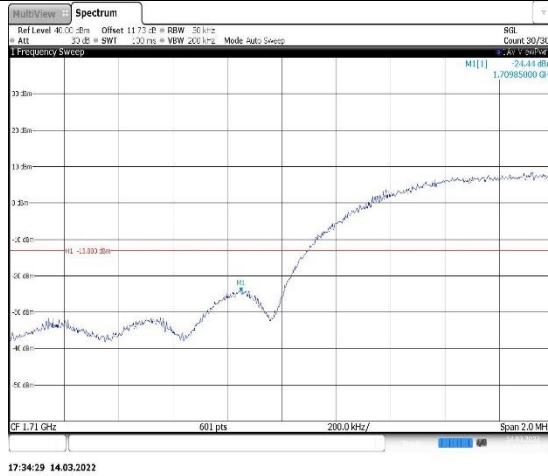

Band4-1312

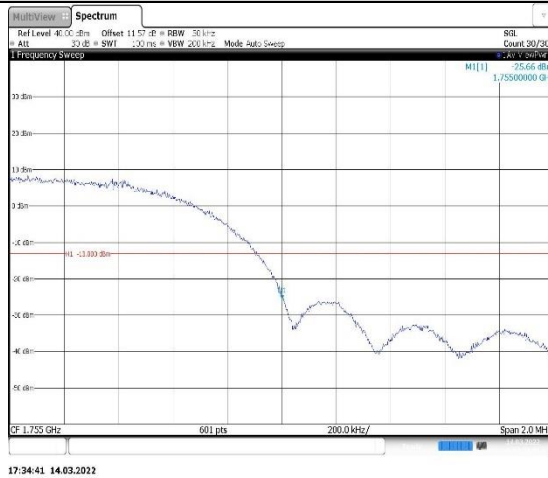

Band4-1513

HSDPA

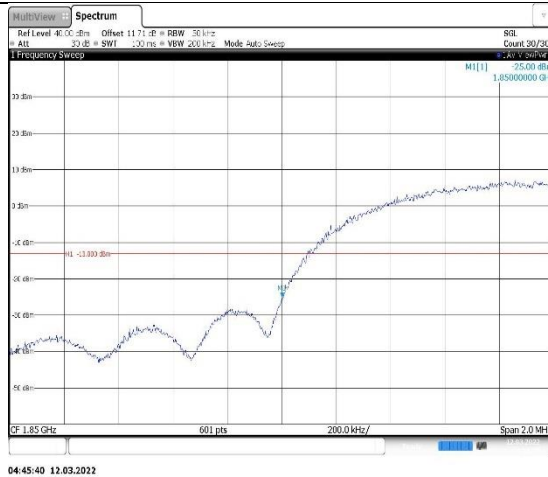

Band2-9262

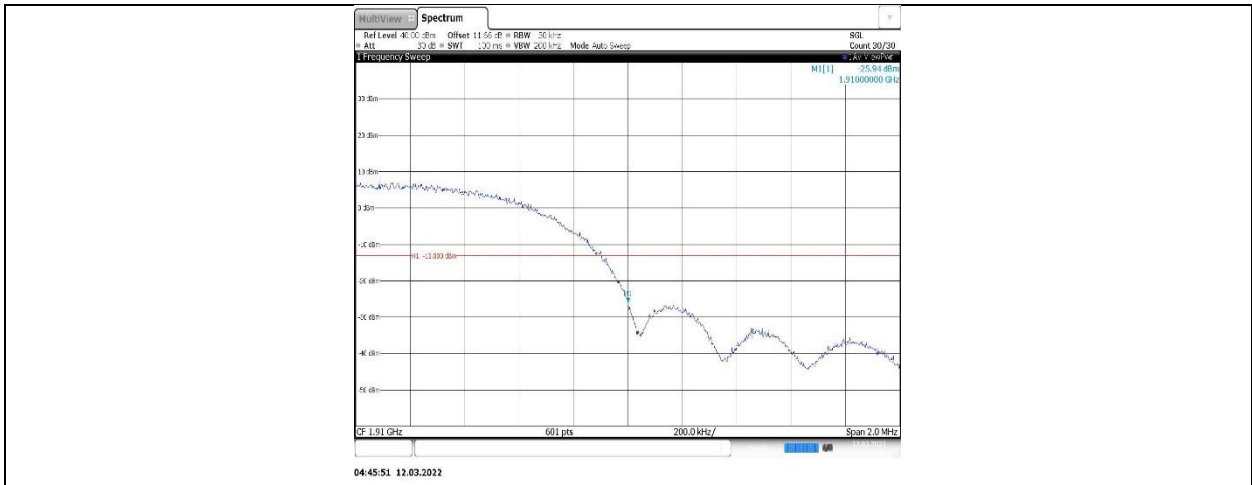

Band2-9538

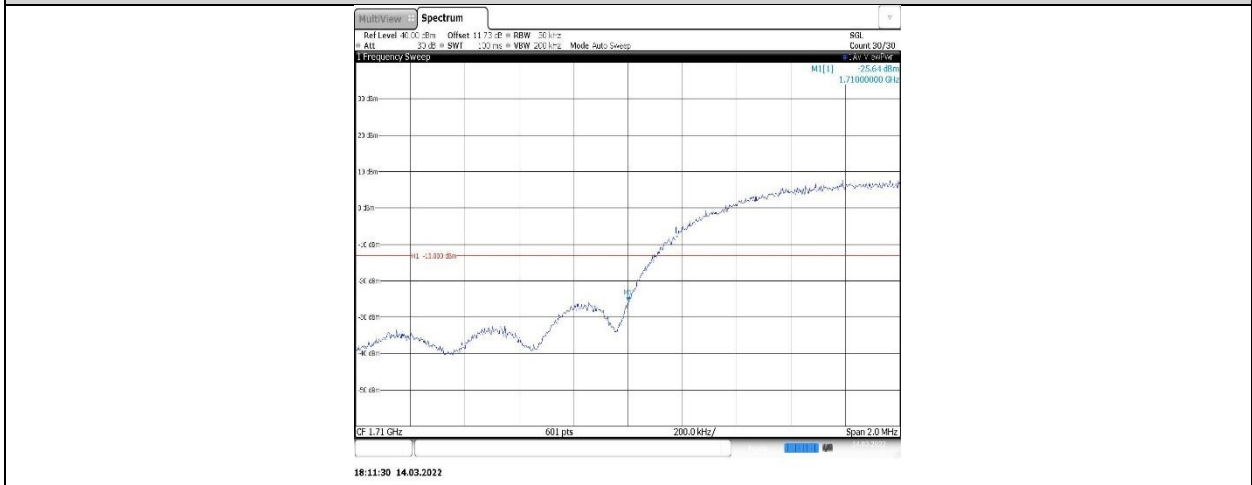

Band4-1312

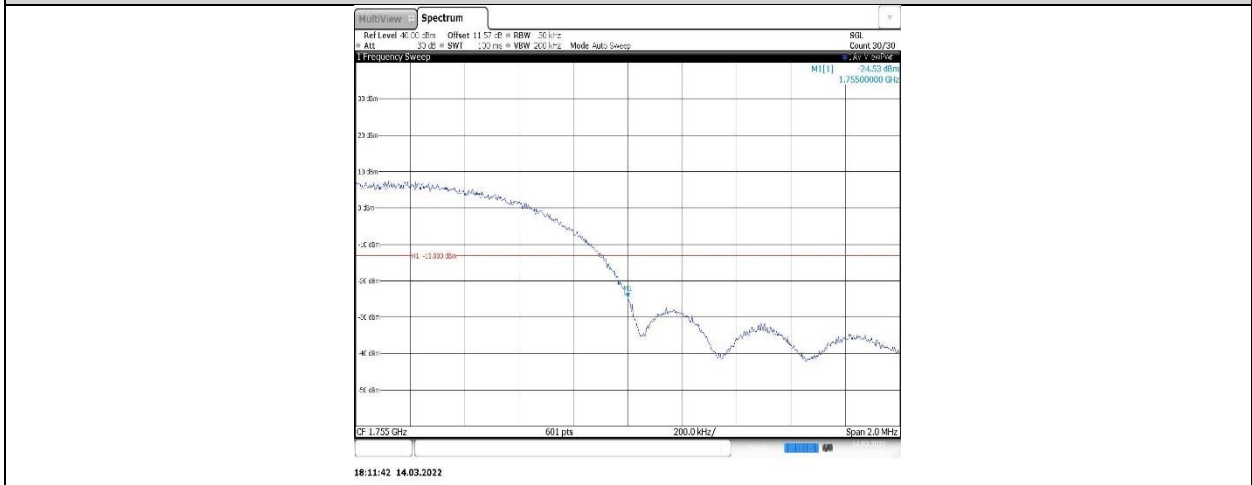

Band4-1513

HSUPA

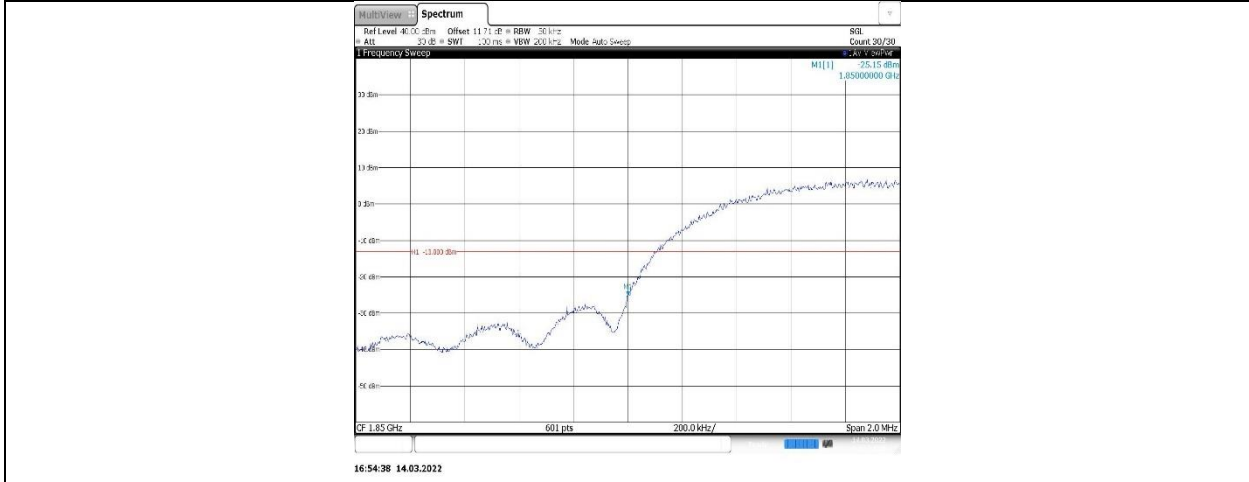

Band2-9262

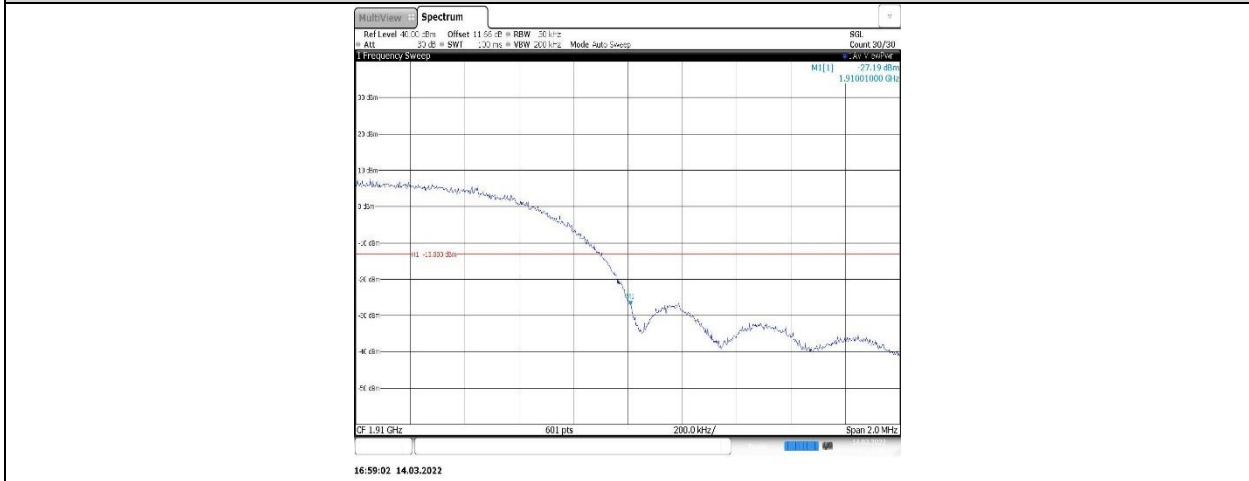

Band2-9538

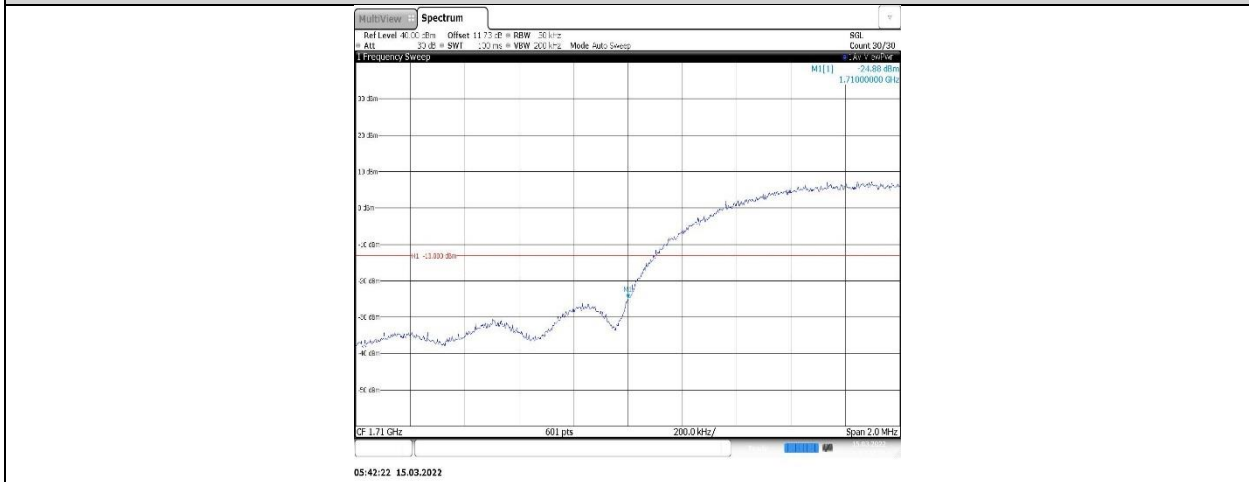

Band4-1312

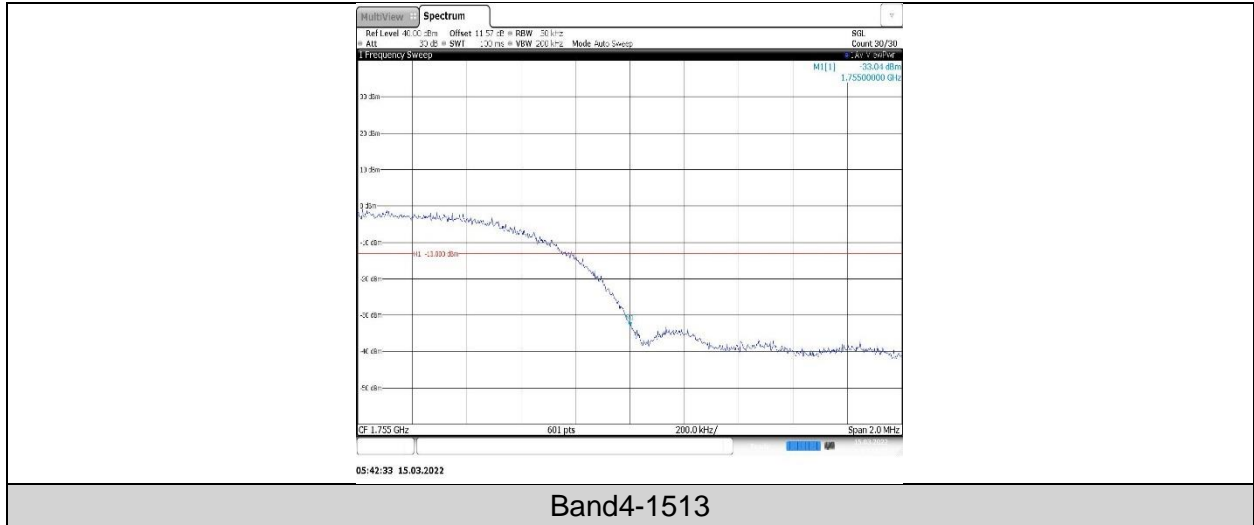

Band4-1513

7.5. SPURIOUS EMISSION AT ANTENNA TERMINAL

RULE PART(S)

FCC: §2.1051, §22.901, §22.917, §24.238, §27.53, §90,

LIMITS

FCC: §22.901, §22.917, §24.238

The power of any emission outside of the authorized operating frequency ranges must be attenuated below the transmitting power (P) by a factor of at least $43 + 10 \log (P)$ dB.

FCC: §27.53(m)(Band 41)

The power of any emission outside of the authorized operating frequency ranges must be attenuated below the transmitting power (P) by a factor of at least $55 + 10 \log (P)$ dB.

TEST PROCEDURE

Per KDB 971168 D01 Power Meas License Digital Systems v03r01

The RF output of the transmitter was connected to a spectrum analyzer through a calibrated coaxial cable. Sufficient scans were taken to show the out-of-band Emissions, if any, up to 10th harmonic. Multiple sweeps were recorded in maximum hold mode using a peak detector to ensure that the worst-case emissions were caught.

- a) Set the RBW = 100 kHz for emission below 1GHz and 1MHz for emissions above 1GHz (Tests were performed 1 MHz [Worst case], to sweep 1 time for all frequency range)
- b) Set VBW $\geq 3 \times$ RBW;
- c) Set span ≥ 1.5 times the OBW;
- d) Sweep time = auto couple;
- e) Detector = rms;
- f) Ensure that the number of measurement points = Max (40001);
- g) Trace mode = average (LTE 5), Maxhold (LTE Band7);

Note: Please refer to section 5.4 for bandwidth and RB setting about LTE bands.

TEST SETUP

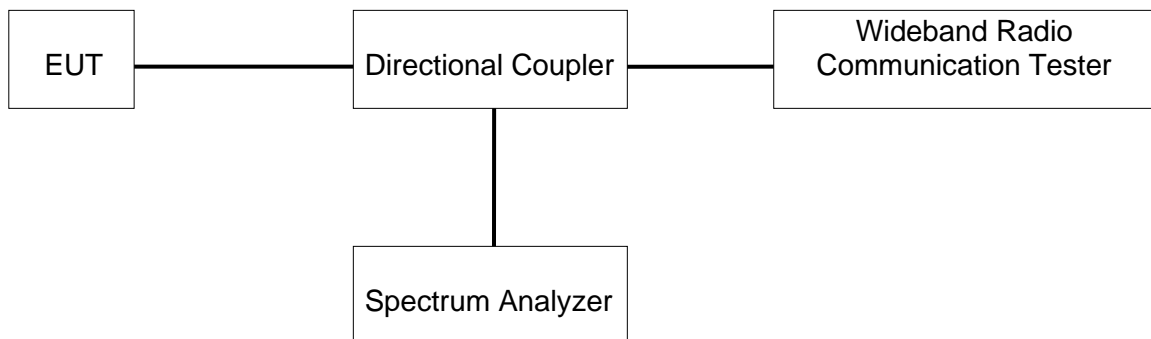



TEST ENVIRONMENT

Temperature	22.7°C	Relative Humidity	65.6%
Atmosphere Pressure	101kPa	Test Voltage	DC 48.1 V

RESULTS

GSM

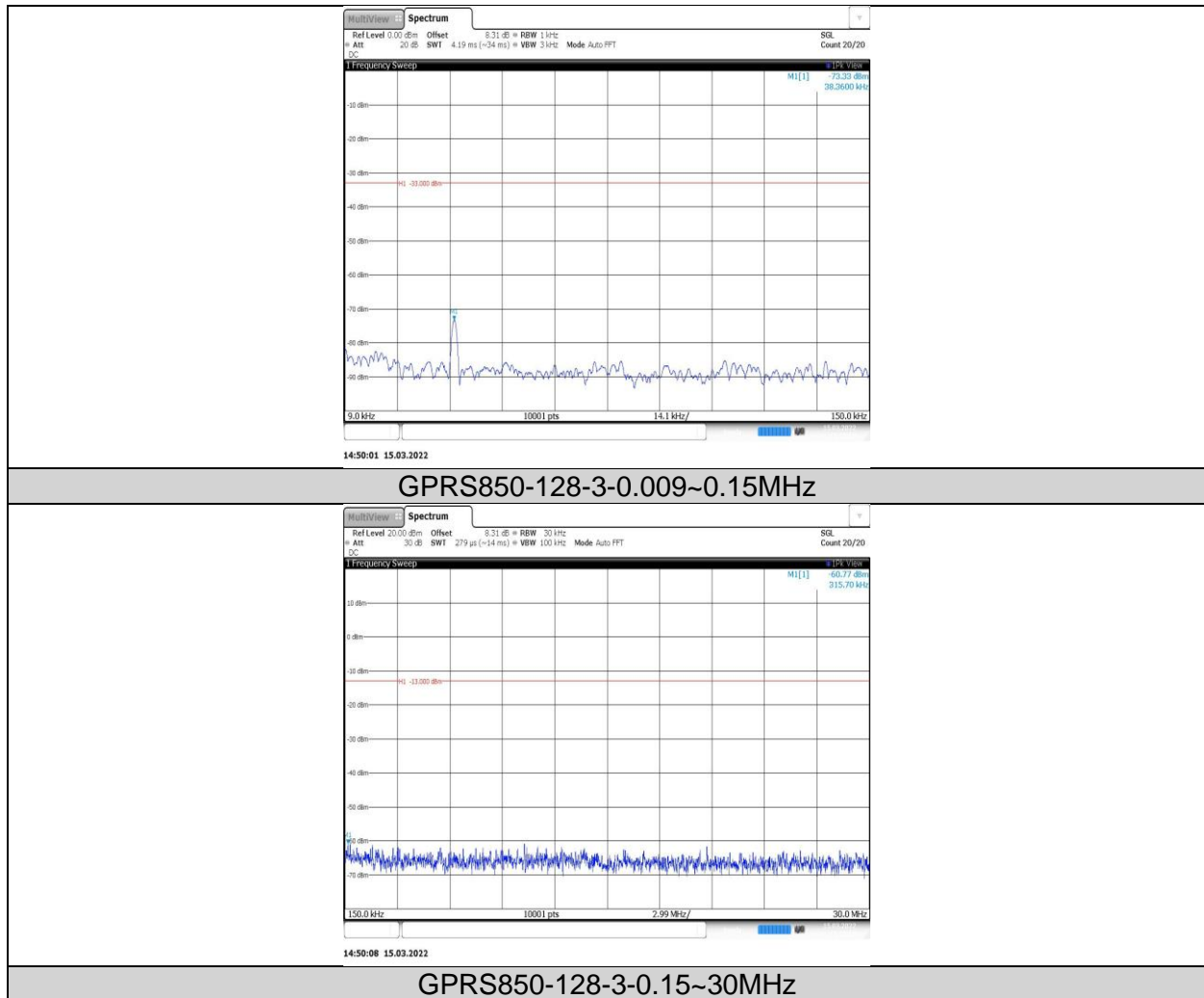

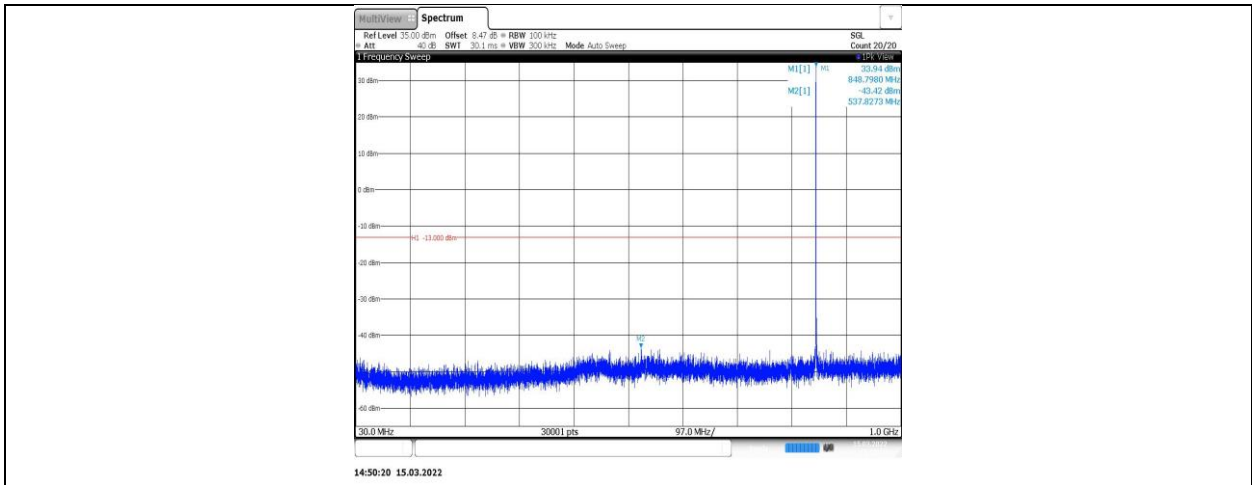

GPRS850-128-3-30~1000MHz

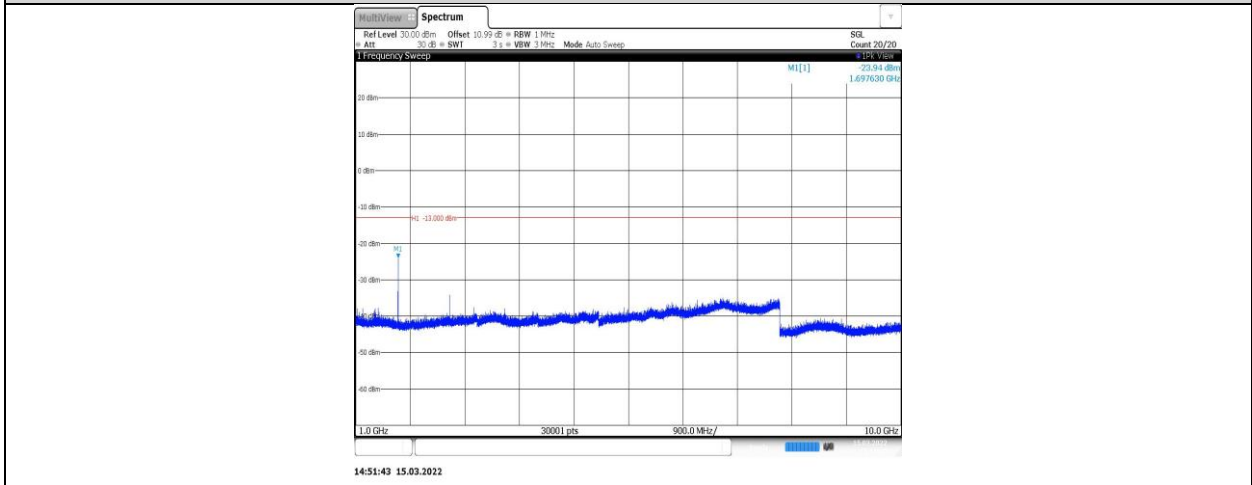

GPRS850-128-3-1000~10000MHz

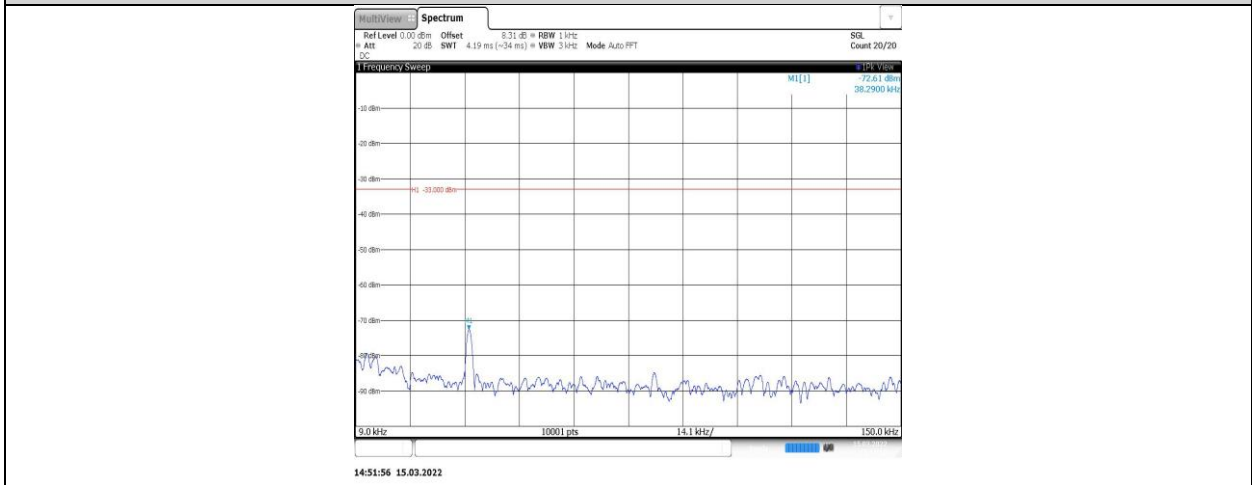

GPRS850-190-3-0.009~0.15MHz

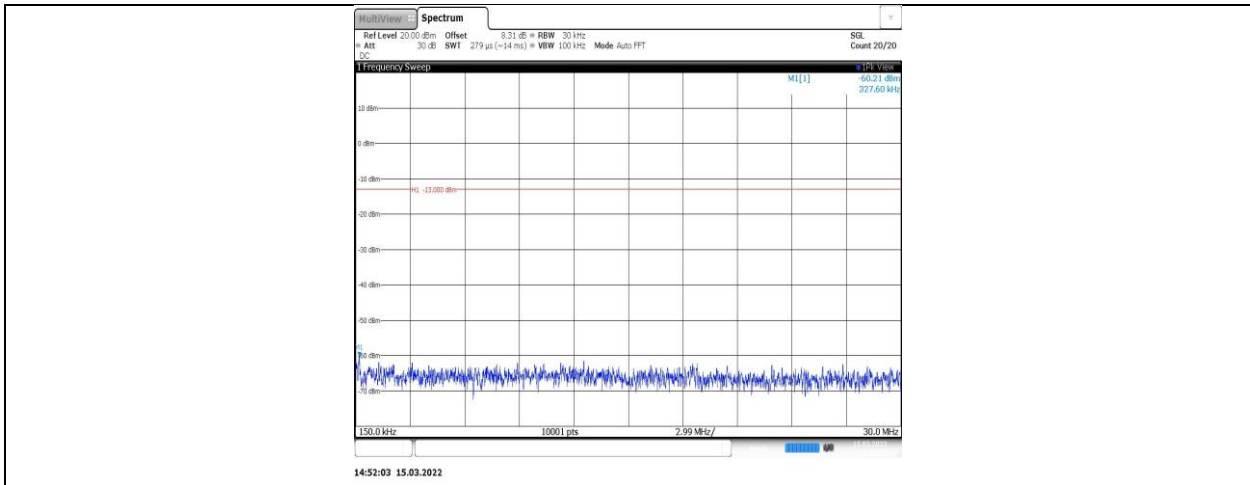

GPRS850-190-3-0.15~30MHz

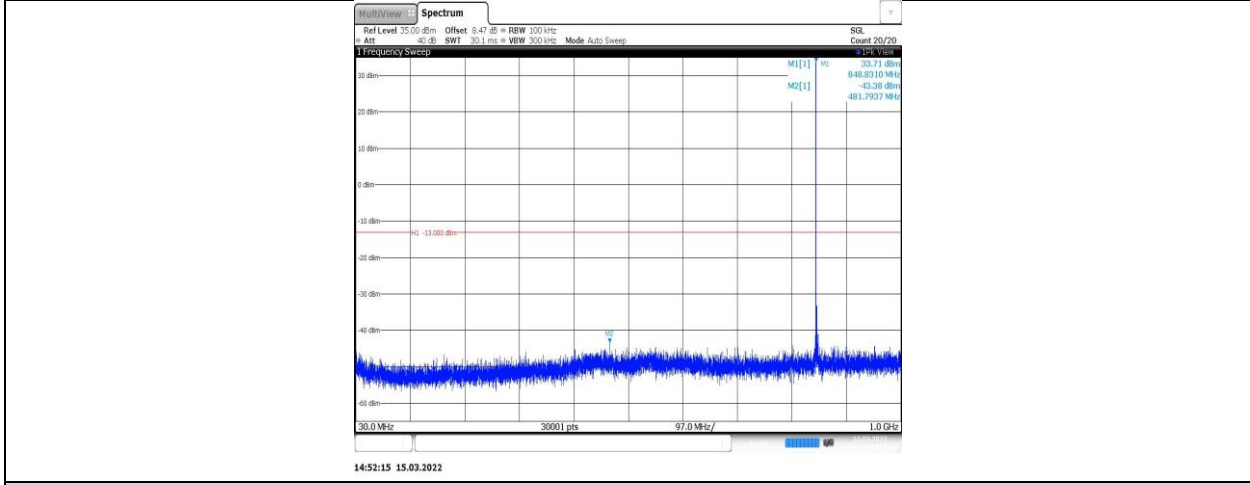

GPRS850-190-3-30~1000MHz

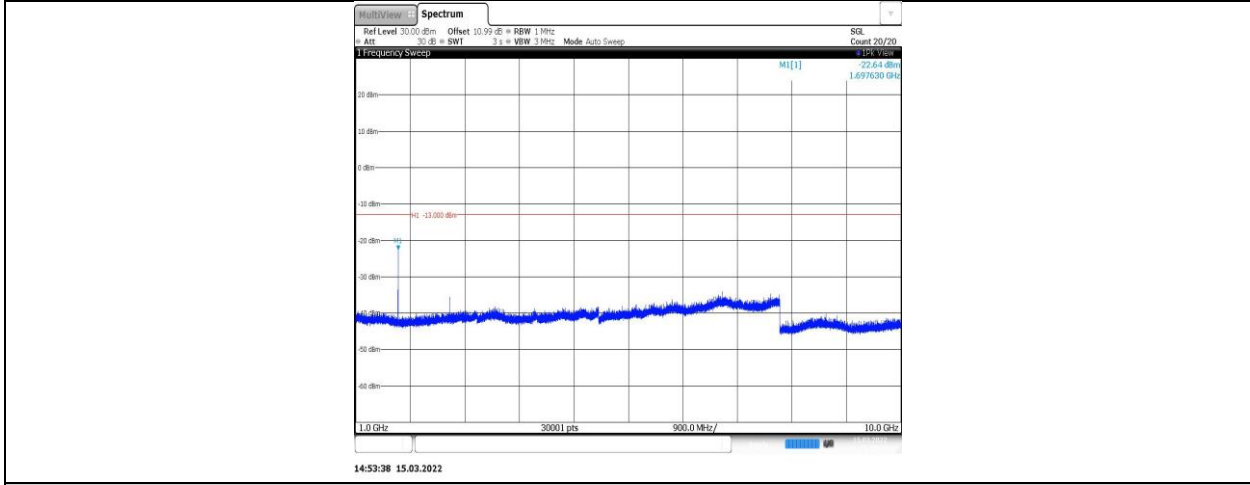

GPRS850-190-3-1000~10000MHz

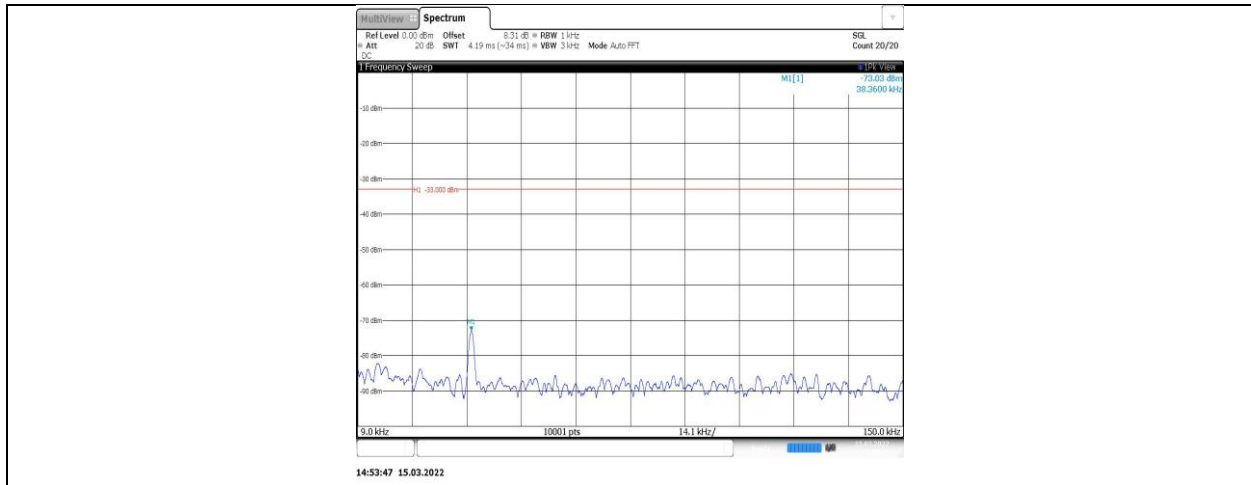

GPRS850-251-3-0.009~0.15MHz

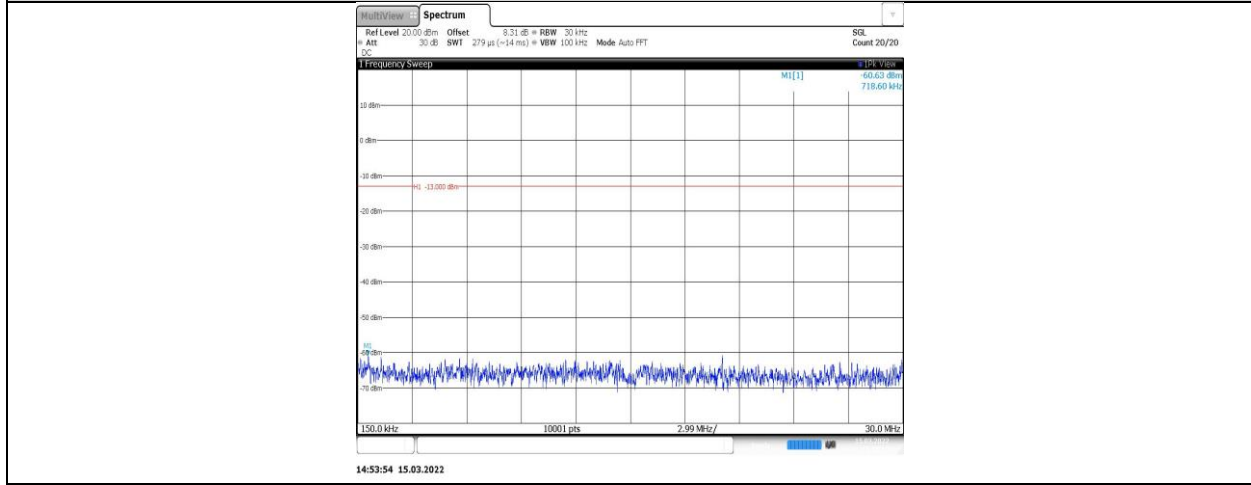

GPRS850-251-3-0.15~30MHz

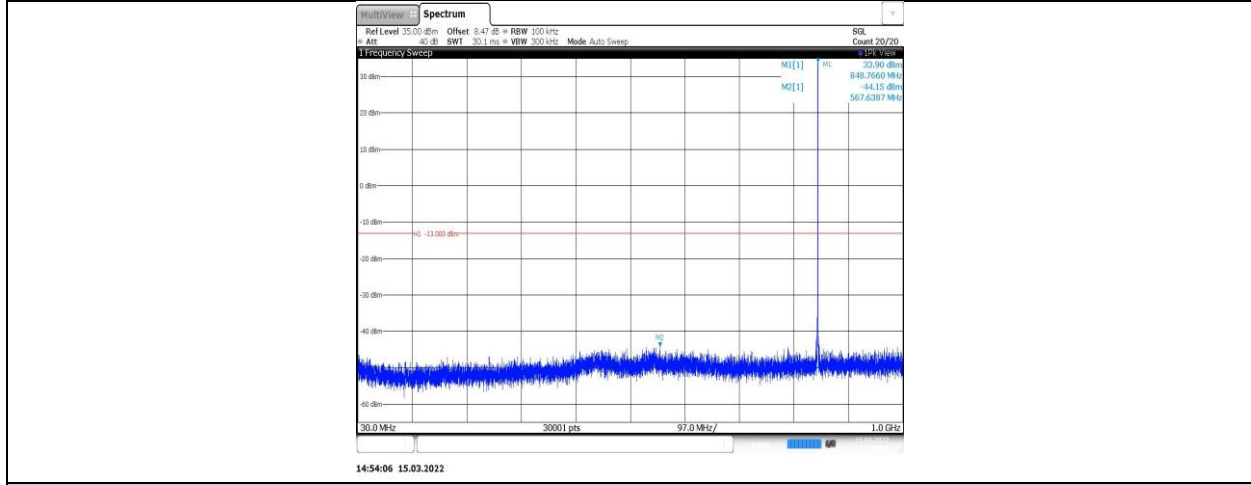

GPRS850-251-3-30~1000MHz

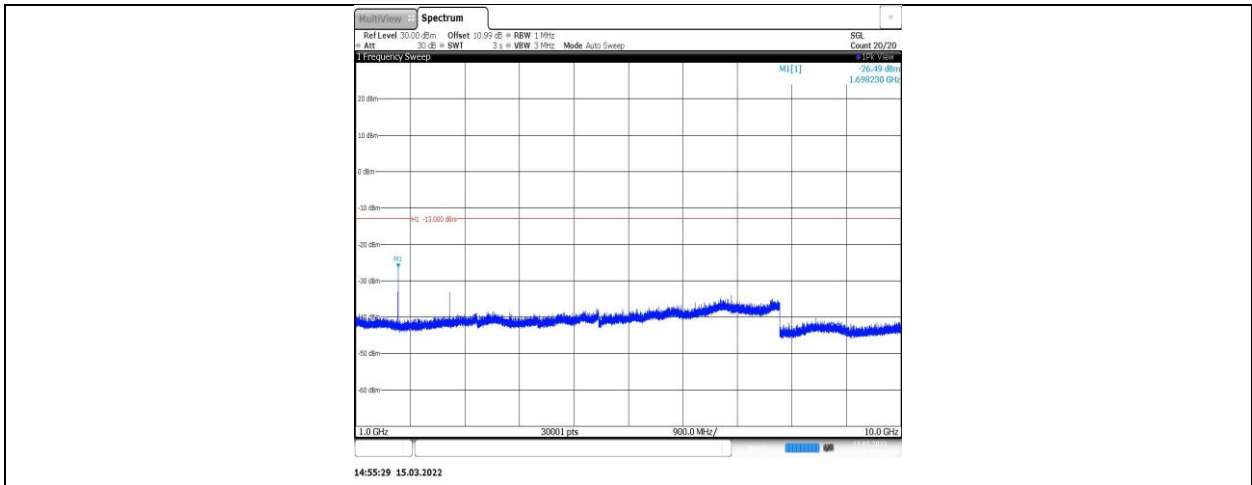

GPRS850-251-3-1000~10000MHz

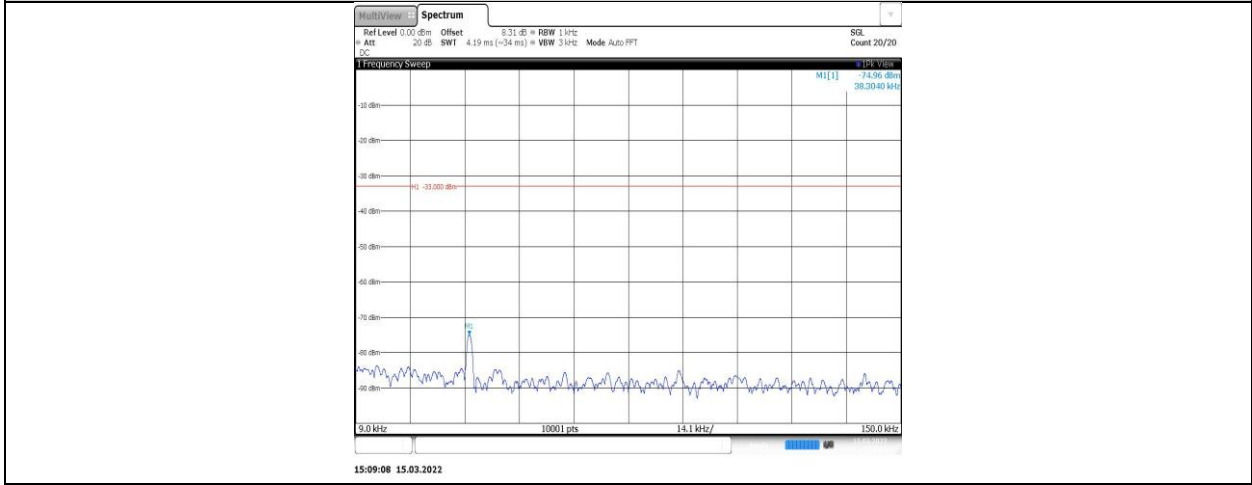

EGPRS850-128-8-0.009~0.15MHz

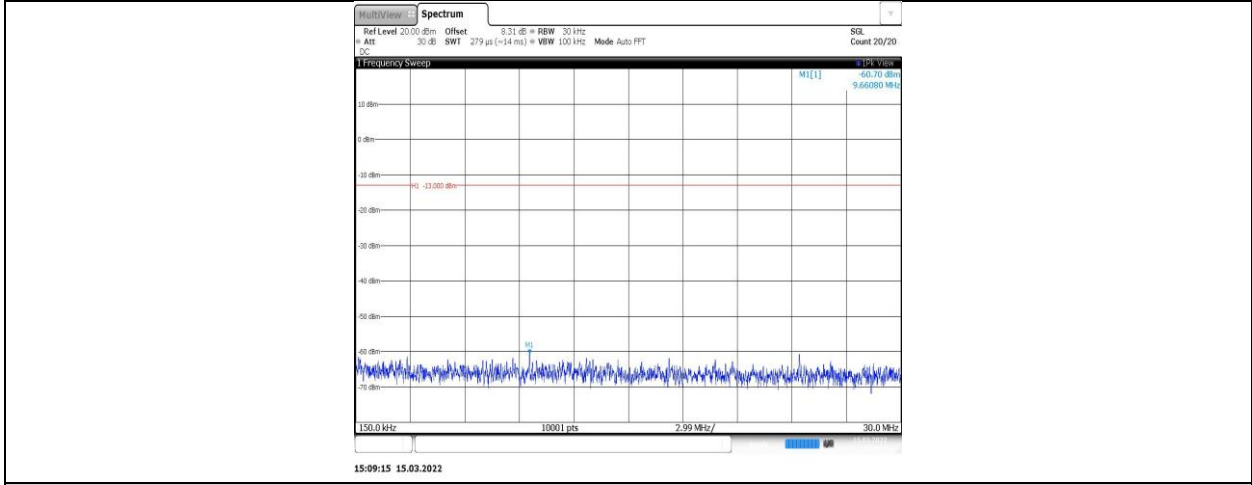

EGPRS850-128-8-0.15~30MHz

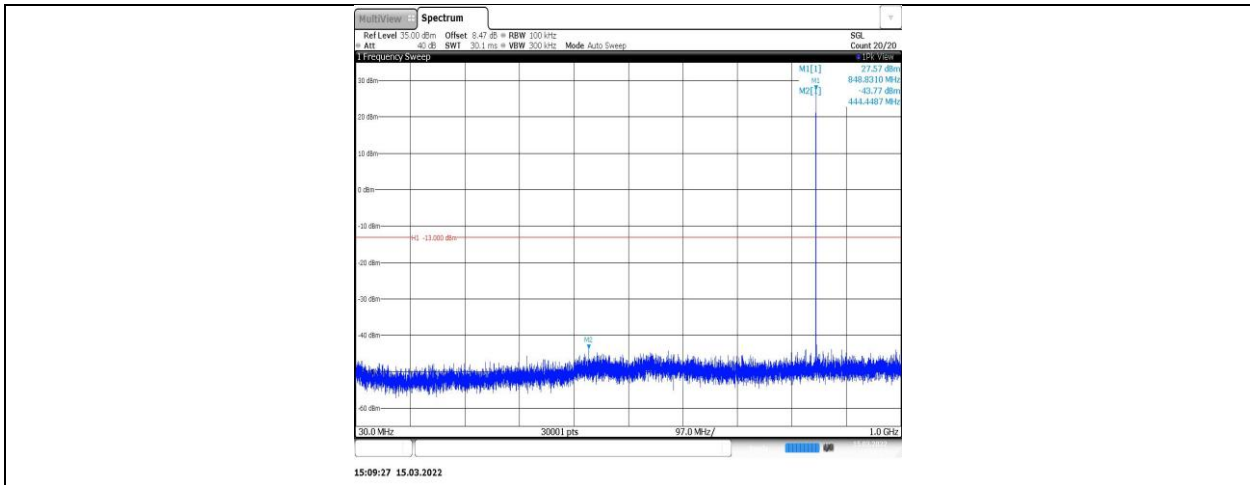

EGPRS850-128-8-30~1000MHz

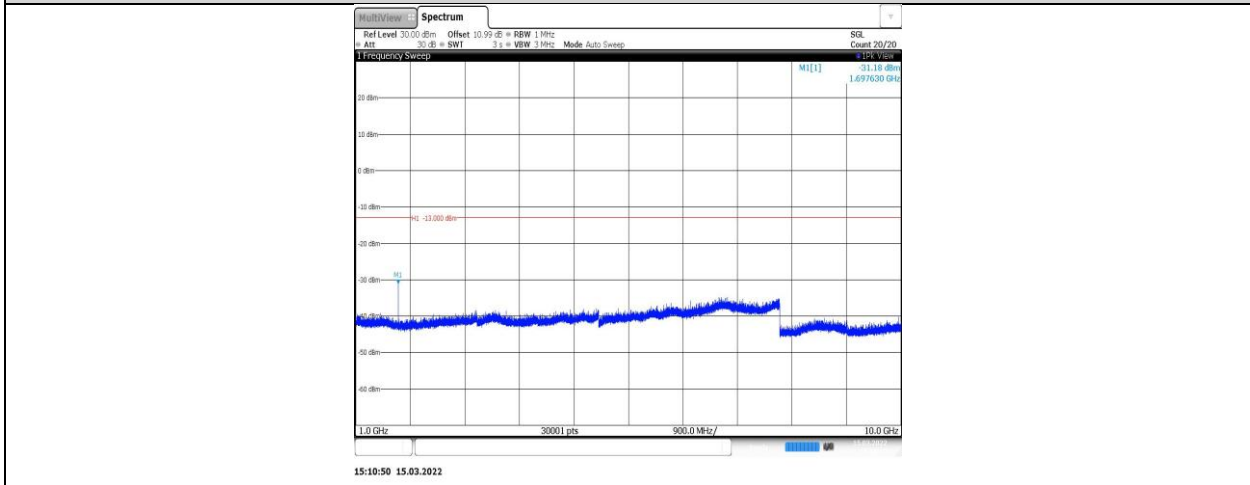

EGPRS850-128-8-1000~10000MHz

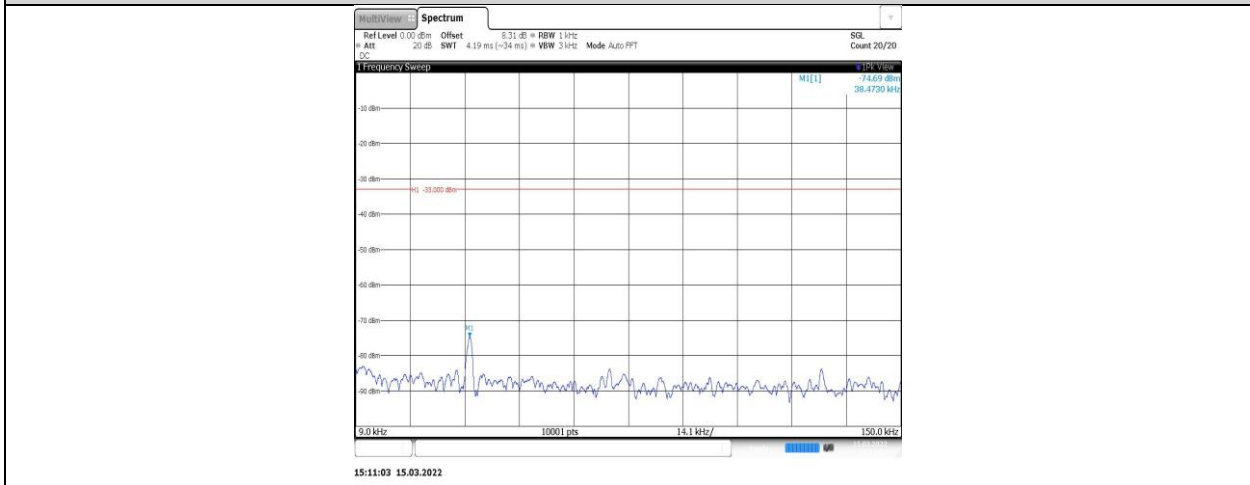

EGPRS850-190-8-0.009~0.15MHz

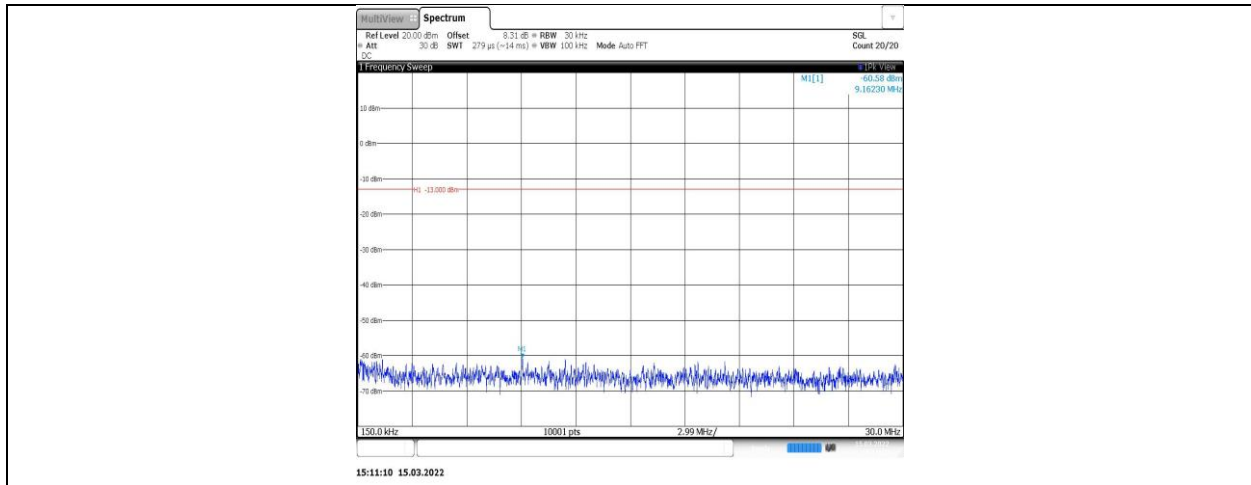

EGPRS850-190-8-0.15~30MHz

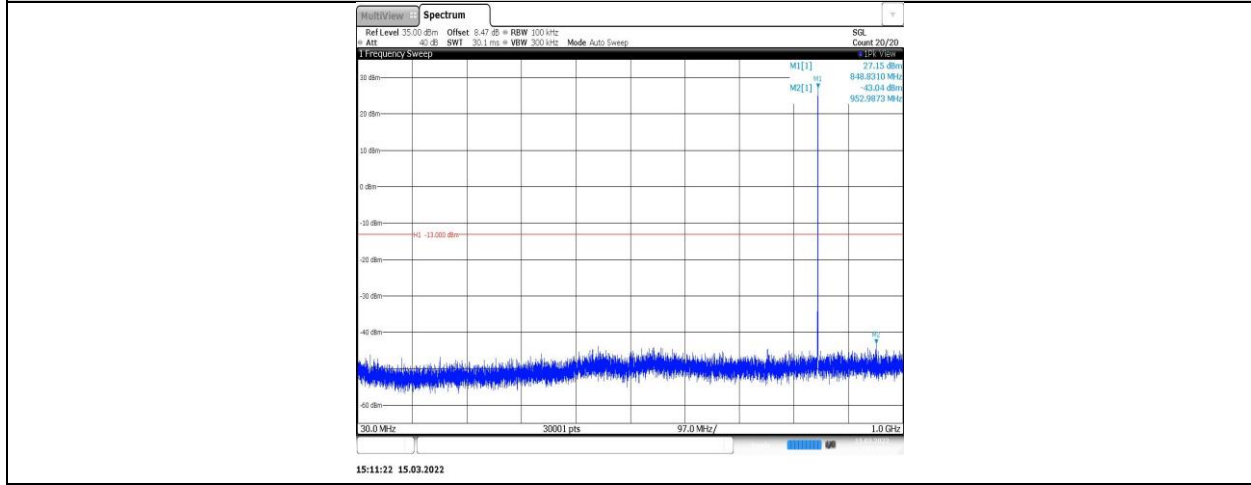

EGPRS850-190-8-30~1000MHz

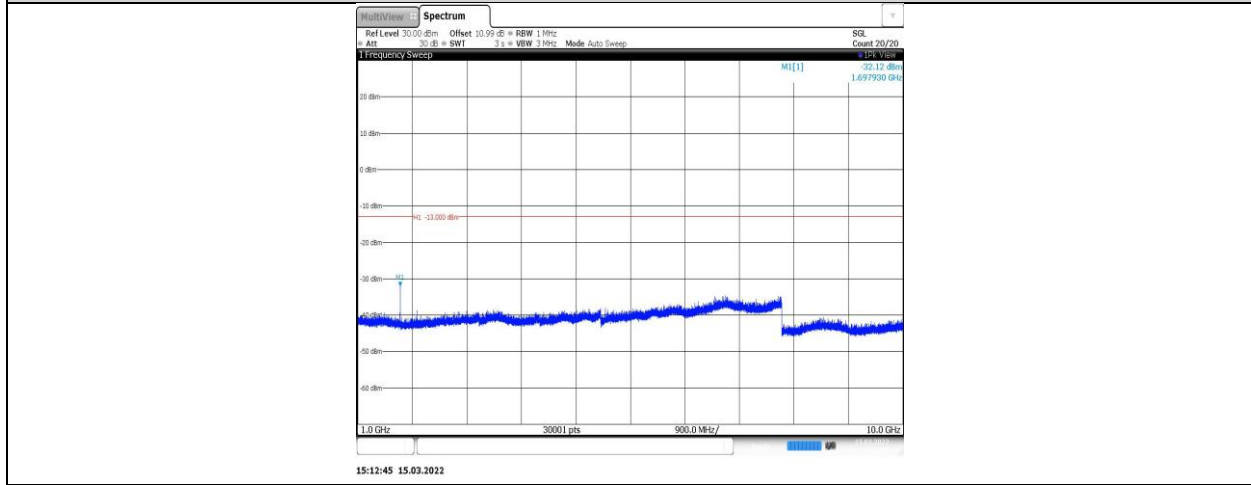

EGPRS850-190-8-1000~10000MHz

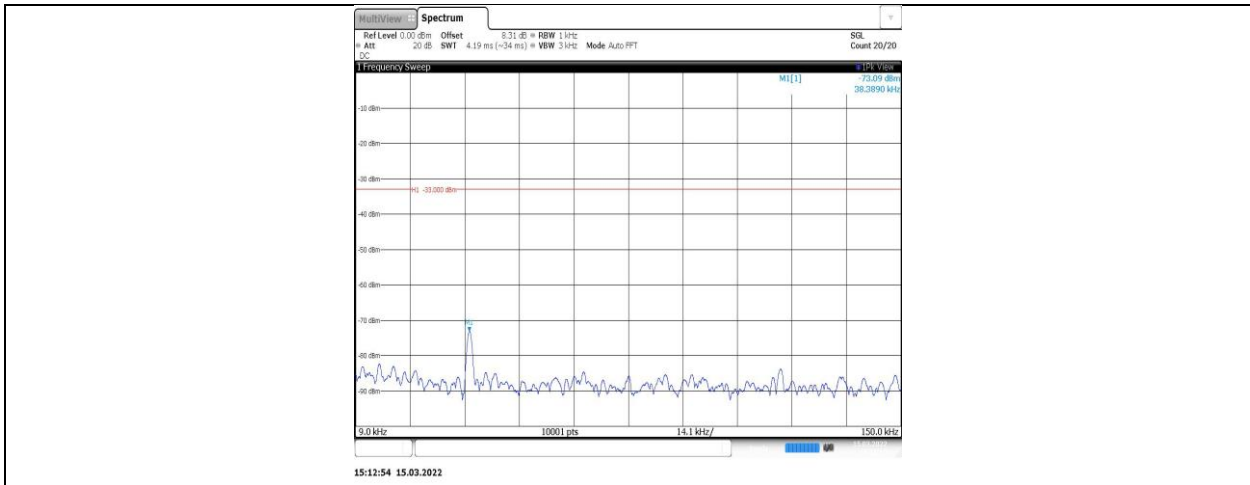

EGPRS850-251-8-0.009~0.15MHz

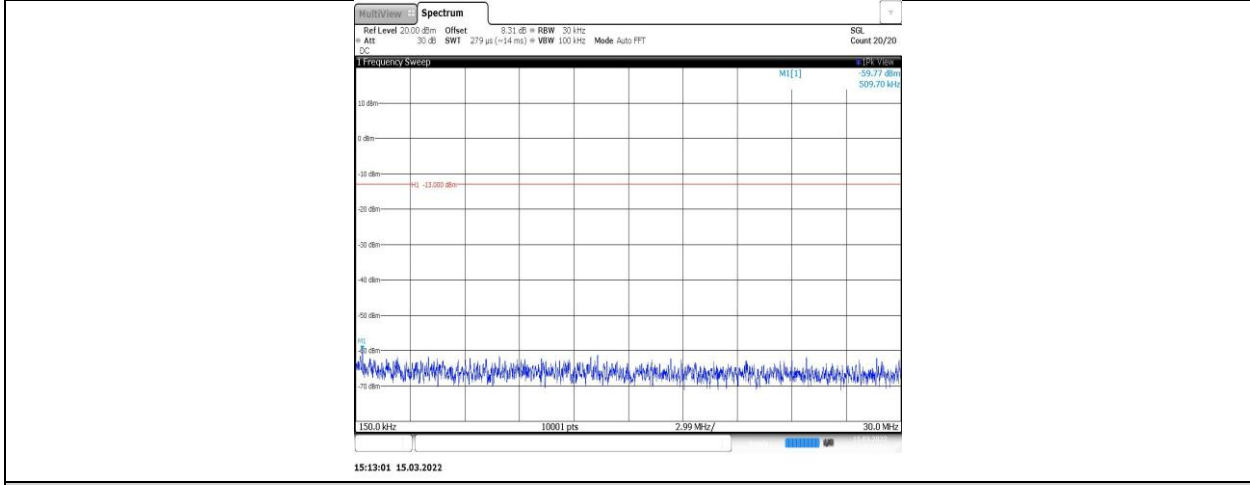

EGPRS850-251-8-0.15~30MHz

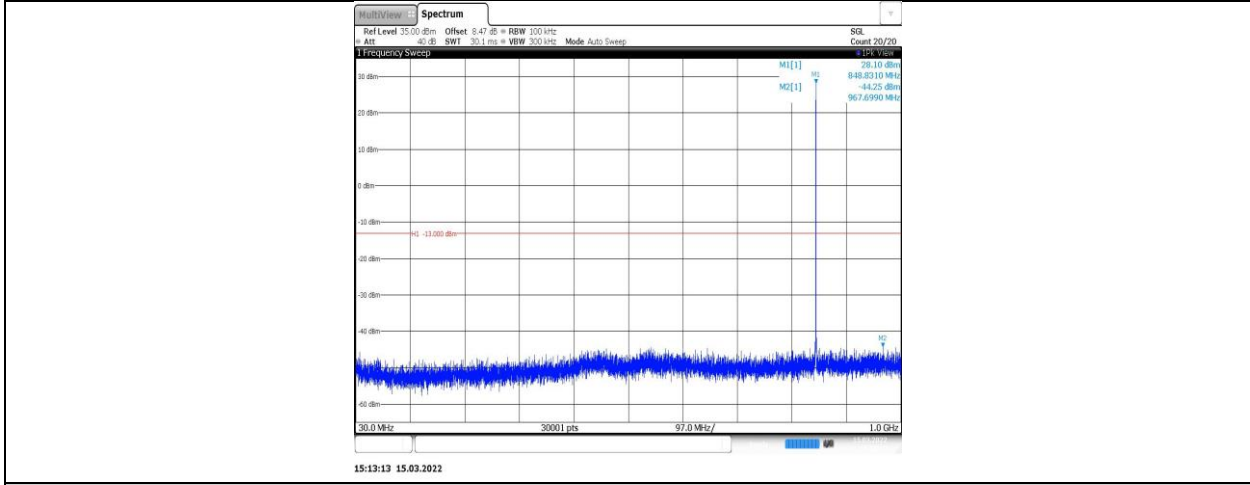

EGPRS850-251-8-30~1000MHz

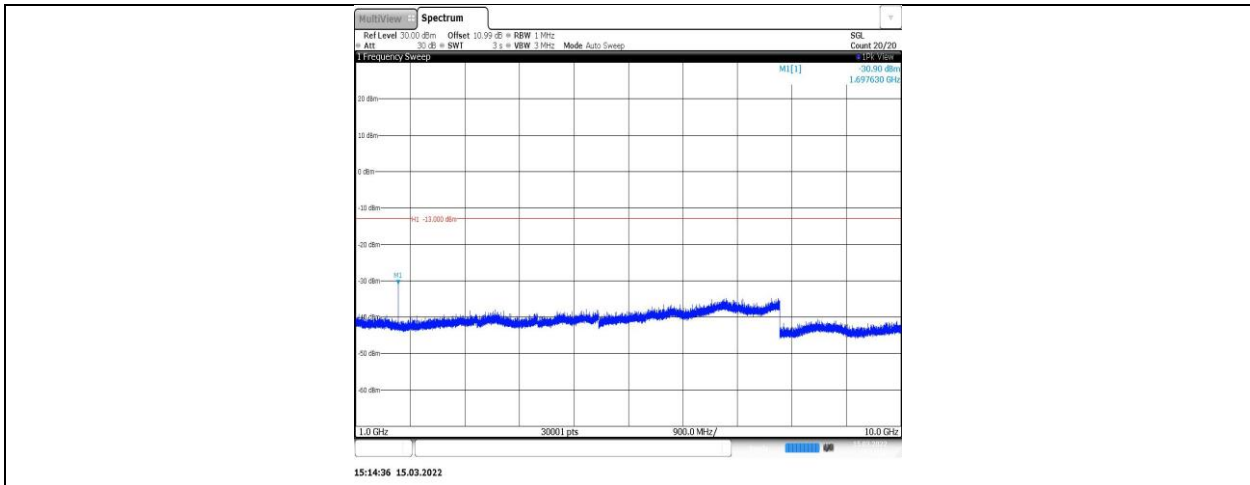

EGPRS850-251-8-1000~10000MHz

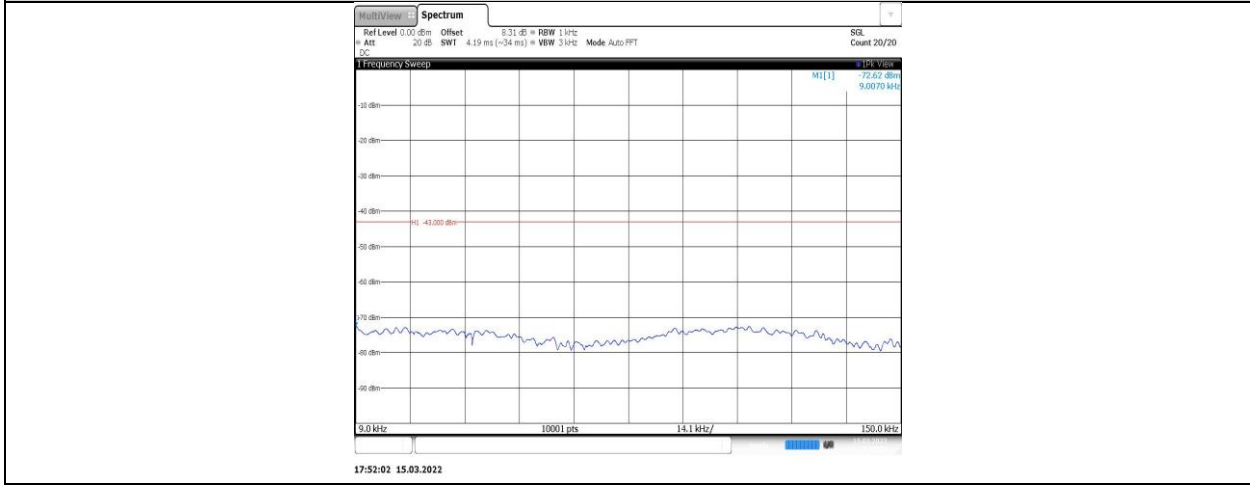

GPRS1900-512-0-0.009~0.15MHz

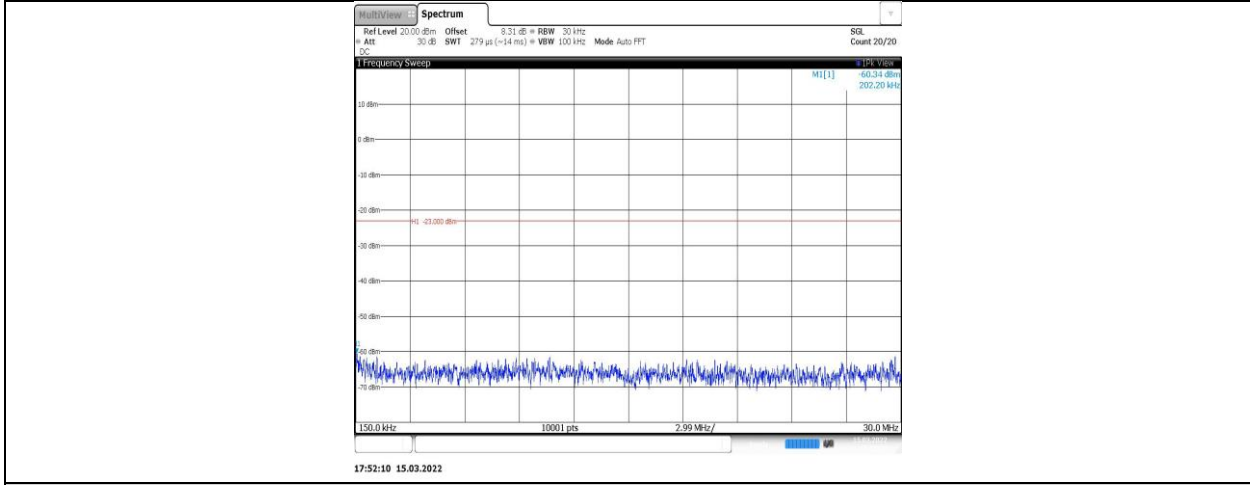

GPRS1900-512-0-0.15~30MHz

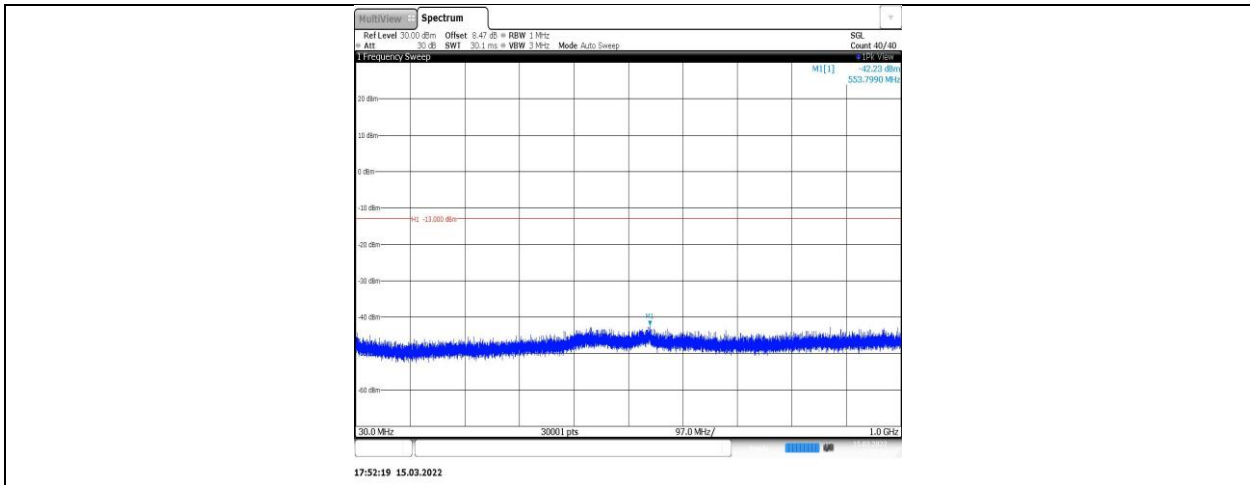

GPRS1900-512-0-30~1000MHz

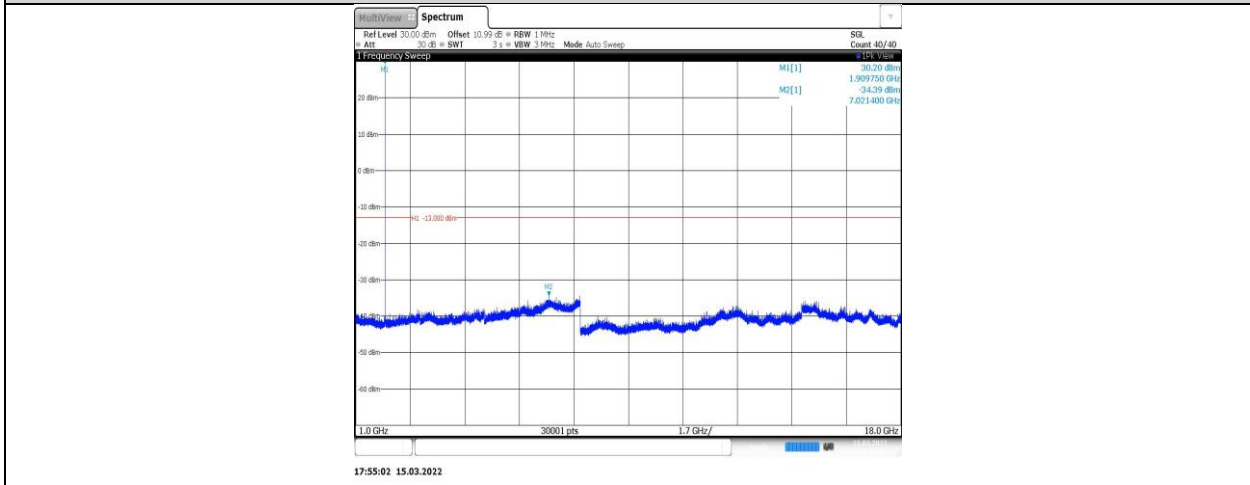

GPRS1900-512-0-1000~18000MHz

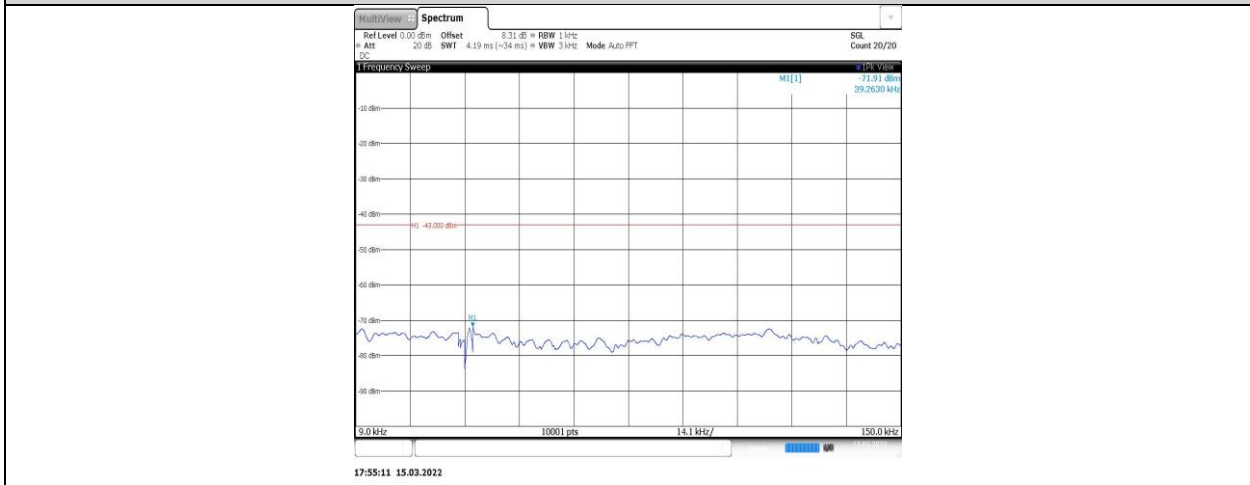

GPRS1900-661-0-0.009~0.15MHz

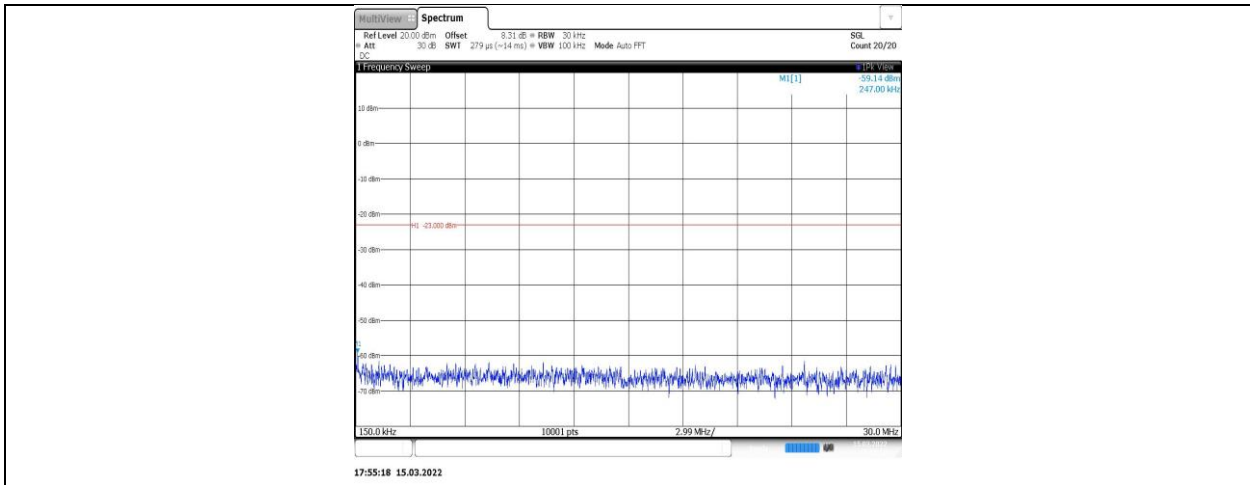

GPRS1900-661-0-0.15~30MHz

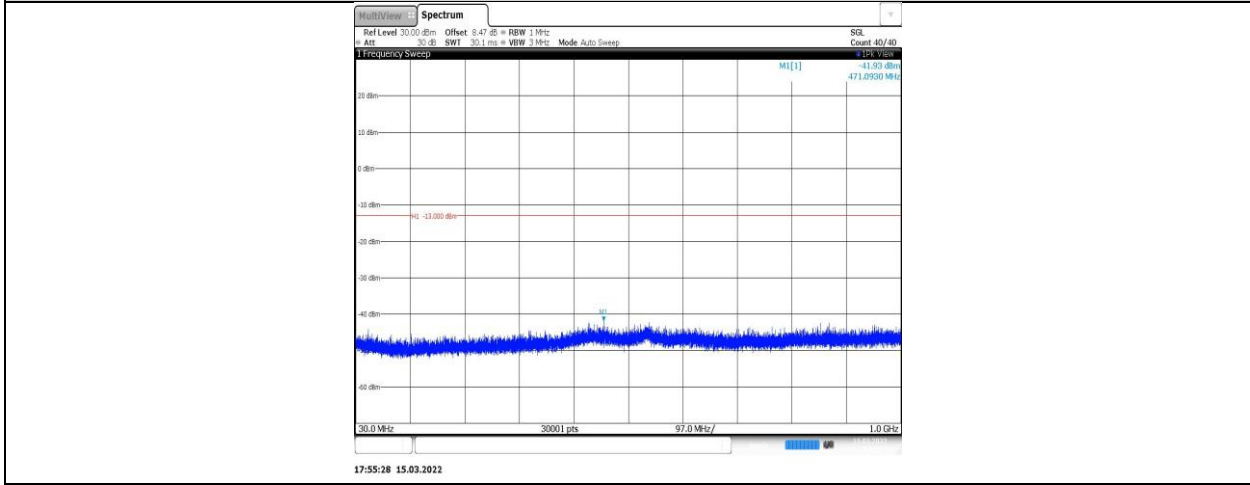

GPRS1900-661-0-30~1000MHz

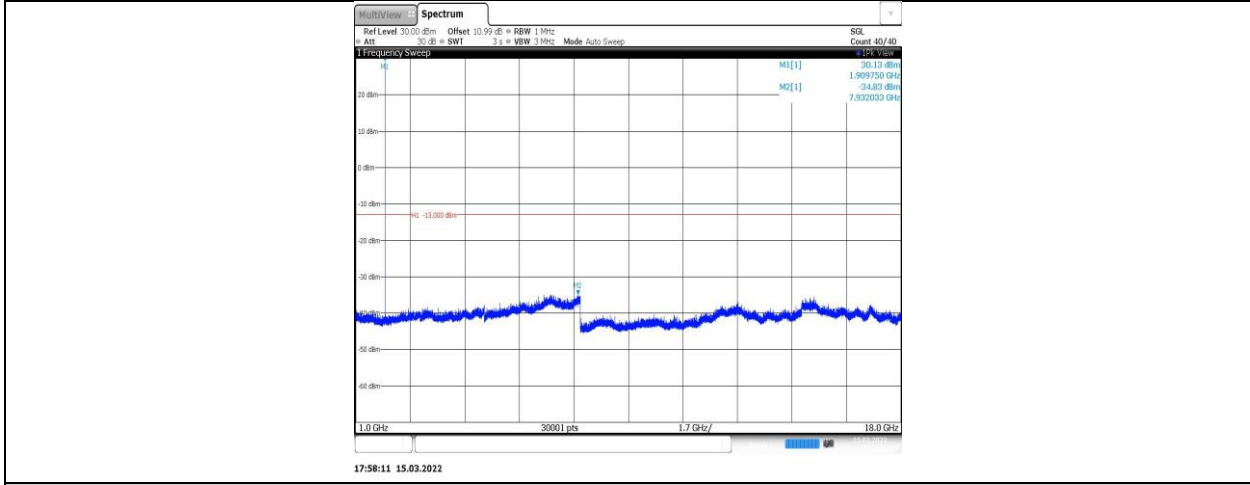

GPRS1900-661-0-1000~18000MHz

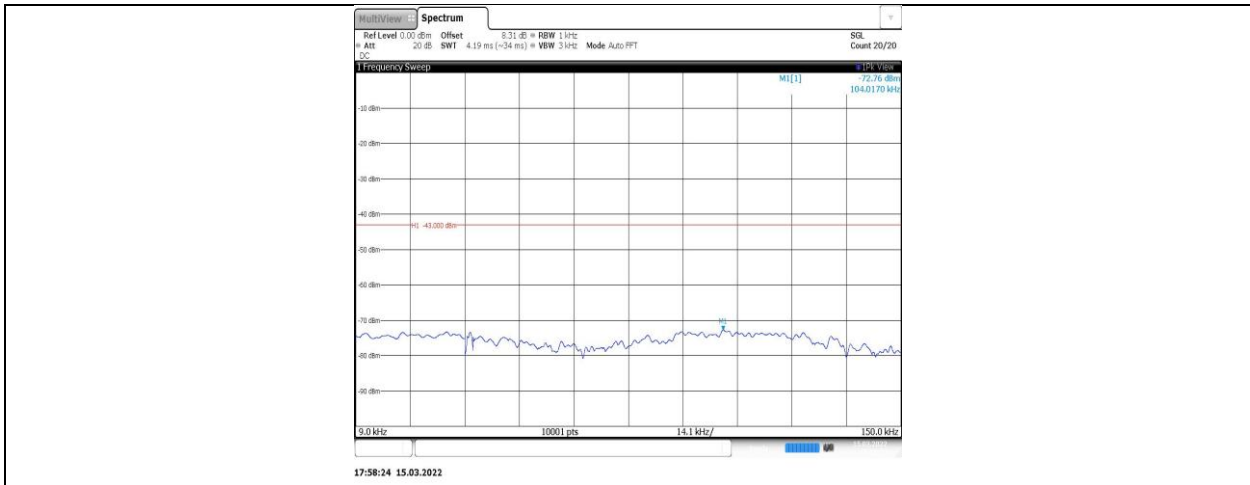

GPRS1900-810-0-0.009~0.15MHz

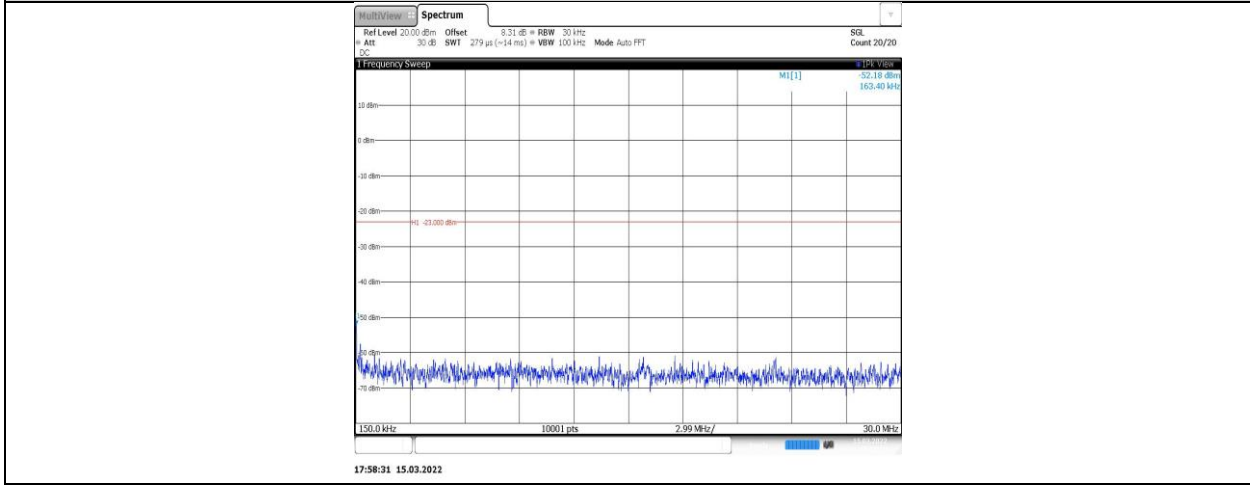

GPRS1900-810-0-0.15~30MHz

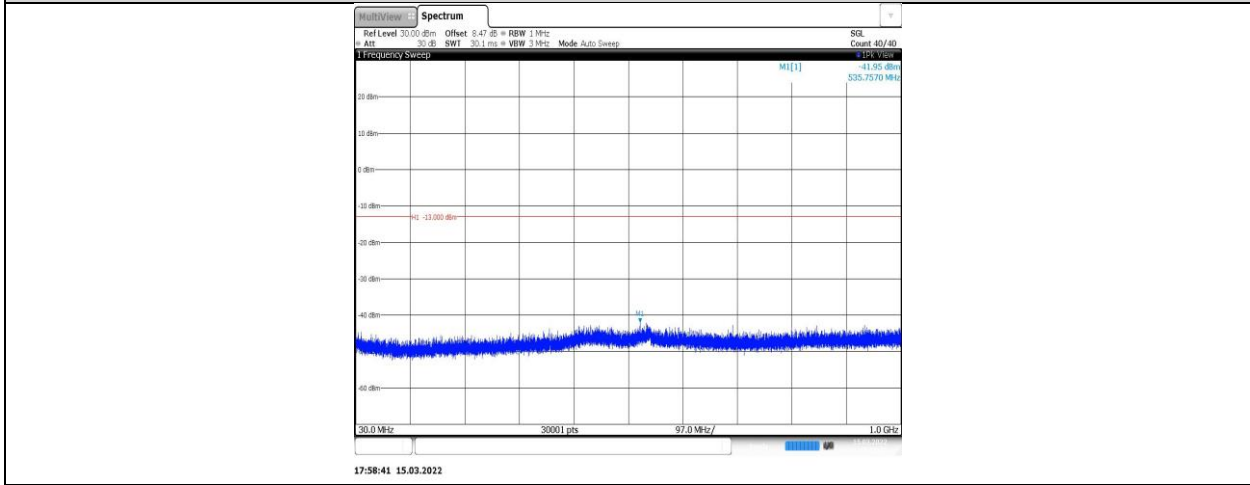

GPRS1900-810-0-30~1000MHz

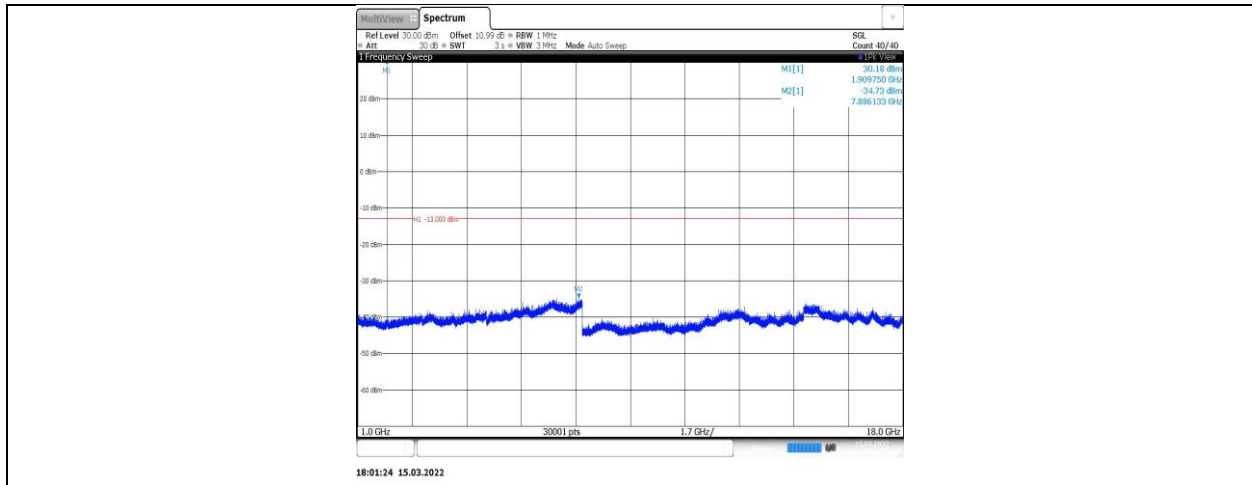

GPRS1900-810-0-1000~18000MHz

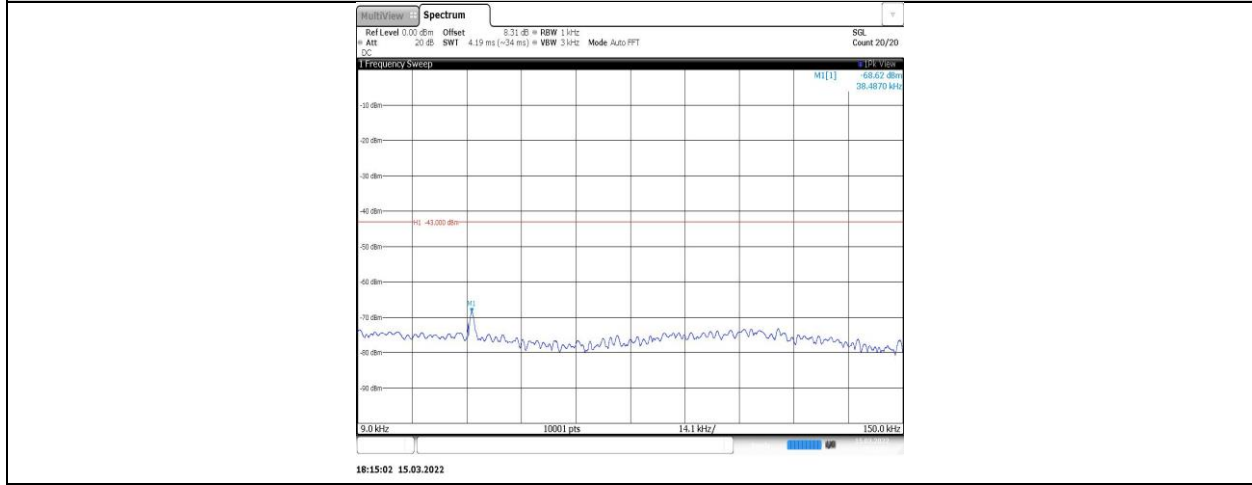

EGPRS1900-512-2-0.009~0.15MHz

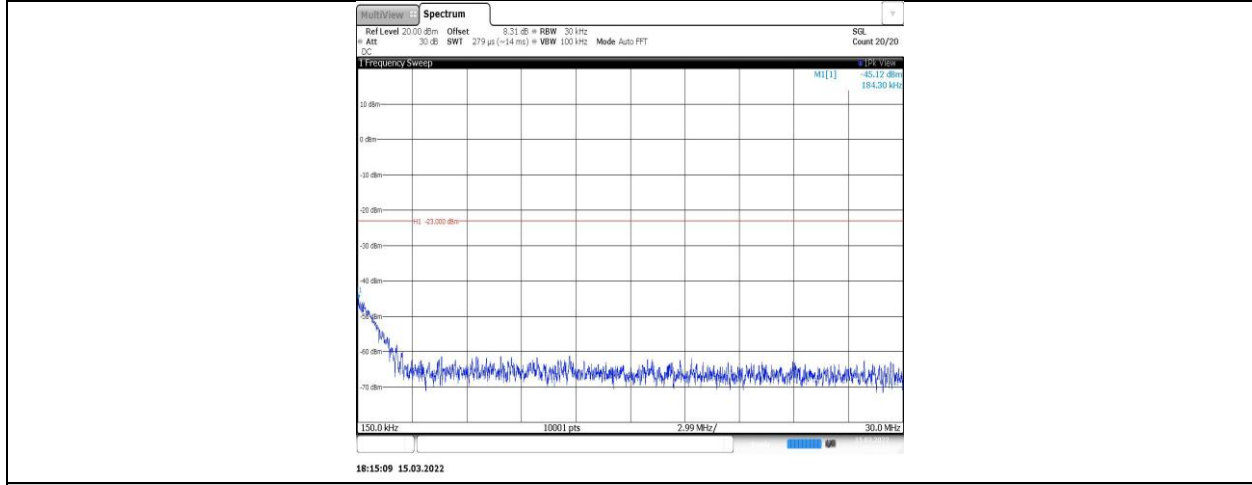

EGPRS1900-512-2-0.15~30MHz

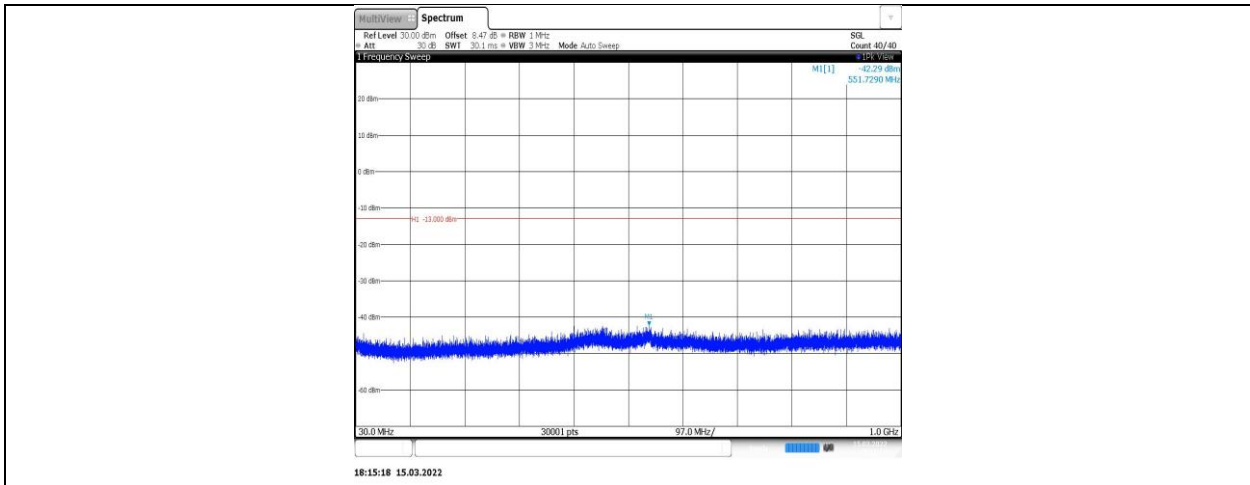

EGPRS1900-512-2-30~1000MHz

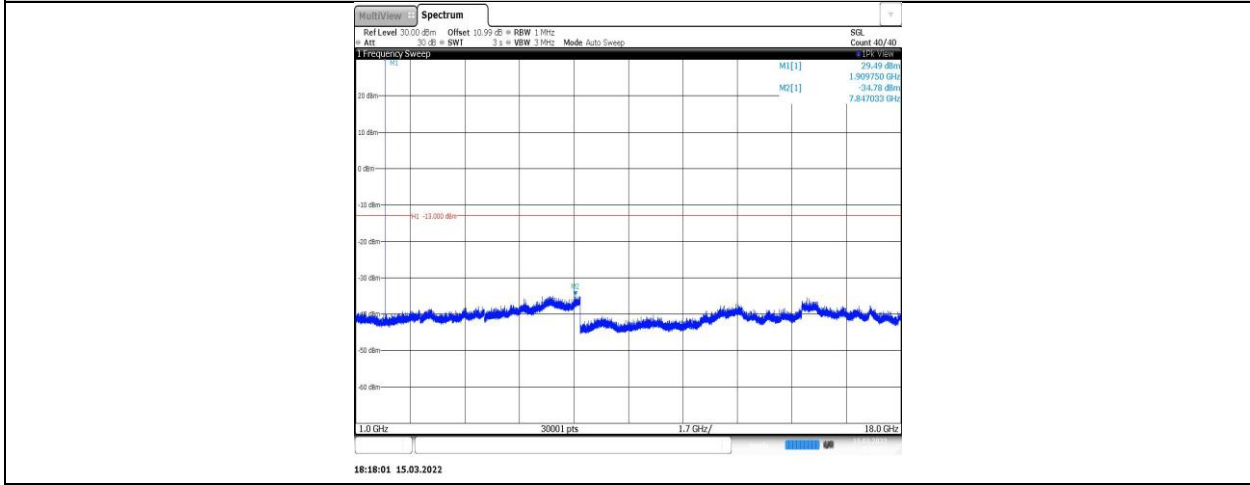

EGPRS1900-512-2-1000~18000MHz

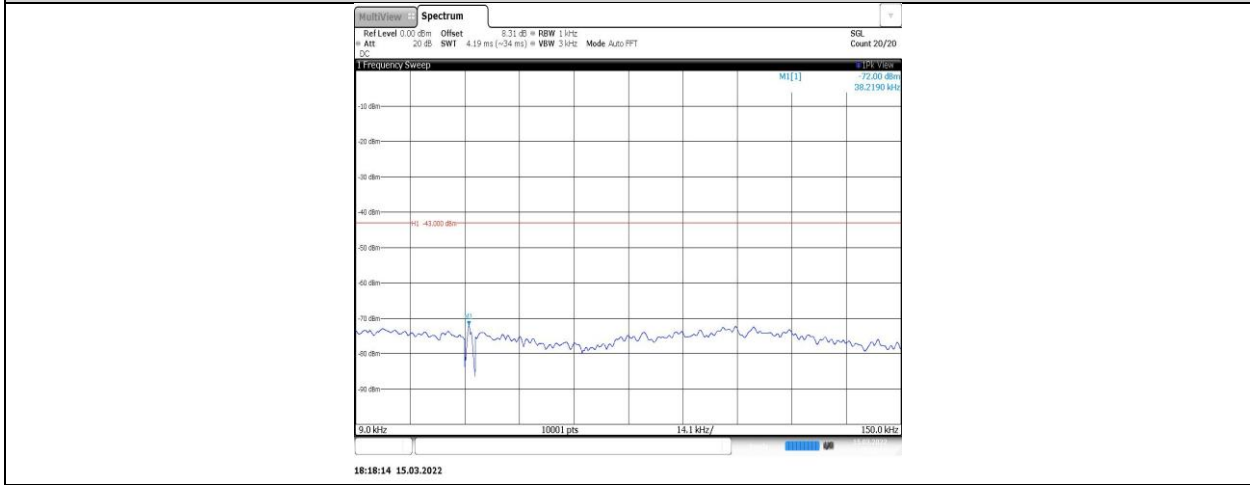

EGPRS1900-661-2-0.009~0.15MHz

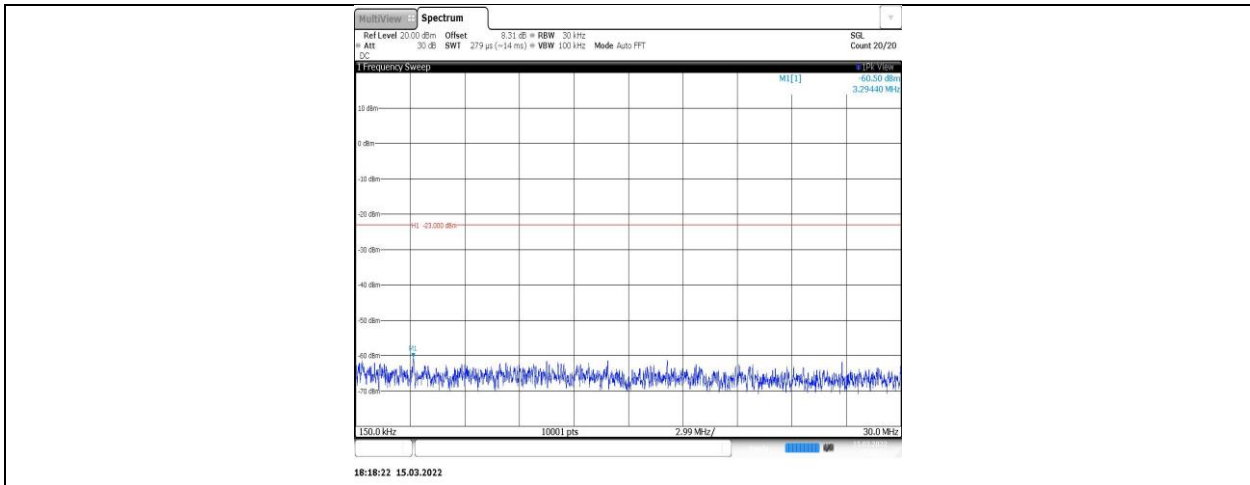

EGPRS1900-661-2-0.15~30MHz

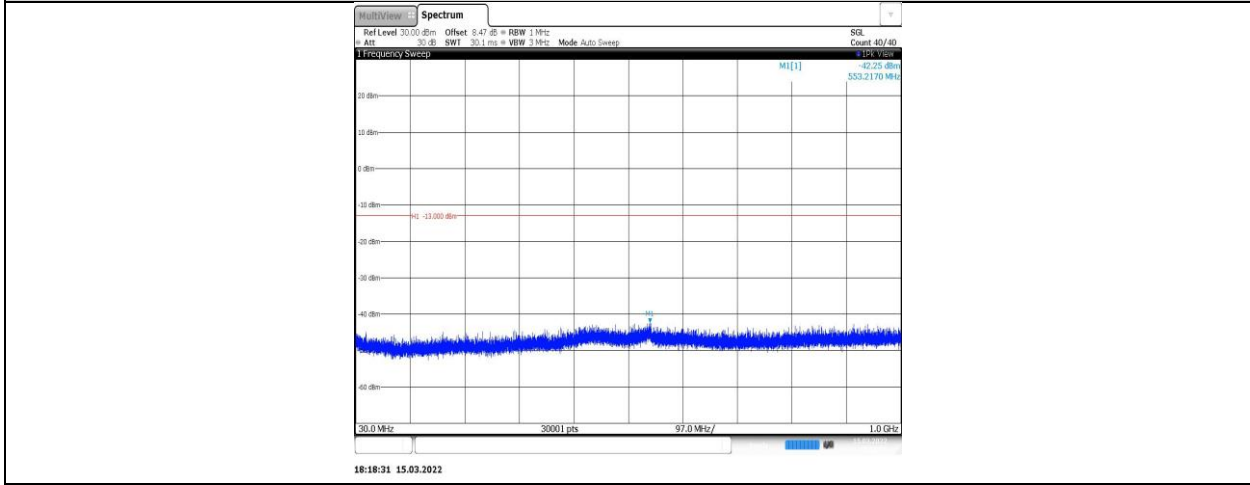

EGPRS1900-661-2-30~1000MHz

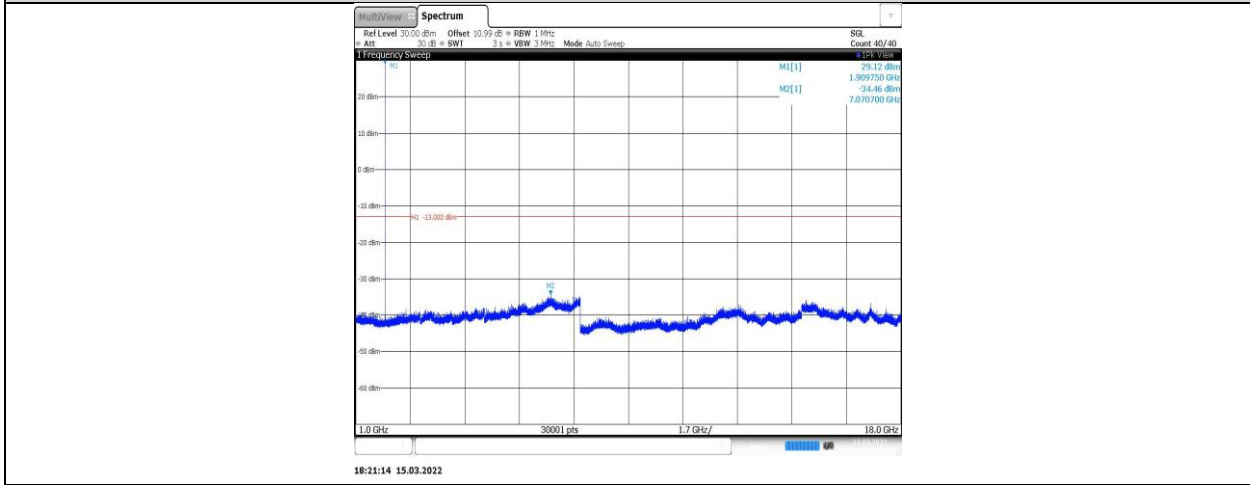

EGPRS1900-661-2-1000~18000MHz

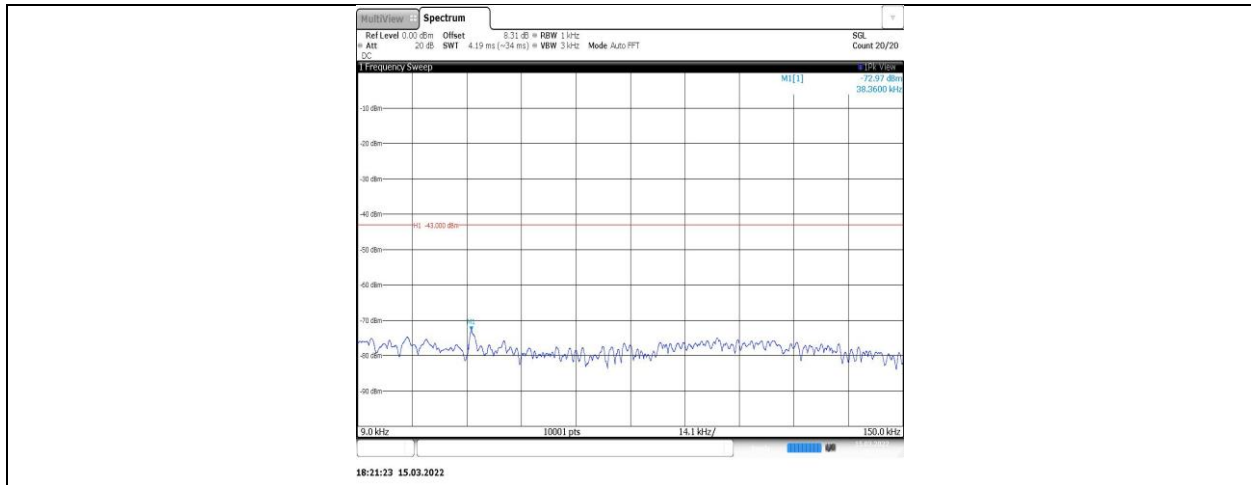

EGPRS1900-810-2-0.009~0.15MHz

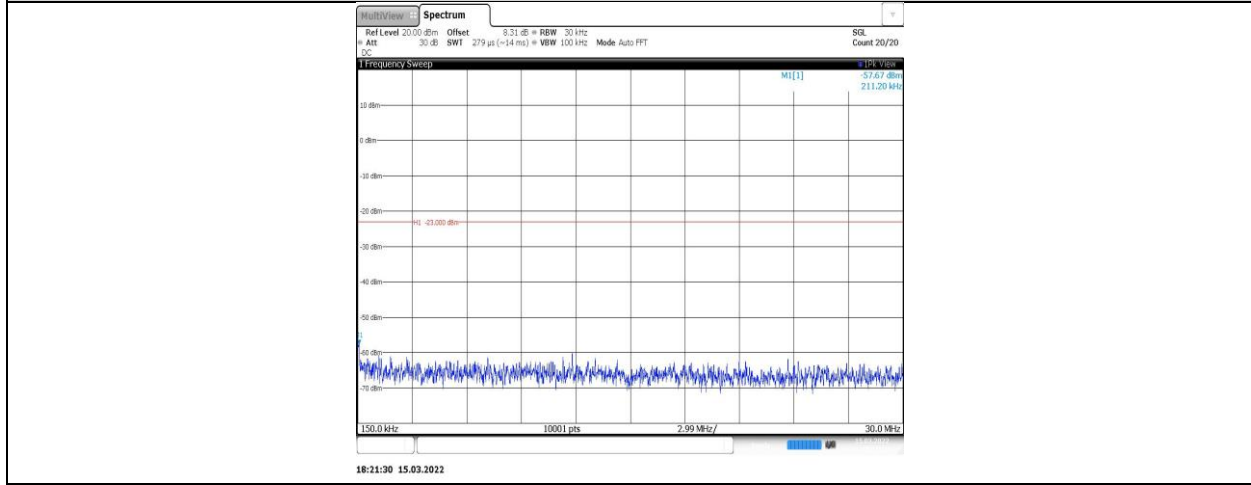

EGPRS1900-810-2-0.15~30MHz

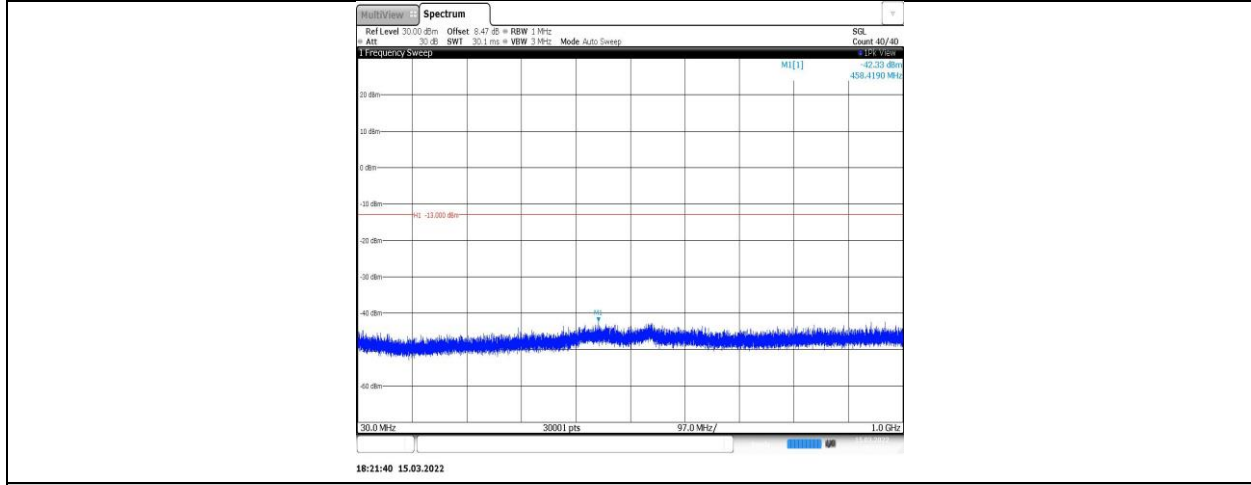

EGPRS1900-810-2-30~1000MHz

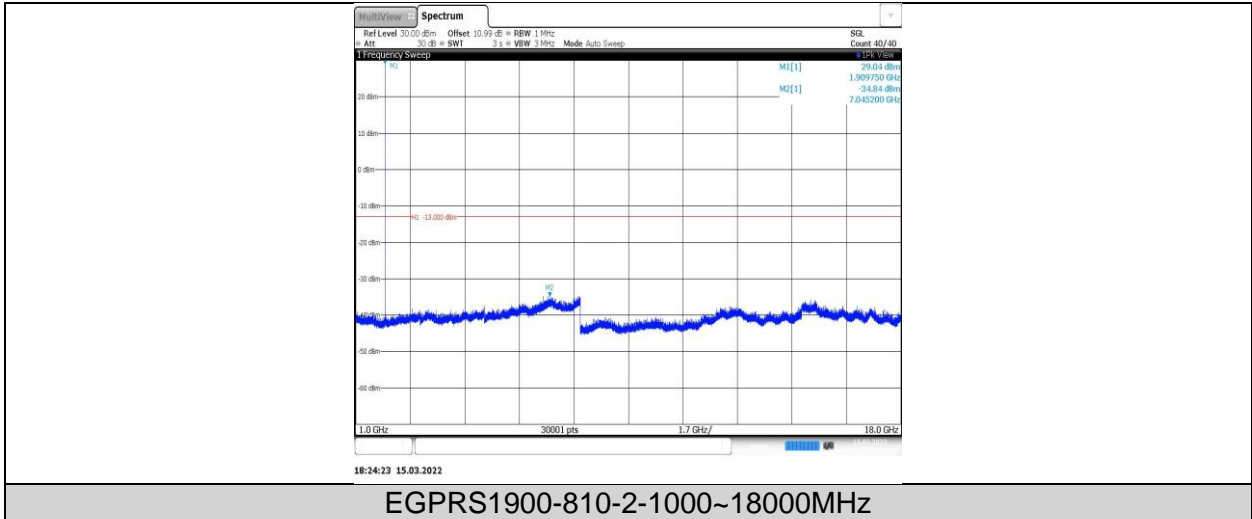



WCDMA

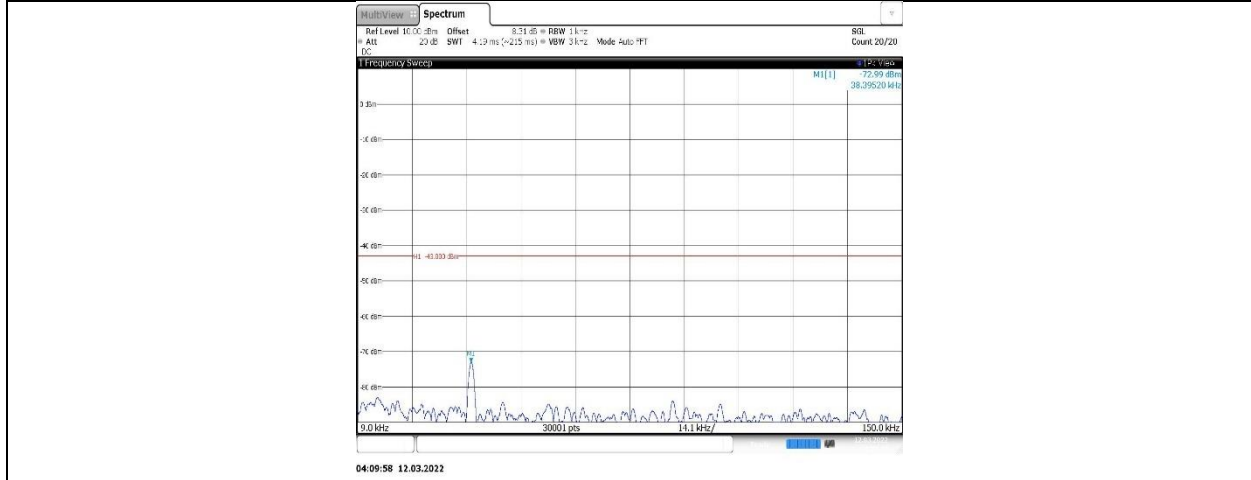

Band2-9262-0.009~0.15MHz

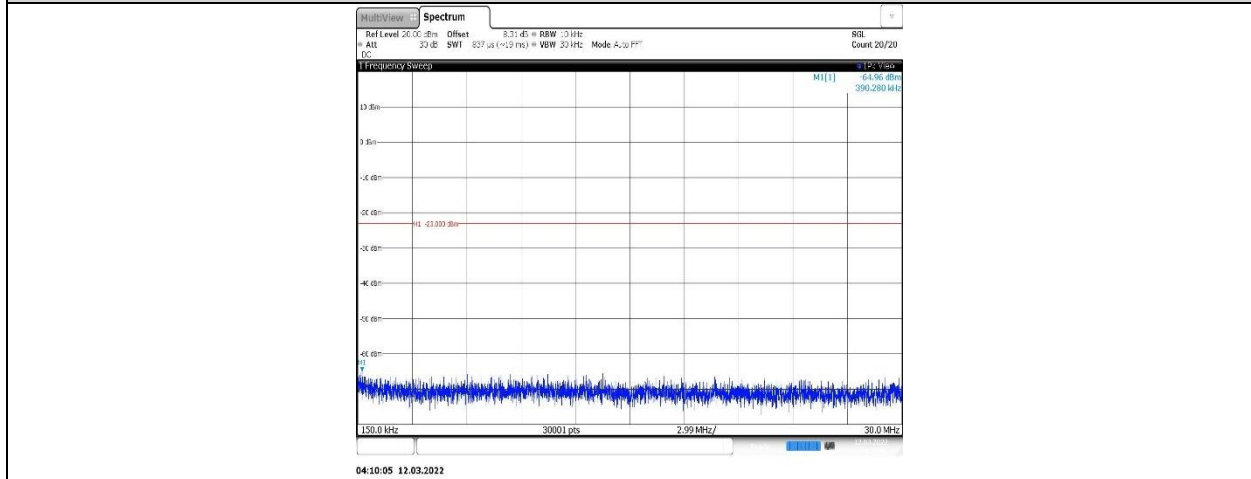

Band2-9262-0.15~30MHz

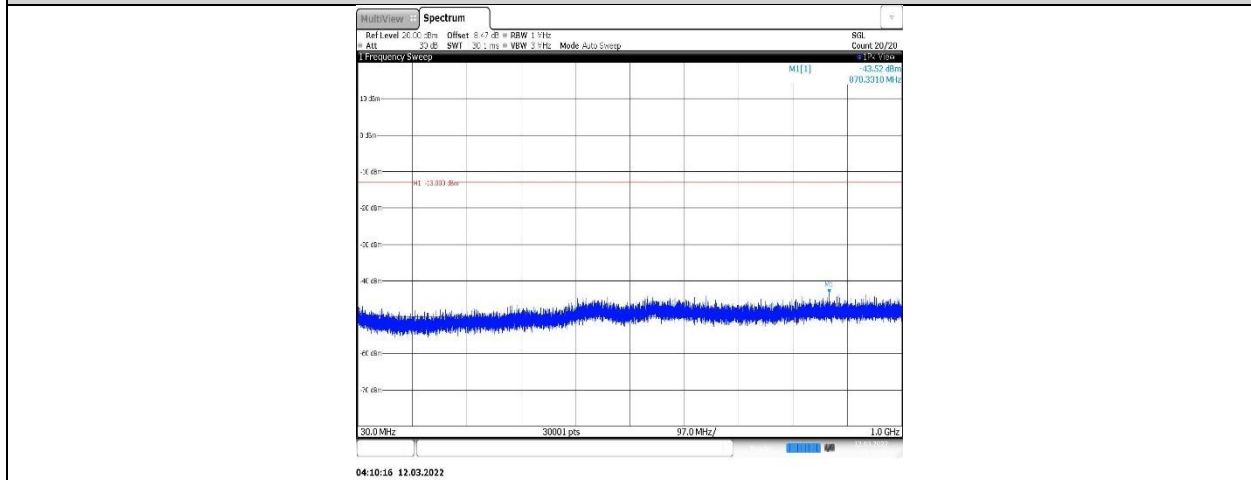

Band2-9262-30~1000MHz

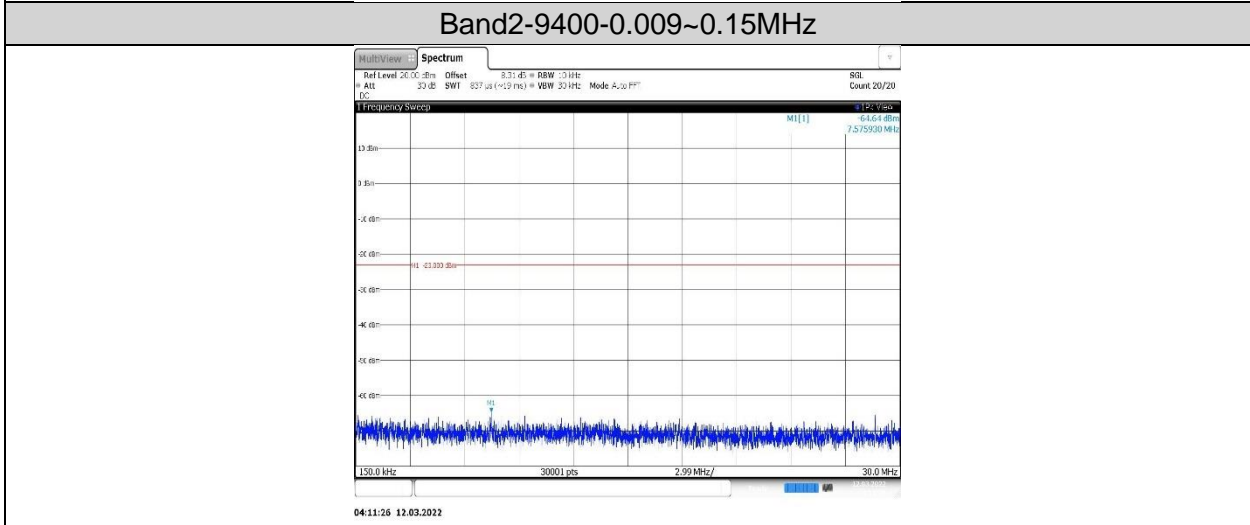
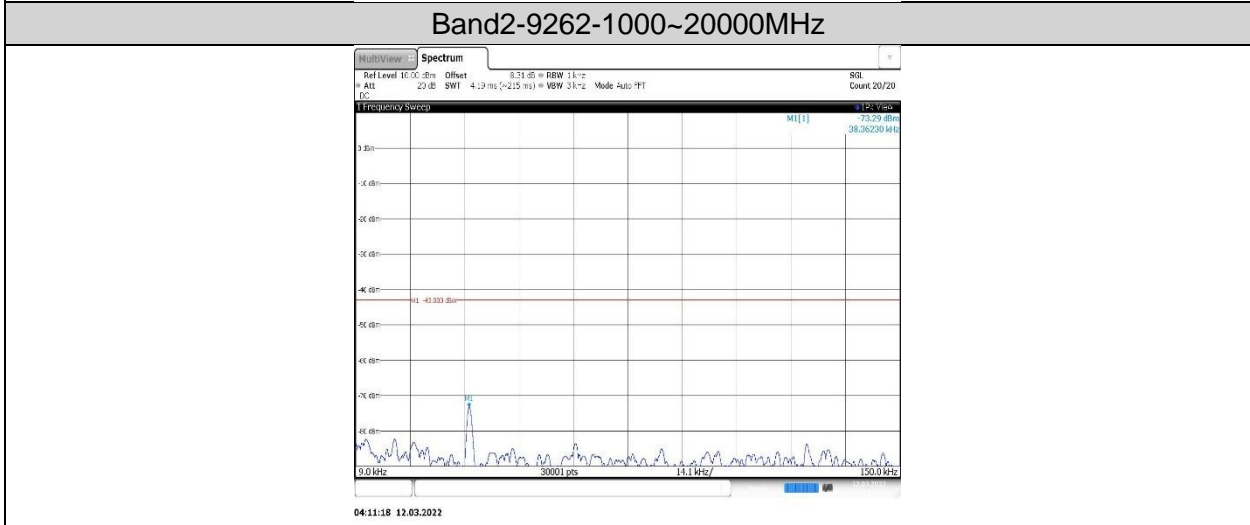
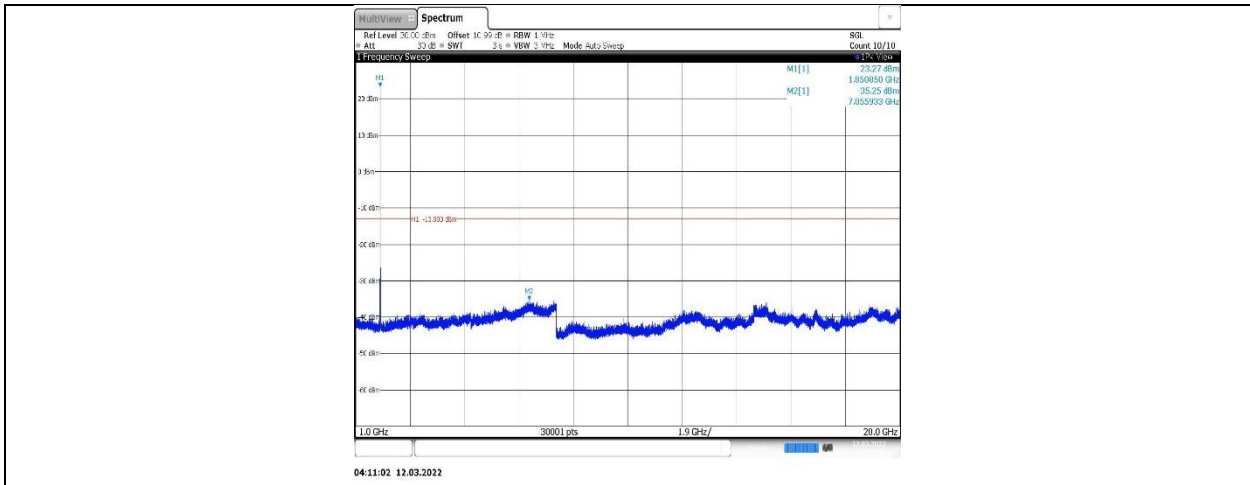

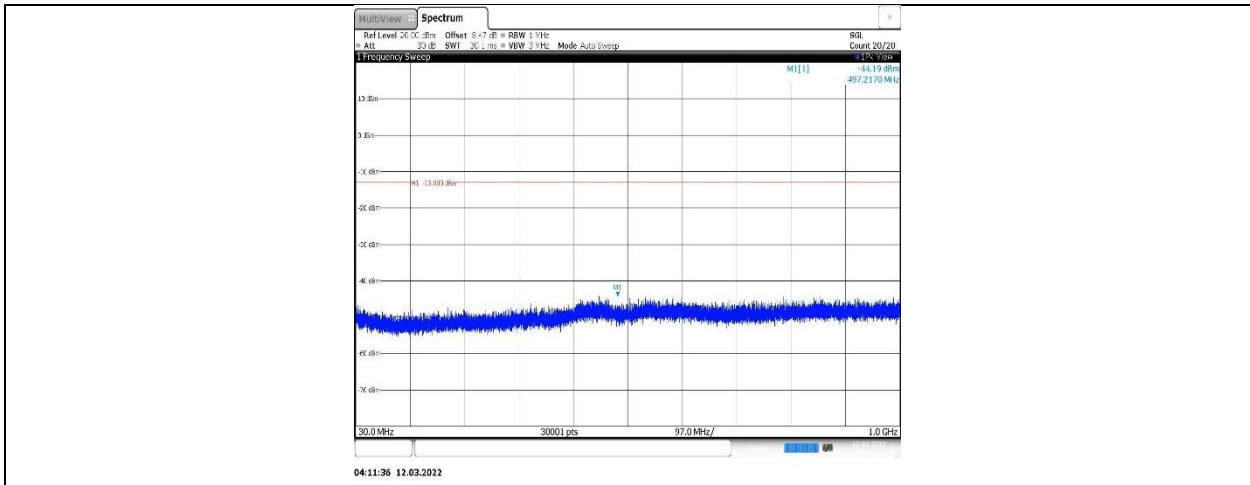

Band2-9400-30~1000MHz

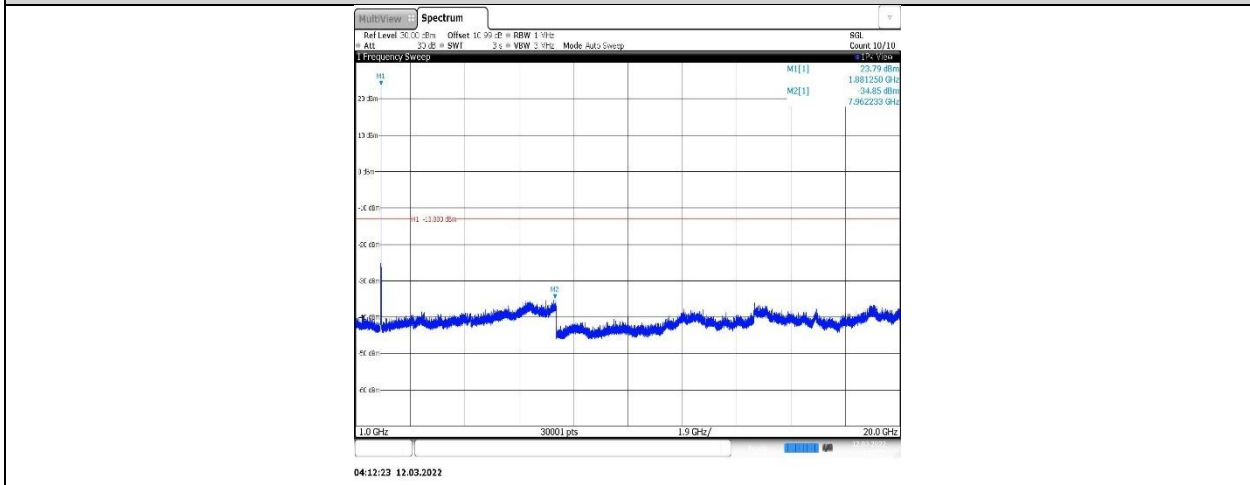

Band2-9400-1000~20000MHz

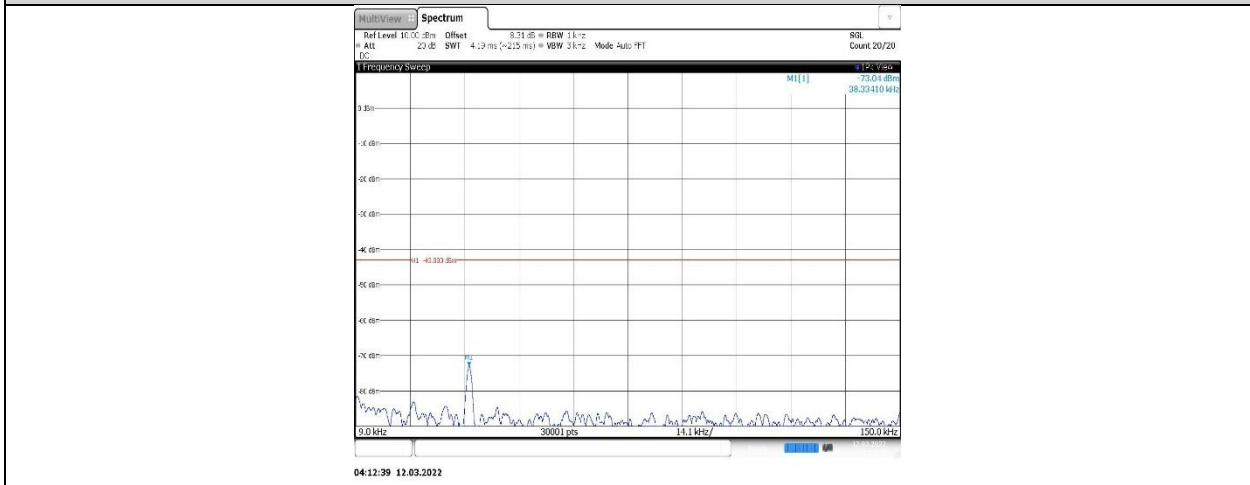

Band2-9538-0.009~0.15MHz

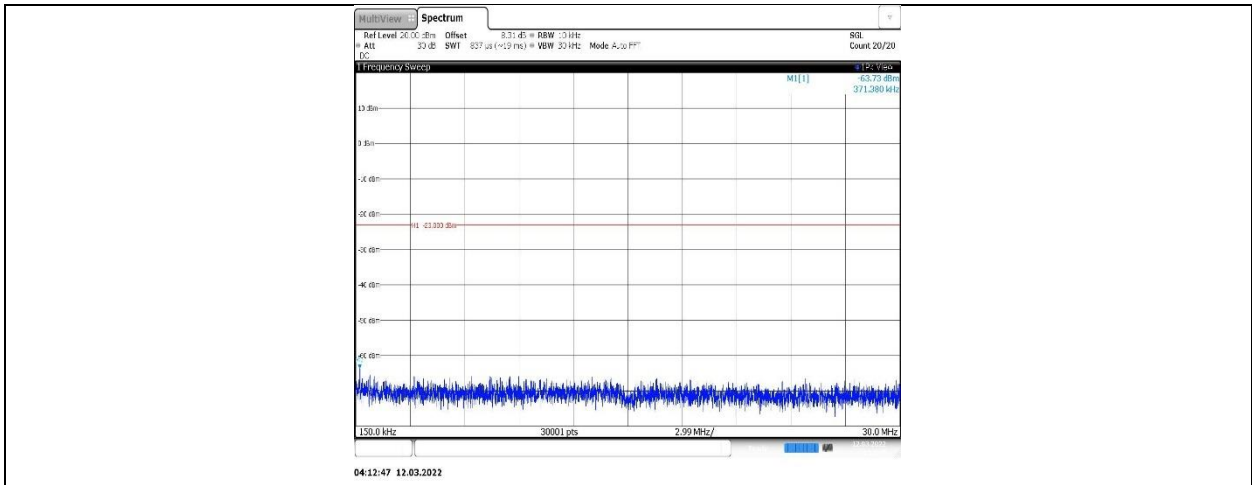

Band2-9538-0.15~30MHz

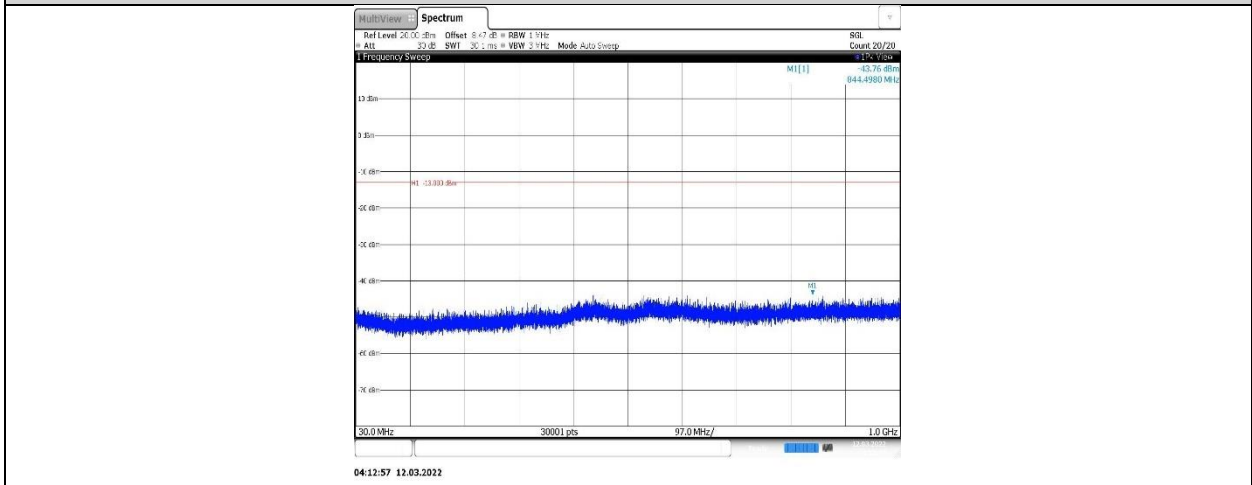

Band2-9538-30~1000MHz

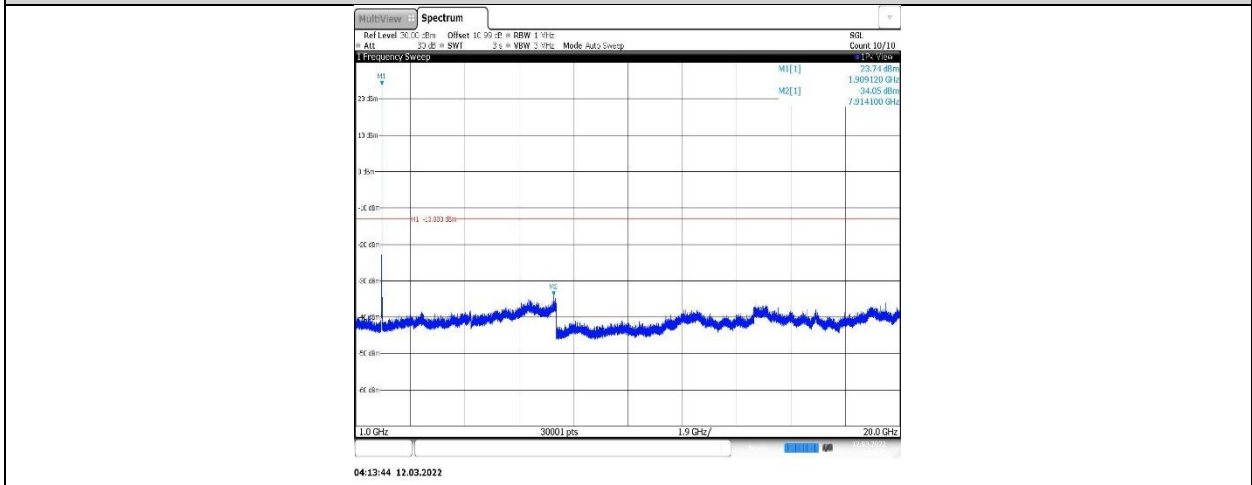

Band2-9538-1000~20000MHz

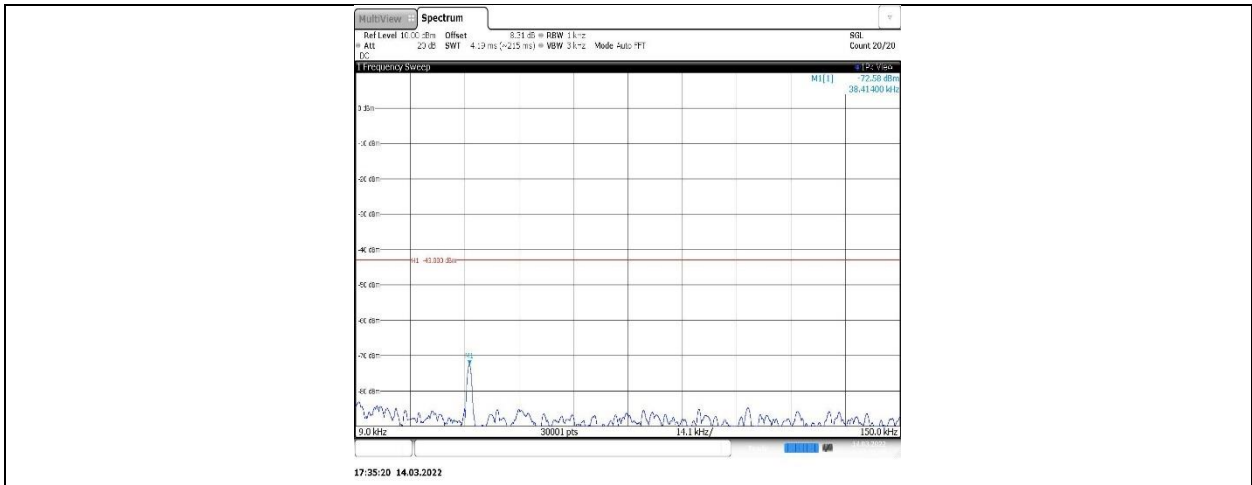

Band4-1312-0.009~0.15MHz

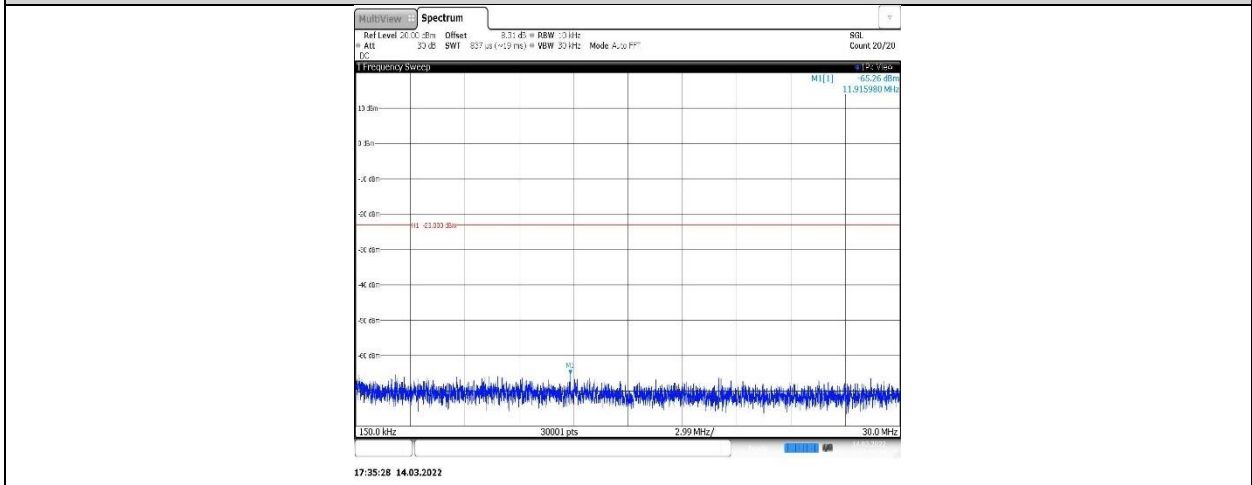

Band4-1312-0.15~30MHz

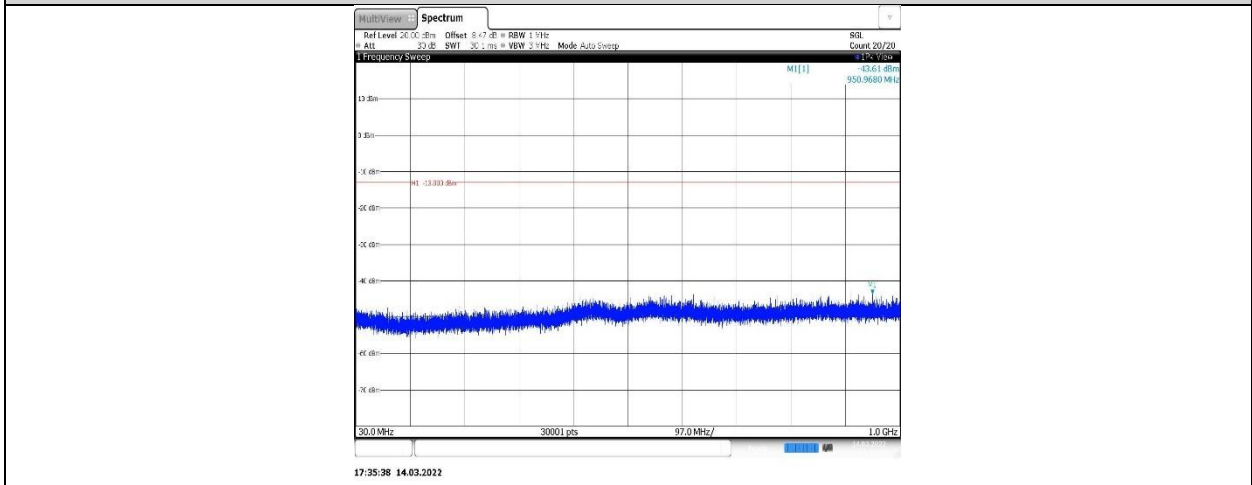

Band4-1312-30~1000MHz

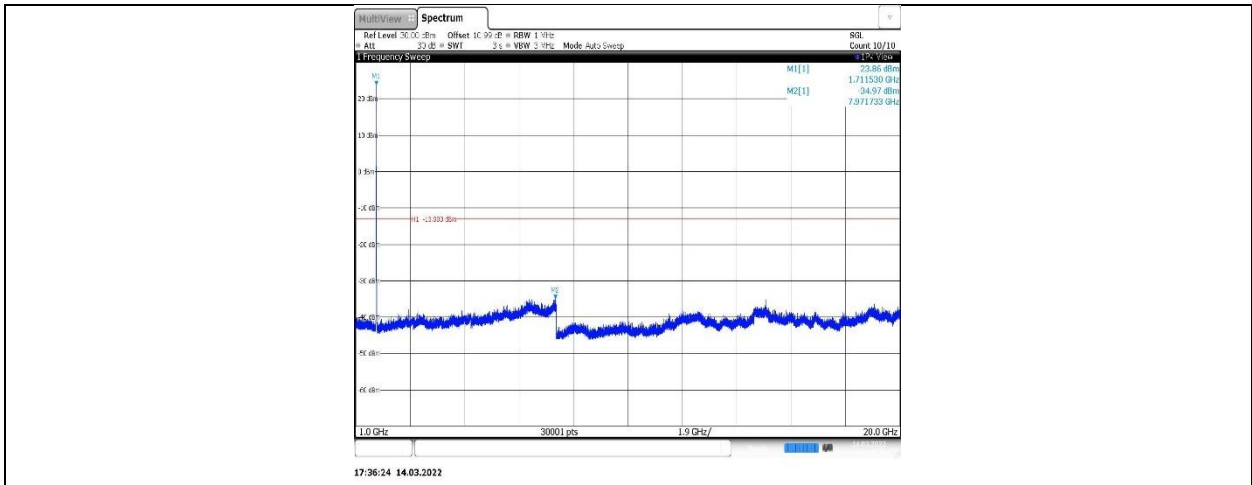

Band4-1312-1000~20000MHz

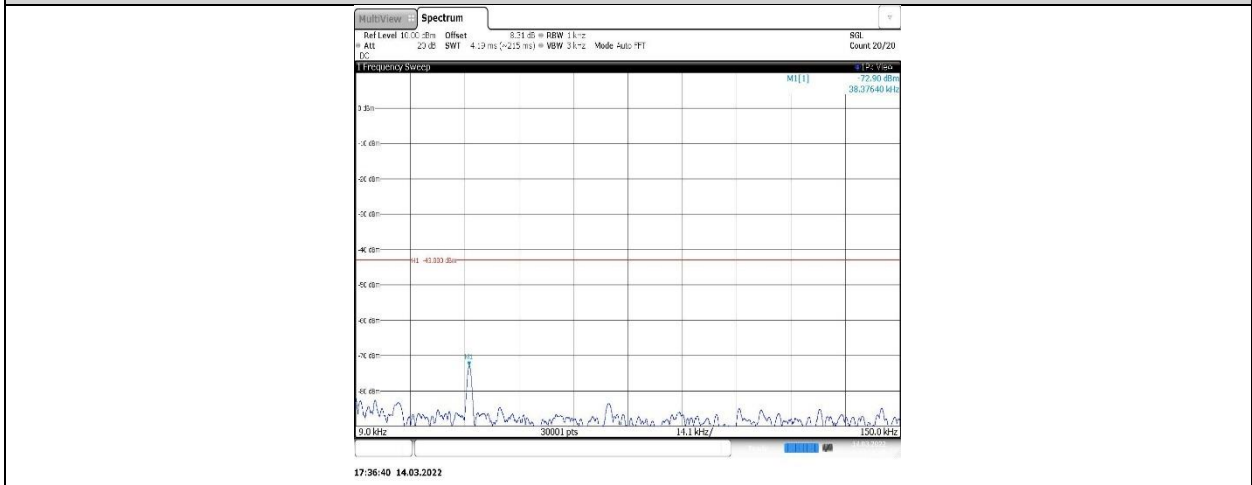

Band4-1413-0.009~0.15MHz

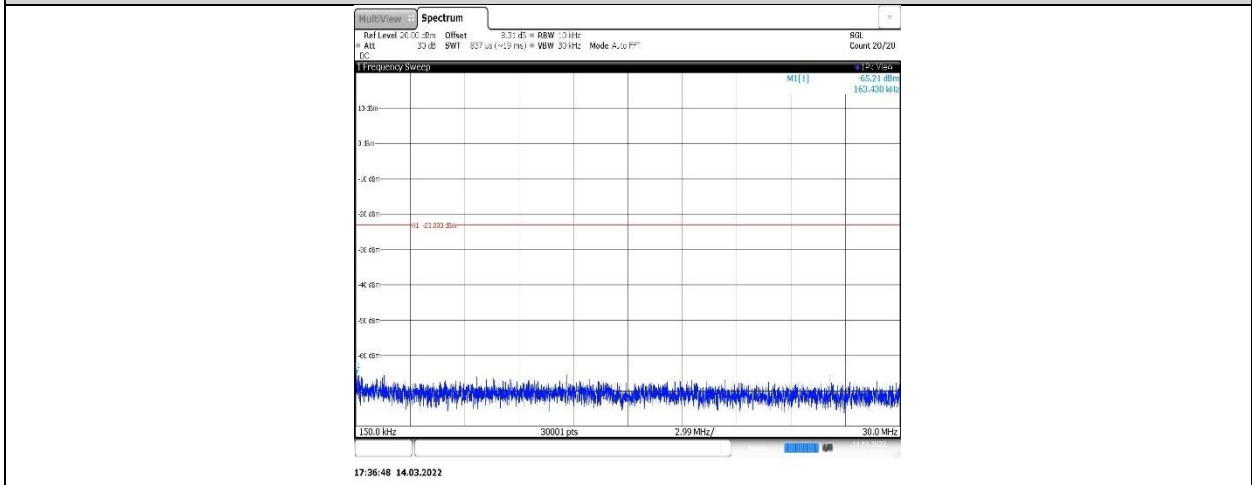

Band4-1413-0.15~30MHz

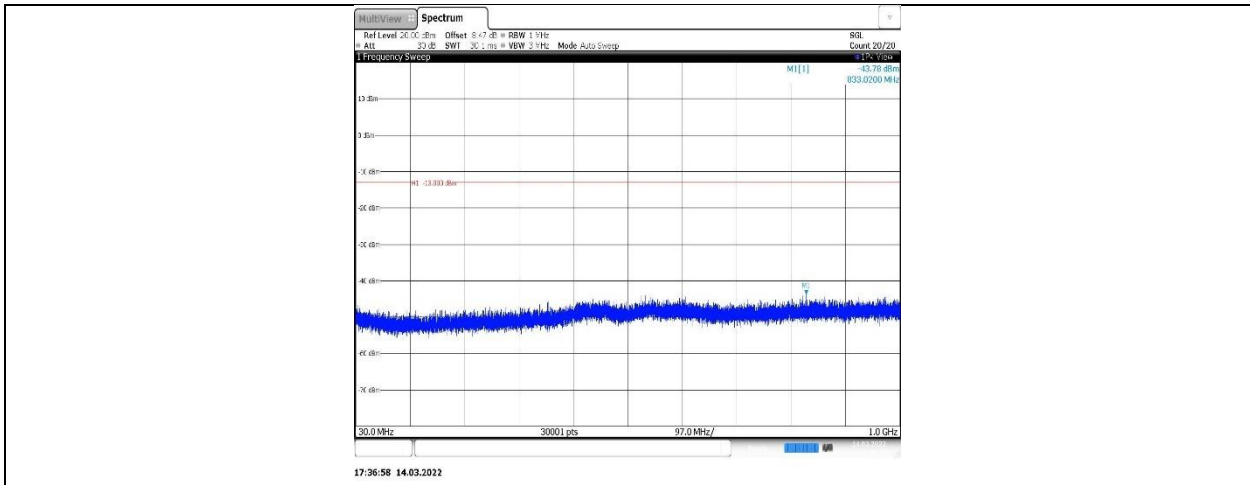

Band4-1413-30~1000MHz

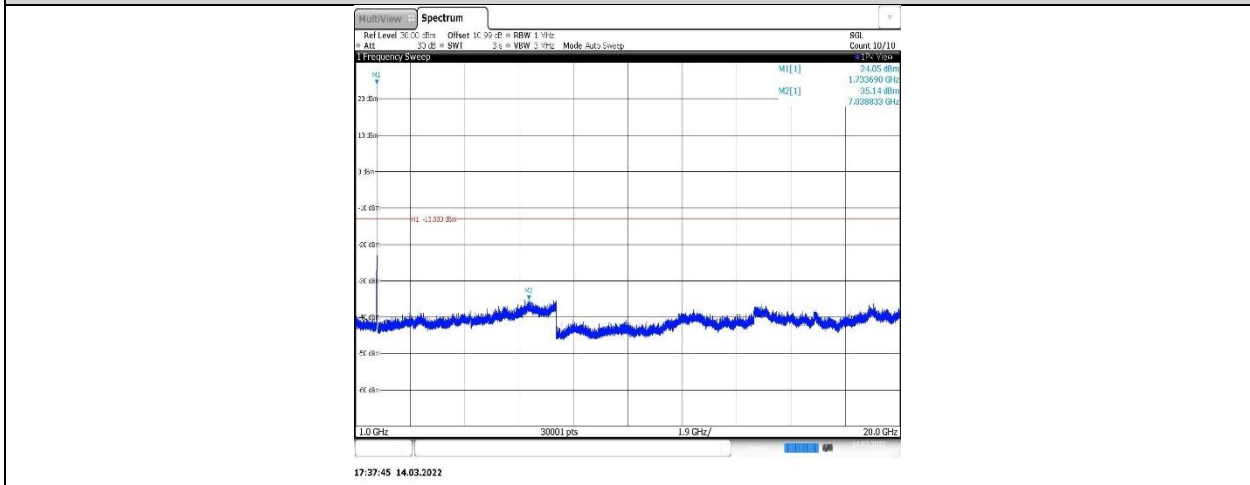

Band4-1413-1000~20000MHz

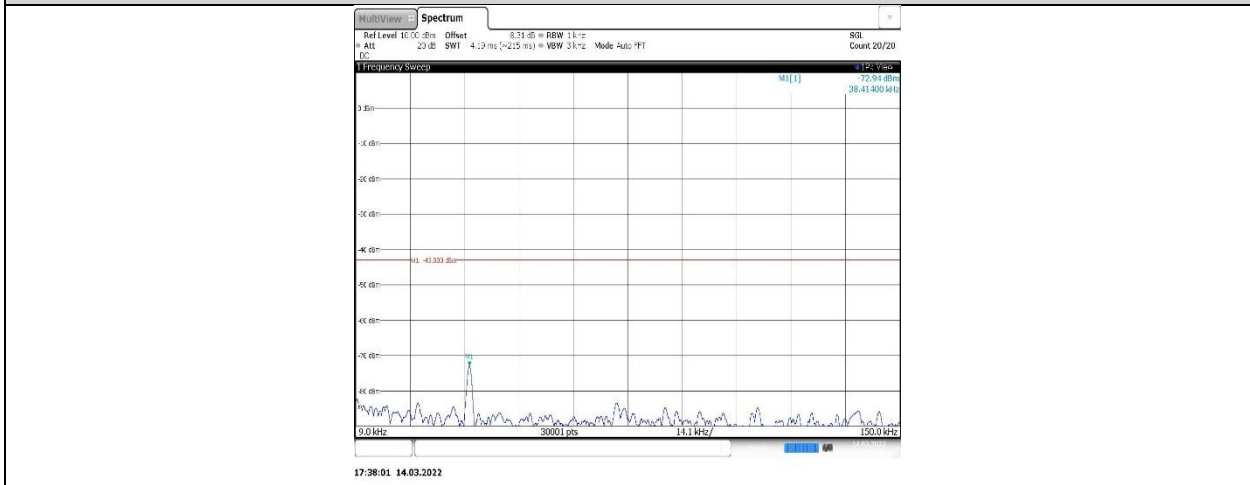

Band4-1513-0.009~0.15MHz

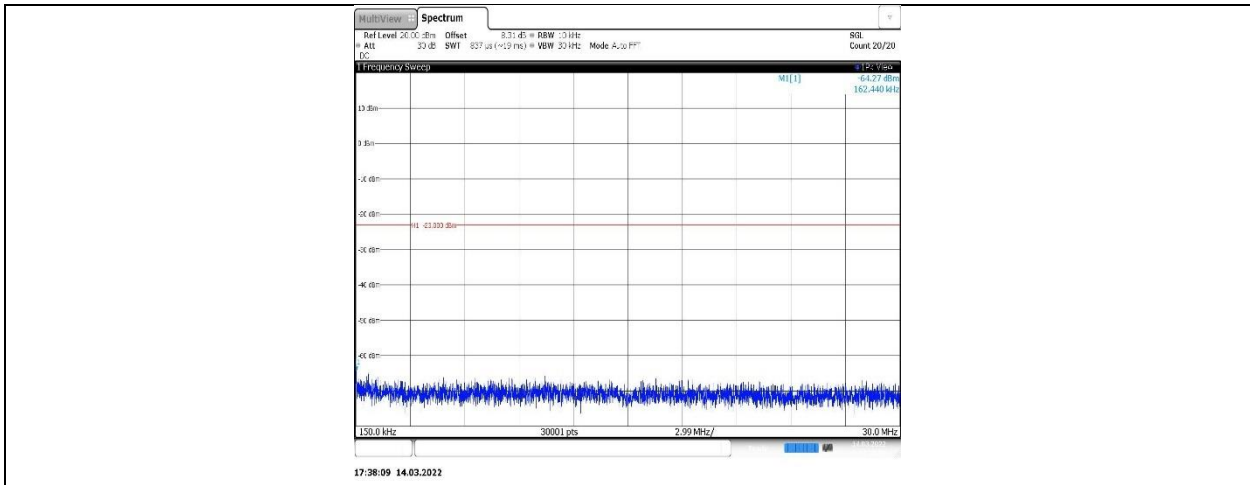

Band4-1513-0.15~30MHz

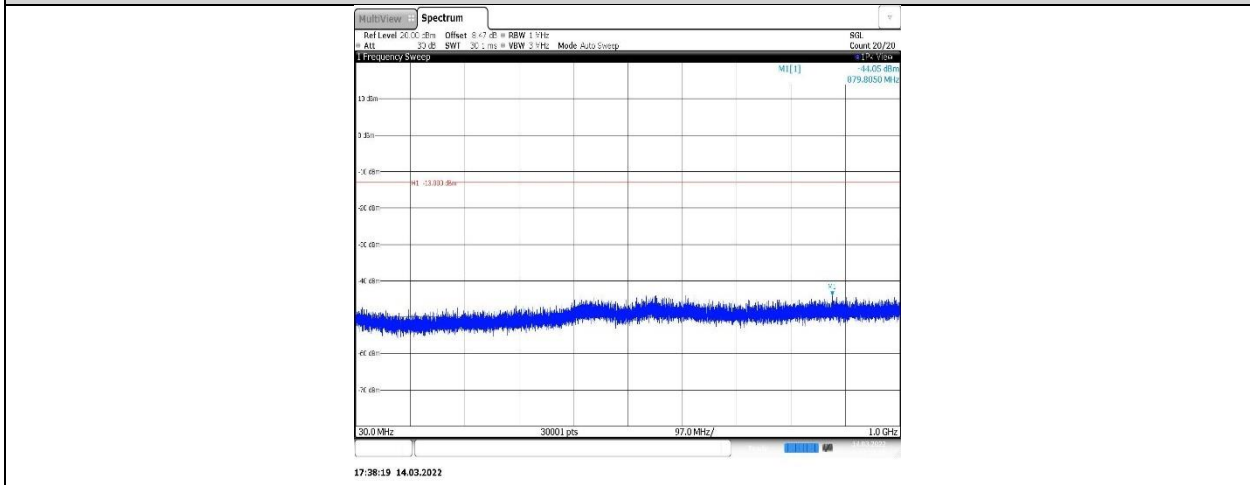

Band4-1513-30~1000MHz

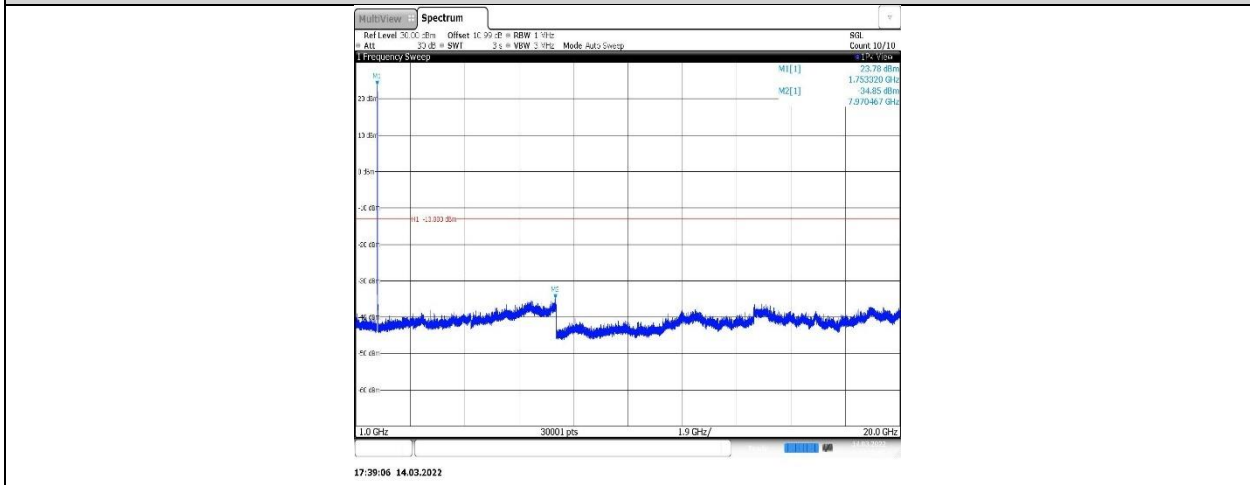

Band4-1513-1000~20000MHz



HSDPA

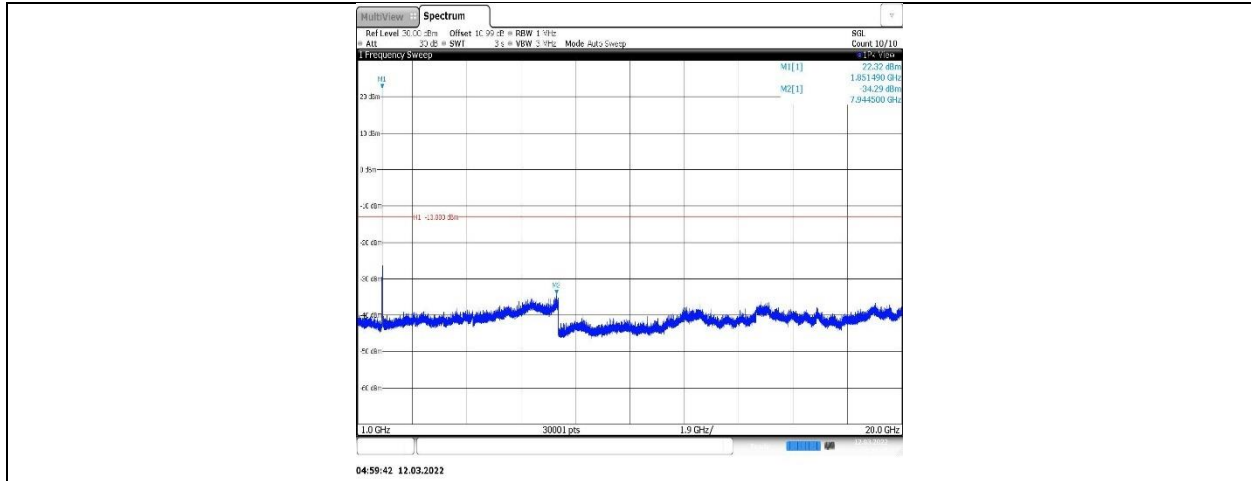

Band2-9262-4-1000~20000MHz

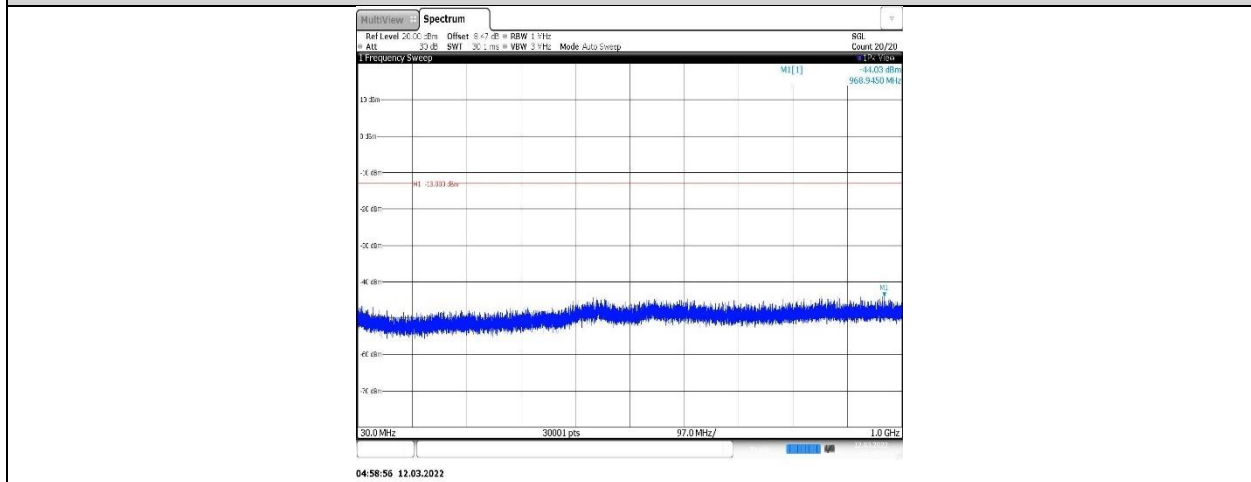

Band2-9262-4-30~1000MHz

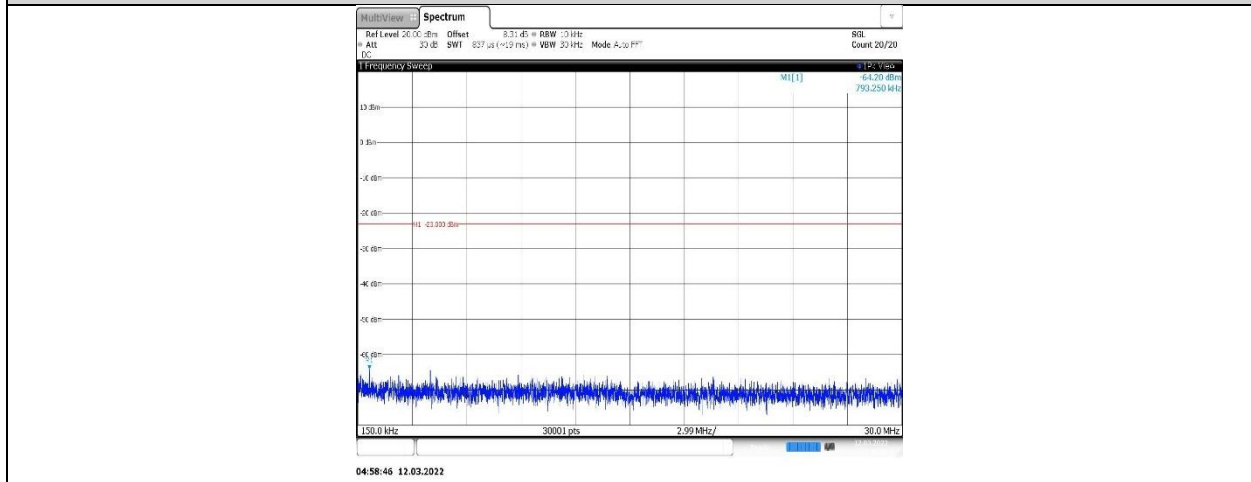

Band2-9262-4-0.15~30MHz