

Liquid Tank

Infusion

Twist the Cap counterclockwise to open the tank. Upon infusion, screw the Cap clockwise till tight.

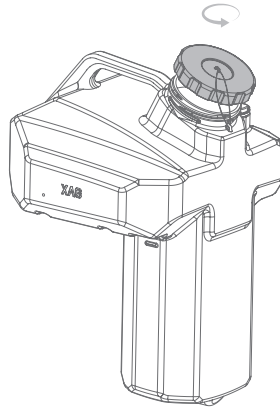

Warning

⚠ To protect the parts from chemical splash damage, direct pesticide infusion is NOT allowed when the tank is installed on the UAV.

Tank Removal/Installation

Pick up with force/put down with care to remove/install the Liquid Tank.

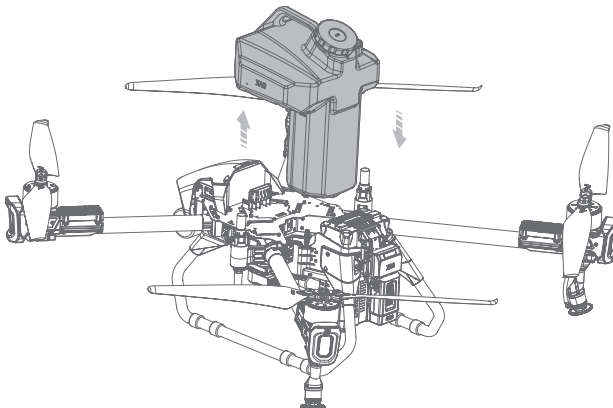

Warning

- ⚠ Please DO handle the tank with pesticide inside with care.
- ⚠ Emptying liquid tank/granule container beforehand to enhance the efficiency of aerial mapping is recommended.
- ⚠ A drone installing RealTerra is unable to spray or spread.

APP Interface Introduction

"Field" Tab (Main)



Device List: Full device list

Operator: Operator's location

"Field" Tab: Main field options tab

Functions: New fields, New fields group,
New HDMap, Import data, Bind
devices

Map Layers: Select map type

Focus on Aircraft: Centre screen on aircraft

Focus on Operator: Centre screen on
operator

Measure: Measure distance

Aircraft: Aircraft's location

"Operation" Tab: Main operation options
tab

"My Account" Tab: Main account options tab

"Operation" Tab

Tap on "Operation" tab to view the operation options.

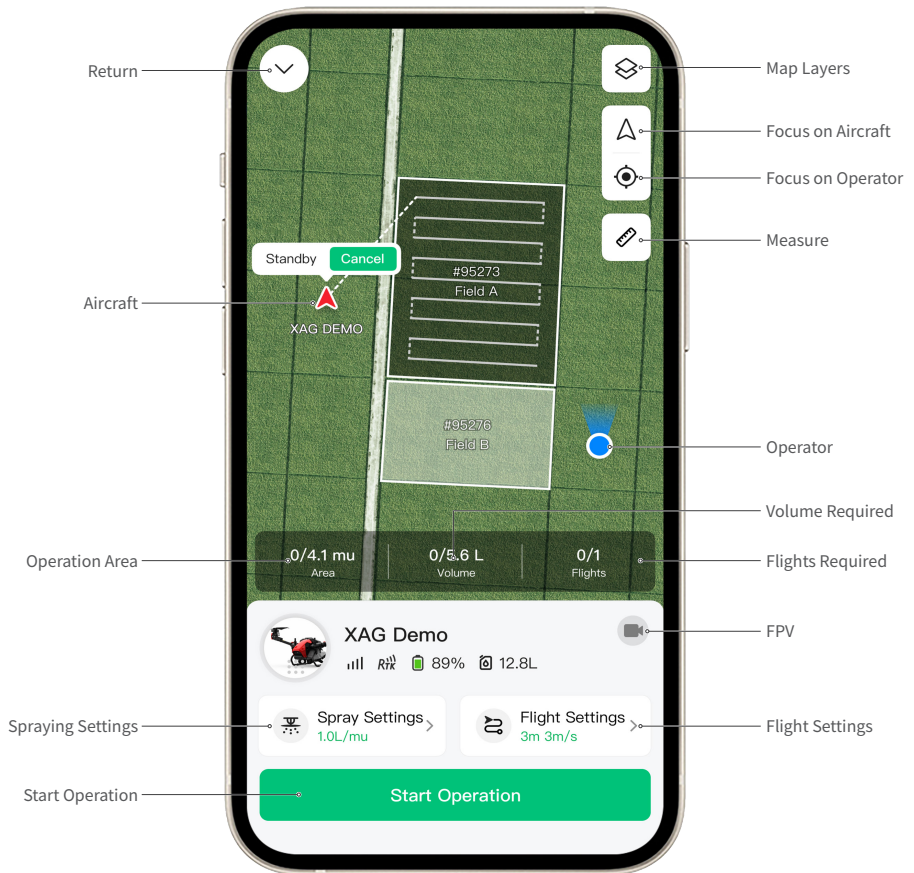

Return: Return to "Field" Tab (Main)

Operation Area: Area of selected field

Spraying Settings: Spraying settings

Start Operation: Start operation

Volume Required: Estimated volume required
for current operation

Flights Required: Estimated flights required
for current operation

FPV: First-person-view camera

Flight Settings: Flight settings

Appendix

Wiring Quick Guide

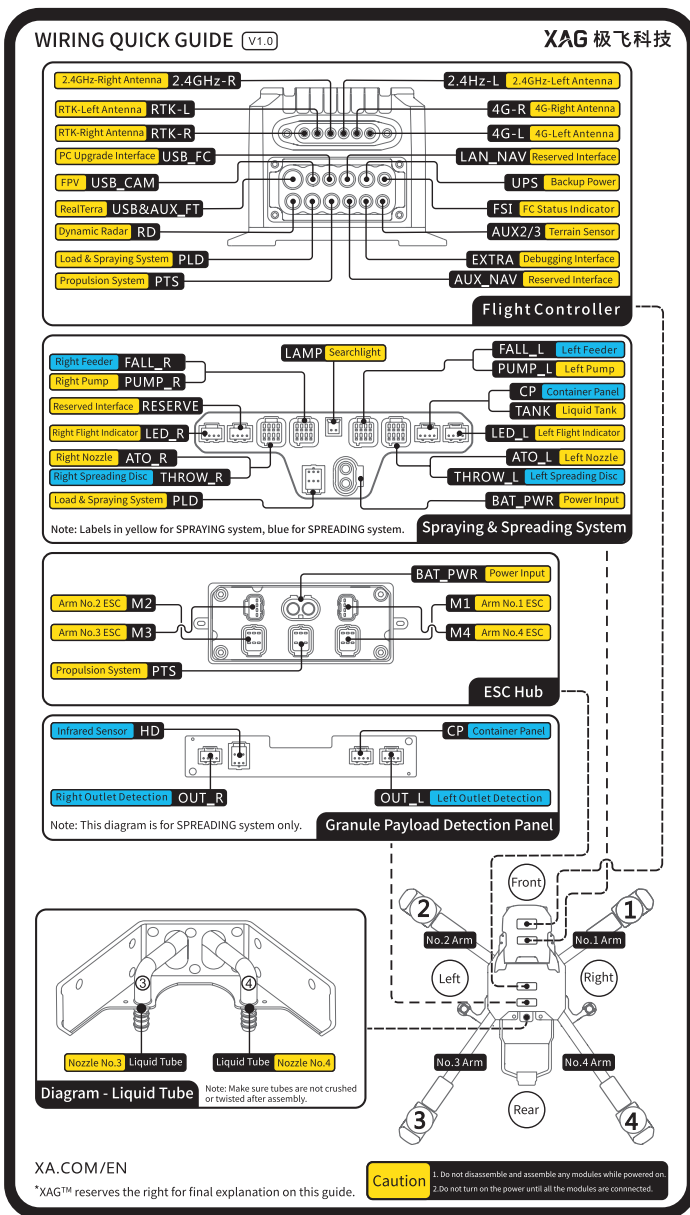

△ The guideline in this page is applicable for all the connections of P40 Agricultural UAV.

Description of Status Indicator











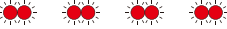

Super X4 Intelligent Control System Indicator

Get to know the current status of the drone by checking Super X4 Intelligent Control System Indicator. Details are as follows:

RTK Indicator		Description
Flashing Green Light (slow)		Normal
Flashing Green Light (rapid)		Insufficient satellites (<16), heading accuracy: <math><2^\circ</math>
Flashing Red Light (slow)		RTK timeout exceeding 10s
Flashing Red Light (rapid)		Exit RTK, no differential signal, no heading
Solid Red Light		Not searching for satellites, not positioning, no output from board
Red/Green Light Alternate Flashing(slow)		Initialization/Configuration
Red/Green Light Alternate Flashing(rapid)		Firmware Update
Wireless Communication Indicator		Description
Flashing Green Light (slow)		Communication module normal, DLS receiving and processing data
Flashing Green Light (rapid)		Communication module normal, no data received
Flashing Red Light (slow)		Initialization normal, serial port disconnected
Flashing Red Light (rapid)		Interface disconnected, initialization failed
Red/Green Light Alternate Flashing		Pairing. Indicators will become Green Light Fast Flash whether the pairing is successful or not
Cloud Communication Indicator		Description
Cloud Communication Indicator		Cloud communication connected
Cloud Communication Indicator		Cloud communication disconnected
System Status Indicator		Description
Solid Green Light		System normal
Solid Red Light		System anomalous







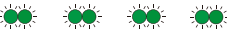

Flight Indicator

There are one Flight Indicator on the side of each motor mount, Details are as follows.

Flight Indicator		Description
Solid Green Light		Spraying
Illumination Green		Spraying paused for line changing
Double Flashing Red Light		Taking off or landing
Solid Red Light		Idling or obstacle avoidance in process
Illumination Red		Departure or RTL
Solid Cyan Light		Initializing firmware update
Flashing Cyan Light (rapid)		Downloading firmware
Flashing Purple Light (slow)		Subsystem update
Flashing Purple Light (rapid)		Transmitting subsystem firmware
Illumination Blue		No signal from flight controller
Flashing Blue Light (rapid)		Spray system offline
Solid Yellow Light		System crash

Flight Status Indicator

Get to know the current status of the drone by checking the Flight Status Indicators (Tail Lights). Details are as follows.

Tail Lights		Description
Red/Green Light Alternate Flashing(slow)		Weak GPS signal
Double Flashing Green Light		Strong GPS signal
Triple Flashing Green Light		GPS route mode
Flashing Red Light(slow)		Fly in safe mode
Solid Red Light		Powered on, Flight Control initialization incomplete or heating up
Flashing Purple Light(rapid)		Flight Control formatted or parameter anomalous
Flashing Blue Light(rapid)		Propulsion system detected as anomalous
Flashing Red Light(rapid)		Sensors (excluding IMU) anomalous, GPS malfunction or low heading accuracy
Flashing White Light(rapid)		IMU failure
Triple Flashing Red Light		Low voltage alert

Specifications

P40 Agricultural UAV

Model	3WWDZ-20BH
Flight Control System	SuperX 4
Symmetrical Motor Wheelbase	1560mm
Dimensions	1280×1280×550mm
Empty Weight	28.1kg (Spraying system and battery included) 32kg (Spreading system and battery included)
Rated Takeoff Weight	48.1kg (Spraying) 48.1kg (Spreading)
Protection Rating	IP67

Flight Parameters

Operating Frequency	2.4000 GHz-2.4835 GHz
Maximum Thrust-Weight Ratio:	1.6
Hovering Precision (good GNSS signal)	RTK Enabled: ±10cm (horizontal), ±10cm (vertical) RTK Disabled: ±0.6m (horizontal), ±0.3m (vertical) (radar enabled: ±0.1m)
Continuous High Precision Navigation Time without Signa	≤ 600s
Hovering Duration	19.3min (with No-load @20000mAh & Takeoff Weight: 28.1kg) 7.3min (with Full-load @20000mAh & Takeoff Weight: 48.1kg)
Maximum Flying Speed	10m/s
Maximum Flying Height	30m
Maximum Flight Distance	2000m
Wind Force Recommended	≤ 3

RevoSpray System

Smart Liquid Tank

Volume	20L
Sensor	Liquid Level Sensor

Nozzle

Quantity	2
Rotational speed of spray disc	1000~16000rpm/min
Atomizing Size	60-400μm
Spray Width	5~10m

Peristaltic Pump

Quantity	2
Voltage	50V
Maximum System Flow Rate	10L/min
Maximum flow rate (single pump)	5L/min

XAG RealTerra

Image Sensor	1/2.3inch 12M CMOS Sensor
--------------	---------------------------

Lens	FOV 112° 2.7mm/16.8mm (35mm Equivalent)
Mechanical Shutter	1/200-1/2000s
Image Format	JPG
Power	10W
Optimum Operating Temperature	10~40°C

PSL Camera

Dimensions	50 x 36.7 x 29mm
Video Resolution	720P/1080P
Video Coding Format	H.264
Frame Rate	30fps
Focal Length	2.75mm
Image Sensor	1/2.95inch 2M CMOS Sensor

Obstacle Sensing & Avoidance System

Dynamic Radar

Model	RD2436
Voltage	24~60V
Power	6W
Operating Frequency	24GHz
Sensing Mode	Millimeter-wave Imaging, MTMR
Sensing Parameters	Obstacle's Position, Distance, Direction of Motion, Relative Velocity
Field of View (FOV)	Horizontal $\pm 40^\circ$; Vertical $\pm 45^\circ$
Relative Height of Safe Obstacle Avoidance	1.5m
Relative Speed of Safe Obstacle Avoidance	2.5m (Distance between the propeller tip and obstacle after the UAV brakes and hovers stably)
Relative Speed of Safe Obstacle Avoidance	$\leq 6\text{m/s}$

Terrain Sensor

Model	TR24S100
Voltage	5.8V
Power	1.5W
Sensing Mode	Millimeter-wave
Operating Frequency	24GHz
Height Measurement Range	0.5~100m
Fixed Height Range	45° (at flying speed of $\leq 2\text{m/s}$)
Protection Rating	IP67

Propulsion System

Motor

Model	A25
-------	-----

Stator Size	80 x 25mm
-------------	-----------

KV Value	85rpm/V
----------	---------

Maximum Tension (Single Motor)	20kg
--------------------------------	------

Rated Power (Single Motor)	1500W
----------------------------	-------

Electronic Speed Controller

Model	VC13180
-------	---------

Maximum Continuous Operating Current	180A
--------------------------------------	------

Maximum Operating Voltage	56.6V
---------------------------	-------

Foldable Propeller

Model	P40128
-------	--------

Diameter × Screw Pitch	40 x 12.8inch
------------------------	---------------

Tilt Servo

Rated Voltage	DC50V
---------------	-------

Operating Voltage	DC25V-55V
-------------------	-----------

Rated Torque	150Kg·cm@50V
--------------	--------------

Rated Current	0.5A@50V
---------------	----------

No Load Speed	400° /second
---------------	--------------

Communication & Control System

ACS2(B) Smart ControlStick

Compatible with	XAG® V40 Agricultural UAV, XAG® P40 Agricultural UAV, XAG® P80 Agricultural UAV
-----------------	---

Operating Frequency	2.4GHz
---------------------	--------

Power Consumption	4W (without RTK module), 8-9W (with RTK module)
-------------------	---

Ambient Operating Temperature	-20~60°C
-------------------------------	----------

Ambient Charging Temperature	5~45°C
------------------------------	--------

Power System

Smart SuperCharge Battery

Model	B13960S
-------	---------

Type	13S Lithium polymer battery
------	-----------------------------

Rated Capacity	20Ah (962Wh)
----------------	--------------

Rated Output	48.1V/120A/5500W
--------------	------------------

Fast Charge	56.55V/50A/2800W
-------------	------------------

SuperCharge	56.55V/80A/4500W
-------------	------------------

Ambient Charging Temperature	10~45°C
------------------------------	---------

Note

 The effectiveness of the Obstacle Sensing & Avoidance System depends on the obstacle's material, location, shape, size, etc. Please ensure the drone is always in your sight during operation. Pay close attention to the drone and use the ControlStick to avoid obstacles when necessary.

FCC/ISED Compliance Notice

This device complies with Part 15 of the FCC Rules and ISED licence-exempt RSS standard.. Operation is subject to the following two conditions:

- (1) This device may not cause harmful interference, and
- (2) This device must accept any interference received, including interference that may cause undesired operation.

Any changes or modifications not expressly approved by the party responsible for compliance could void the user's authority to operate the equipment.

Cet appareil est conforme à la section 15 du règlement de la FCC et à la norme RSS sans licence ISED. Son utilisation est soumise aux deux conditions suivantes:

- (1) Cet appareil ne doit pas causer d'interférences nuisibles, et
- (2) Cet appareil doit accepter toutes les interférences reçues, y compris celles susceptibles de provoquer un fonctionnement indésirable.

Tout changement ou modification non expressément approuvé par la partie responsable de la conformité peut annuler le droit de l'utilisateur à utiliser l'équipement.

This equipment has been tested and found to comply with the limits for a Class A digital device, pursuant to part 15 of the FCC Rules. These limits are designed to provide reasonable protection against harmful interference when the equipment is operated in a commercial environment. This equipment generates, uses and can radiate radio frequency energy and, if not installed and used in accordance with the instruction manual, may cause harmful interference to radio communications. Operation of this equipment in a residential area is likely to cause harmful interference in which case the user will be required to correct the interference at his own expense.

RF Exposure Information

Aircraft complies with FCC/ISED radiation exposure limits set forth for an uncontrolled environment. In order to avoid the possibility of exceeding the FCC/ISED radio frequency exposure limits, human proximity to the antenna shall not be less than 20cm during normal operation.

For Remote Controller (model:GL300N), SAR tests are conducted using standard operating positions accepted by the FCC/ISED with the device transmitting at its highest certified power level in all tested frequency bands, although the SAR is determined at the highest certified power level, the actual SAR level of the device while operating can be well below the maximum value. Before a new model is available for sale to the public, it must be tested and certified to the FCC/ISED that it does not exceed the exposure limit established by the FCC/ISED, Tests for each product are performed in positions and locations as required by the FCC/ISED. For Handheld operation, this device has been tested and meets the FCC/ISED RF exposure guidelines when used with an accessory designated for this product or when used with an accessory that contains no metal.

For body worn operation, Remote Controller (model:GL300N) has been tested and meets the FCC/ISED RF exposure guidelines when used with an accessory designated for this product or when used with an accessory that Contains no metal and that positions the handset a minimum of 0 cm from the body.

Non-compliance with the above restrictions may result in violation of RF exposure guidelines.

Informations sur l'exposition RF

L' aéronef est conforme aux limites d' exposition aux rayonnements FCC/ISEDc établies pour un environnement non contrôlé. Afin d'éviter tout risque de dépassement des limites d'exposition aux radiofréquences FCC/ISEDc, la proximité humaine de l'antenne ne doit pas être inférieure à 20 cm en fonctionnement normal.

Pour le contrôleur à distance (modèle GL300N), les tests SAR sont effectués sur des positions de fonctionnement standard acceptées par la FCC/ISEDc, le dispositif émettant à son niveau de puissance certifié le plus élevé dans toutes les bandes de fréquences testées, bien que le SAR soit déterminé au niveau de puissance certifié le plus élevé, le niveau de SAR réel de l'appareil en cours d'utilisation peut être bien inférieur à la valeur maximale. Avant qu'un nouveau modèle ne soit disponible à la vente au public, il doit être testé et certifié conforme par la FCC/ISEDc qu'il n'excède pas la limite d'exposition établie par la FCC/ISEDc. Les tests de chaque produit sont effectués à requis par la FCC/ISEDc. En mode portatif, cet appareil a été testé et respecte les directives d'exposition RF de la FCC/ISEDc lorsqu'il est utilisé avec un accessoire conçu pour ce produit ou avec un accessoire ne contenant pas de métal.

Pour le fonctionnement sur le corps, la télécommande (modèle GL300N) a été testée et répond aux directives d'exposition RF de FCC/ISEDc lorsqu'elle est utilisée avec un accessoire conçu pour ce produit ou avec un accessoire ne contenant pas de métal et positionnant le combiné au minimum de 0 cm du corps.

Le non-respect des restrictions ci-dessus peut entraîner une violation des consignes d'exposition aux RF.

EU Compliance Statement:Guangzhou Xaircraft Technology CO.,LTD.All Rights Reserved. hereby declares that this device is in compliance with the essential requirements and other relevant provisions of the RED Directive. This equipment must be installed and operated in accordance with provide instructions and the antenna used for this transmitter must be installed to provide a separation distance of at least 20cm from all persons and must not be co-located or operation in conjunction with any other antenna or transmitter.End-users and installers must be provide with antenna installation instructions and transmitter operating conditions for satisfying RF exposure compliance.



Warning: Operation of this equipment in a residential environment could cause radio interference.

KCC Warning Message

해당무선설비는 운용중전파혼신가능성이있

해당무선설비는전파혼신가능성이있으므로인명안전과관련된서비스는할수없음

NCC Warning Message

低功率電波輻射性電機管理辦法

第十二條 經型式認證合格之低功率射頻電機，非經許可，公司、商號或使用者均不得擅自變更 頻率、加大功率或變更原設計之特性及功能。

第十四條 低功率射頻電機之使用不得影響飛航安全及干擾合法通信；經發現有干擾現象時，應 改善至無干擾時方得繼續使用。前項合法通信，指依電信法規定作業之無線電通信。低功率射頻 電機須忍受合法通信或工業、科學及醫療用電波輻射性電機設備之干擾。 應避免影響附近雷達系統之操作。

高增益指向性天線只得應用於固定式點對點系統。

FCC Warning statements in User Manual

FCC RF Radiation Exposure Statement:This equipment complies with FCC radiation exposure limits set forth for an uncontrolled environment. This equipment should be installed and operated with a minimum distance of 20cm between the radiator and any part of your body.

This device complies with Part 15 of the FCC Rules. Operation is subject to the following two conditions: (1) this device may not cause harmful interference, and (2) this device must accept any interference received, including interference that may cause undesired operation.

Caution: The user is cautioned that changes or modifications not expressly approved by the party responsible for compliance could void the user's authority to operate the equipment.

Note: This equipment has been tested and found to comply with the limits for a Class A digital device, pursuant to part 15 of the FCC Rules. These limits are designed to provide reasonable protection against harmful interference when the equipment is operated in a commercial environment. This equipment generates, uses, and can radiate radio frequency energy and, if not installed and used in accordance with the instruction manual, may cause harmful interference to radio communications. Operation of this equipment in a residential area is likely to cause harmful interference in which case the user will be required to correct the interference at his own expense.

FCC Supplier' s Declaration of Conformity

Brand name / model number : 3WWDZ-20BH

This device complies with part 15 of the FCC Rules. Operation is subject to the following two conditions: (1) This device may not cause harmful interference, and (2) this device must accept any interference received, including interference that may cause undesired operation.

Suppliers Name : HOMELAND SURVEILLANCE AND ELECTRONICS LLC

Suppliers Address (USA) : 122 LIVE OAKS BLVD.CASSELBERRY, FL 32707

Suppliers phone number and / or internet contact information: 46-2381710

APPENDIX C

Important information required for User / Operation Manual

If not provided elsewhere, the Declaration of Conformity shall be included in the user manual/operational manual, or the simplified DoC shall be included in the user manual or operation manual in the way shown as below:

1. Simplified Declaration of Conformity:

“Hereby, [*Guangzhou Xaircraft Technology CO.,LTD.*], declares that this [*P40 Agricultural UAV*] is in compliance with the essential requirements and other relevant provisions of *2014/53/EU*.

The full text of the EU declaration of conformity is available at the following internet address:
www.address.com/doc.pdf”

2. Where applicable, the user manual/operational manual shall include the SAR/RF exposure statement similar to the following:

“The device meets RF exposure guidelines when used against the head or when positioned at least xx mm away from the body. When a carry case, belt clip or other form of device holder is used for body-worn operation, it should not contain metal and should provide at least the above stated separation distance from the body.”

3. In cases of restrictions on putting into service or of requirements for authorization of use, necessary explanation and complete instructions about the restrictions or authorization shall be presented in the user manual/operational manual.

4. (a) Transmitting frequency band(s);

(b) Maximum allowed transmitting power in the frequency band(s) in which the radio equipment operates.

5. Any other necessary information, including intended use and installation.

Disclaimer

01. Please read this User Manual carefully before using the product, as it has much to do with both operational safety and your legitimate rights and interests. You shall be deemed to know, understand, agree and acknowledge all terms and conditions as well as content stated herein upon activation of this product.
02. Not being a toy, plus for certain safety risks, this product is not suitable for those who are under 18 years old, or those without a UAS operator certificate accredited by XAG or existing laws, regulations and policies. Please keep the children away from this product and be particularly cautious while there are children present.
03. This product is an XAG V-series multi-rotor unmanned aerial vehicle solely designed for agricultural use. With activation in accordance with the User Manual, properly functioned battery and data indicated as normal, it will provide you with safe and satisfactory plant protection service.
04. You commit to use this product only for a legitimate purpose and acknowledge the content stated herein as well as possible formulation and amendment of policies and norms by XAG. You understand, acknowledge and accept that flight records and data during operation will be automatically uploaded and saved to XAG's server as well as licitly collected and stored by XAG. XAG assumes no responsibility for the failure to store and analyze the flight records and data caused by the unsuccessful upload due to any reason attributable to you.
05. To the maximum extent permitted by law, under no circumstances shall XAG offer an implicit or explicit guarantee for this product, including but not limited to implicit guarantees pertaining to vendibility, fitness for a particular use, or non-infringement.
06. To the maximum extent permitted by law, XAG shall not be liable for all losses caused by your improper operation. Also, XAG shall not be liable for any indirect, consequential, punitive, accidental, special or exemplary damages, including any loss incurred as a result of your purchase, use, or inability to use the product (even if you have been advised of the possibility of such loss).
07. To the maximum extent permitted by law, under any circumstances, the liability or compensation amount from XAG to you for all damages, losses, and litigation arising therefrom will not exceed the amount that you paid to XAG or XAG accredited distributor for purchasing the product.
08. On any account, the purchaser or user shall comply with laws and regulations of the country and region where the product is used. XAG assume no liability arising from the violation of relevant laws and regulations by the purchaser or user.
09. As exclusion clauses may be prohibited by laws in some countries, your rights in different countries may vary. This does not imply that the content contained in this Disclaimer is necessarily invalid.
10. To the extent permitted by law, XAG reserves the rights for final explanation and revision of the terms and conditions stated herein. XAG also has the right to update, modify or terminate these terms and conditions via its official website, the Instruction Manual/User Manual, online APP, etc., without prior notice.

Warning

Users are required to read the full Instruction Manual and obtain UAS operator certificate accredited by XAG (or existing laws, regulations, and policies). Otherwise, it may cause serious injury to yourself or others, or cause damage to the product and property loss. Safety awareness is of paramount importance during operation. This product is not suitable for children. Do NOT use the parts that are not provided or suggested by XAG. Please install and use the product by strictly following XAG's instructions.



info@xa.com



@XAGofficial



@XAG_official



YouTube @XAG Official

XAG

This Manual is subject to update without prior notice.

©Guangzhou Xaircraft Technology CO., LTD. All Rights Reserved.

All information of this User Manual (including but not limited to any text description, illustrations, photos, methods and processes, etc.) belongs to Guangzhou Xaircraft Technology CO., LTD and is protected by copyright law. Without written authorization, no individual or institution is allowed to reproduce, extract, translate, distribute, or otherwise reproduce or quote any content hereof.