



Report No.: E01A22020118F00101

1 of 29

**ELECTROMAGNETIC EMISSIONS COMPLIANCE REPORT
INTENTIONAL RADIATOR CERTIFICATION TO
FCC PART 15 SUBPART C REQUIREMENT**

OF

Wireless Charging Stand

Model No.: 303-0079

Trademark: N/A

FCC ID: 2A45H303-0079

Report No.: E01A22020118F00101

Issue Date: Mar. 01, 2022

Prepared for

SHENZHEN CHENYANSHI TECHNOLOGY CO.,LTD

**ROOM 401,NO.41 QINGSHUI ROAD LONGXI COMMUNITY LONGGANG
DISTRICT,SHENZHEN CITY,GUANGDONG PROVINCE,CHINA**

Prepared by

Dong Guan Anci Electronic Technology Co., Ltd.

**1-2 Floor, Building A, No.11, Headquarters 2 Road, Songshan, Lake
Hi-tech Industrial Development Zone, Dongguan City, Guangdong Pr.,
China.**

**This report shall not be reproduced, except in full, without the written approval of
Dong Guan Anci Electronic Technology Co., Ltd.**



VERIFICATION OF COMPLIANCE

Applicant:	SHENZHEN CHENYANSHI TECHNOLOGY CO.,LTD. ROOM 401,NO.41 QINGSHUI ROAD LONGXI COMMUNITY LONGGANG DISTRICT,SHENZHEN CITY,GUANGDONG PROVINCE,CHINA
Manufacturer:	SHENZHEN CHENYANSHI TECHNOLOGY CO.,LTD. ROOM 401,NO.41 QINGSHUI ROAD LONGXI COMMUNITY LONGGANG DISTRICT,SHENZHEN CITY,GUANGDONG PROVINCE,CHINA
Product Description:	Wireless Charging Stand
Trade Mark:	N/A
Model Number:	303-0079

We hereby certify that:

The above equipment was tested by Dong Guan Anci Electronic Technology Co., Ltd. The test data, data evaluation, test procedures, and equipment configurations shown in this report were made in accordance with the procedures given in ANSI C63.10-2013 and the energy emitted by the sample EUT tested as described in this report is in compliance with conducted and radiated emission limits of FCC Rules Part 15.209(2020).

Date of Test : Feb. 18, 2021 to Mar. 01, 2022

Prepared by : 
Tomas Yang/Supervisor

Reviewer & Authorized Signer : 
Alan He/Manager





Modified Information

Version	Summary	Revision Date	Report No.
Ver.1.0	Original Report	/	E01A22020118F00101



Table of Contents

1 GENERAL INFORMATION	5
1.1 PRODUCT DESCRIPTION	5
1.2 RELATED SUBMITTAL(S) / GRANT(S)	6
1.3 TEST METHODOLOGY	6
1.4 SPECIAL ACCESSORIES	6
1.5 EQUIPMENT MODIFICATIONS	6
1.6 TEST FACILITY	6
2 SYSTEM TEST CONFIGURATION.....	7
2.1 EUT CONFIGURATION	7
2.2 EUT EXERCISE	7
2.3 TEST PROCEDURE	7
2.4 CONFIGURATION OF TESTED SYSTEM.....	8
3 SUMMARY OF TEST RESULTS.....	8
4 TEST SYSTEM UNCERTAINTY.....	9
5 CONDUCTED EMISSIONS TEST	10
5.1 MEASUREMENT PROCEDURE	10
5.2 TEST SET-UP (BLOCK DIAGRAM OF CONFIGURATION)	10
5.3 MEASUREMENT EQUIPMENT USED.....	10
5.4 CONDUCTED EMISSION LIMIT	10
5.5 MEASUREMENT RESULT	11
5.6 CONDUCTED MEASUREMENT PHOTO.....	14
6 RADIATED EMISSION TEST.....	15
6.1 MEASUREMENT PROCEDURE	15
6.2 TEST SET-UP (BLOCK DIAGRAM OF CONFIGURATION)	15
6.3 MEASUREMENT EQUIPMENT USED.....	16
6.4 RADIATED EMISSION LIMIT	16
6.5 MEASUREMENT RESULT	18
6.6 RADIATED MEASUREMENT PHOTOS.....	22
7 20DB BANDWIDTH	23
7.1 20DB BANDWIDTH LIMIT	23
7.2 TEST INSTRUMENTS.....	23
7.3 TEST PROCEDURE	23
7.4 TEST SETUP.....	23
7.5 TEST RESULT	23
8 ANTENNA APPLICATION	25
8.1 ANTENNA REQUIREMENT	25
8.2 RESULT	25



1 General Information

1.1 Product Description

Characteristics	Description
Product Name	Wireless Charging Stand
Model number	303-0079
Operation Mode	Wireless Charging
Input Rating	5V \equiv 3A, 9V \equiv 2A
Power Supply	AC120V/60Hz for adapter
Operating Frequency	110-205KHz
Wireless Charging Power	15W Max
Modulation Technique	ASK
Antenna Type	Induction coil



1.2 Related Submittal(s) / Grant(s)

This submittal(s) (test report) is intended for FCC ID: 2A45H303-0079 filing to comply with the FCC Part 15, Subpart C Rules.

1.3 Test Methodology

Both conducted and radiated testing was performed according to the procedures in ANSI C63.10 (2013). Radiated testing was performed at an antenna to EUT distance 3 meters.

1.4 Special Accessories

Not available for this EUT intended for grant.

1.5 Equipment Modifications

Not available for this EUT intended for grant.

1.6 Test Facility

Site Description
EMC Lab. : Accredited by CNAS, 2017.06.26
The certificate is valid until 2022.10.28
The Laboratory has been assessed and proved to be in compliance with
CNAS-CL01:2006 (identical to ISO/IEC 17025:2005)
The Certificate Registration Number is L6214.

Accredited by A2LA, 2018.03.15
The Certificate Number is 4422.01.

Name of Firm : Dong Guan Anci Electronic Technology Co., Ltd.
Site Location : 1-2 Floor, Building A, No.11, Headquarters 2 Road, Songshan, Lake
Hi-tech Industrial Development Zone, Dongguan City, evelopment Zone,
Dongguan City, Guangdong Pr., China.

2 System Test Configuration

2.1 EUT Configuration

The EUT configuration for testing is installed on RF field strength measurement to meet the Commissions requirement and operating in a manner which intends to maximize its emission characteristics in a continuous normal application.

2.2 EUT Exercise

The Transmitter was operated in the normal operating mode. The TX frequency was fixed which was for the purpose of the measurements.

2.3 Test Procedure

2.3.1 Conducted Emissions

The EUT is a placed on as turn table which is 0.8 m above ground plane. According to the requirements in Section 13.1.4.1 of ANSI C63.10-2013 Conducted emissions from the EUT measured in the frequency range between 0.15 MHz and 30 MHz using CISPR Quasi-Peak and average detector mode.

2.3.2 Radiated Emissions

The EUT is a placed on as turn table which is 0.8 m above ground plane. The turn table shall rotate 360 degrees to determine the position of maximum emission level. EUT is set 3m away from the receiving antenna which varied from 1m to 4m to find out the highest emission. And also, each emission was to be maximized by changing the polarization of receiving antenna both horizontal and vertical. In order to find out the max. emission, the fixed in a particular direction according to the requirements in Section 13.1.4.1 of ANSI C63.10-2013.

2.4 Configuration of Tested System

Fig. 2-1 Configuration of Tested System

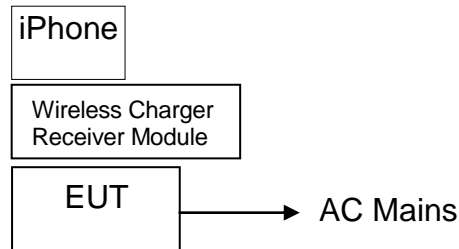

Table 2-1 Equipment Used in Tested System

Item	Equipment	Trade Mark	Model No.	FCC ID	Note
1.	Wireless Charging Stand	N/A	303-0079	2A45H303-0079	EUT
2.	Adapter	N/A	Model: PD23U-1TNA Input: AC 100-240V, 50/60Hz, 0.8A Max Output: DC 5V/3A, DC 9V/2.5A	N/A	Support EUT
3.	SAMSUNG S9	SAMSUNG	Samsung Galaxy S9	N/A	Support Equipment
4.	Xiaomi 9	MI	Xiaomi 9	N/A	Support Equipment
5.	Wireless Charging Receiver Module	Universal	N/A	N/A	Support Equipment

Note:

- (1) Unless otherwise denoted as EUT in 『Remark』 column, device(s) used in tested system is a support equipment.

3 Summary of Test Results

FCC Rules	Description Of Test	Result
§15.207	AC Power Conducted Emission	Compliant
§15.209	Radiated Emission	Compliant
§2.1049	20dB Bandwidth	Compliant
§15.203	Antenna Requirement	Compliant



4 TEST SYSTEM UNCERTAINTY

The following measurement uncertainty levels have been estimated for tests performed on the apparatus:

Parameter	Uncertainty
Conducted Emissions Test	$\pm 2.0\text{dB}$
Radiated Emission Test	$\pm 2.0\text{dB}$
Temperature	$\pm 0.5^\circ\text{C}$
Humidity	$\pm 3\%$

Remark: The coverage Factor ($k=2$), and measurement Uncertainty for a level of Confidence of 95%

5 Conducted Emissions Test

5.1 Measurement Procedure

1. The EUT was placed on a table which is 0.8m above ground plane.
2. Maximum procedure was performed on the six highest emissions to ensure EUT compliance.
3. Repeat above procedures until all frequency measured was complete.

5.2 Test SET-UP (Block Diagram of Configuration)

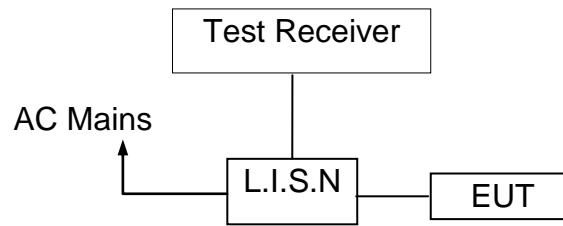

5.3 Measurement Equipment Used

EQUIPMENT TYPE	MFR	MODEL NUMBER	SERIAL NUMBER	Calibrated until
L.I.S.N	SCHWARZBECK	NSLK 8127	8127-669	2022-05-23
10 db attenuator	JFW	50FP-010-H4	4360846-427-1	2022-05-23
RF Cable	N/A	N/A	2#	2022-05-23
EMI Test Receiver	ROHDE&SCHWARZ	ESCI	101358	2022-05-23

5.4 Conducted Emission Limit

Conducted Emission Frequency(MHz)	Quasi-peak	Average
0.15-0.5	66-56	56-46
0.5-5.0	56	46
5.0-30.0	60	50

- Note:** 1. The lower limit shall apply at the transition frequencies
 2. The limit decreases in line with the logarithm of the frequency in the range of 0.15 to 0.50MHz.



5.5 Measurement Result

Operation Mode:	TX	Test Date :	2022/02/23
Frequency Range:	0.15MHz~30MHz	Temperature :	22°C
Test Result:	PASS	Humidity :	60 %
Test By:	Best		

Pass

We pretested modes (Wireless Charging(15W), Wireless Charging(10W),Wireless Charging(7.5W), Wireless Charging(5W)) for EUT. The worst test data see follow the table.



Test mode: Wireless Charging 15W

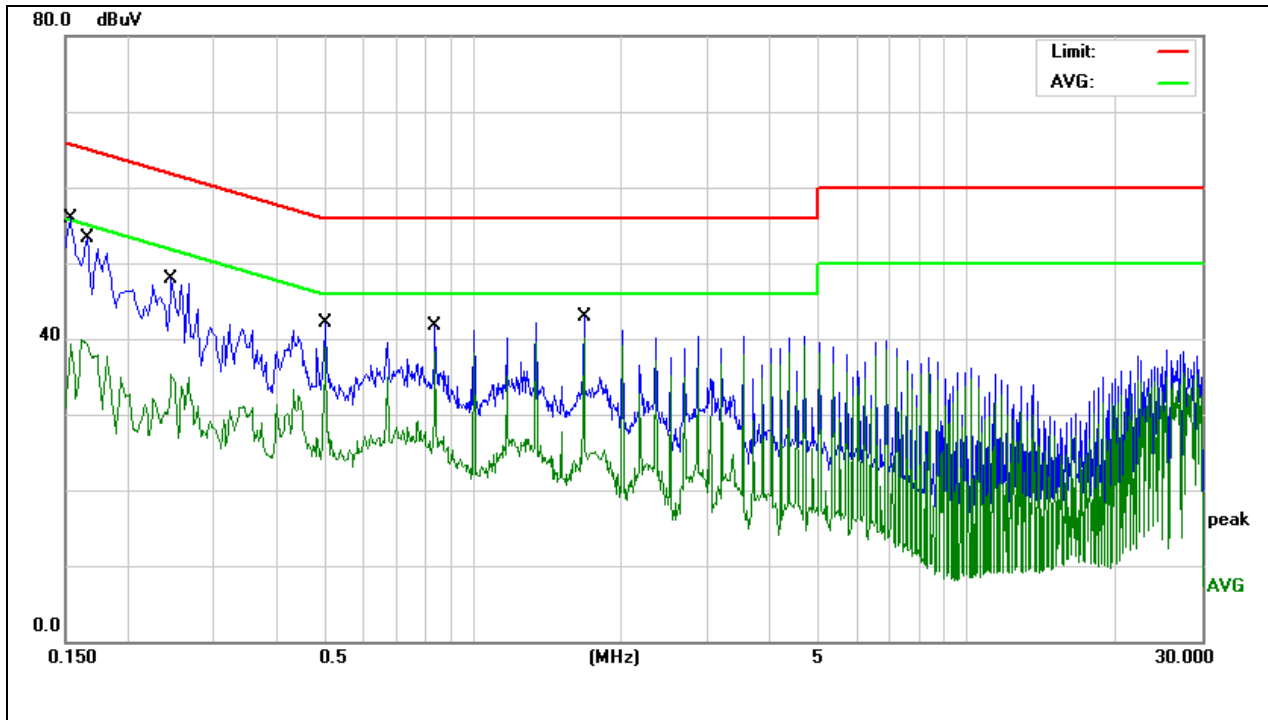

Site:	843	Phase:L1	Temperature(C):22
Limit:	FCC Part 15 C Conduction(QP)		Humidity(%RH):60
EUT:	Wireless Charging Stand	Test Time:	2022/02/23
M/N.:	303-0079	Power Rating:	AC 120V/60Hz
Mode:	Wireless Charging 15W	Test Engineer:	Jack
Note:			

No.	Frequency (MHz)	Reading Level(dBuV)	Factor (dB)	Measurement(dBuV)	Limit (dBuV)	Over (dB)	Detector	Comment
1	0.1539	40.42	10.07	50.49	65.78	-15.29	QP	
2	0.1539	29.20	10.07	39.27	55.78	-16.51	AVG	
3	0.1660	39.47	10.07	49.54	65.15	-15.61	QP	
4	0.1660	29.06	10.07	39.13	55.15	-16.02	AVG	
5	0.2460	32.48	10.08	42.56	61.89	-19.33	QP	
6	0.2460	25.15	10.08	35.23	51.89	-16.66	AVG	
7	0.5060	29.87	10.09	39.96	56.00	-16.04	QP	
8	0.5060	28.83	10.09	38.92	46.00	-7.08	AVG	
9	0.8420	29.68	10.10	39.78	56.00	-16.22	QP	
10	0.8420	28.17	10.10	38.27	46.00	-7.73	AVG	
11	1.6820	31.50	10.13	41.63	56.00	-14.37	QP	
12	1.6820	30.53	10.13	40.66	46.00	-5.34	AVG	

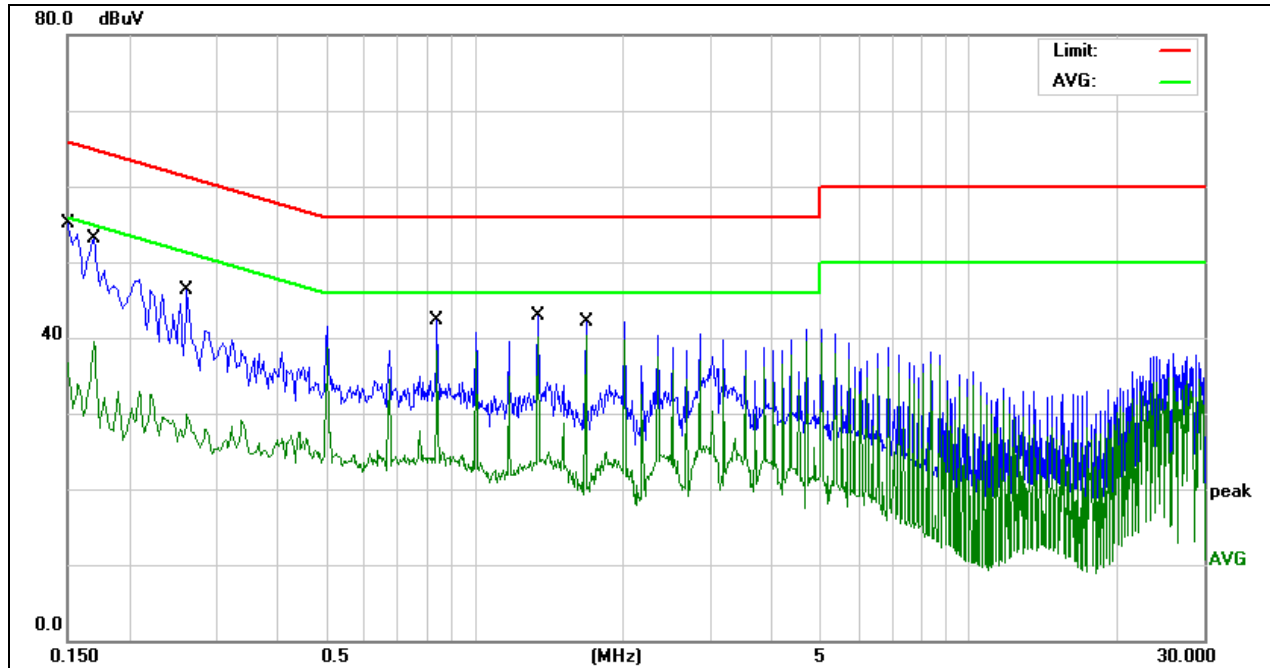

Site:	843	Phase:	N	Temperature(C):	22
Limit:	FCC Part 15 C Conduction(QP)	Humidity(%RH):	60	Test Time:	2022/02/23
EUT:	Wireless Charging Stand	Power Rating:	AC 120V/60Hz	Test Engineer:	Jack
M/N.:	303-0079				
Mode:	Wireless Charging 15W				
Note:					

No.	Frequency (MHz)	Reading Level(dBuV)	Factor (dB)	Measurement(dBuV)	Limit (dBuV)	Over (dB)	Detector	Comment
1	0.1500	40.42	10.07	50.49	65.99	-15.50	QP	
2	0.1500	24.43	10.07	34.50	55.99	-21.49	AVG	
3	0.1700	37.35	10.08	47.43	64.96	-17.53	QP	
4	0.1700	29.37	10.08	39.45	54.96	-15.51	AVG	
5	0.2620	29.65	10.07	39.72	61.36	-21.64	QP	
6	0.2620	18.69	10.07	28.76	51.36	-22.60	AVG	
7	0.8420	26.42	10.10	36.52	56.00	-19.48	QP	
8	0.8420	28.12	10.10	38.22	46.00	-7.78	AVG	
9	1.3460	30.72	10.12	40.84	56.00	-15.16	QP	
10	1.3460	29.88	10.12	40.00	46.00	-6.00	AVG	
11	1.6820	31.17	10.13	41.30	56.00	-14.70	QP	
12	1.6820	30.53	10.13	40.66	46.00	-5.34	AVG	

5.6 Conducted Measurement Photo



6 Radiated Emission Test

6.1 Measurement Procedure

1. The EUT was placed on a turn table which is 0.8m above ground plane.
2. Maximum procedure was performed on the six highest emissions to ensure EUT compliance.
3. And also, each emission was to be maximized by changing the polarization of receiving antenna both horizontal and vertical.
4. Repeat above procedures until all frequency measured were complete.

6.2 Test SET-UP (Block Diagram of Configuration)

(A) Radiated Emission Test Set-Up, Frequency Below 30MHz

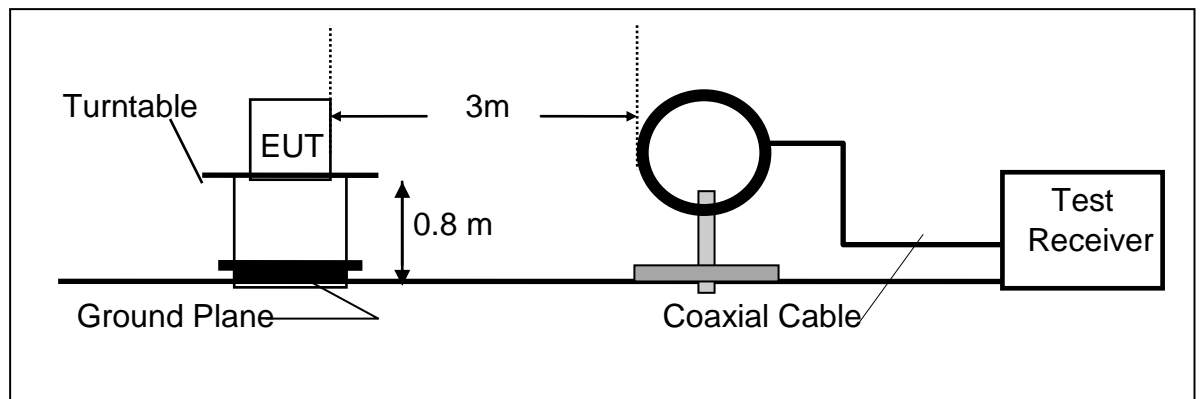

(B) Radiated Emission Test Set-Up, Frequency Below 1000MHz

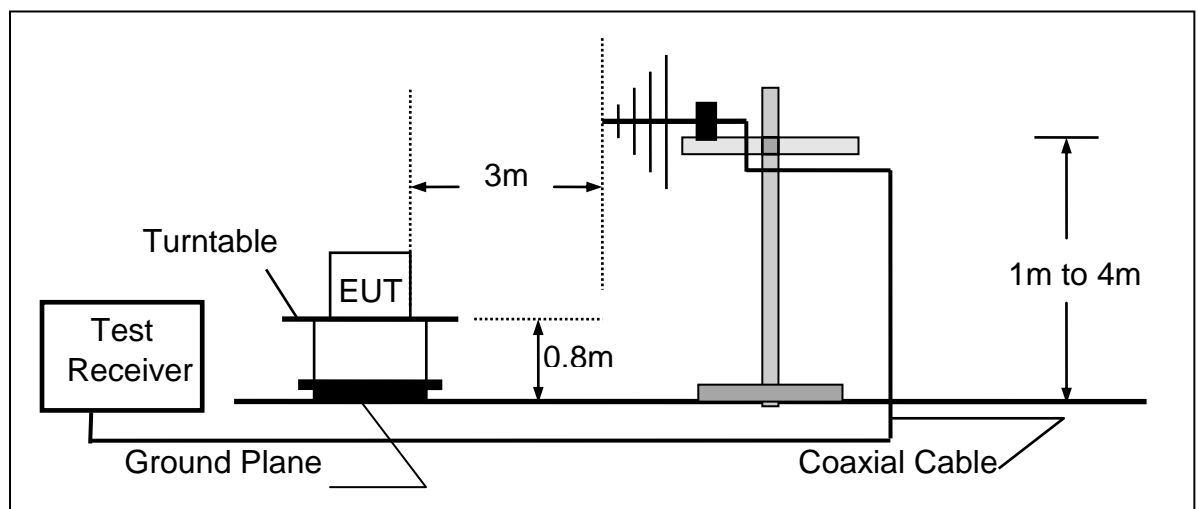



6.3 Measurement Equipment Used

Item	Equipment	Manufacturer	Model No.	Serial No.	Calibrated until
1.	EMI Test Receiver	Rohde & Schwarz	ESPI	100502	2022/11/19
2.	Pre-Amplifier	HP	8447D	2727A06172	2022-05-23
3.	Bilog Antenna	Schwarzbeck	VULB9163	VULB9163-588	2022-05-23
4.	Loop Antenna	Schwarzbeck	FMZB 1516	1516-141	2022/11/19
5.	RF Cable	Gigalink Microwave	ZT40-2.92J-2.92 J-2m	N/A	2022/11/19
6.	RF Cable	Gigalink Microwave	ZT40-2.92J-2.92 J-0.3m	N/A	2022/11/19
7.	RF Cable	N/A	N/A	6#	2022-05-23
8.	3m Semi-anechoic Chamber	chengyu	9m*6m*6m	N/A	2022-05-23
9.	Test Software	Farad	EZ-EMC Ver:ANCI-3A1	N/A	N/A

6.4 Radiated Emission Limit

The emissions from an intentional radiator shall not exceed the field strength levels specified in the following table 15.209(a):

FCC Part 15.209				
Frequency (MHz)	Field Strength Limitation		Field Strength Limitation Frequency tion at 3m Measurement Dist	
	(uV/m)	Dist	(uV/m)	(dBuV/m)
0.009 – 0.490	$2400 / F(\text{KHz})$	300m	$10000 * 2400/F(\text{KHz})$	$20\log 2400/F(\text{KHz}) + 80$
0.490 – 1.705	$24000 / F(\text{KHz})$	30m	$100 * 24000/F(\text{KHz})$	$20\log 24000/F(\text{KHz}) + 40$
1.705 – 30.00	30	30m	$100 * 30$	$20\log 30 + 40$
30.0 – 88.0	100	3m	100	$20\log 100$
88.0 – 216.0	150	3m	150	$20\log 150$
216.0 – 960.0	200	3m	200	$20\log 200$
Above 960.0	500	3m	500	$20\log 500$



15.205 Restricted bands of operation

MHz	MHz	MHz	GHz
0.090 - 0.110	16.42 - 16.423	399.9 - 410	4.5 - 5.15
¹ 0.495 - 0.505	16.69475 - 16.69525	608 - 614	5.35 - 5.46
2.1735 - 2.1905	16.80425 - 16.80475	960 - 1240	7.25 - 7.75
4.125 - 4.128	25.5 - 25.67	1300 - 1427	8.025 - 8.5
4.17725 - 4.17775	37.5 - 38.25	1435 - 1626.5	9.0 - 9.2
4.20725 - 4.20775	73 - 74.6	1645.5 - 1646.5	9.3 - 9.5
6.215 - 6.218	74.8 - 75.2	1660 - 1710	10.6 - 12.7
6.26775 - 6.26825	108 - 121.94	1718.8 - 1722.2	13.25 - 13.4
6.31175 - 6.31225	123 - 138	2200 - 2300	14.47 - 14.5
8.291 - 8.294	149.9 - 150.05	2310 - 2390	15.35 - 16.2
8.362 - 8.366	156.52475 - 156.52525	2483.5 - 2500	17.7 - 21.4
8.37625 - 8.38675	156.7 - 156.9	2690 - 2900	22.01 - 23.12
8.41425 - 8.41475	162.0125 - 167.17	3260 - 3267	23.6 - 24.0
12.29 - 12.293	167.72 - 173.2	3332 - 3339	31.2 - 31.8
12.51975 - 12.52025	240 - 285	3345.8 - 3358	36.43 - 36.5
12.57675 - 12.57725	322 - 335.4	3600 - 4400	(²)

- Remark:
1. Emission level in dBuV/m=20 log (uV/m)
 2. Measurement was performed at an antenna to the closed point of EUT distance of meters.
 3. Only spurious frequency is permitted to locate within the Restricted Bands specified in provision of ξ 15.205, and the emissions located in restricted bands also comply with 15.209 limit.

6.5 Measurement Result

We pretested modes (Wireless Charging(15W), Wireless Charging(10W), Wireless Charging(7.5W), Wireless Charging(5W)) for EUT. The worst mode (Wireless Charging(15W)) test data see follow the table.



Site:	LAB	Antenna::	Vertical	Temperature(C):	23.4(C)
Limit:	FCC Part 15C 3m Radiation(QP)	Test Time:	2022/02/23	Humidity(%):	56.7%
EUT:	Wireless Charging Stand	Power Rating:	AC 120V/60Hz	Test Engineer:	sunshine
M/N.:	303-0079				
Mode:	Wireless Charging 15W				
Note:					

No.	Frequency (MHz)	Reading (dBuV)	Factor (dB/m)	Level (dBuV/m)	Limit (dBuV/m)	Margin (dB)	Det.	Height (cm)	Azimuth (deg)	Remark
1	0.3259	70.45	5.80	76.25	97.32	-21.07	QP	100	74	
2 *	0.6491	51.82	6.44	58.26	71.36	-13.10	QP	100	125	
3	0.9800	46.54	6.08	52.62	67.80	-15.18	QP	100	36	
4	1.3080	46.02	6.13	52.15	65.30	-13.15	QP	100	74	
5	2.2835	37.21	6.33	43.54	69.50	-25.96	QP	100	101	
6	14.7522	41.67	6.93	48.60	69.50	-20.90	QP	100	123	

*:Maximum data x:Over limit !:over margin

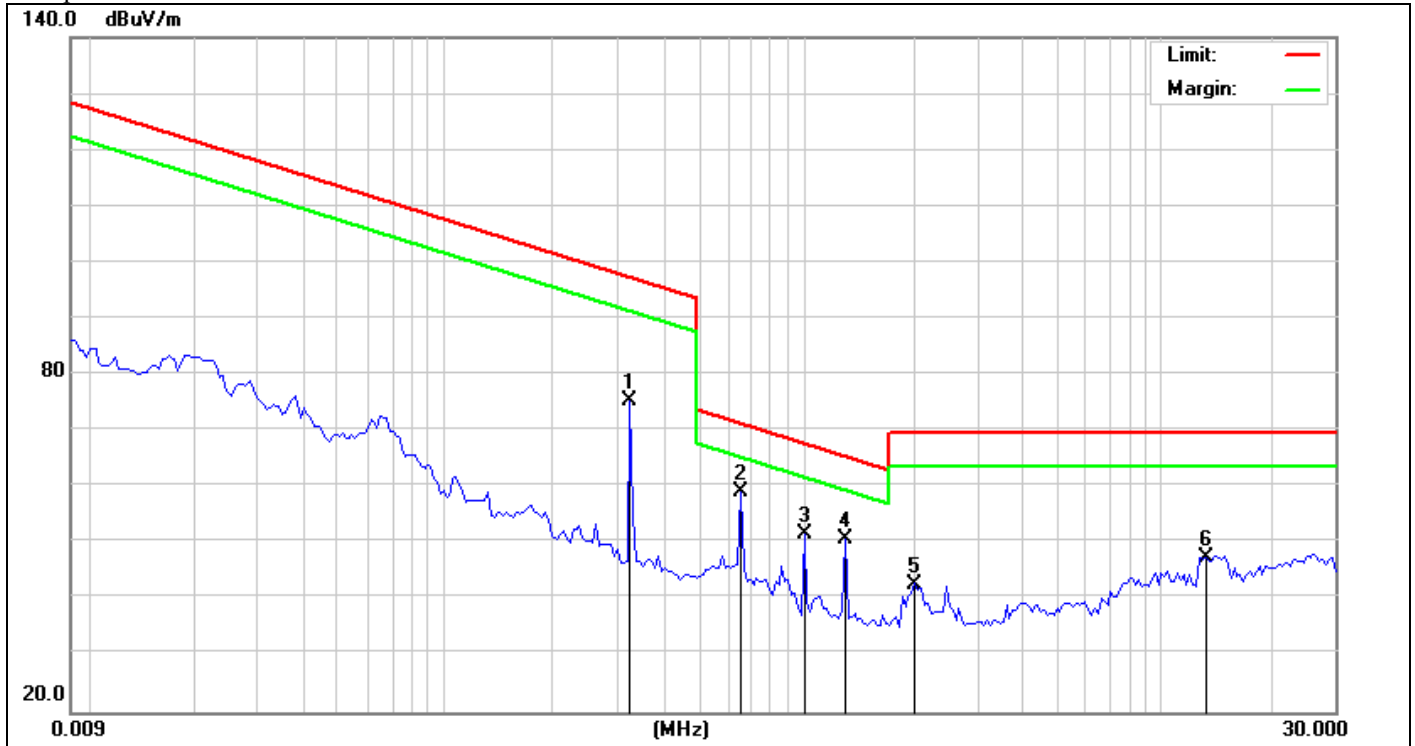

Site:	LAB	Antenna::	Horizontal	Temperature(C):	23.4(C)
Limit:	FCC Part 15C 3m Radiation(QP)			Humidity(%):	56.7%
EUT:	Wireless Charging Stand	Test Time:			2022/02/23
M/N.:	303-0079	Power Rating:			AC 120V/60Hz
Mode:	Wireless Charging 15W	Test Engineer:			sunshine
Note:					

No.	Frequency (MHz)	Reading (dBuV)	Factor (dB/m)	Level (dBuV/m)	Limit (dBuV/m)	Margin (dB)	Det.	Height (cm)	Azimuth (deg)	Remark
1	0.3259	69.45	5.80	75.25	97.32	-22.07	QP	100	74	
2 *	0.6601	52.65	6.45	59.10	71.22	-12.12	QP	100	125	
3	0.9801	45.63	6.08	51.71	67.79	-16.08	QP	100	36	
4	1.3051	44.59	6.13	50.72	65.31	-14.59	QP	100	74	
5	2.0219	36.44	6.36	42.80	69.50	-26.70	QP	100	101	
6	13.0625	40.73	6.76	47.49	69.50	-22.01	QP	100	123	

- Note:**
- (1) All Readings are Peak Value.
 - (2) Emission Level= Reading Level+Probe Factor +Cable Loss.
 - (3) The average measurement was not performed when the peak measured data under the limit of average detection.
 - (4) EUT lying on the table position is the worst case result in the report.



Report No.: E01A22020118F00101

20 of 29

We pretested modes (Wireless Charging(15W),Wireless Charging(10W),Wireless Charging(7.5W), Wireless Charging(5W)) for EUT. The worst test data see follow the table.

Test mode: Wireless Charging 15W

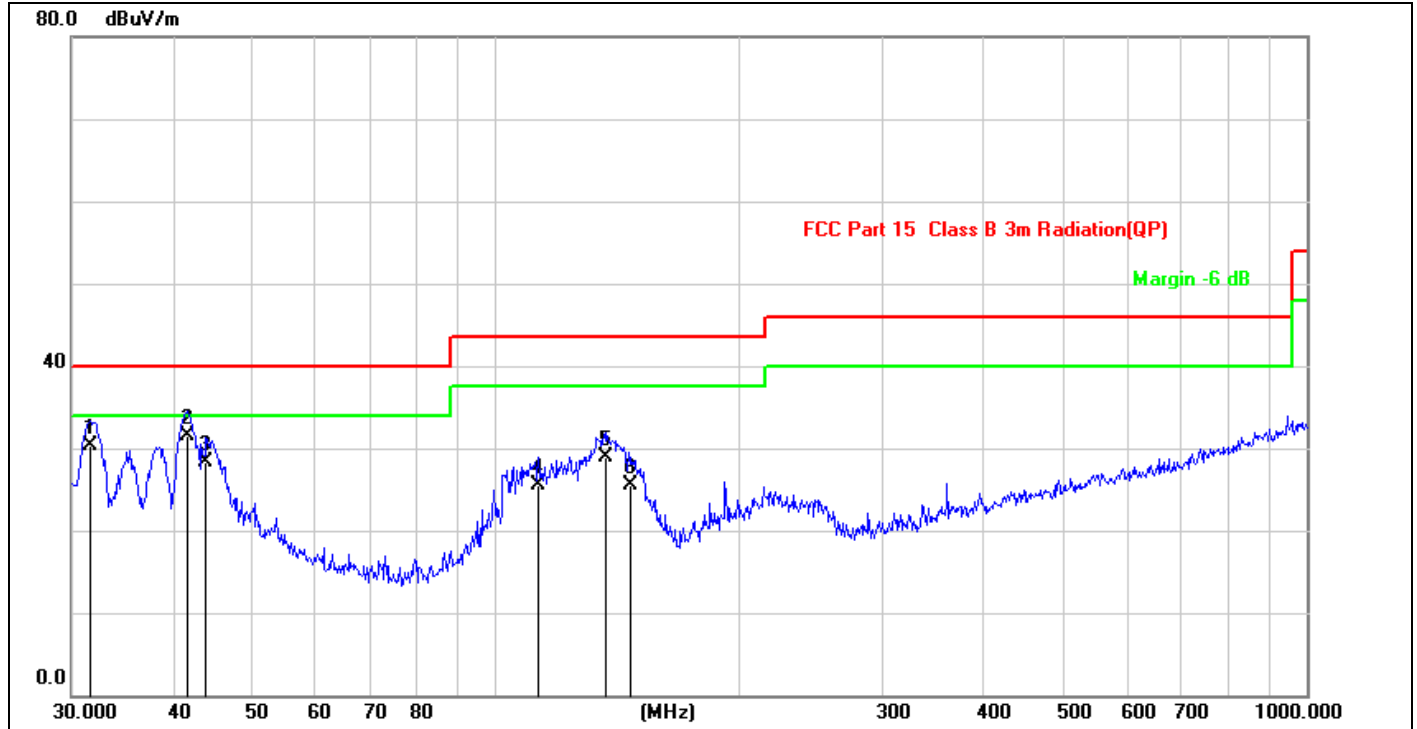

Site:	LAB	Antenna::	Vertical	Temperature(C):	23.4(C)
Limit:	FCC Part 15 Class B 3m Radiation(QP)	Test Time:	2022/02/23	Humidity(%):	56.7%
EUT:	Wireless Charging Stand	Power Rating:	AC 120V/60Hz	Test Engineer:	sunshine
M/N.:	303-0079				
Mode:	Wireless Charging 15W				
Note:					

No.	Frequency (MHz)	Reading (dBuV)	Factor (dB/m)	Level (dBuV/m)	Limit (dBuV/m)	Margin (dB)	Det.	Height (cm)	Azimuth (deg)	Remark
1	31.6202	44.88	-14.52	30.36	40.00	-9.64	QP	100	66	
2	41.7129	44.41	-13.00	31.41	40.00	-8.59	QP	100	66	
3	43.9658	41.00	-12.67	28.33	40.00	-11.67	QP	100	131	
4	112.9196	37.82	-12.37	25.45	43.50	-18.05	QP	100	131	
5	136.4598	43.51	-14.67	28.84	43.50	-14.66	QP	100	89	
6 *	146.8876	40.31	-14.86	25.45	43.50	-18.05	QP	100	89	

*:Maximum data x:Over limit !:over margin

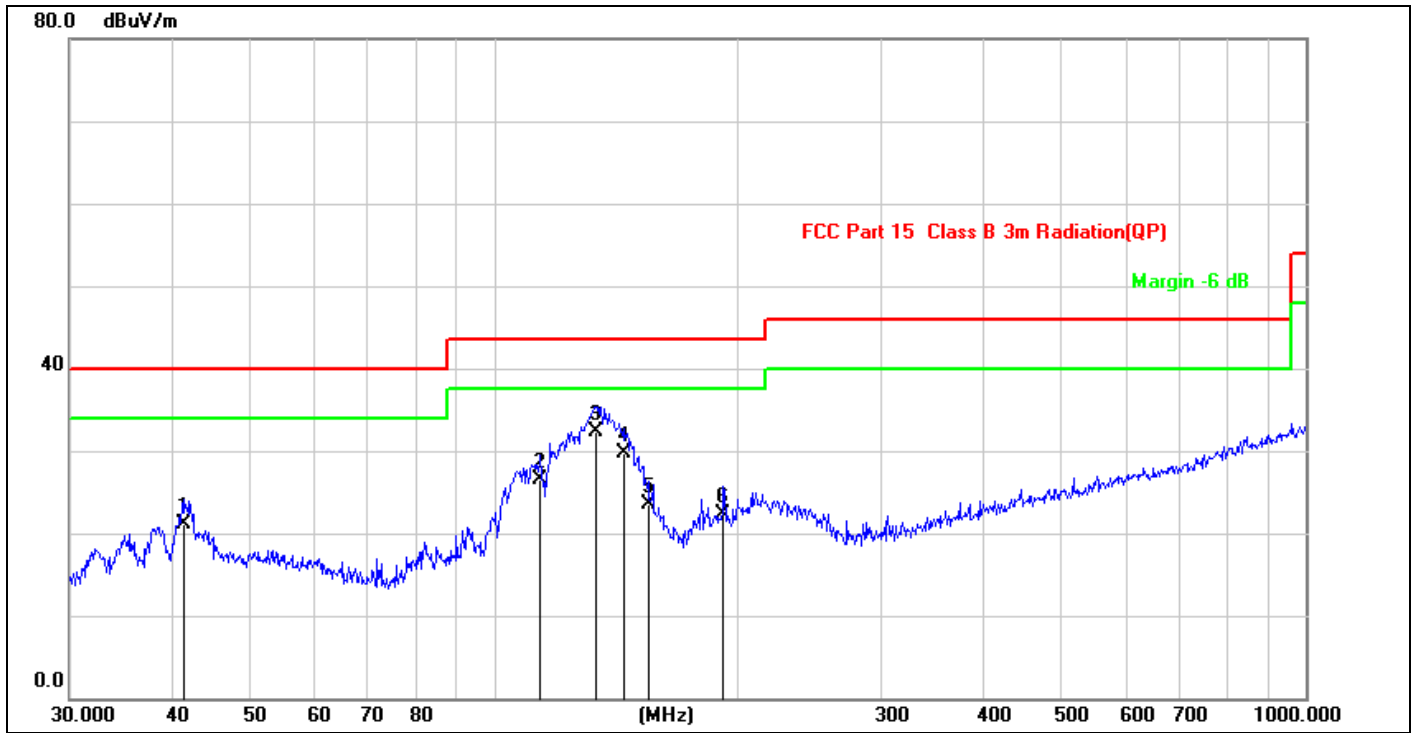

Site:	LAB	Antenna::	Horizontal	Temperature(C):	23.4(C)
Limit:	FCC Part 15 Class B 3m Radiation(QP)	Test Time:		Humidity(%):	56.7%
EUT:	Wireless Charging Stand	Power Rating:		Test Engineer:	sunshine
M/N.:	303-0079				
Mode:	Wireless Charging 15W				
Note:					

No.	Frequency (MHz)	Reading (dBuV)	Factor (dB/m)	Level (dBuV/m)	Limit (dBuV/m)	Margin (dB)	Det.	Height (cm)	Azimuth (deg)	Remark
1	41.4215	34.20	-13.04	21.16	40.00	-18.84	QP	100	41	
2	114.1138	39.01	-12.58	26.43	43.50	-17.07	QP	100	41	
3	133.6188	46.90	-14.56	32.34	43.50	-11.16	QP	100	27	
4	144.3348	44.46	-14.84	29.62	43.50	-13.88	QP	100	27	
5 *	154.8204	38.25	-14.73	23.52	43.50	-19.98	QP	100	95	
6	191.7450	33.88	-11.54	22.34	43.50	-21.16	QP	100	95	

6.6 Radiated Measurement Photos

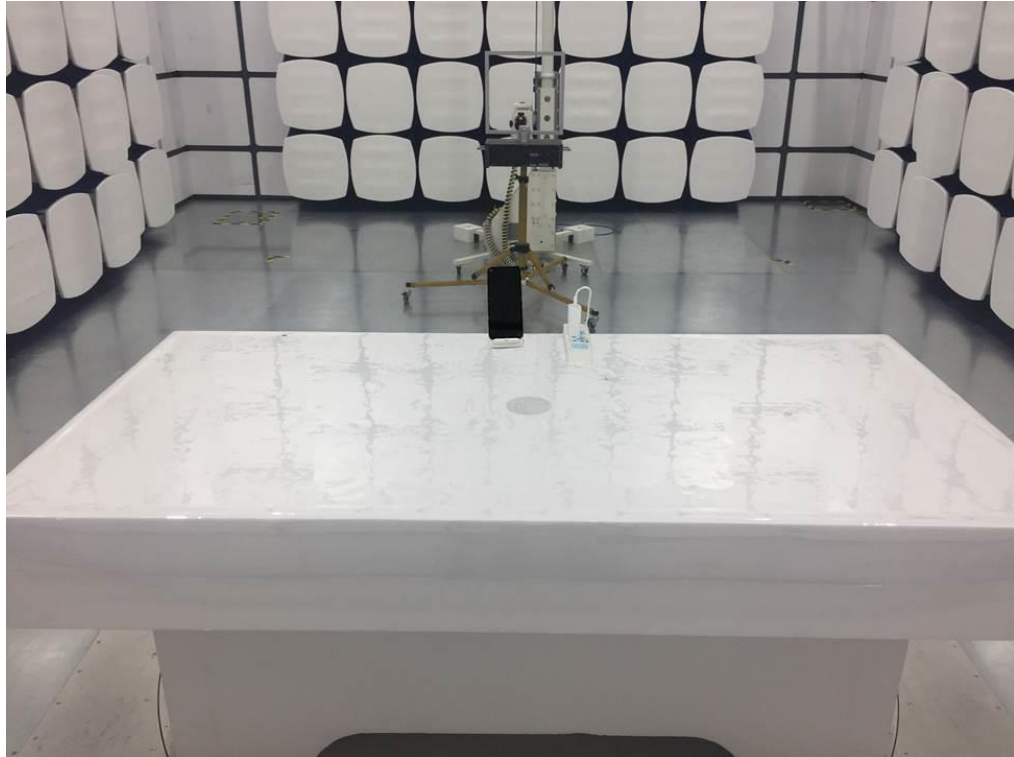

7 20db Bandwidth

7.1 20dB Bandwidth Limit

None: for reporting purposed only.

7.2 Test Instruments

Refer a test equipment and calibration data table in this test report.

7.3 Test Procedure

The bandwidth of the fundamental frequency was measured by spectrum analyzer with 1KHz RBW and 3KHz VBW. The 20dB bandwidth is defined as the total spectrum the power of which is higher than peak power minus 20dB.

7.4 Test Setup

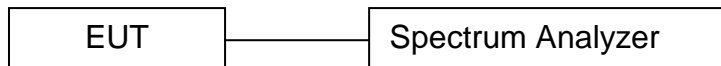

7.5 Test Result

Frequency (KHz)	20dB Bandwidth (KHz)	Results
129.279	2.533	PASS

20 dB Bandwidth Test plot

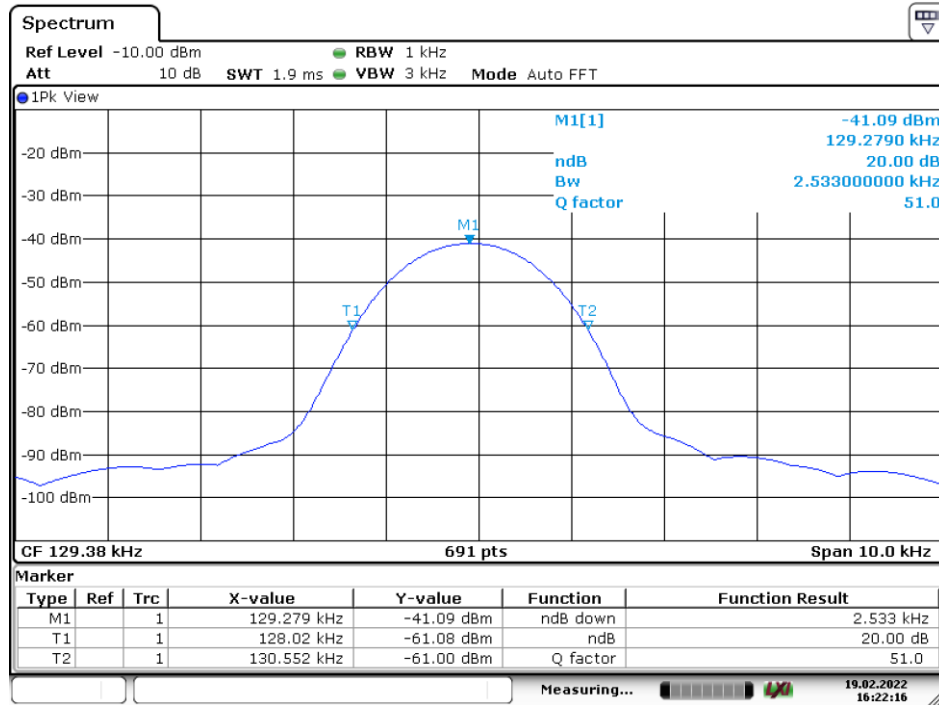

Date: 19.FEB.2022 16:22:16



8 Antenna Application

8.1 Antenna requirement

For intentional device, according to FCC 47 CFR Section 15.203, an intentional radiator shall be designed to ensure that no antenna other than that furnished by the responsible party shall be used with the device.

8.2 Result

The EUT's antenna, permanent attached antenna, used an Induction coil and integrated on PCB, The antenna's gain meets the requirement.



APPENDIX (Photos of EUT)

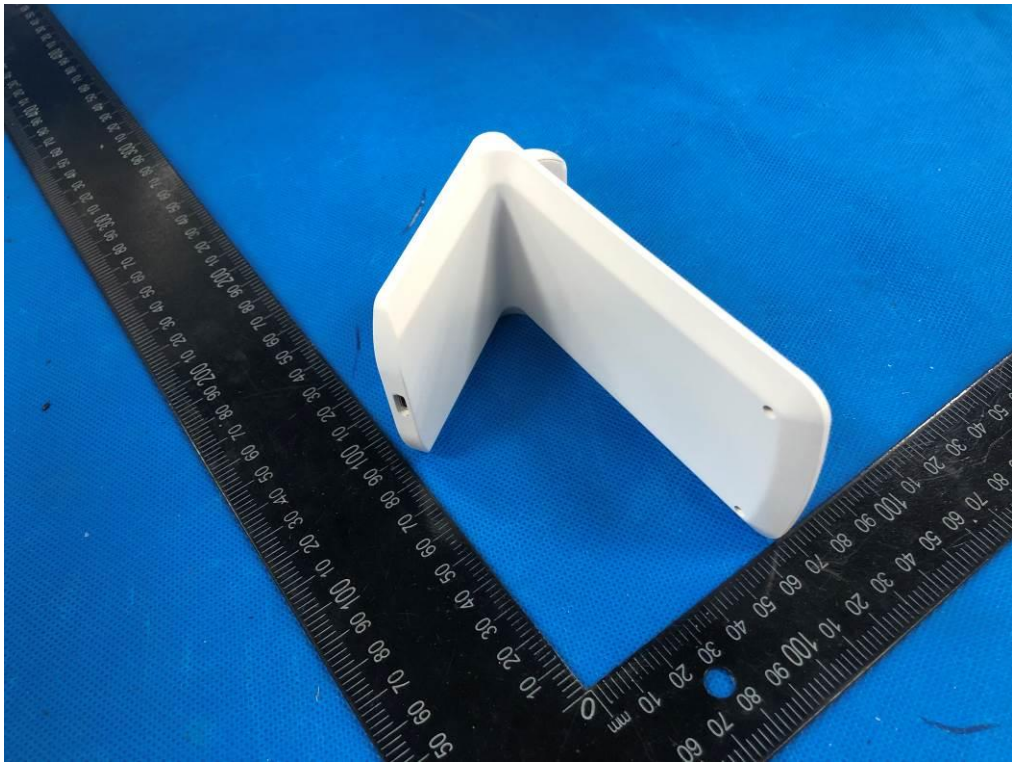
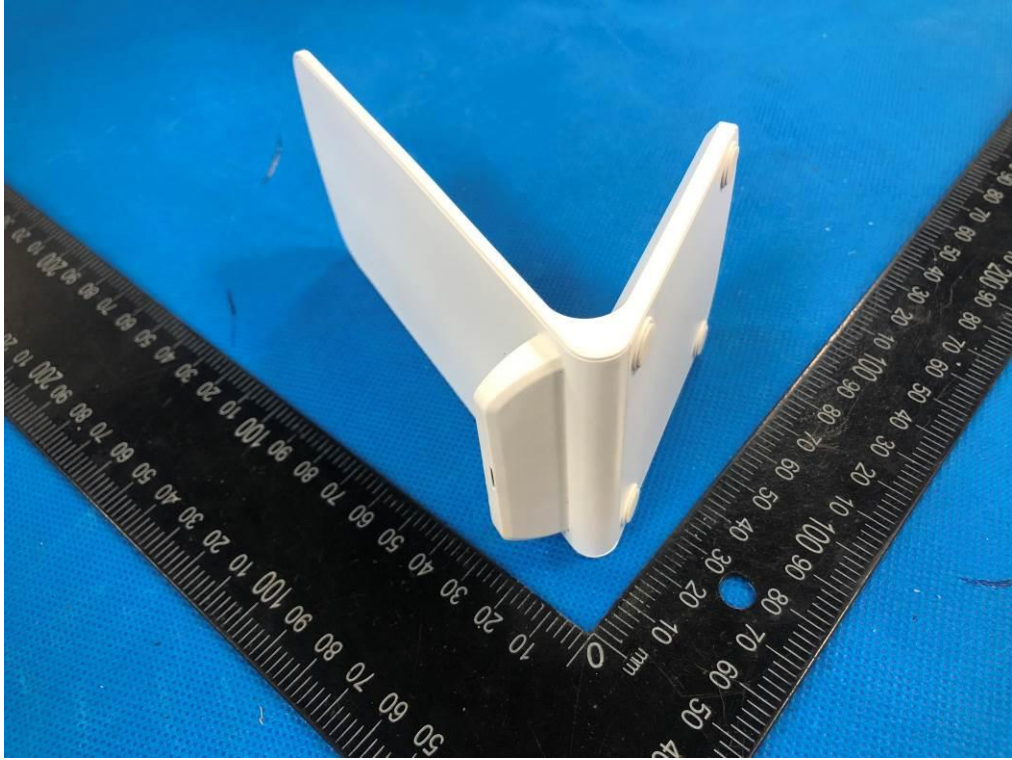

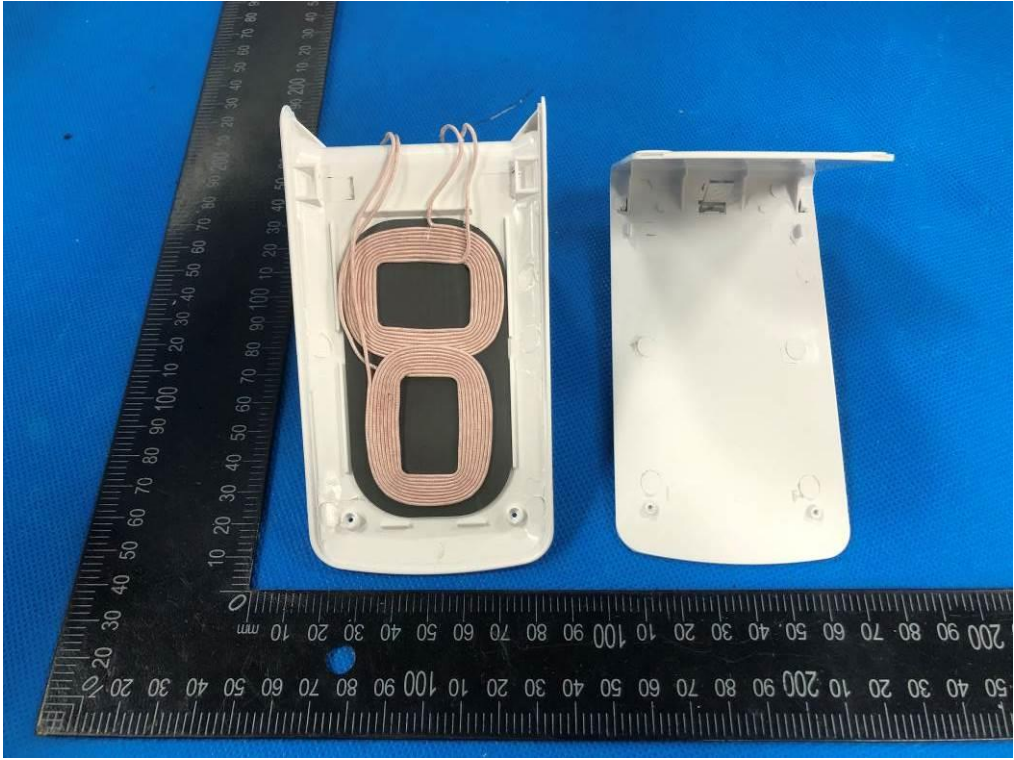

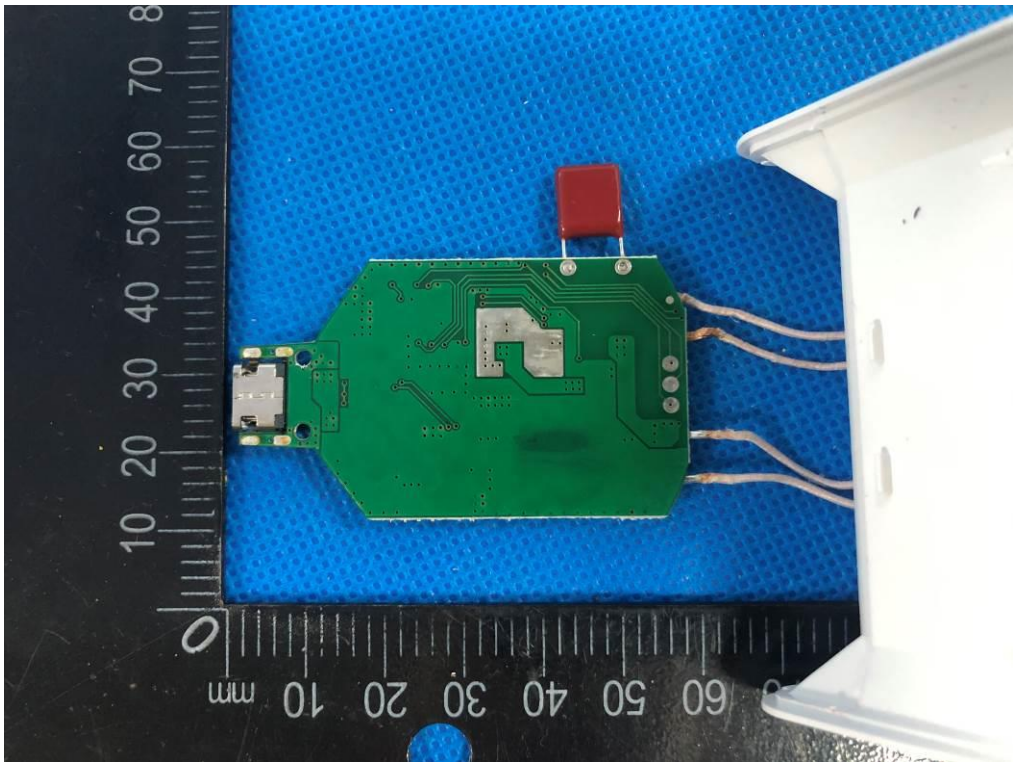
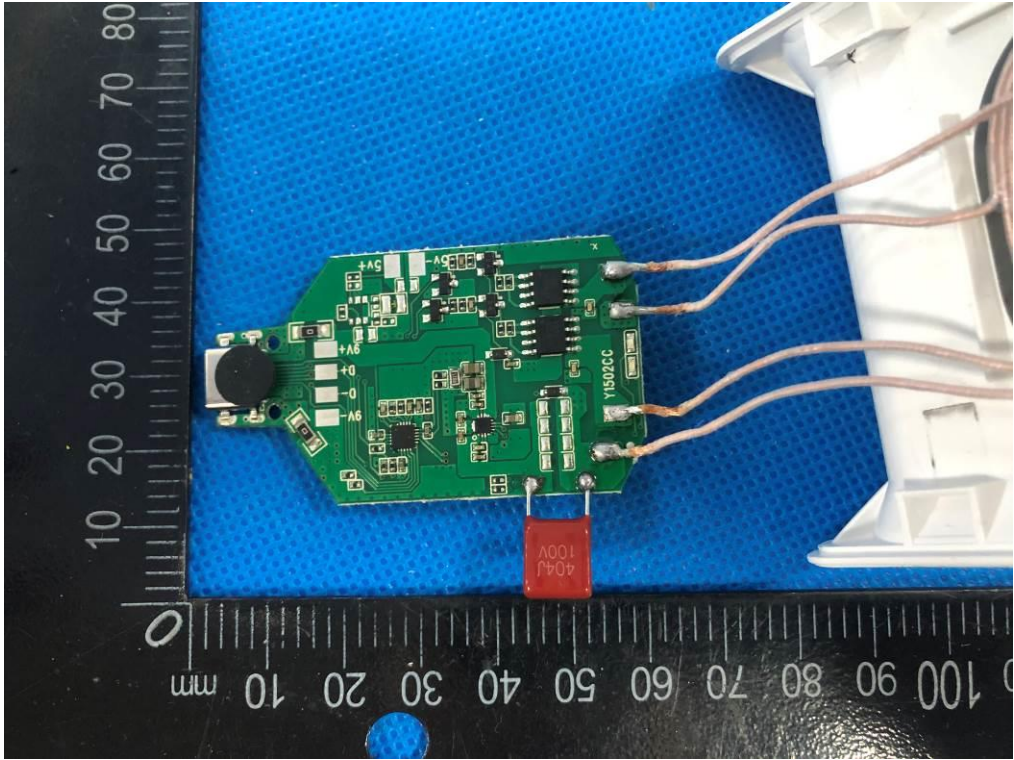

-----The end-----