

Appendix Test Data

Report No.:	18220WC40067201	Test Sample No.:	1-2-2
Start Test Date:	2024.4.08	Finish Test Date:	2024.4.08
Test Engineer:	<i>Joker Wang</i>	Auditor:	<i>Justin Feng</i>
Temperature:	25.5°C	Relative Humidity:	47%
Pressure:	101kPa		

Appendix A: -20dB Bandwidth

Condition	Antenna	Modulation	Frequency (MHz)	-20dB BW(MHz)	if larger than CFS
NVNT	ANT1	1-DH5	2402.00	0.965	No
NVNT	ANT1	1-DH5	2441.00	0.962	No
NVNT	ANT1	1-DH5	2480.00	0.947	No
NVNT	ANT1	2-DH5	2402.00	1.316	Yes
NVNT	ANT1	2-DH5	2441.00	1.316	Yes
NVNT	ANT1	2-DH5	2480.00	1.316	Yes
NVNT	ANT1	3-DH5	2402.00	1.292	Yes
NVNT	ANT1	3-DH5	2441.00	1.289	Yes
NVNT	ANT1	3-DH5	2480.00	1.292	Yes

-20dB_Bandwidth_NVNT_ANT1_1-DH5_2402

Shenzhen Anbotek Compliance Laboratory Limited

Address: 1/F., Building D, Sogood Science and Technology Park, Sanwei Community,
Hangcheng Street, Bao'an District, Shenzhen, Guangdong, China.
Tel: (86) 0755-26066440 Fax: (86) 0755-26014772 Email: service@anbotek.com



Hotline
400-003-0500
www.anbotek.com.cn



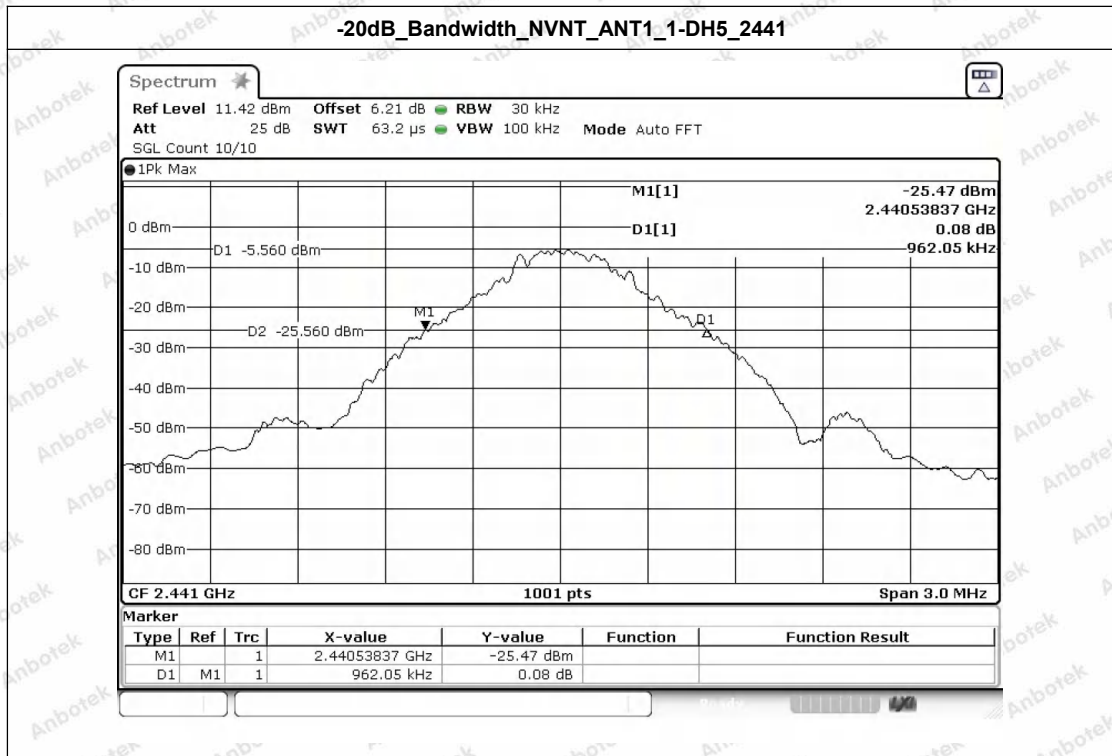
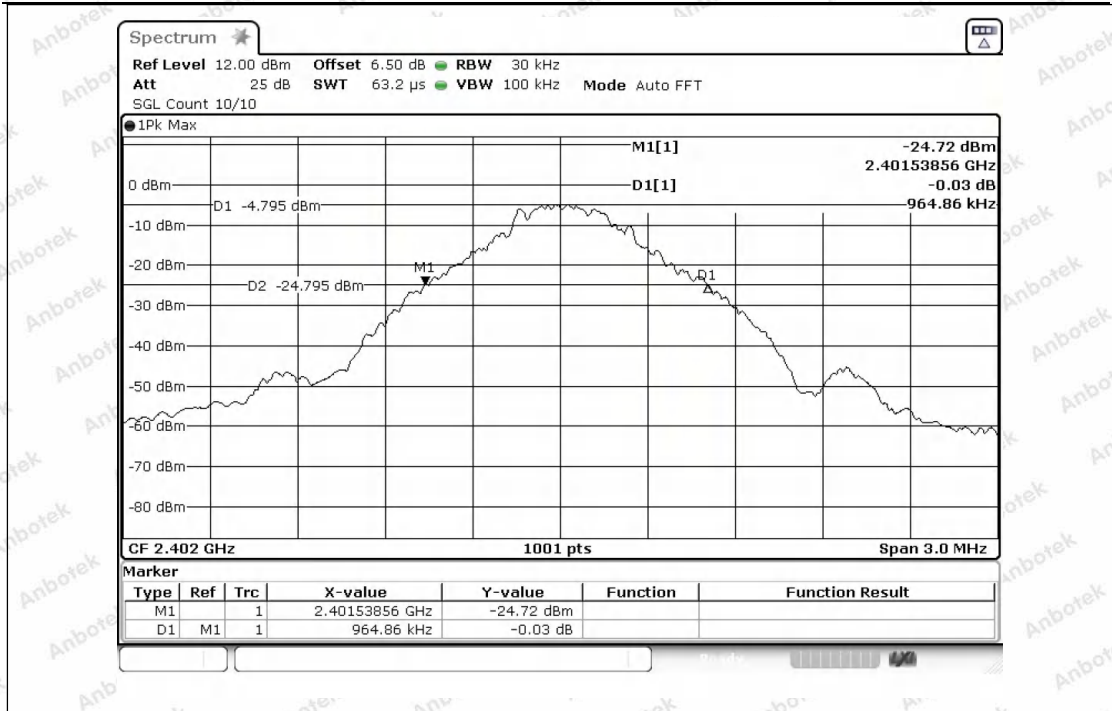

-20dB_Bandwidth_NVNT_ANT1_1-DH5_2480



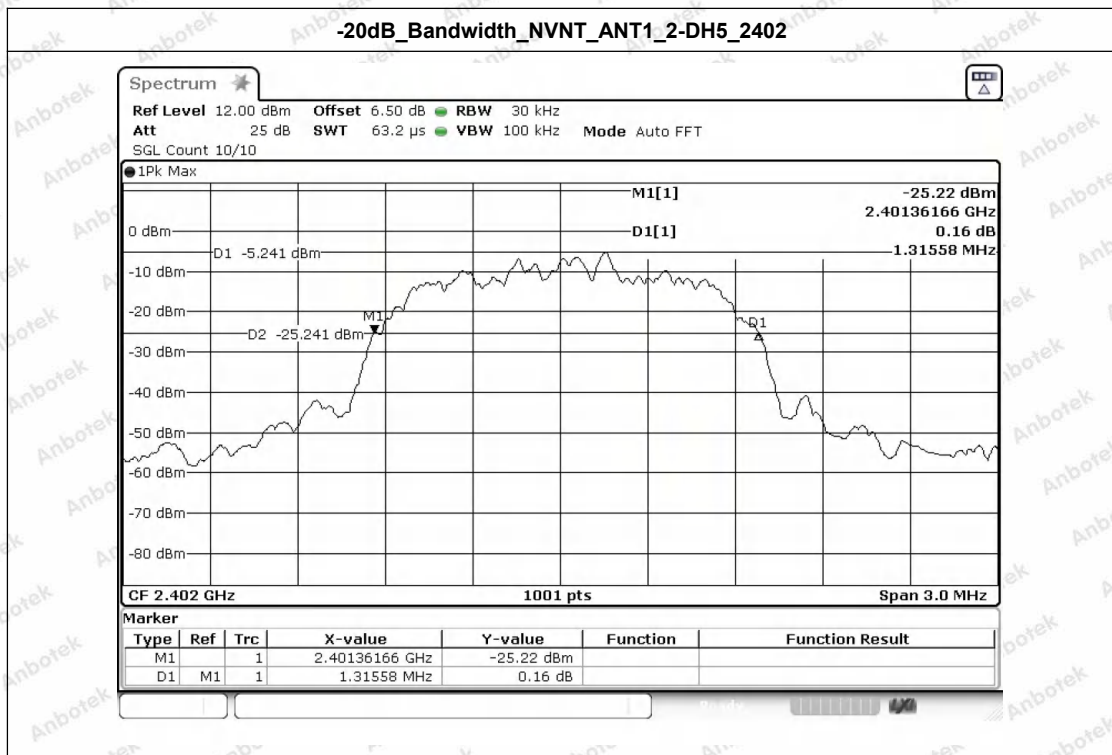
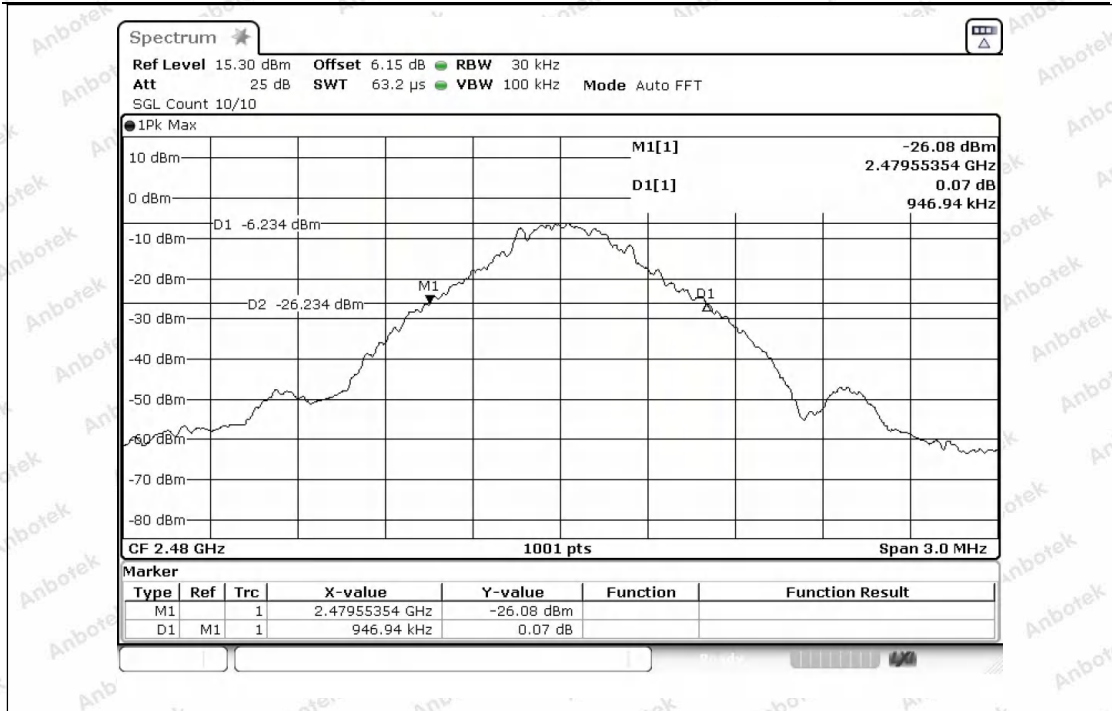

-20dB_Bandwidth_NVNT_ANT1_2-DH5_2441

Shenzhen Anbotek Compliance Laboratory Limited

Address: 1/F., Building D, Sogood Science and Technology Park, Sanwei Community, Hangcheng Street, Bao'an District, Shenzhen, Guangdong, China.
 Tel: (86) 0755-26066440 Fax: (86) 0755-26014772 Email: service@anbotek.com

Hotline
 400-003-0500
 www.anbotek.com.cn



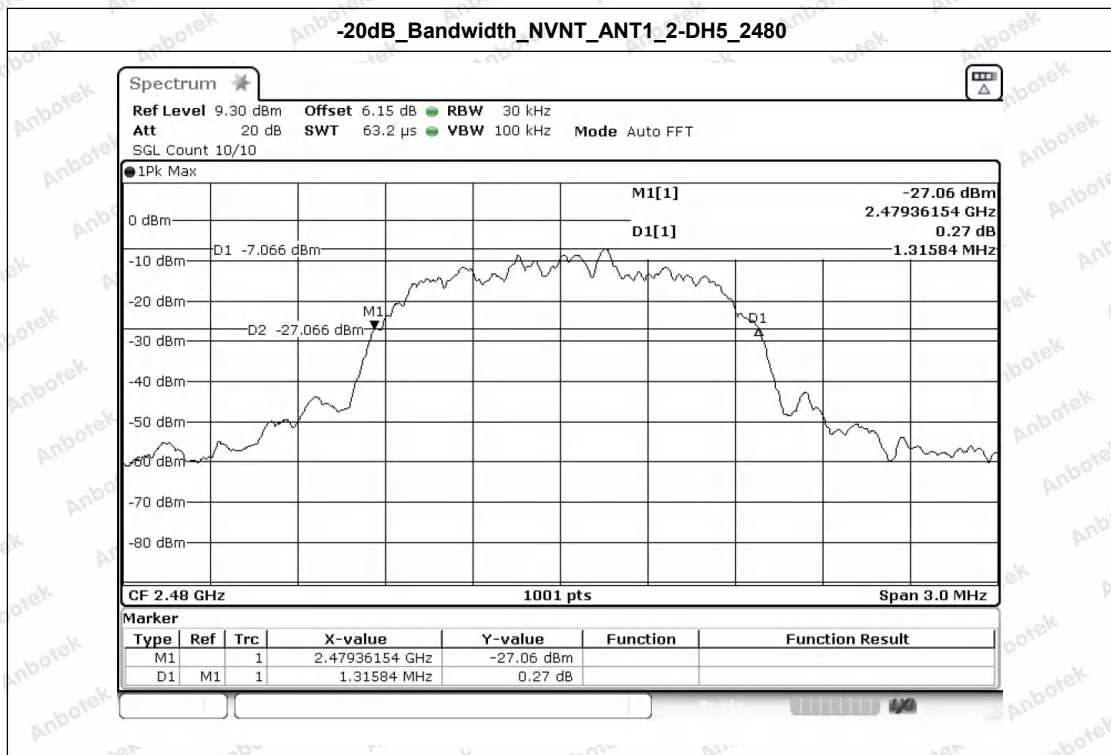
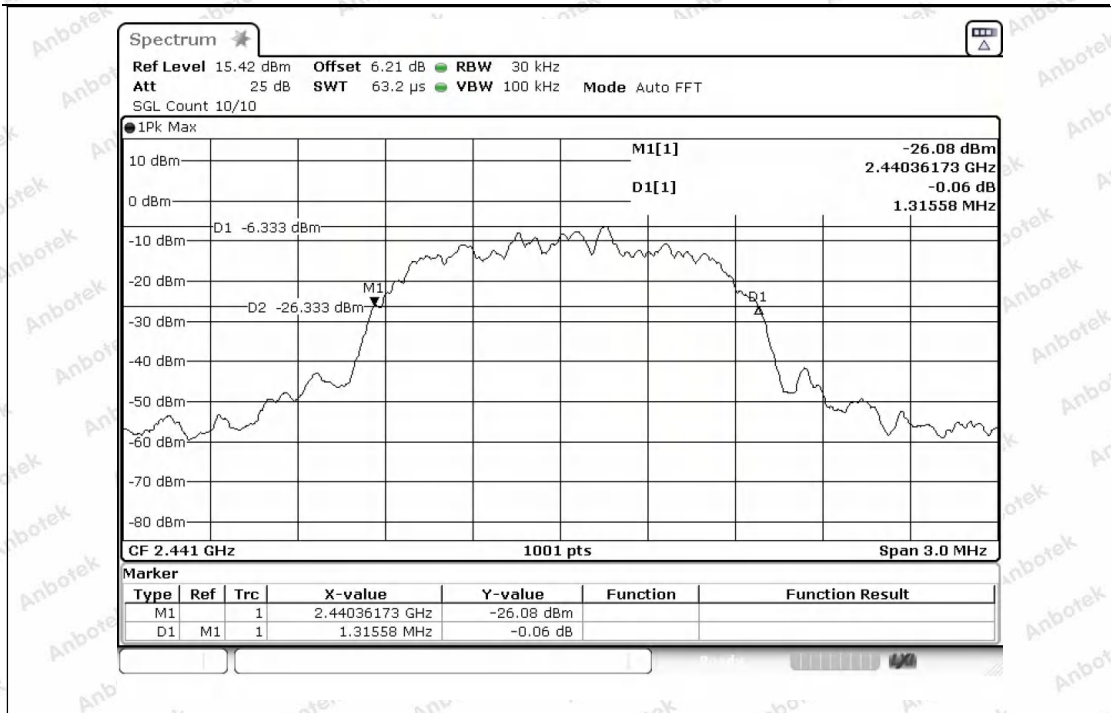

-20dB_Bandwidth_NVNT_ANT1_3-DH5_2402



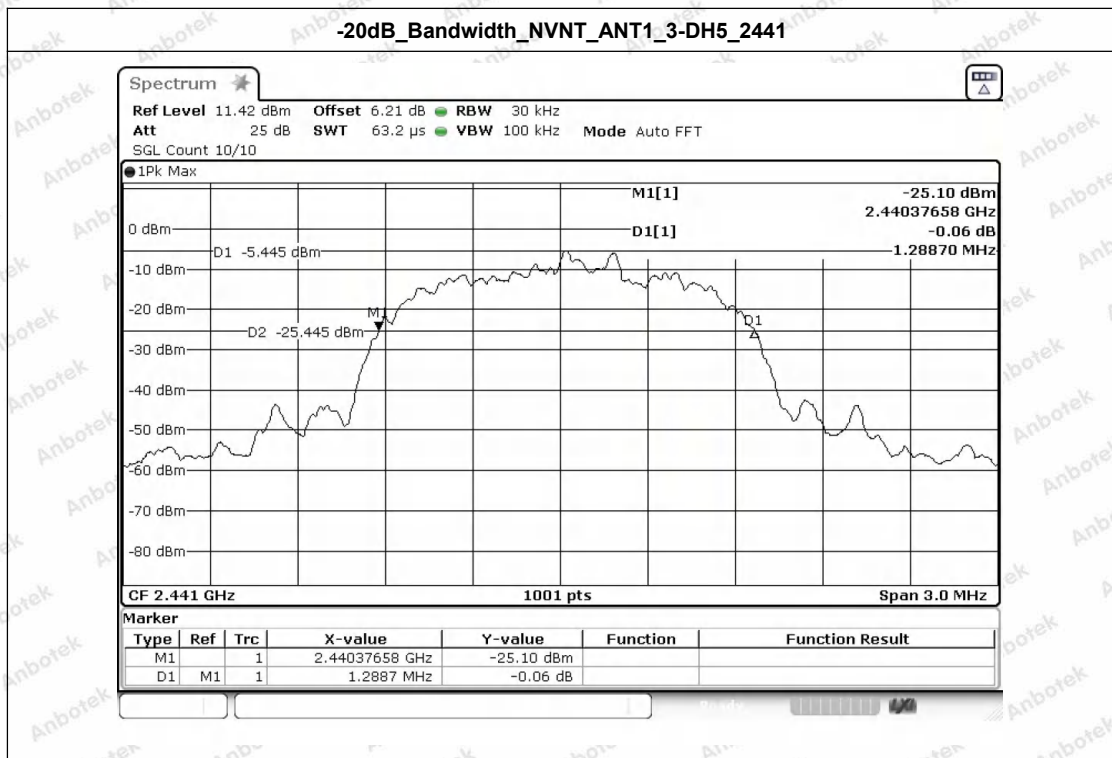
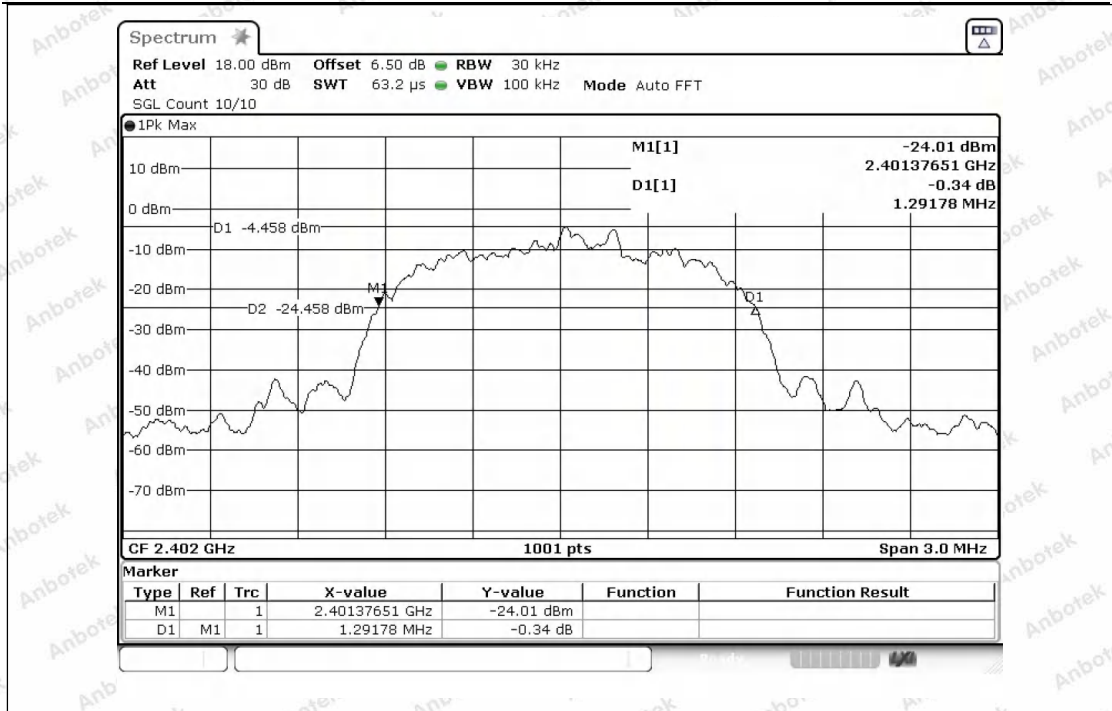

-20dB_Bandwidth_NVNT_ANT1_3-DH5_2480



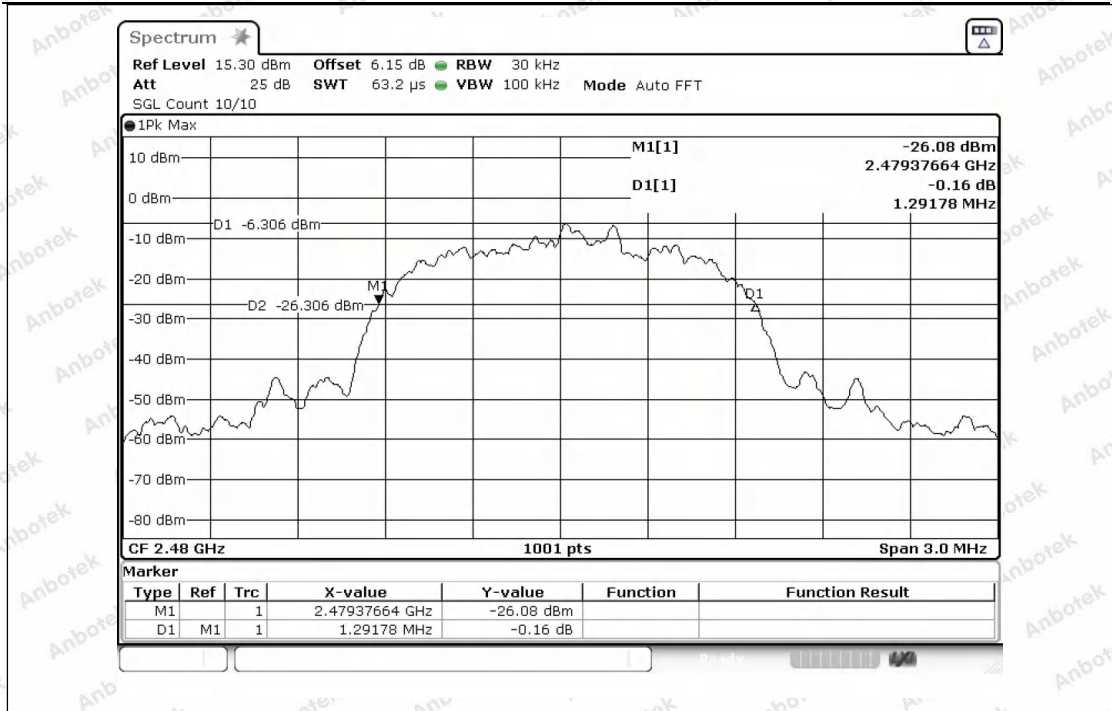

Shenzhen Anbotek Compliance Laboratory Limited

Address: 1/F., Building D, Sogood Science and Technology Park, Sanwei Community, Hangcheng Street, Bao'an District, Shenzhen, Guangdong, China.
 Tel: (86) 0755-26066440 Fax: (86) 0755-26014772 Email: service@anbotek.com



Hotline
 400-003-0500
 www.anbotek.com.cn



Appendix B: 99% Occupied Bandwidth

Condition	Antenna	Modulation	Frequency (MHz)	99% BW (MHz)
NVNT	ANT1	1-DH5	2402.00	0.851
NVNT	ANT1	1-DH5	2441.00	0.848
NVNT	ANT1	1-DH5	2480.00	0.851
NVNT	ANT1	2-DH5	2402.00	1.169
NVNT	ANT1	2-DH5	2441.00	1.169
NVNT	ANT1	2-DH5	2480.00	1.169
NVNT	ANT1	3-DH5	2402.00	1.172
NVNT	ANT1	3-DH5	2441.00	1.166
NVNT	ANT1	3-DH5	2480.00	1.166

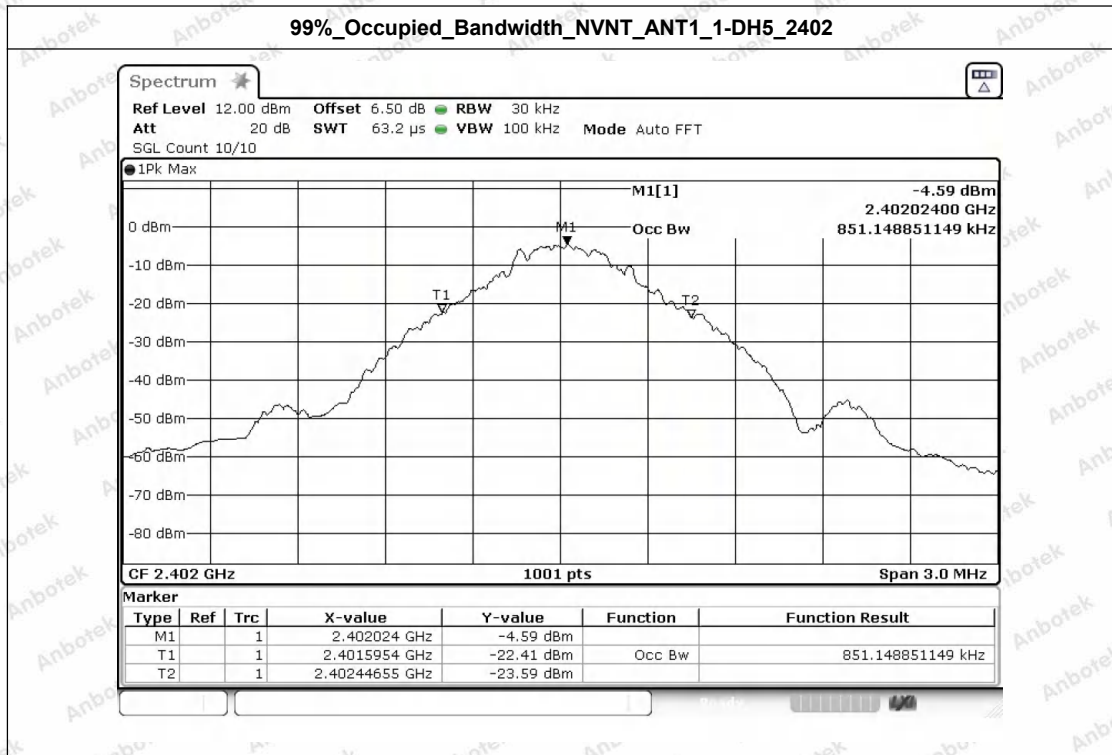

99%_Occupied_Bandwidth_NVNT_ANT1_1-DH5_2441



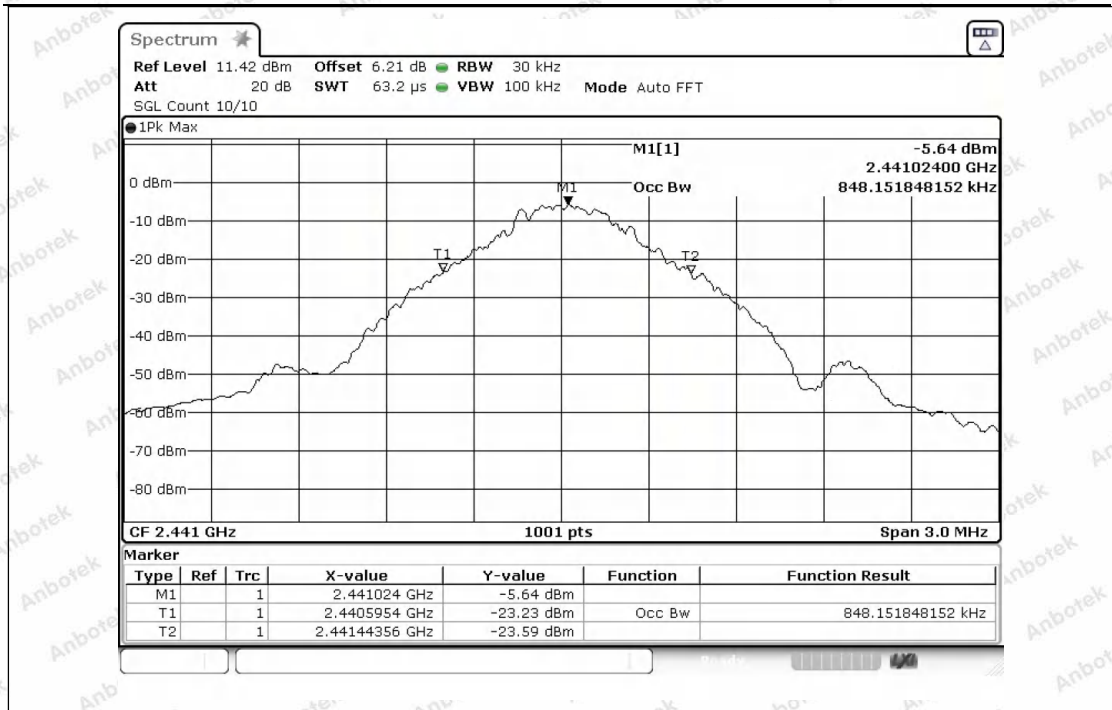

99%_Occupied_Bandwidth_NVNT_ANT1_1-DH5_2480

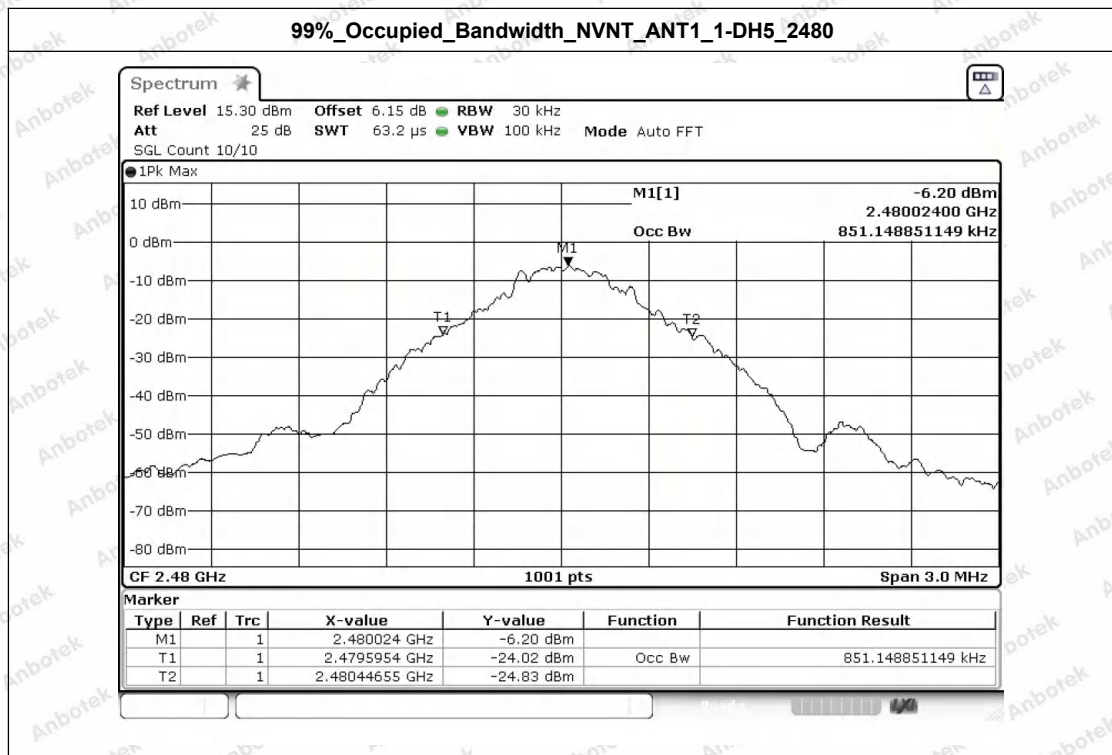

99%_Occupied_Bandwidth_NVNT_ANT1_2-DH5_2402

Shenzhen Anbotek Compliance Laboratory Limited

Address: 1/F., Building D, Sogood Science and Technology Park, Sanwei Community, Hangcheng Street, Bao'an District, Shenzhen, Guangdong, China.
 Tel: (86) 0755-26066440 Fax: (86) 0755-26014772 Email: service@anbotek.com

Hotline 400-003-0500
 www.anbotek.com.cn



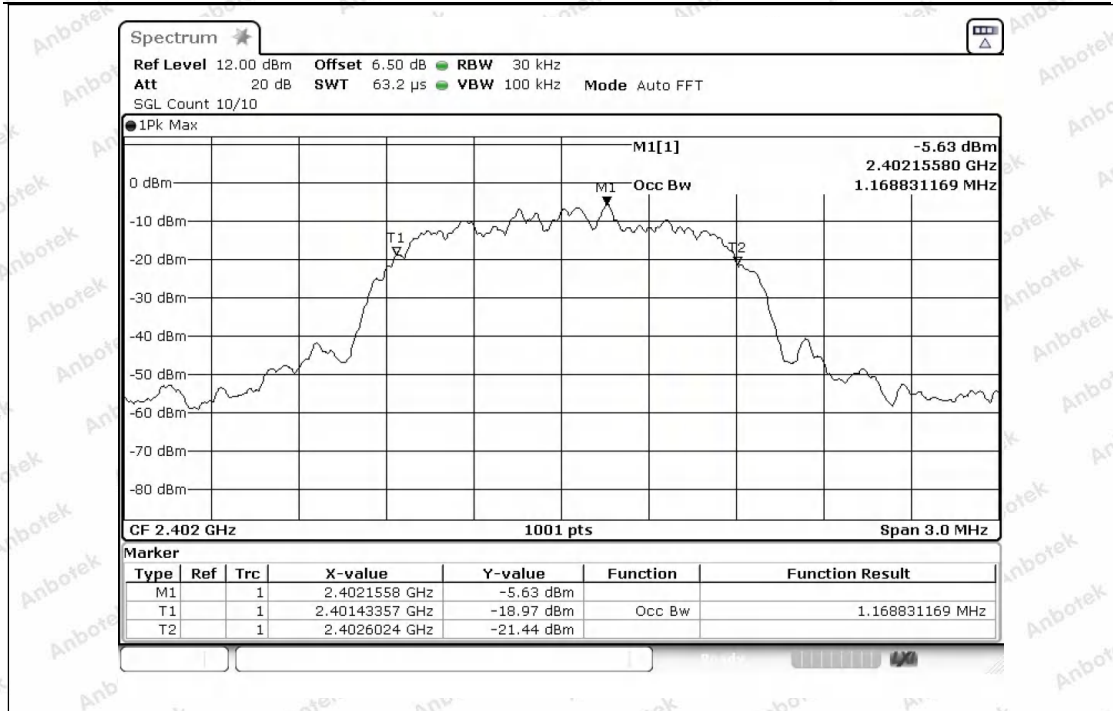

99%_Occupied_Bandwidth_NVNT_ANT1_2-DH5_2441

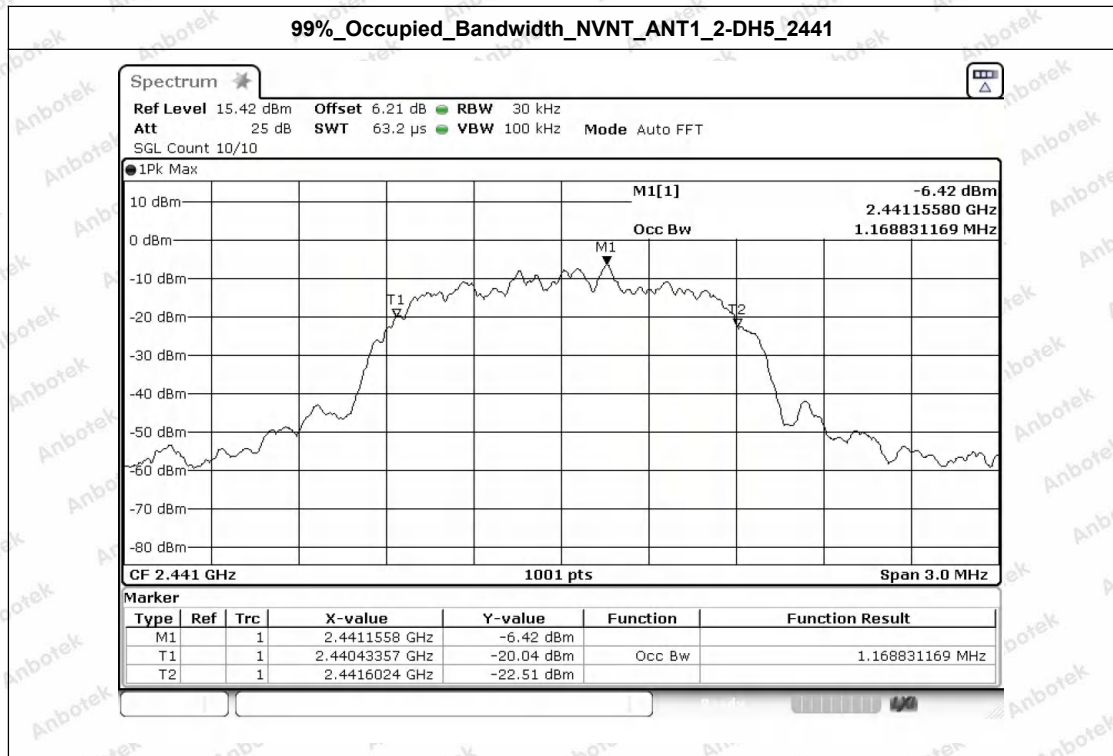

99%_Occupied_Bandwidth_NVNT_ANT1_2-DH5_2480

Shenzhen Anbotek Compliance Laboratory Limited

Address: 1/F., Building D, Sogood Science and Technology Park, Sanwei Community, Hangcheng Street, Bao'an District, Shenzhen, Guangdong, China.
 Tel: (86) 0755-26066440 Fax: (86) 0755-26014772 Email: service@anbotek.com

Hotline
 400-003-0500
 www.anbotek.com.cn



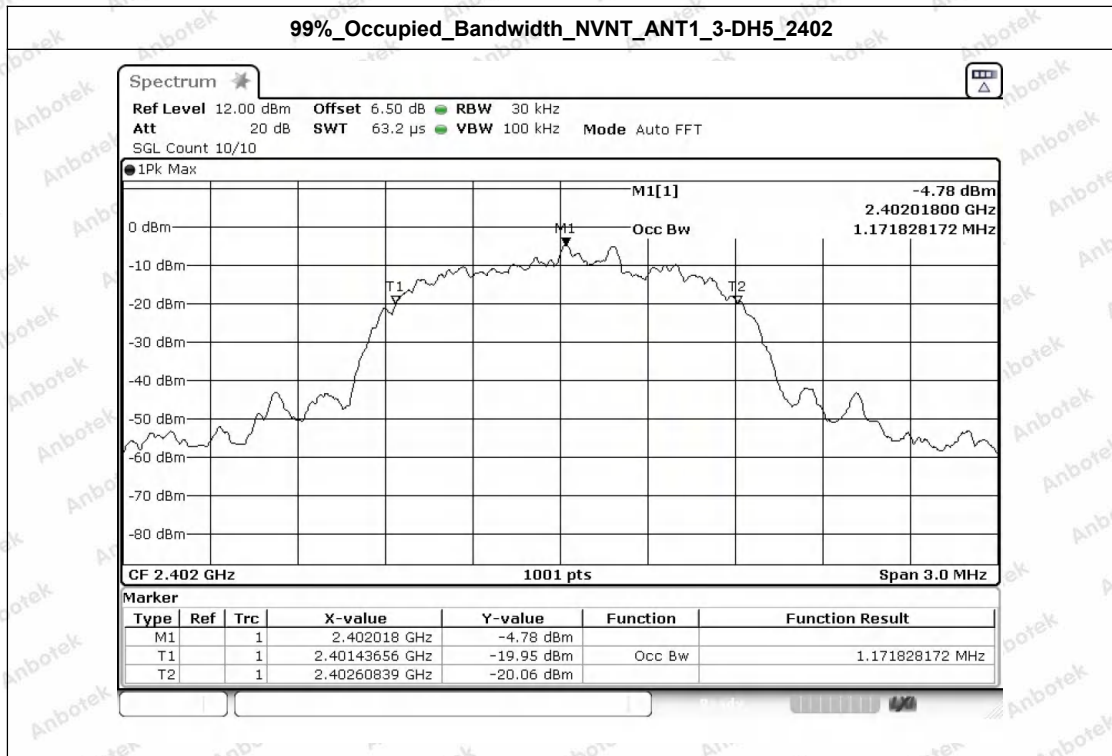
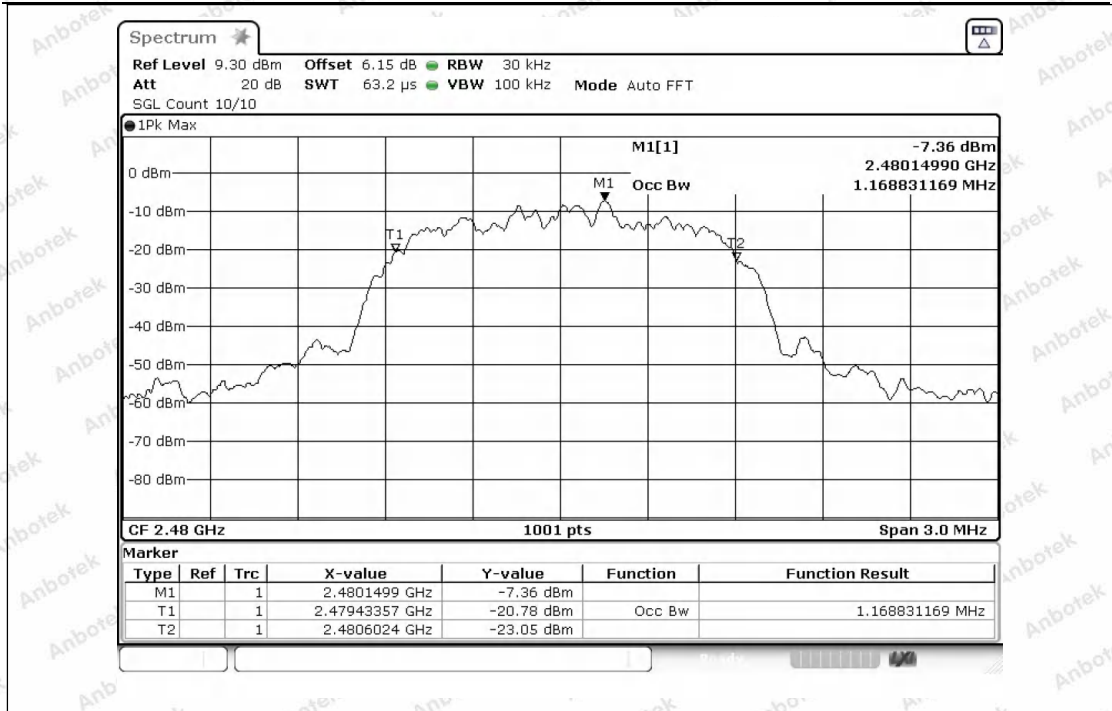

99%_Occupied_Bandwidth_NVNT_ANT1_3-DH5_2441



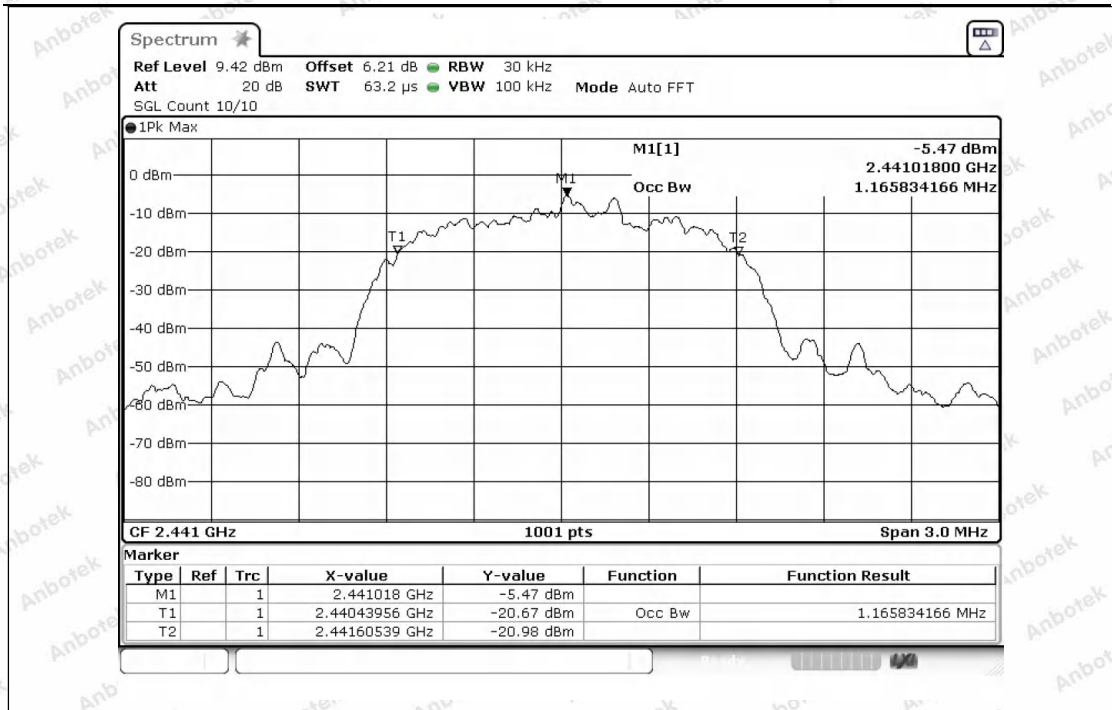

99%_Occupied_Bandwidth_NVNT_ANT1_3-DH5_2480

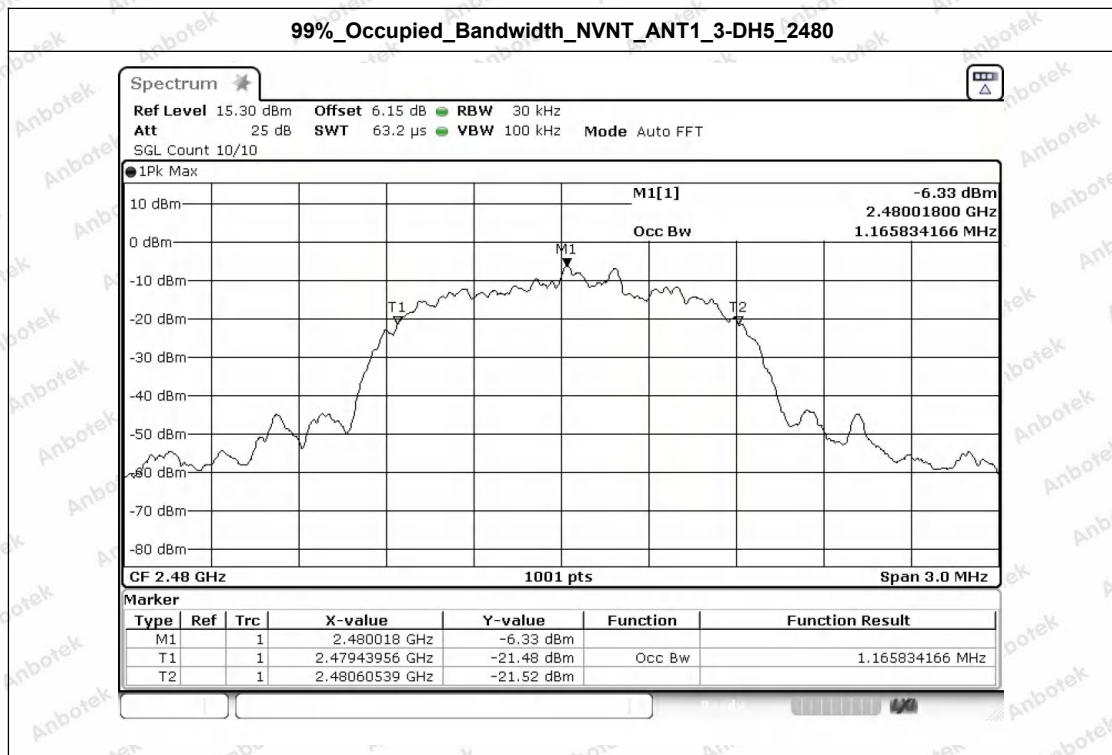

Shenzhen Anbotek Compliance Laboratory Limited

Address: 1/F., Building D, Sogood Science and Technology Park, Sanwei Community, Hangcheng Street, Bao'an District, Shenzhen, Guangdong, China.
 Tel: (86) 0755-26066440 Fax: (86) 0755-26014772 Email: service@anbotek.com

Hotline 400-003-0500
 www.anbotek.com.cn



Appendix C: Peak Output Power

Condition	Antenna	Modulation	Frequency (MHz)	Max. Conducted Power(dBm)	Max. Conducted Power(mW)	Limit(mW)	Result
NVNT	ANT1	1-DH5	2402.00	-2.66	0.54	1000	Pass
NVNT	ANT1	1-DH5	2441.00	-3.59	0.44	1000	Pass
NVNT	ANT1	1-DH5	2480.00	-4.20	0.38	1000	Pass
NVNT	ANT1	2-DH5	2402.00	-0.33	0.93	125	Pass
NVNT	ANT1	2-DH5	2441.00	-1.42	0.72	125	Pass
NVNT	ANT1	2-DH5	2480.00	-2.18	0.60	125	Pass
NVNT	ANT1	3-DH5	2402.00	0.51	1.13	125	Pass
NVNT	ANT1	3-DH5	2441.00	-0.92	0.81	125	Pass
NVNT	ANT1	3-DH5	2480.00	-1.61	0.69	125	Pass

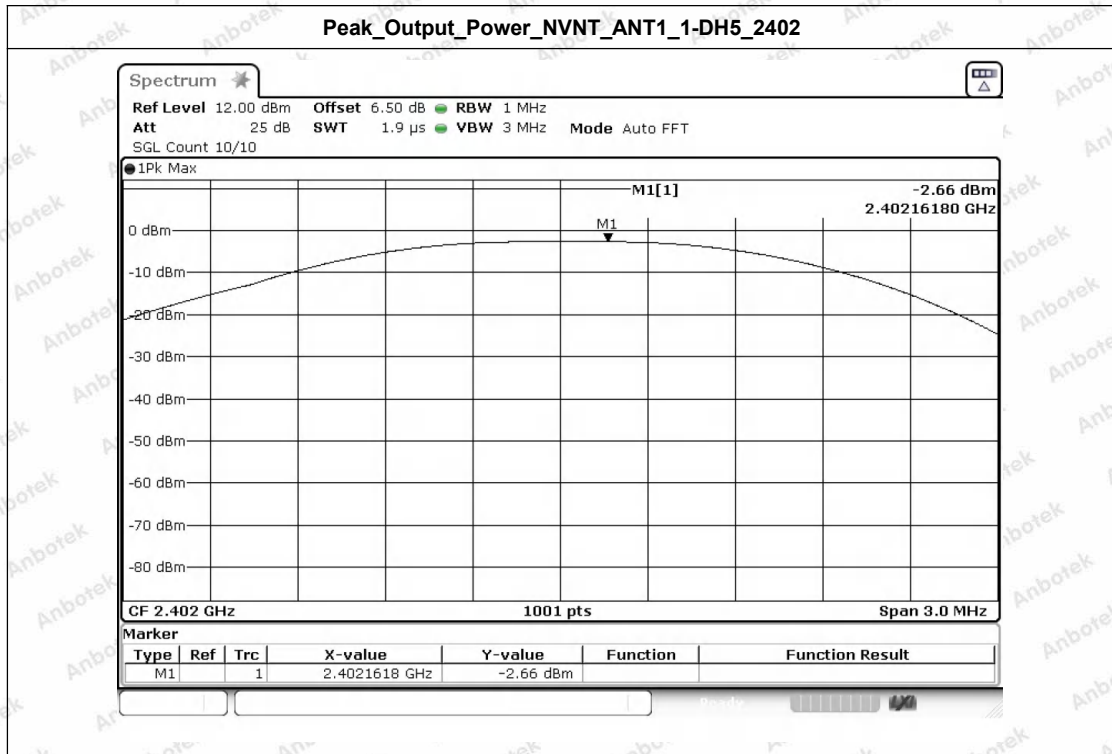

Peak_Output_Power_NVNT_ANT1_1-DH5_2441



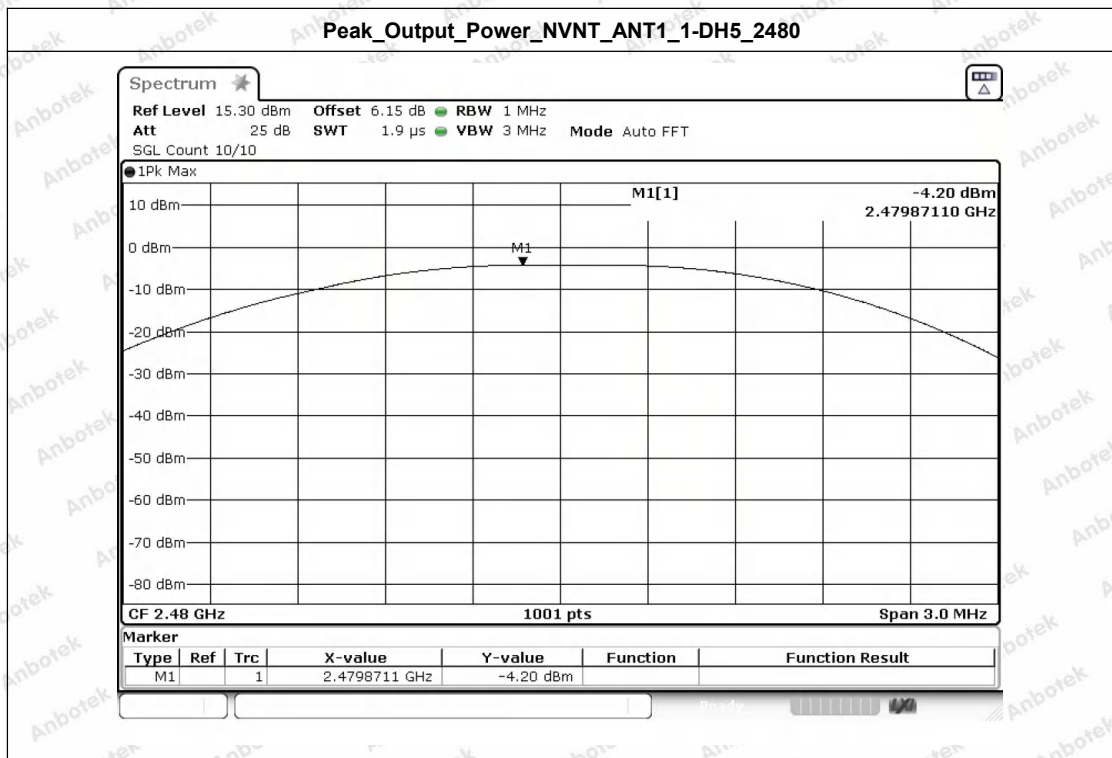
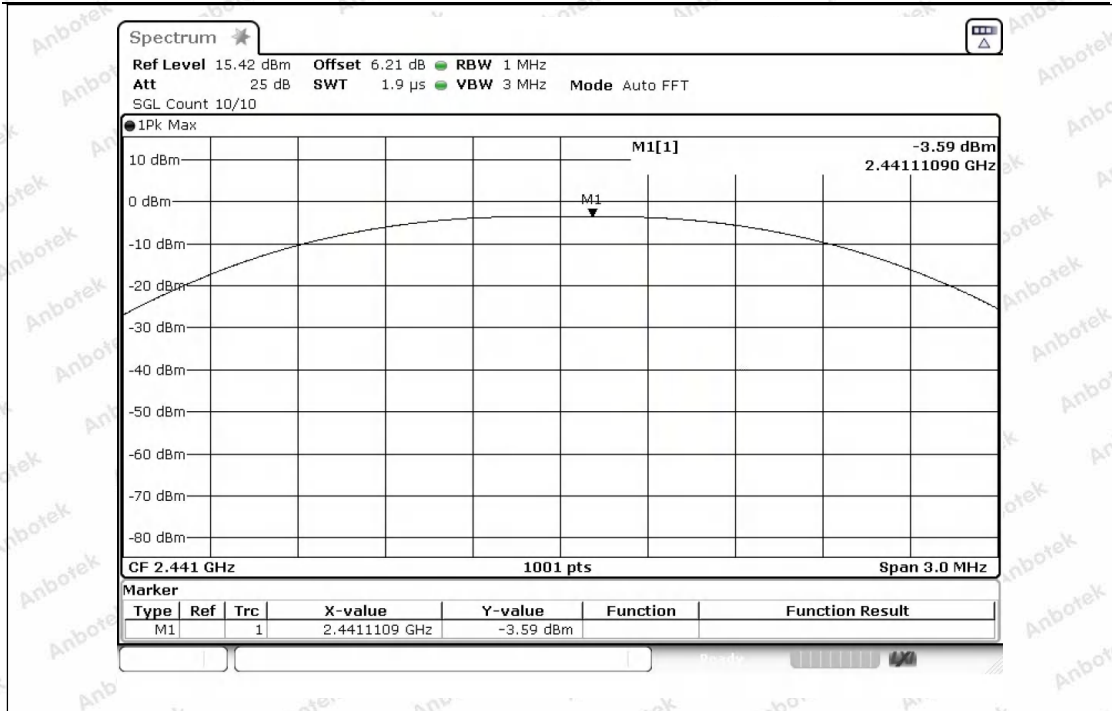

Peak_Output_Power_NVNT_ANT1_2-DH5_2402



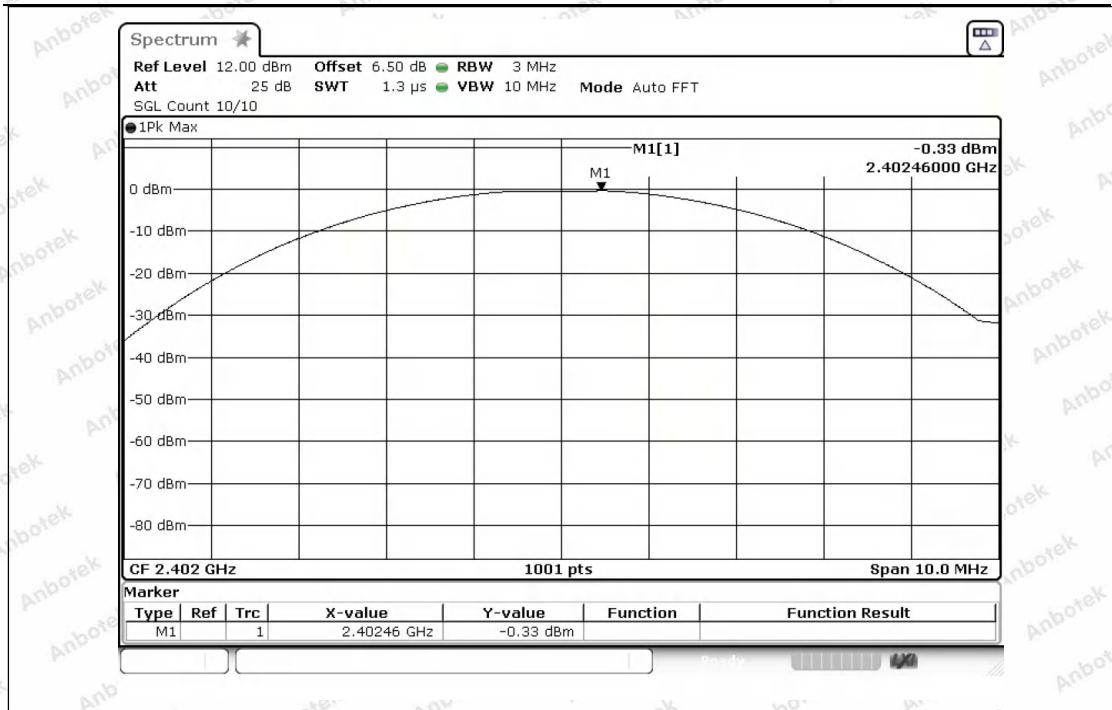

Peak_Output_Power_NVNT_ANT1_2-DH5_2441

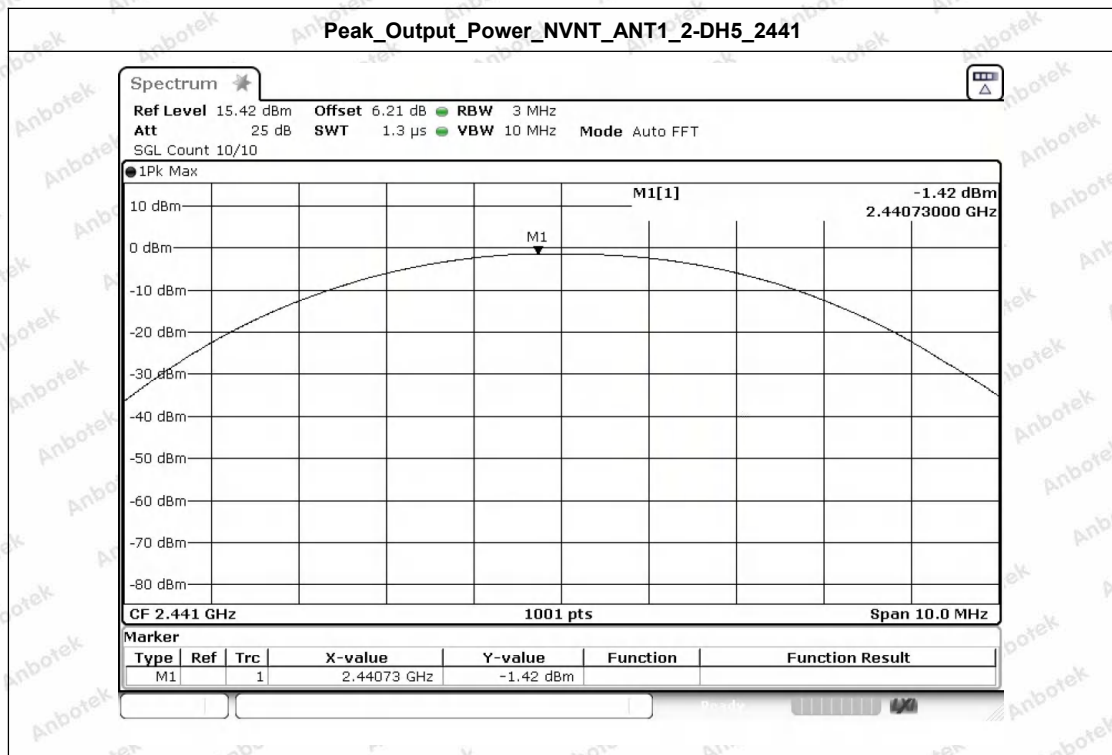

Peak_Output_Power_NVNT_ANT1_2-DH5_2480



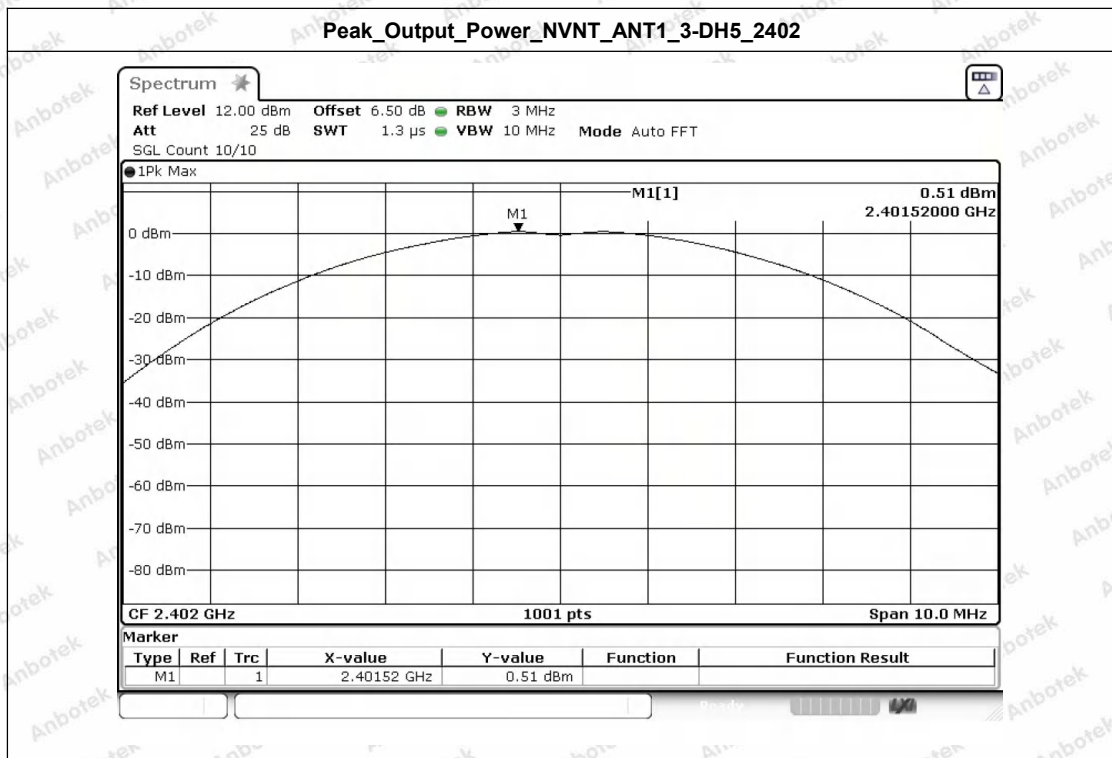
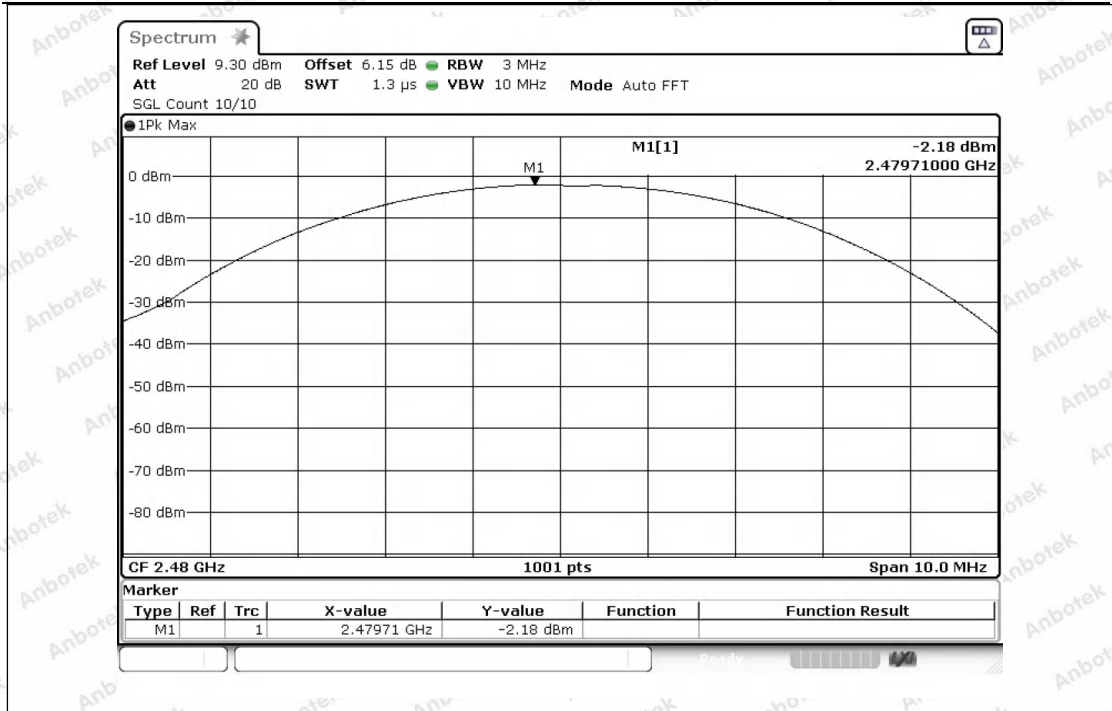

Peak Output Power NVNT_ANT1_3-DH5_2441



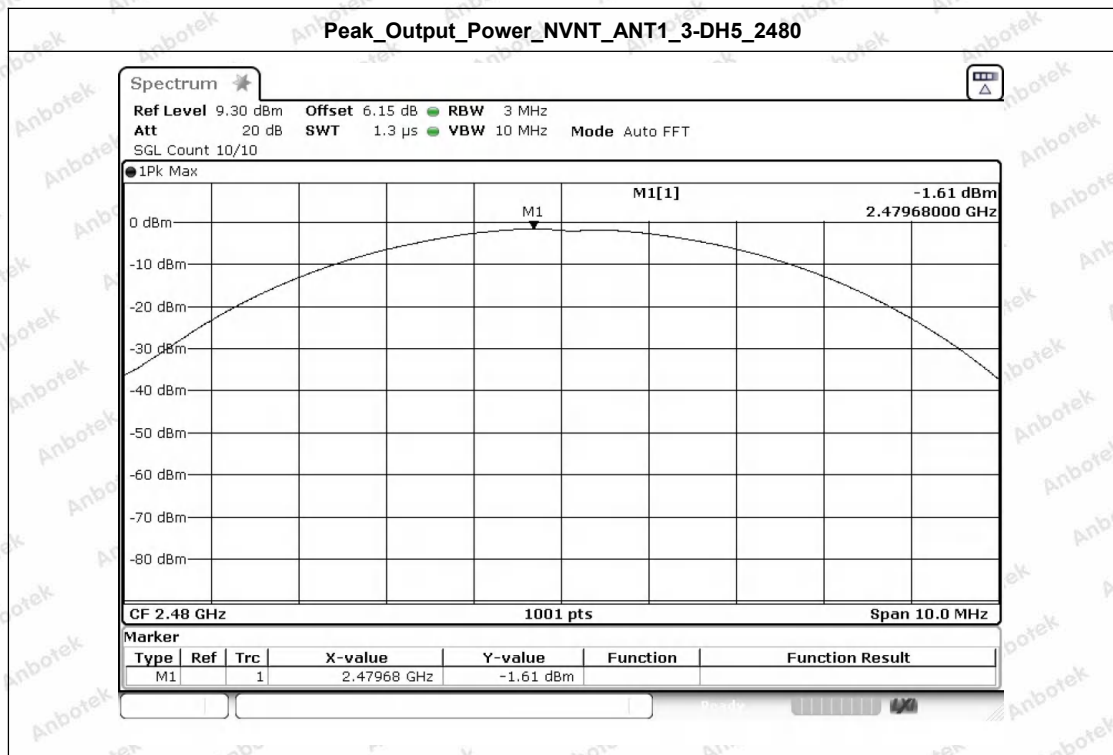
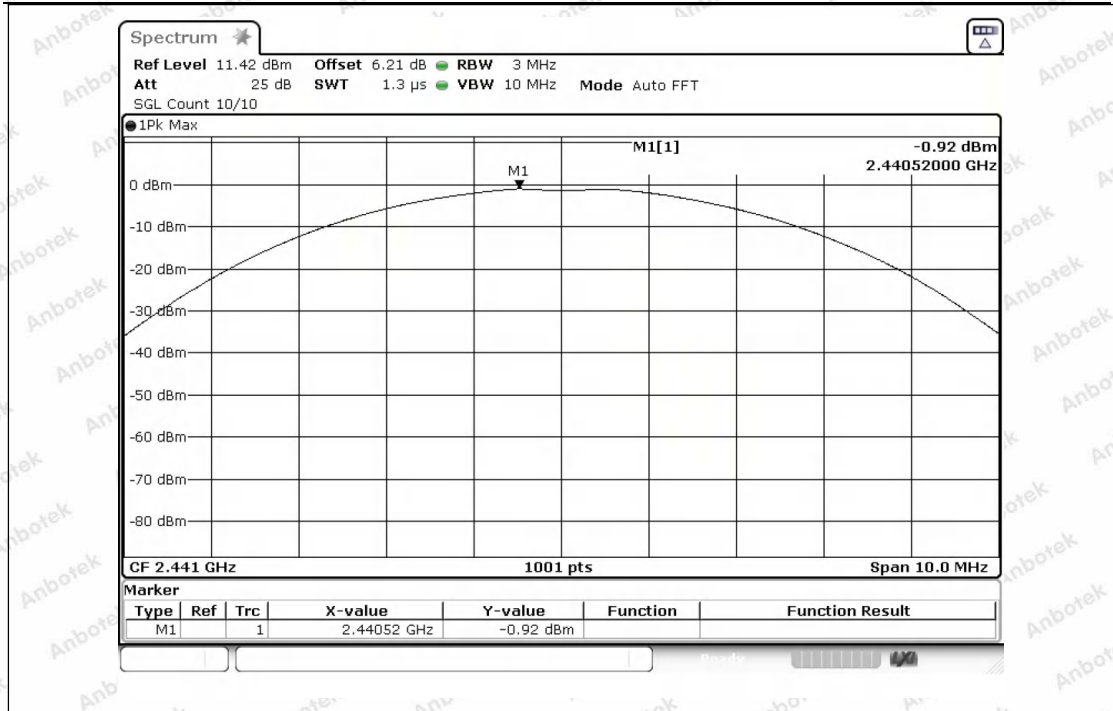

Shenzhen Anbotek Compliance Laboratory Limited

Address: 1/F., Building D, Sogood Science and Technology Park, Sanwei Community, Hangcheng Street, Bao'an District, Shenzhen, Guangdong, China.
 Tel: (86) 0755-26066440 Fax: (86) 0755-26014772 Email: service@anbotek.com

Hotline
 400-003-0500
 www.anbotek.com.cn



Appendix D: Spurious Emissions

Condition	Antenna	Modulation	TX Mode	Spurious MAX.Value(dBm)	Limit	Result
NVNT	ANT1	1-DH5	2402.00	-51.271	-22.815	Pass
NVNT	ANT1	1-DH5	2441.00	-31.735	-23.738	Pass
NVNT	ANT1	1-DH5	2480.00	-44.711	-24.458	Pass
NVNT	ANT1	2-DH5	2402.00	-50.170	-22.838	Pass
NVNT	ANT1	2-DH5	2441.00	-46.863	-23.968	Pass
NVNT	ANT1	2-DH5	2480.00	-50.163	-24.581	Pass
NVNT	ANT1	3-DH5	2402.00	-43.254	-22.299	Pass
NVNT	ANT1	3-DH5	2441.00	-48.426	-23.350	Pass
NVNT	ANT1	3-DH5	2480.00	-41.872	-24.269	Pass

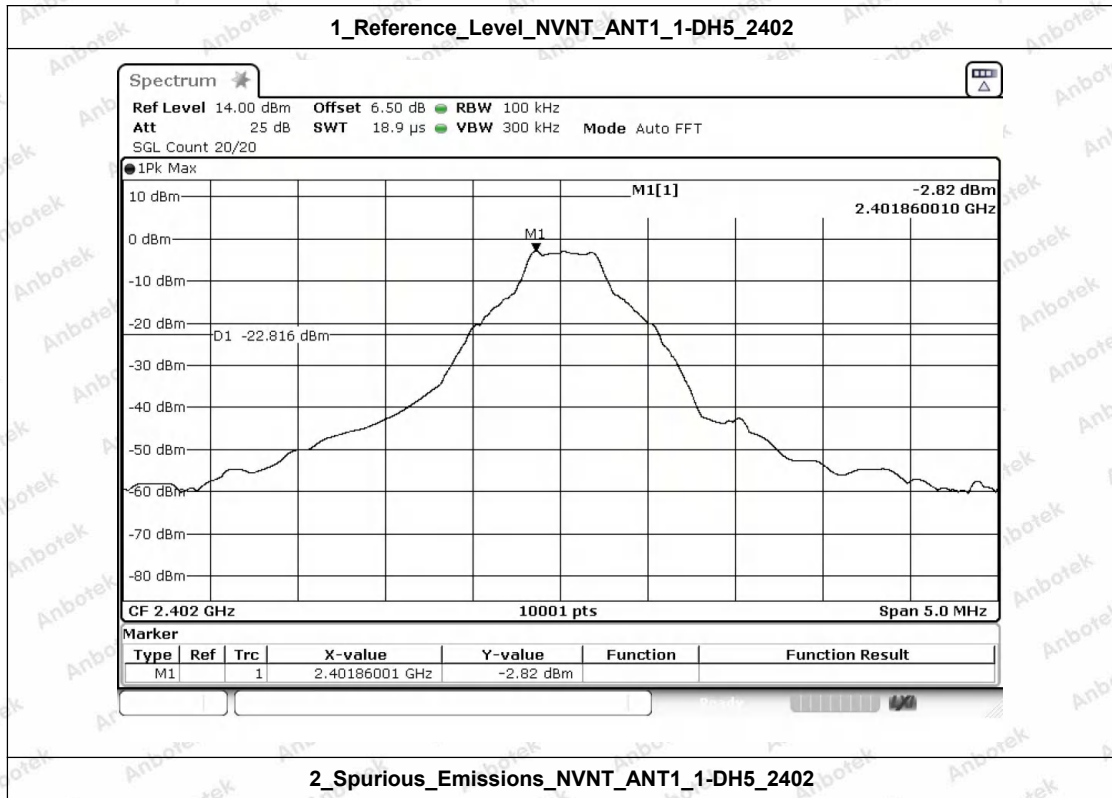

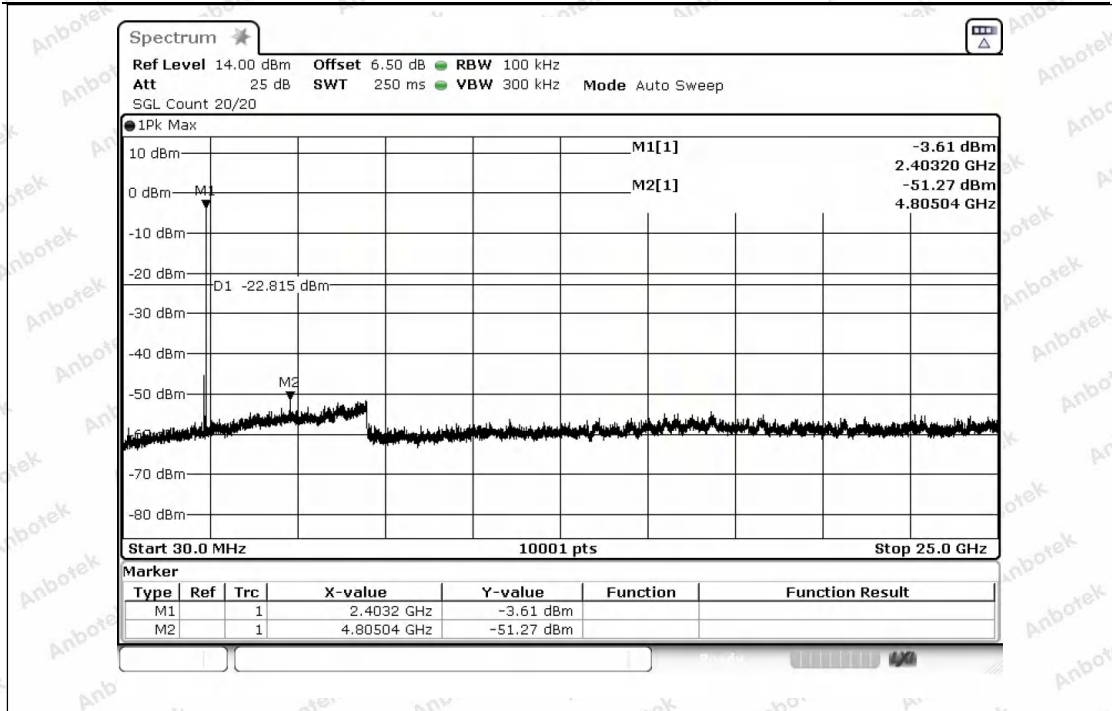

1_Reference_Level_NVNT_ANT1_1-DH5_2441

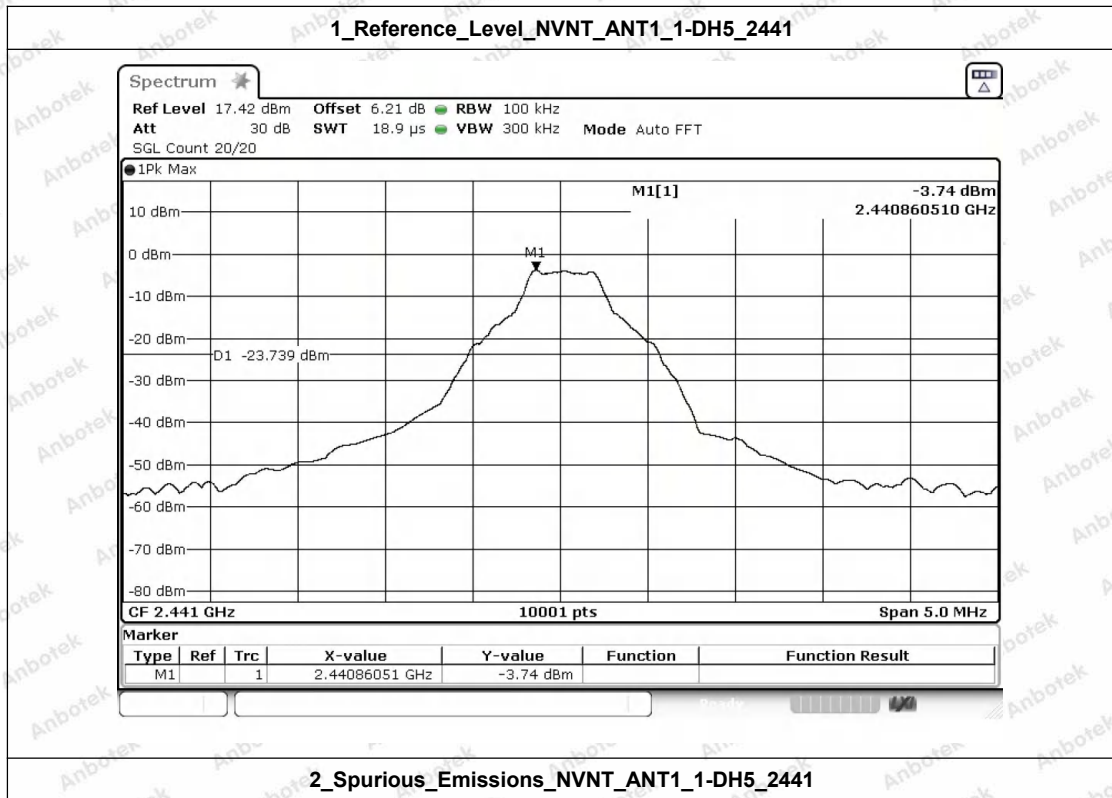

2_Spurious_Emissions_NVNT_ANT1_1-DH5_2441

Shenzhen Anbotek Compliance Laboratory Limited

Address: 1/F., Building D, Sogood Science and Technology Park, Sanwei Community, Hangcheng Street, Bao'an District, Shenzhen, Guangdong, China.
 Tel: (86) 0755-26066440 Fax: (86) 0755-26014772 Email: service@anbotek.com

Hotline 400-003-0500
 www.anbotek.com.cn



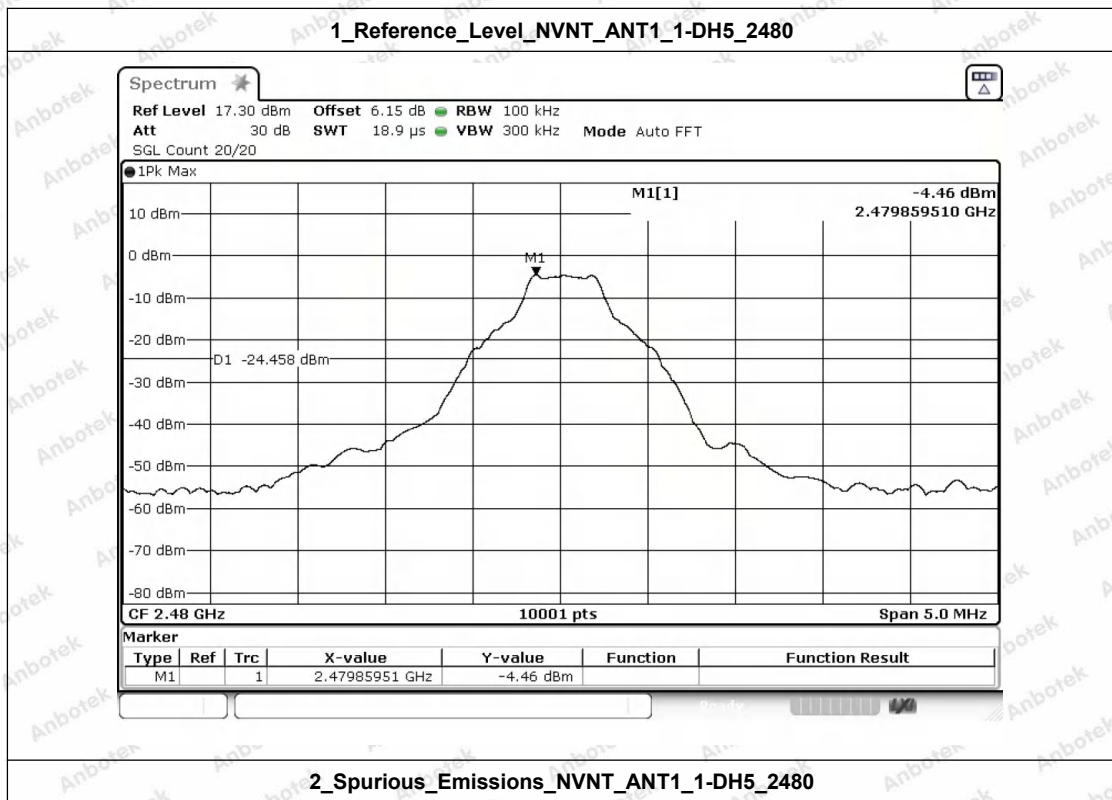
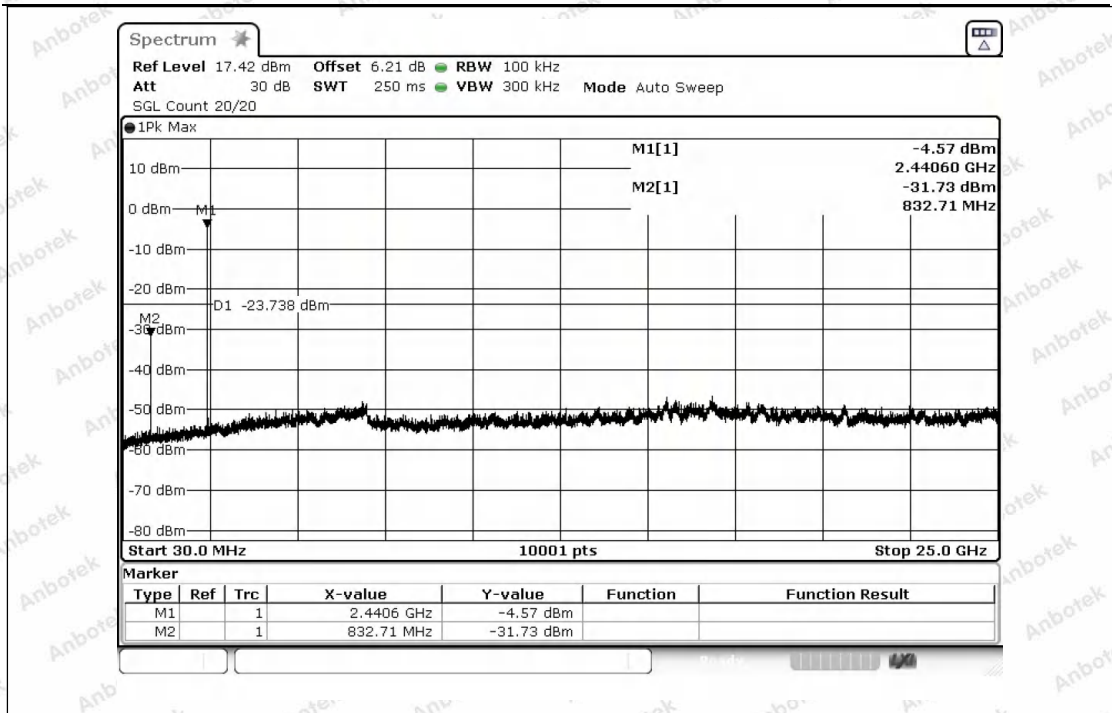

2_Spurious_Emissions_NVNT_ANT1_1-DH5_2480

Shenzhen Anbotek Compliance Laboratory Limited

Address: 1/F., Building D, Sogood Science and Technology Park, Sanwei Community, Hangcheng Street, Bao'an District, Shenzhen, Guangdong, China.
 Tel: (86) 0755-26066440 Fax: (86) 0755-26014772 Email: service@anbotek.com

Hotline
 400-003-0500
 www.anbotek.com.cn



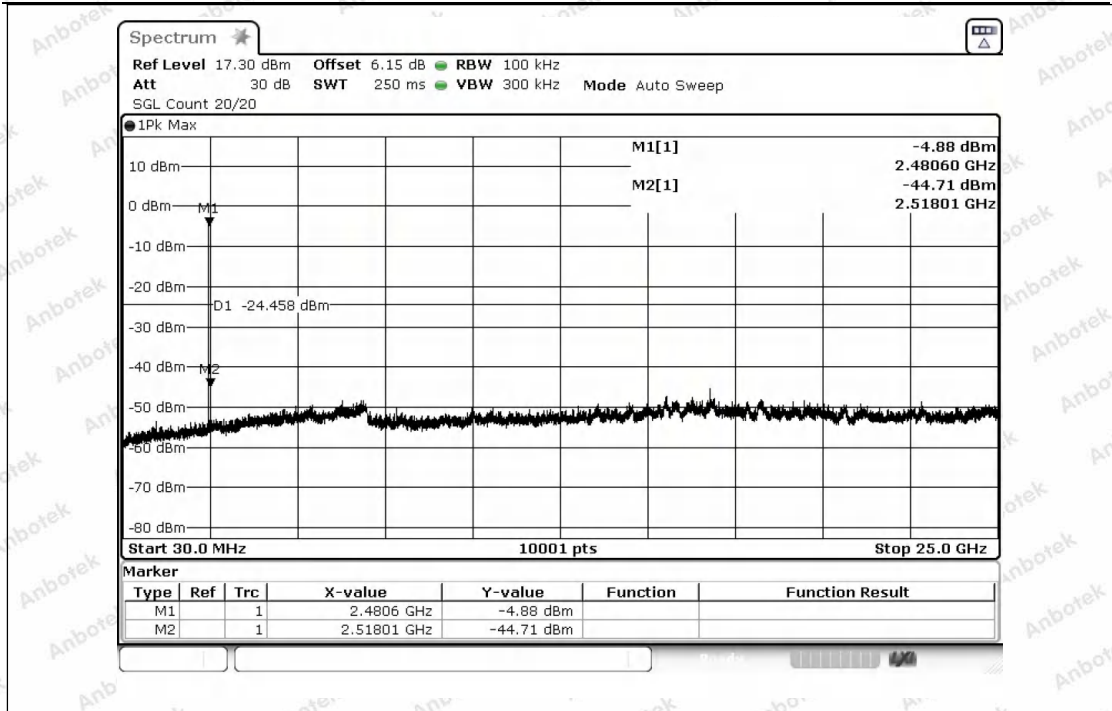

1_Reference_Level_NVNT_ANT1_2-DH5_2402

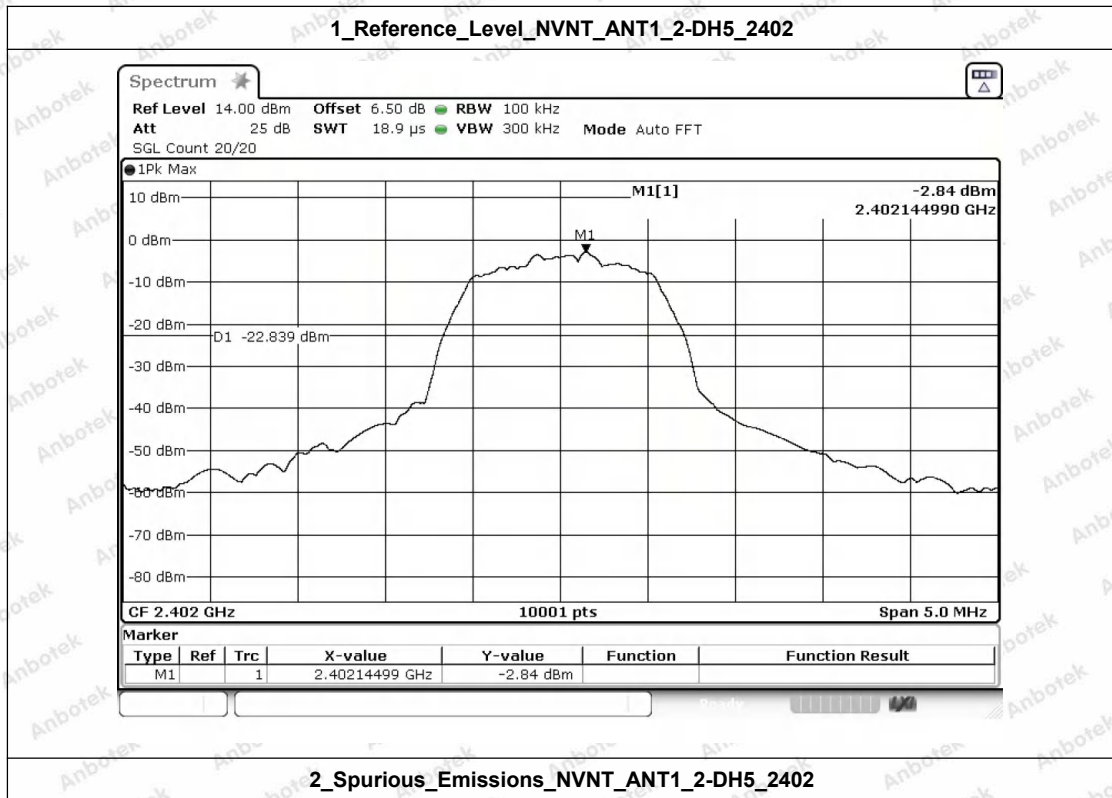

2_Spurious_Emissions_NVNT_ANT1_2-DH5_2402

Shenzhen Anbotek Compliance Laboratory Limited

Address: 1/F., Building D, Sogood Science and Technology Park, Sanwei Community, Hangcheng Street, Bao'an District, Shenzhen, Guangdong, China.
 Tel: (86) 0755-26066440 Fax: (86) 0755-26014772 Email: service@anbotek.com

Hotline 400-003-0500
 www.anbotek.com.cn



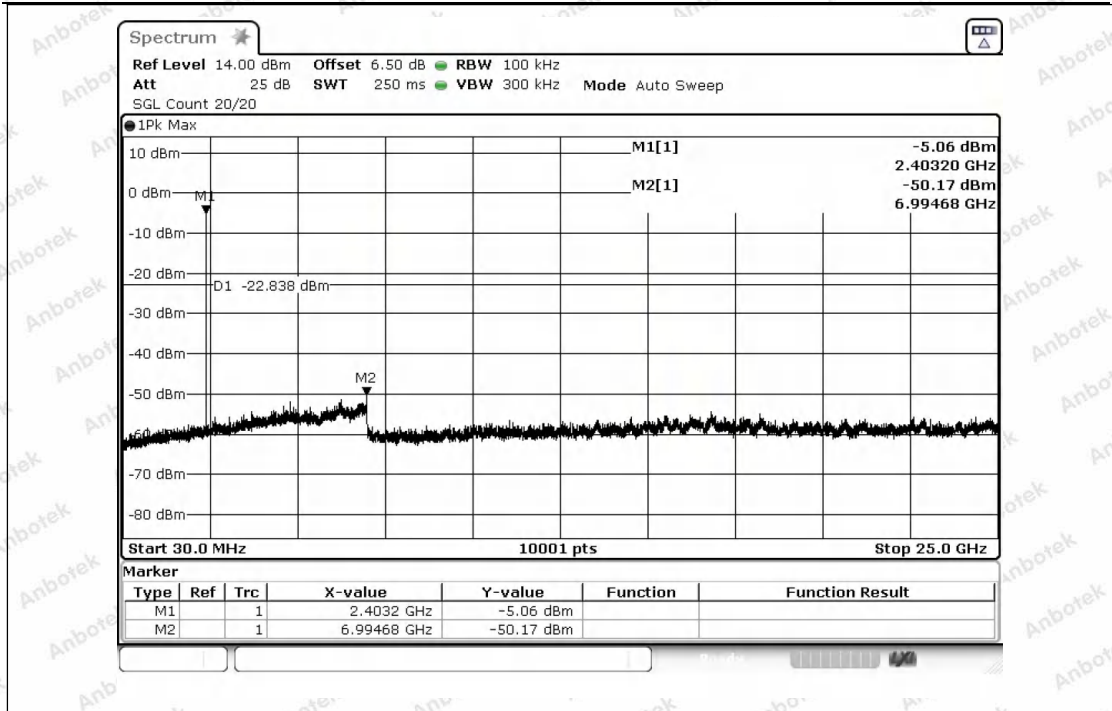

1_Reference_Level_NVNT_ANT1_2-DH5_2441

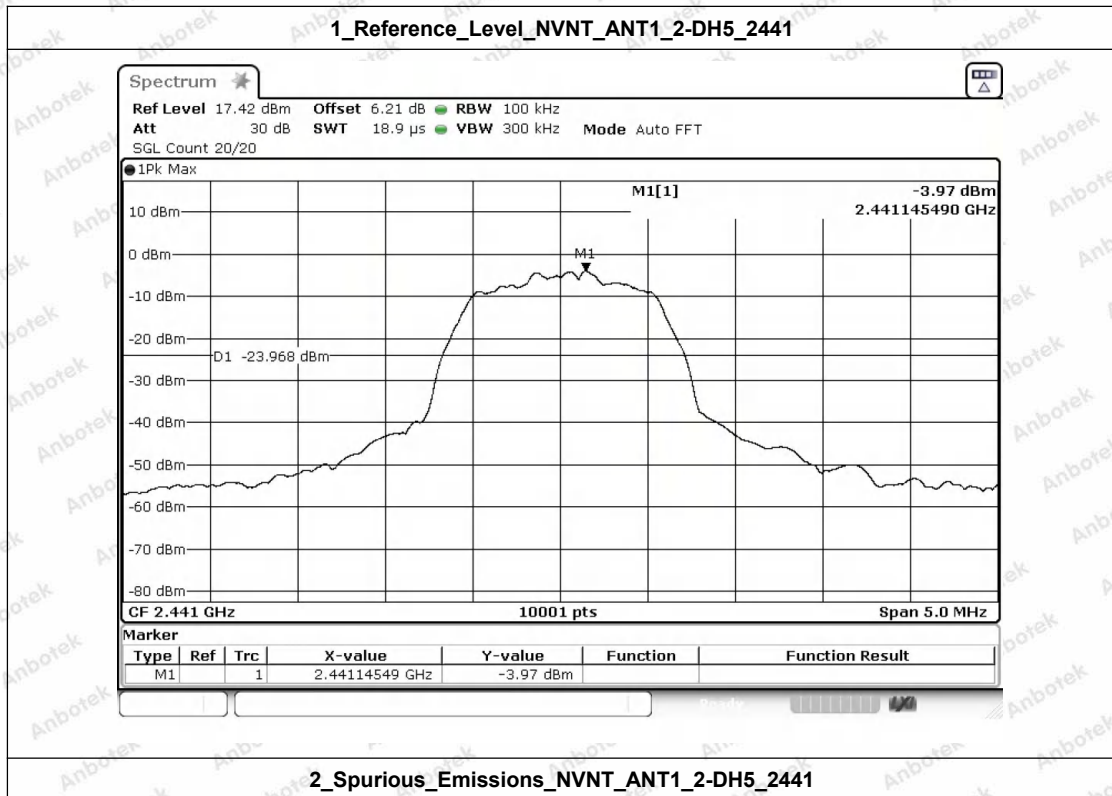

2_Spurious_Emissions_NVNT_ANT1_2-DH5_2441

Shenzhen Anbotek Compliance Laboratory Limited

Address: 1/F., Building D, Sogood Science and Technology Park, Sanwei Community, Hangcheng Street, Bao'an District, Shenzhen, Guangdong, China.
 Tel: (86) 0755-26066440 Fax: (86) 0755-26014772 Email: service@anbotek.com

Hotline 400-003-0500
 www.anbotek.com.cn



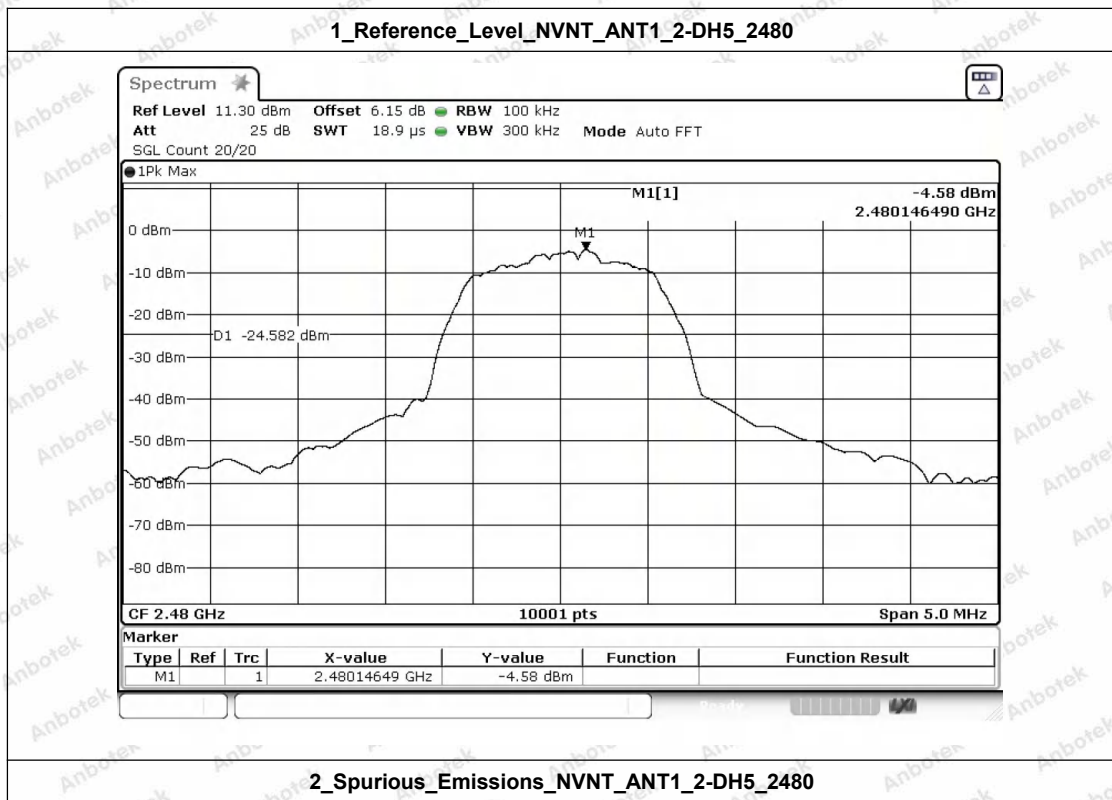
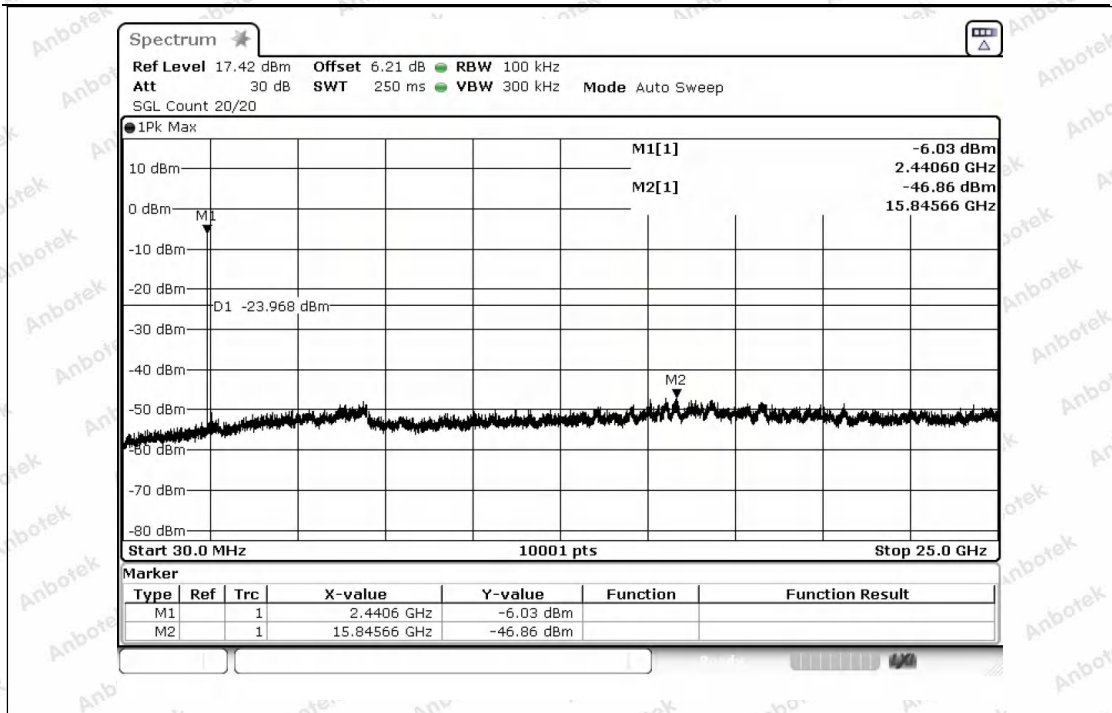

2_Spurious_Emissions_NVNT_ANT1_2-DH5_2480

Shenzhen Anbotek Compliance Laboratory Limited

Address: 1/F., Building D, Sogood Science and Technology Park, Sanwei Community, Hangcheng Street, Bao'an District, Shenzhen, Guangdong, China.
 Tel: (86) 0755-26066440 Fax: (86) 0755-26014772 Email: service@anbotek.com

Hotline
 400-003-0500
 www.anbotek.com.cn



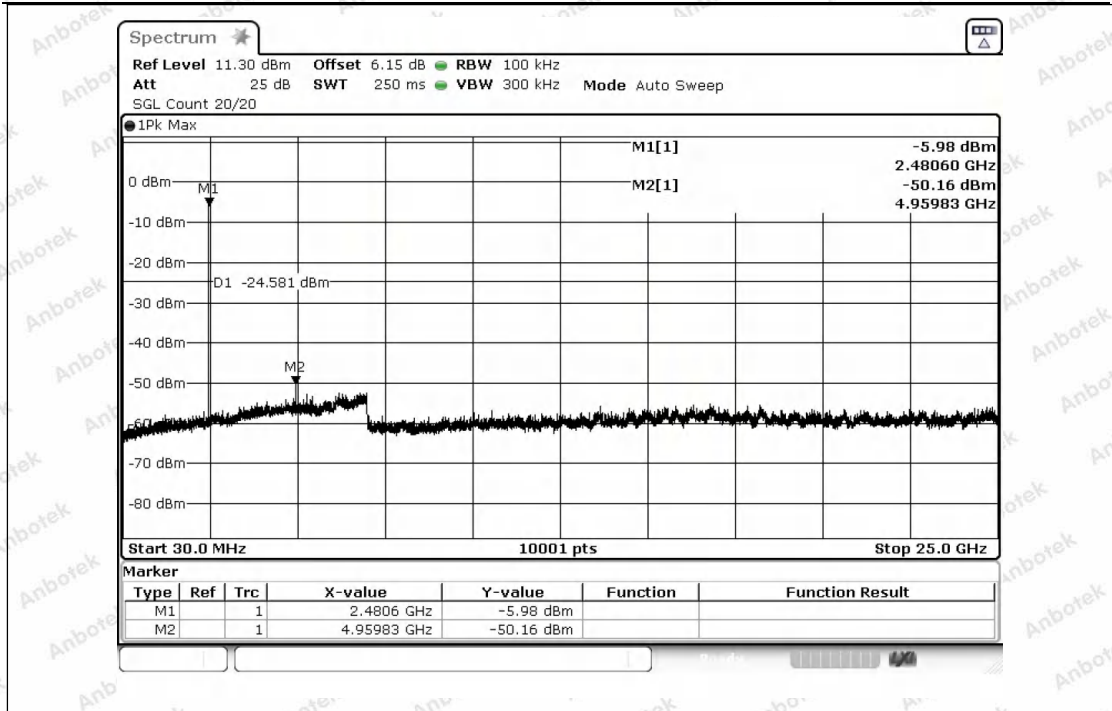

1_Reference_Level_NVNT_ANT1_3-DH5_2402

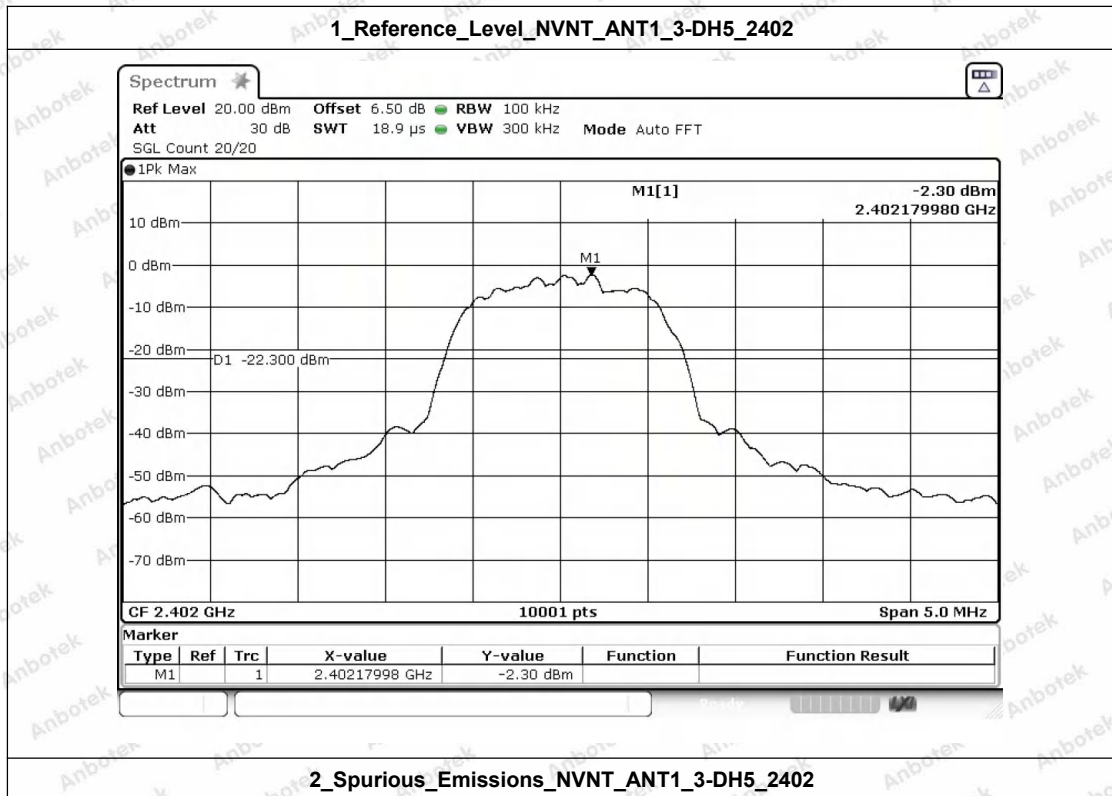

2_Spurious_Emissions_NVNT_ANT1_3-DH5_2402

Shenzhen Anbotek Compliance Laboratory Limited

Address: 1/F., Building D, Sogood Science and Technology Park, Sanwei Community, Hangcheng Street, Bao'an District, Shenzhen, Guangdong, China.
 Tel: (86) 0755-26066440 Fax: (86) 0755-26014772 Email: service@anbotek.com

Hotline
 400-003-0500
 www.anbotek.com.cn



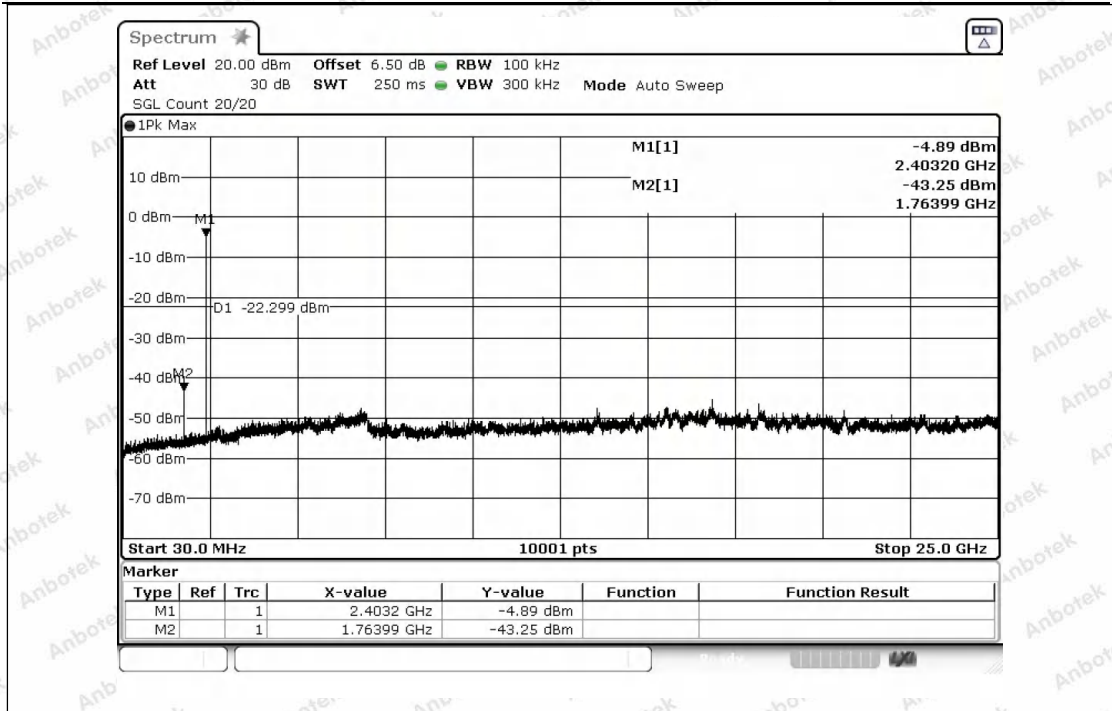

1_Reference_Level_NVNT_ANT1_3-DH5_2441

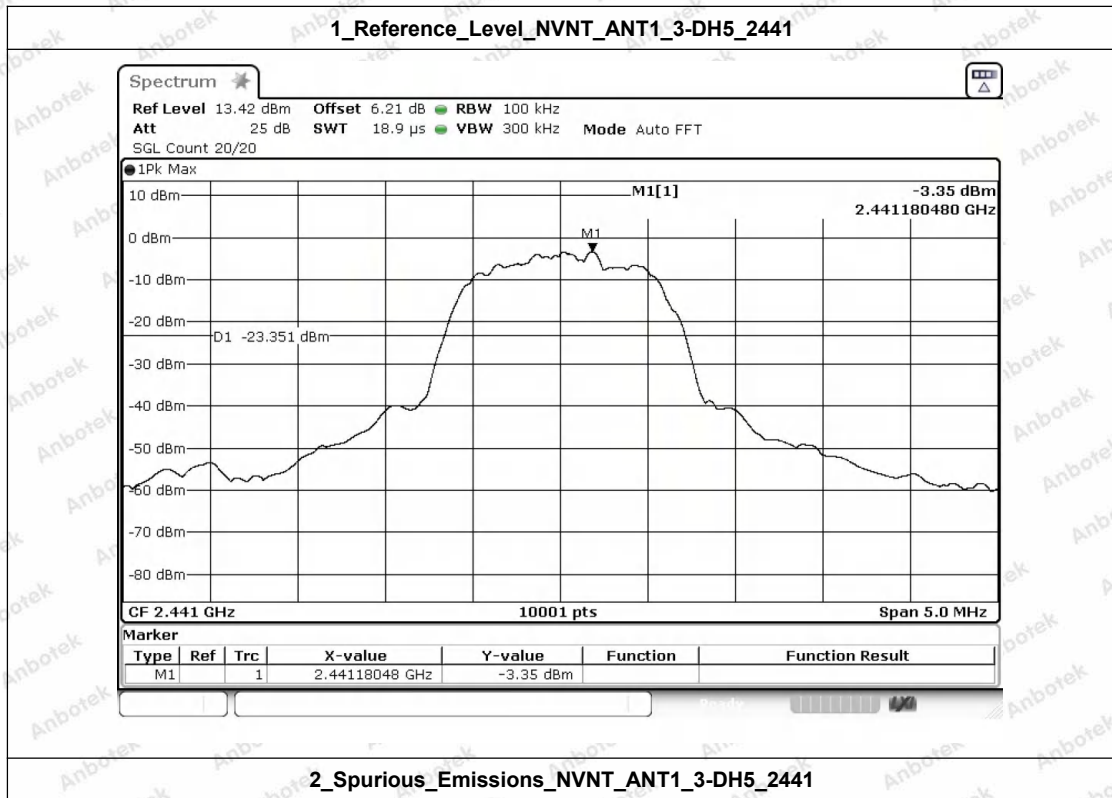

2_Spurious_Emissions_NVNT_ANT1_3-DH5_2441

Shenzhen Anbotek Compliance Laboratory Limited

Address: 1/F., Building D, Sogood Science and Technology Park, Sanwei Community, Hangcheng Street, Bao'an District, Shenzhen, Guangdong, China.
 Tel: (86) 0755-26066440 Fax: (86) 0755-26014772 Email: service@anbotek.com

Hotline 400-003-0500
 www.anbotek.com.cn



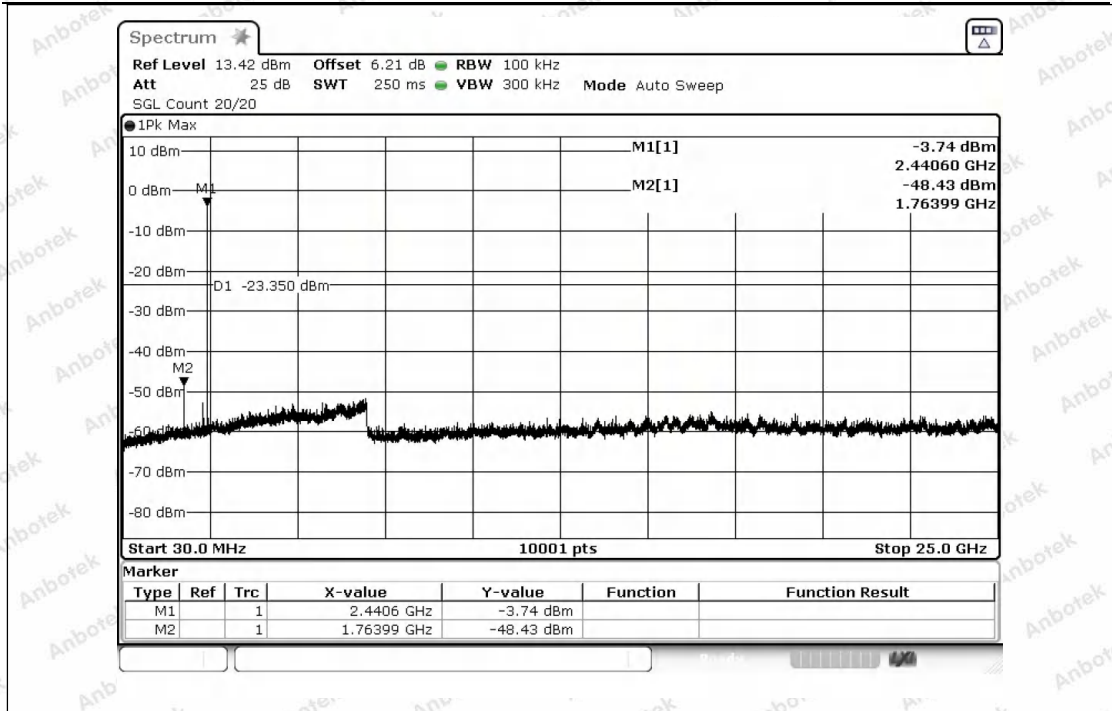

1_Reference_Level_NVNT_ANT1_3-DH5_2480

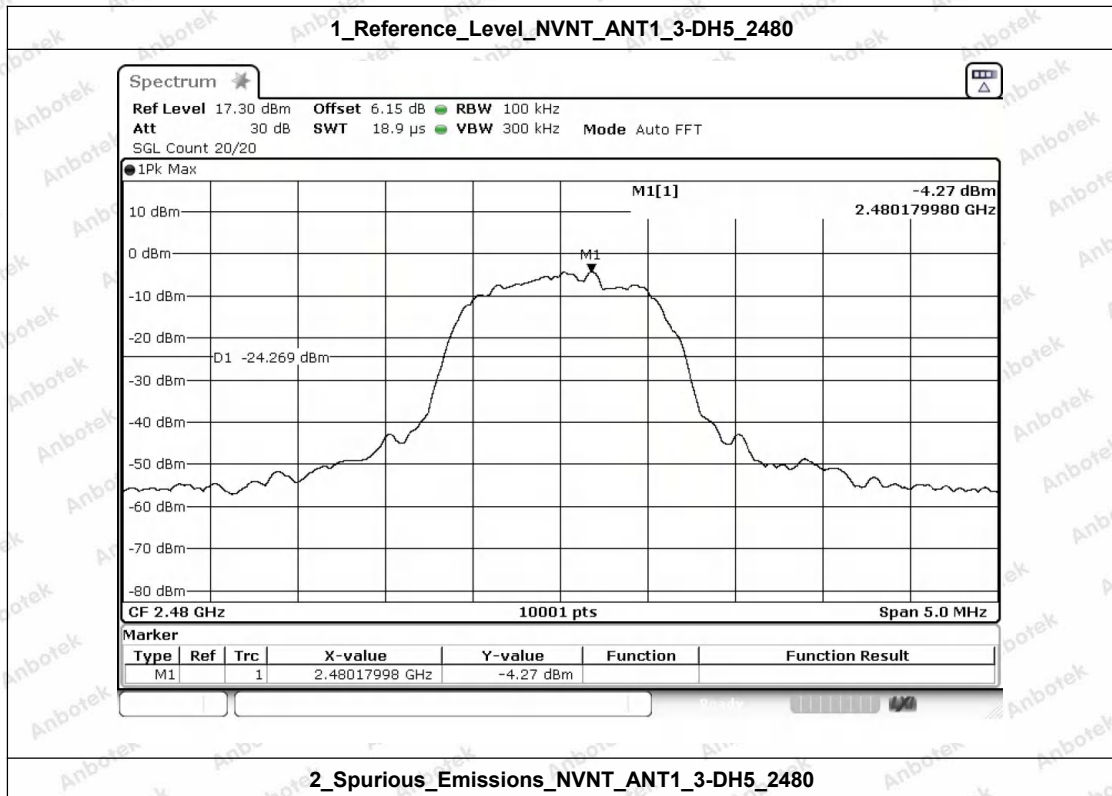

2_Spurious_Emissions_NVNT_ANT1_3-DH5_2480

Shenzhen Anbotek Compliance Laboratory Limited

Address: 1/F., Building D, Sogood Science and Technology Park, Sanwei Community, Hangcheng Street, Bao'an District, Shenzhen, Guangdong, China.
 Tel: (86) 0755-26066440 Fax: (86) 0755-26014772 Email: service@anbotek.com

Hotline 400-003-0500
 www.anbotek.com.cn



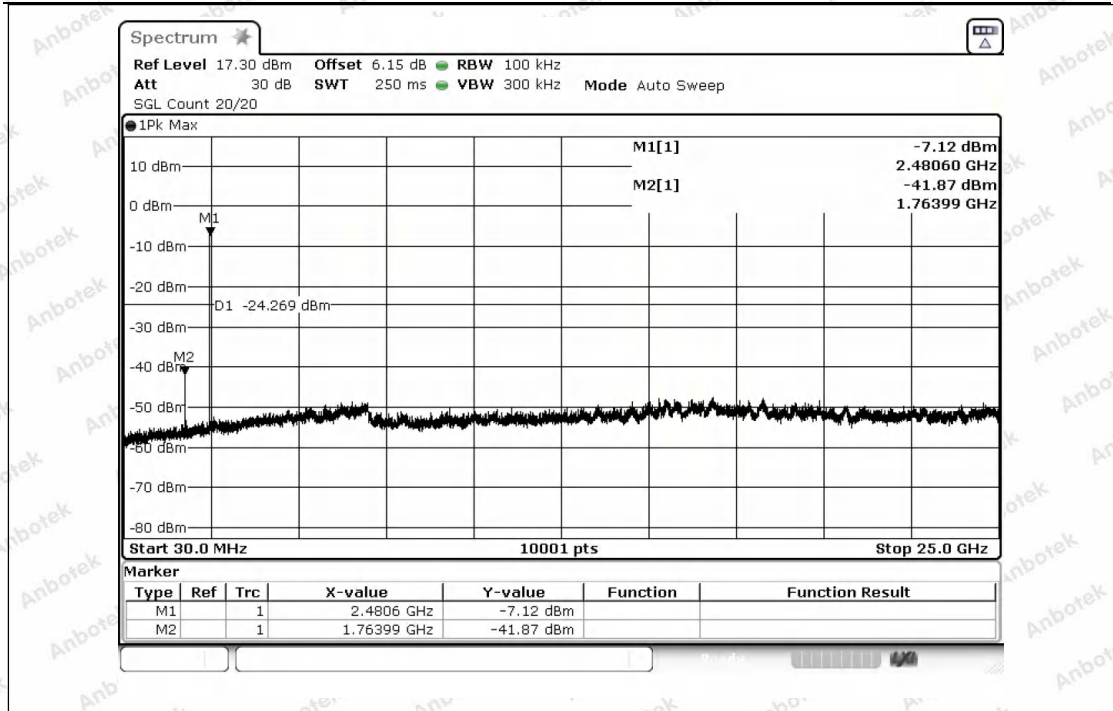

Shenzhen Anbotek Compliance Laboratory Limited

Address: 1/F., Building D, Sogood Science and Technology Park, Sanwei Community, Hangcheng Street, Bao'an District, Shenzhen, Guangdong, China.
 Tel: (86) 0755-26066440 Fax: (86) 0755-26014772 Email: service@anbotek.com

 Hotline
 400-003-0500
www.anbotek.com.cn



Appendix E: Bandedge

Condition	Antenna	Modulation	TX Mode	Bandedge MAX.Value	Limit	Result
NVNT	ANT1	1-DH5	2402.00	-55.814	-22.815	Pass
NVNT	ANT1	1-DH5	Hopping_LCH	-56.367	-22.738	Pass
NVNT	ANT1	1-DH5	2480.00	-52.942	-24.458	Pass
NVNT	ANT1	1-DH5	Hopping_HCH	-56.554	-22.752	Pass
NVNT	ANT1	2-DH5	2402.00	-55.128	-22.838	Pass
NVNT	ANT1	2-DH5	Hopping_LCH	-53.579	-22.518	Pass
NVNT	ANT1	2-DH5	2480.00	-57.672	-24.581	Pass
NVNT	ANT1	2-DH5	Hopping_HCH	-55.853	-23.930	Pass
NVNT	ANT1	3-DH5	2402.00	-54.265	-22.299	Pass
NVNT	ANT1	3-DH5	Hopping_LCH	-54.003	-22.061	Pass
NVNT	ANT1	3-DH5	2480.00	-53.058	-24.269	Pass
NVNT	ANT1	3-DH5	Hopping_HCH	-53.589	-22.664	Pass

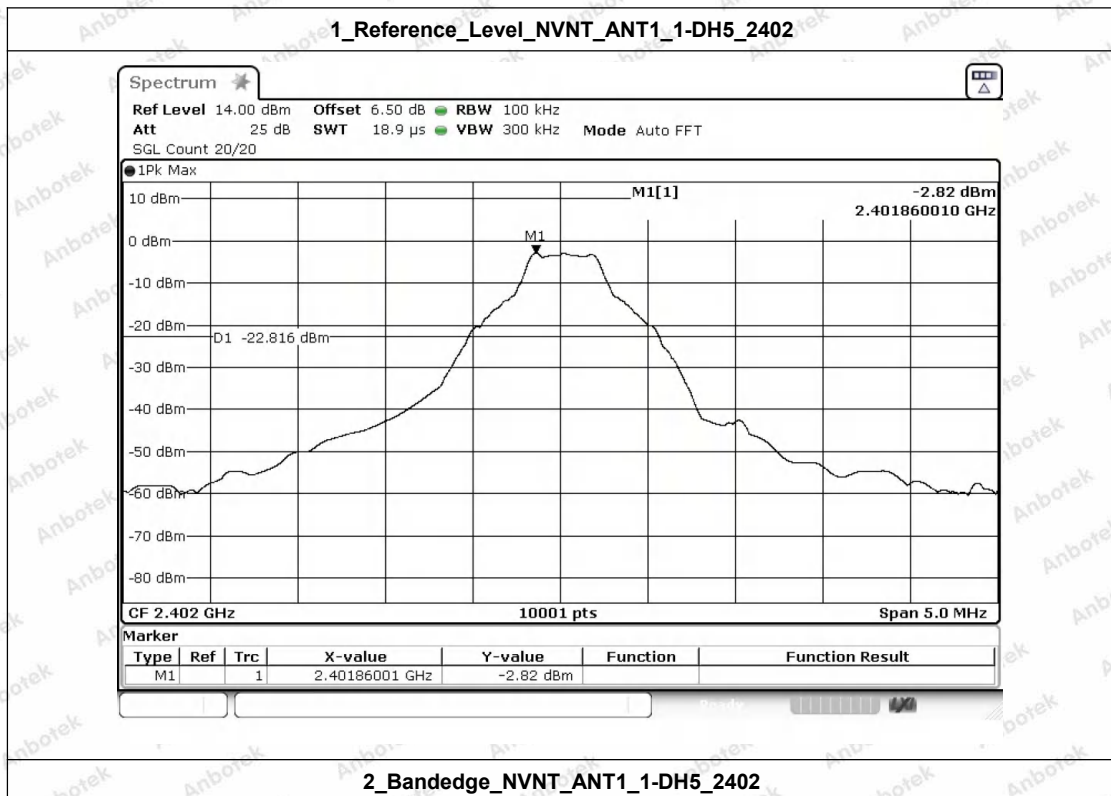

2_Bandedge_NVNT_ANT1_1-DH5_2402

Shenzhen Anbotek Compliance Laboratory Limited

Address: 1/F., Building D, Sogood Science and Technology Park, Sanwei Community, Hangcheng Street, Bao'an District, Shenzhen, Guangdong, China.
 Tel: (86) 0755-26066440 Fax: (86) 0755-26014772 Email: service@anbotek.com

Hotline
 400-003-0500
www.anbotek.com.cn



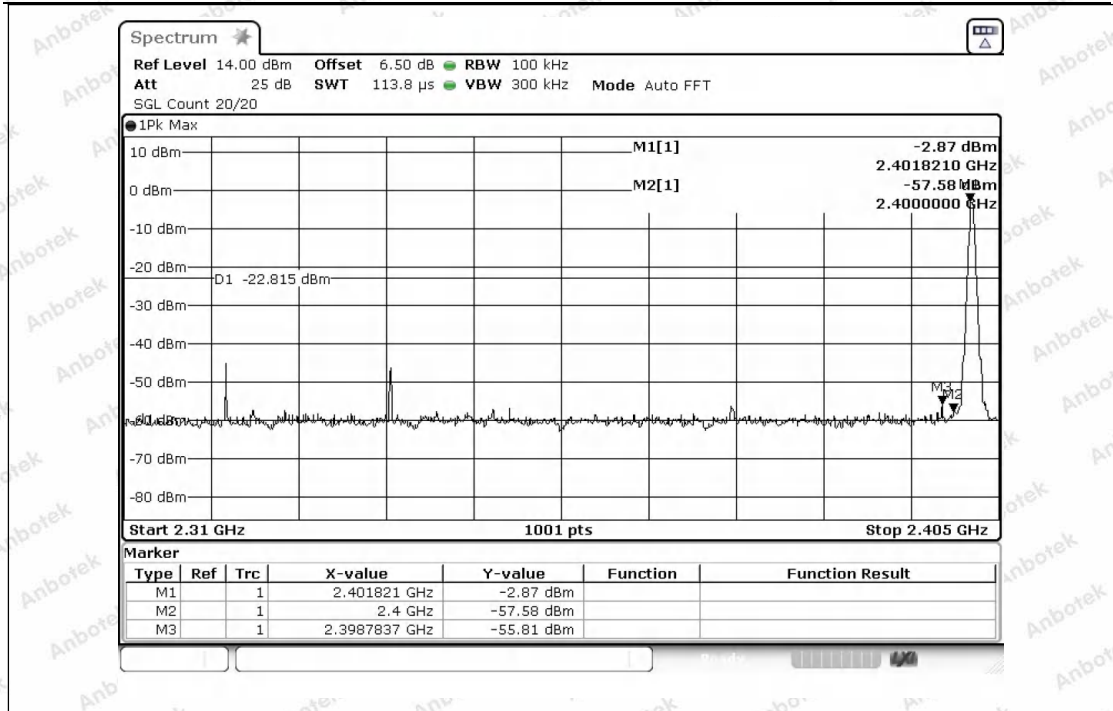

1_Reference_Level_Hopping_NVNT_ANT1_1-DH5_Hopping

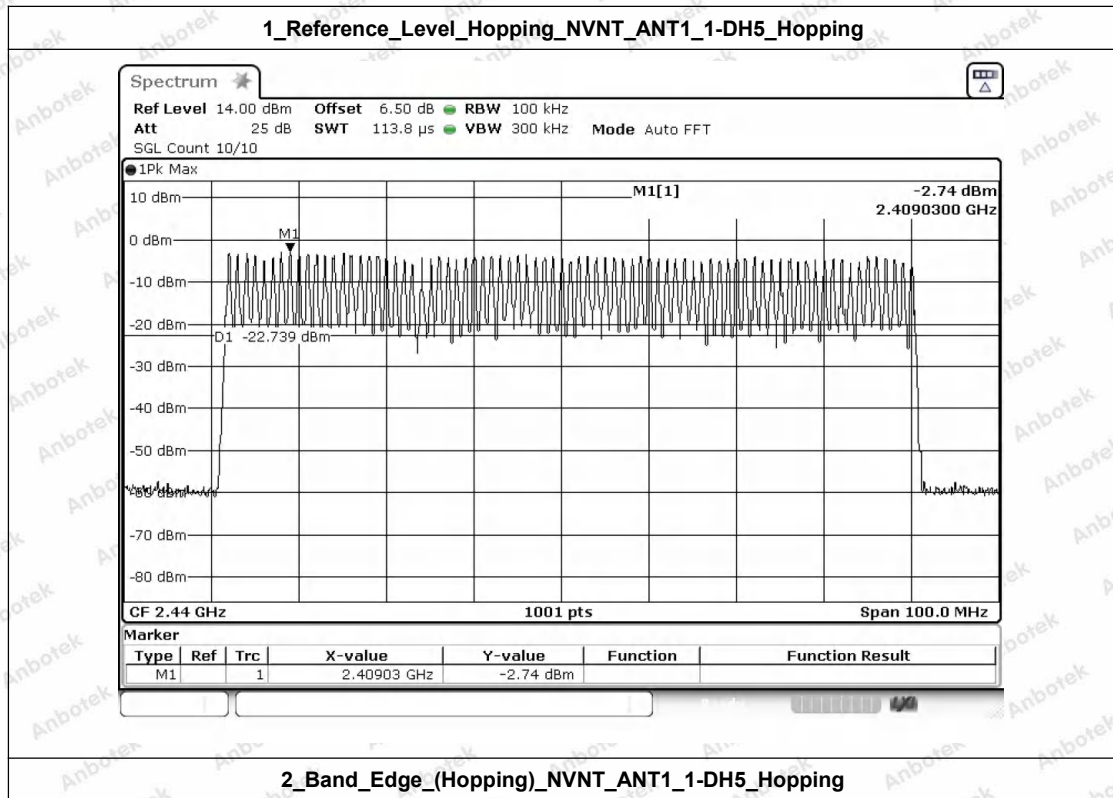

2_Band_Edge_(Hopping)_NVNT_ANT1_1-DH5_Hopping

Shenzhen Anbotek Compliance Laboratory Limited

Address: 1/F., Building D, Sogood Science and Technology Park, Sanwei Community, Hangcheng Street, Bao'an District, Shenzhen, Guangdong, China.
 Tel: (86) 0755-26066440 Fax: (86) 0755-26014772 Email: service@anbotek.com

Hotline 400-003-0500
 www.anbotek.com.cn



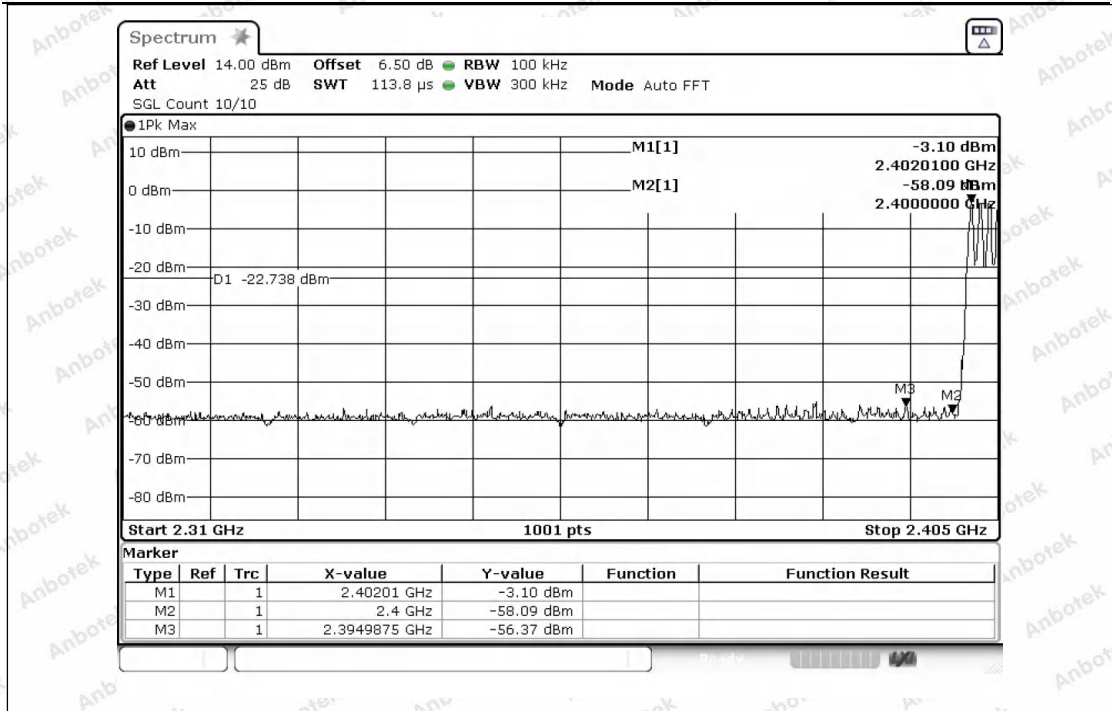

1_Reference_Level_NVNT_ANT1_1-DH5_2480

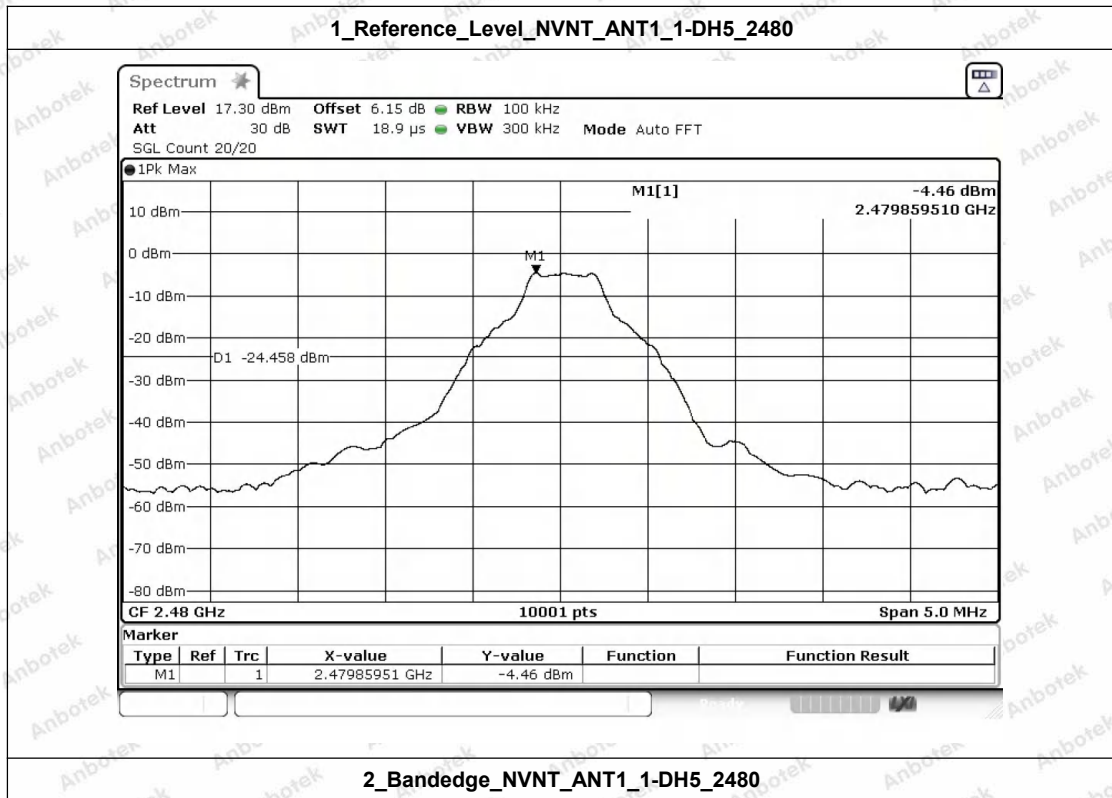

2_Bandedge_NVNT_ANT1_1-DH5_2480



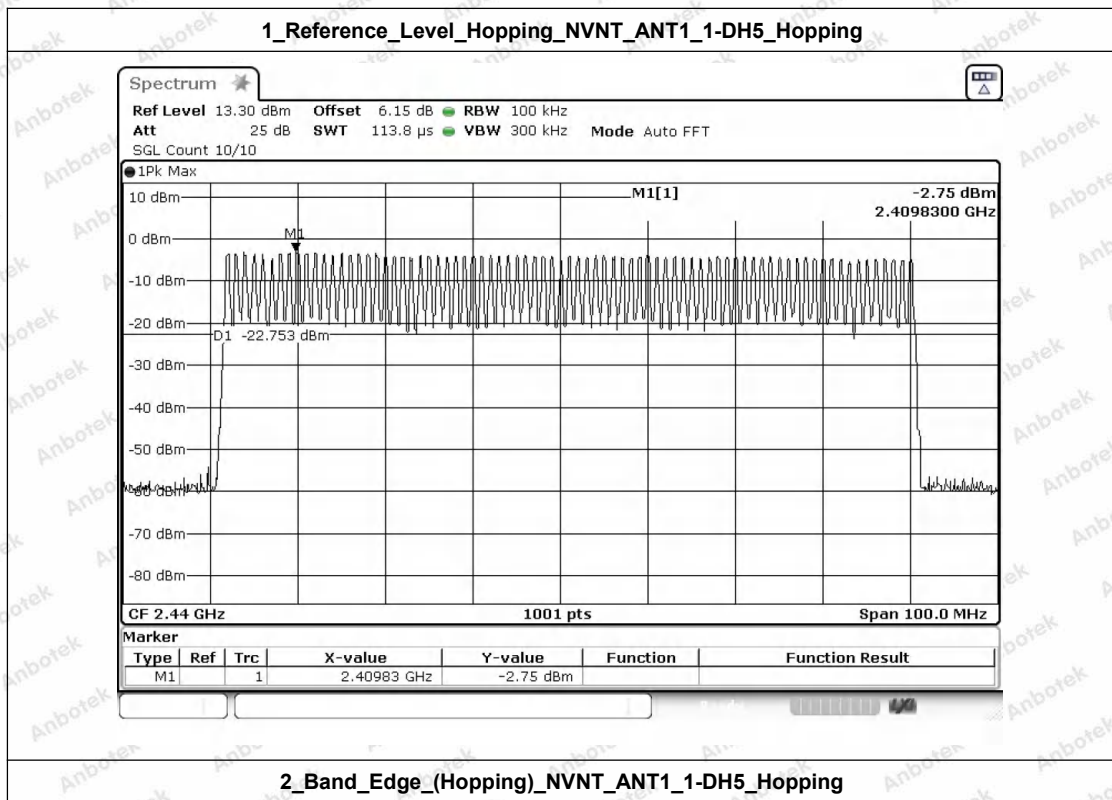
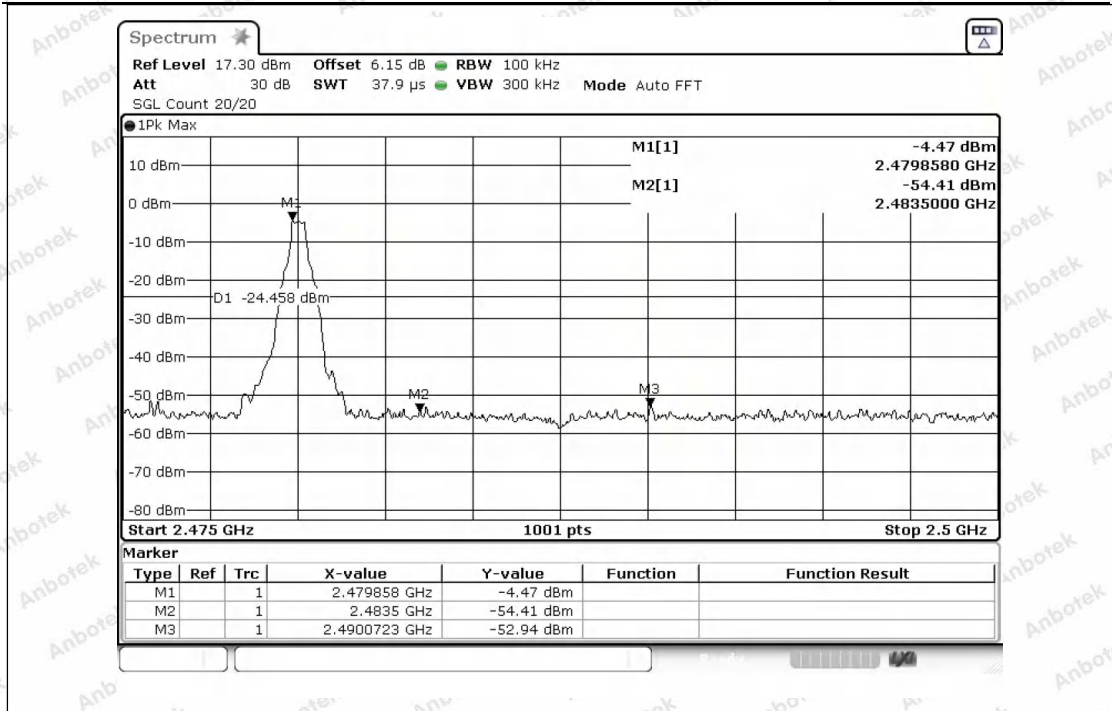

2_Band_Edge_(Hopping)_NVNT_ANT1_1-DH5_Hopping

Shenzhen Anbotek Compliance Laboratory Limited

Address: 1/F., Building D, Sogood Science and Technology Park, Sanwei Community, Hangcheng Street, Bao'an District, Shenzhen, Guangdong, China.
 Tel: (86) 0755-26066440 Fax: (86) 0755-26014772 Email: service@anbotek.com

Hotline
 400-003-0500
 www.anbotek.com.cn



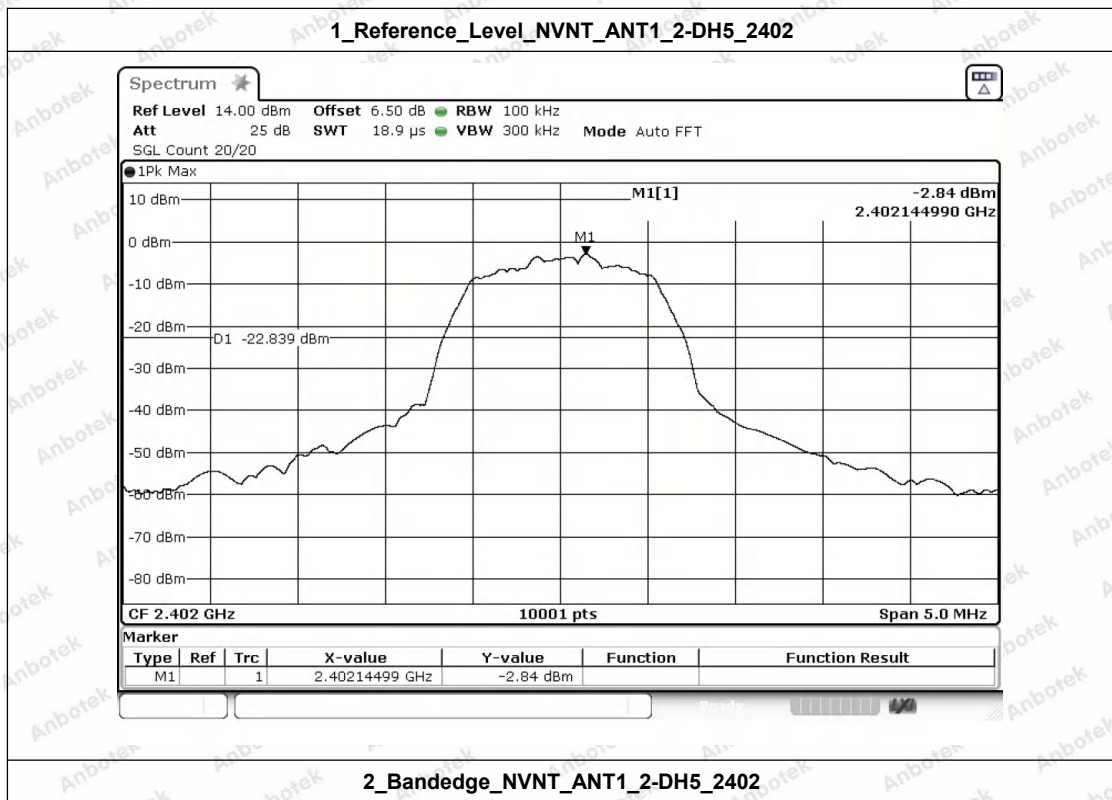
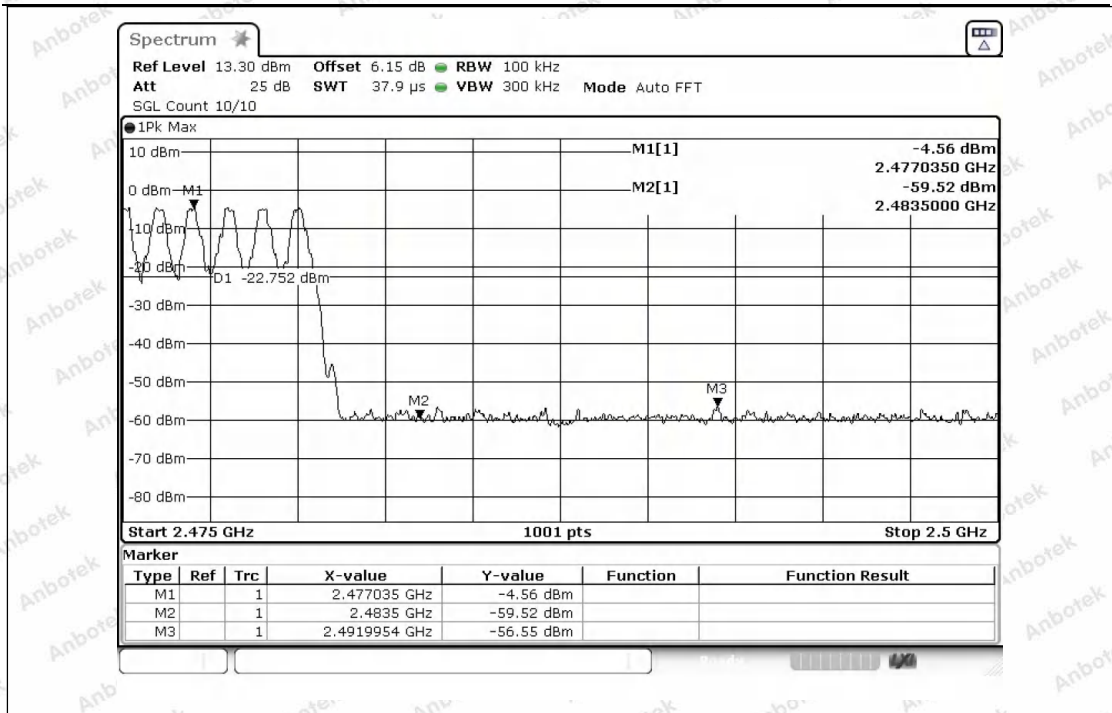

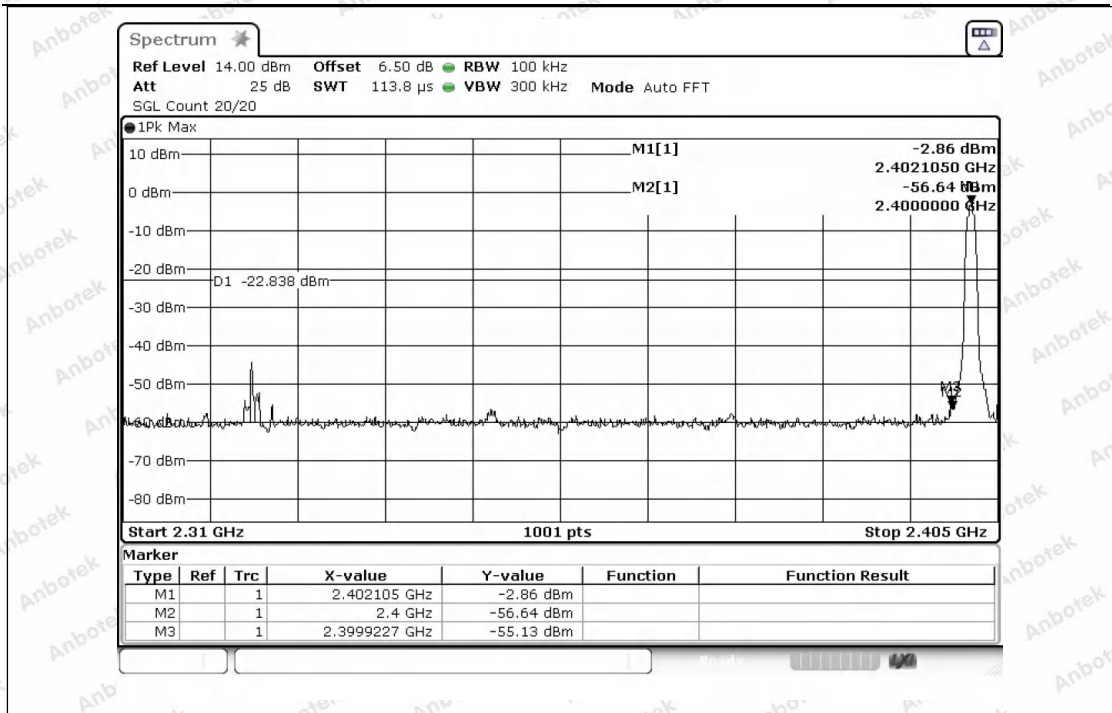

1_Reference_Level_Hopping_NVNT_ANT1_2-DH5_Hopping

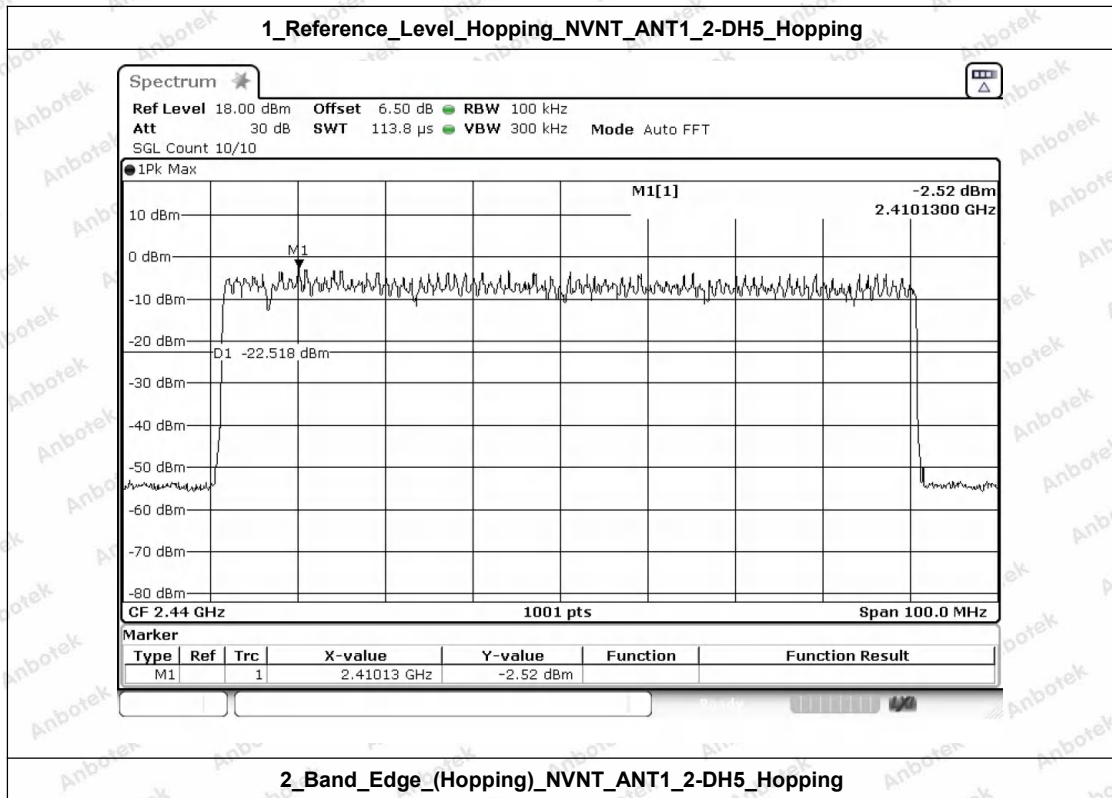

2_Band_Edge_(Hopping)_NVNT_ANT1_2-DH5_Hopping



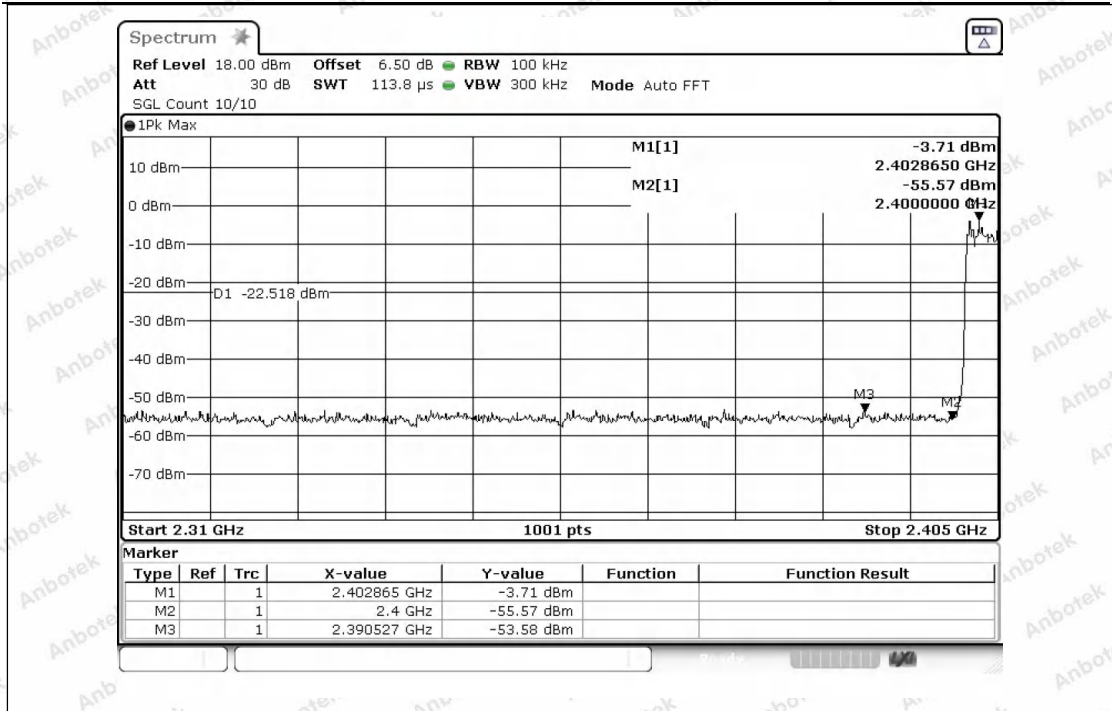

1_Reference_Level_NVNT_ANT1_2-DH5_2480

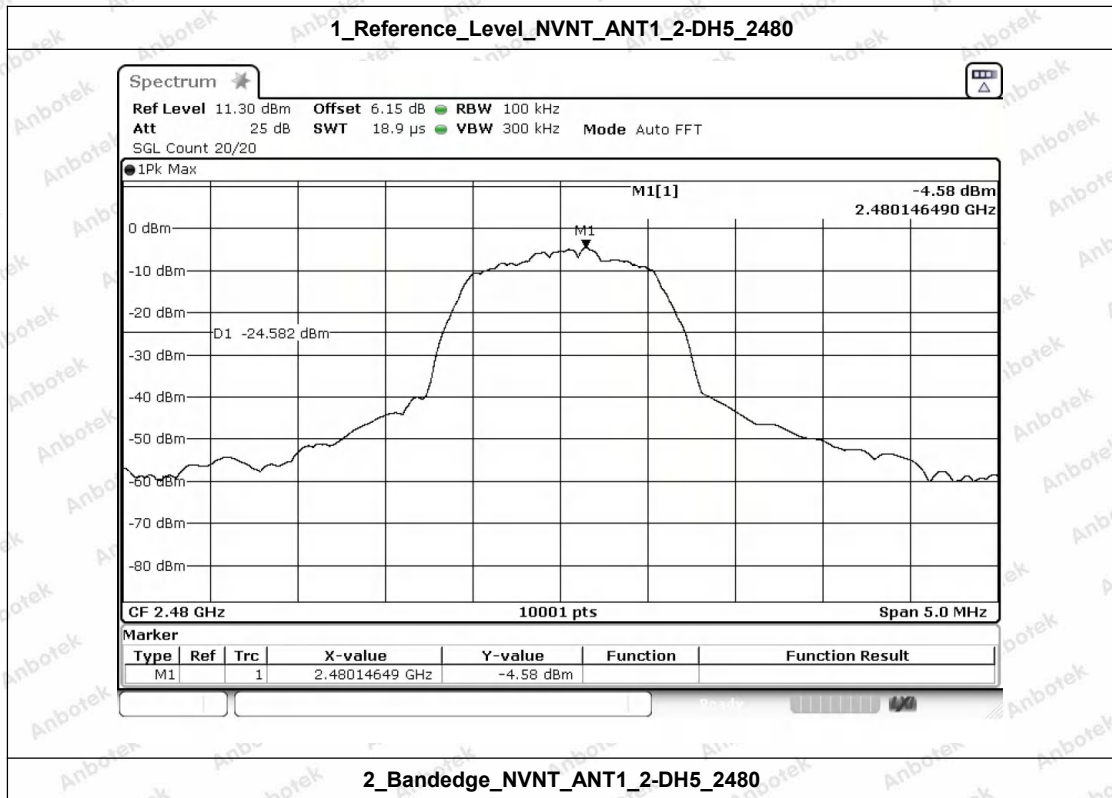

2_Bandedge_NVNT_ANT1_2-DH5_2480

Shenzhen Anbotek Compliance Laboratory Limited

Address: 1/F., Building D, Sogood Science and Technology Park, Sanwei Community, Hangcheng Street, Bao'an District, Shenzhen, Guangdong, China.
 Tel: (86) 0755-26066440 Fax: (86) 0755-26014772 Email: service@anbotek.com

Hotline 400-003-0500
 www.anbotek.com.cn



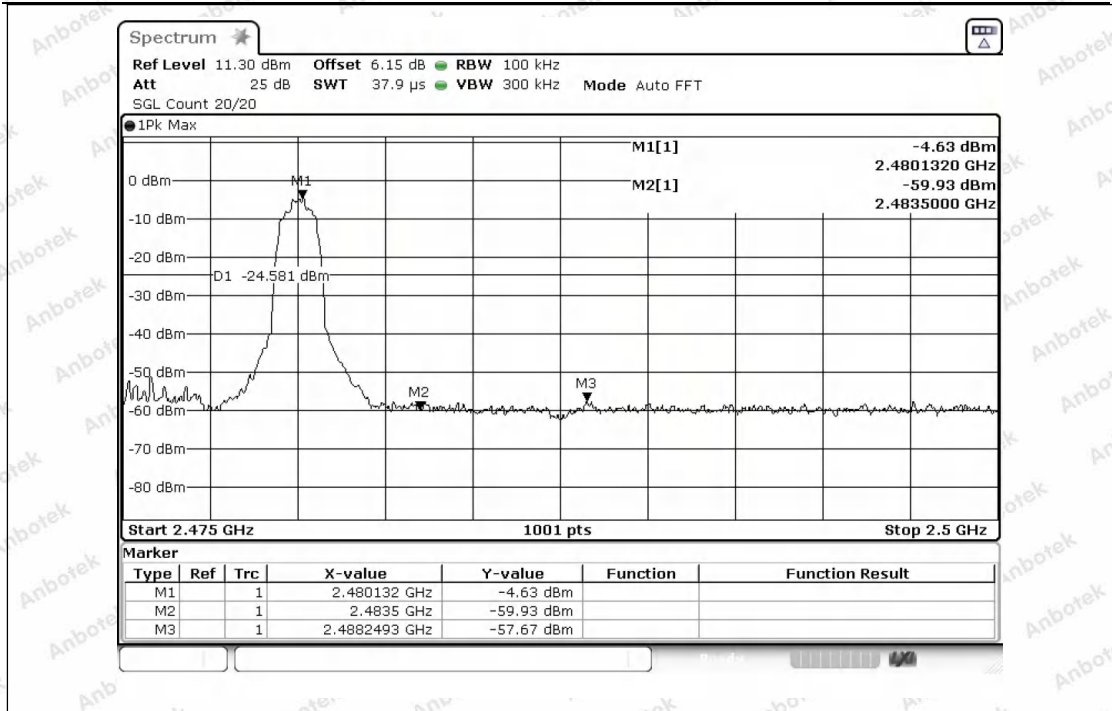

1_Reference_Level_Hopping_NVNT_ANT1_2-DH5_Hopping

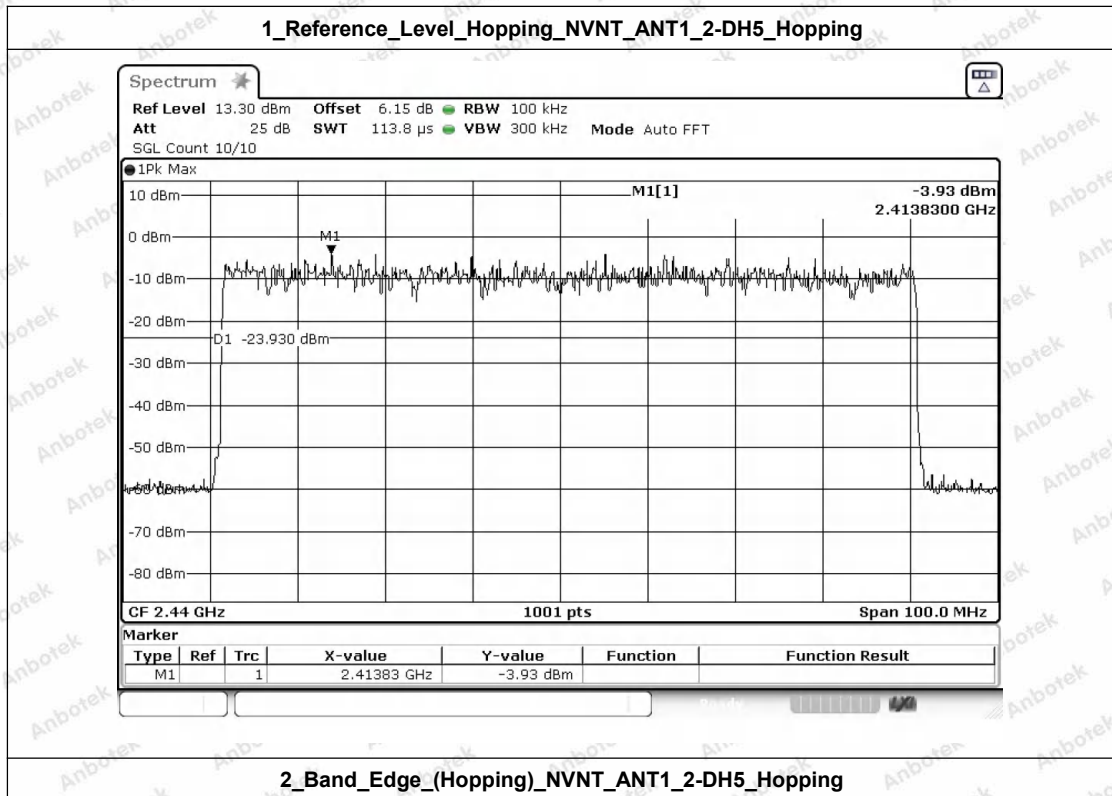

2_Band_Edge_(Hopping)_NVNT_ANT1_2-DH5_Hopping

Shenzhen Anbotek Compliance Laboratory Limited

Address: 1/F., Building D, Sogood Science and Technology Park, Sanwei Community, Hangcheng Street, Bao'an District, Shenzhen, Guangdong, China.
 Tel: (86) 0755-26066440 Fax: (86) 0755-26014772 Email: service@anbotek.com

Hotline
 400-003-0500
www.anbotek.com.cn



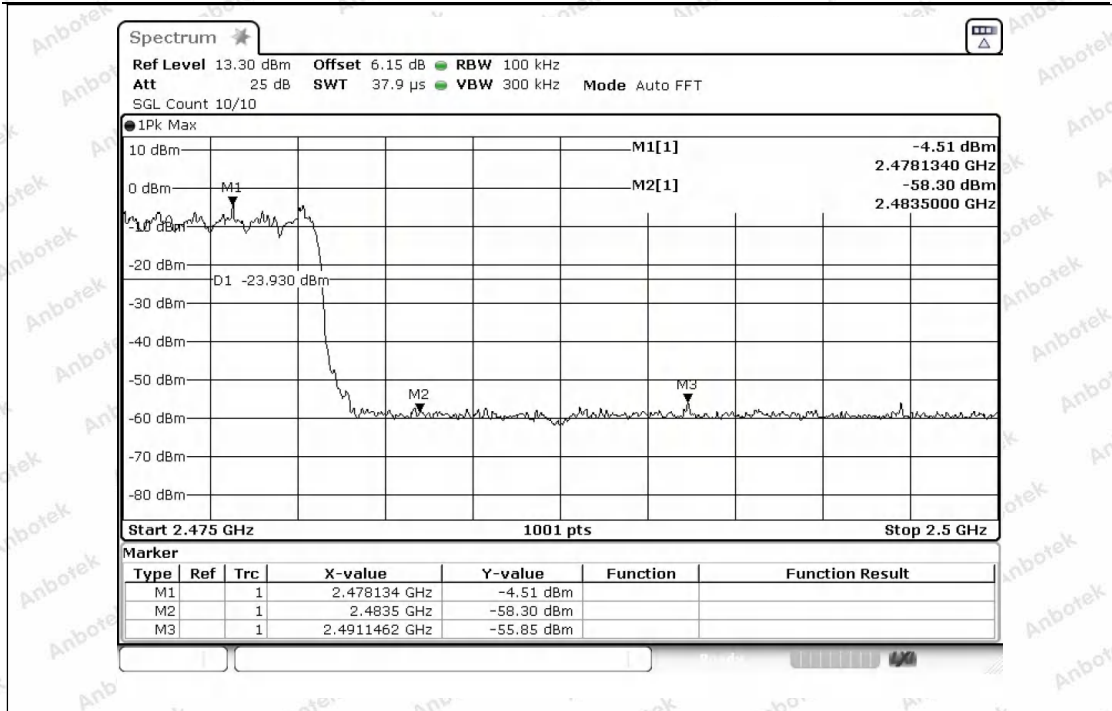

1_Reference_Level_NVNT_ANT1_3-DH5_2402

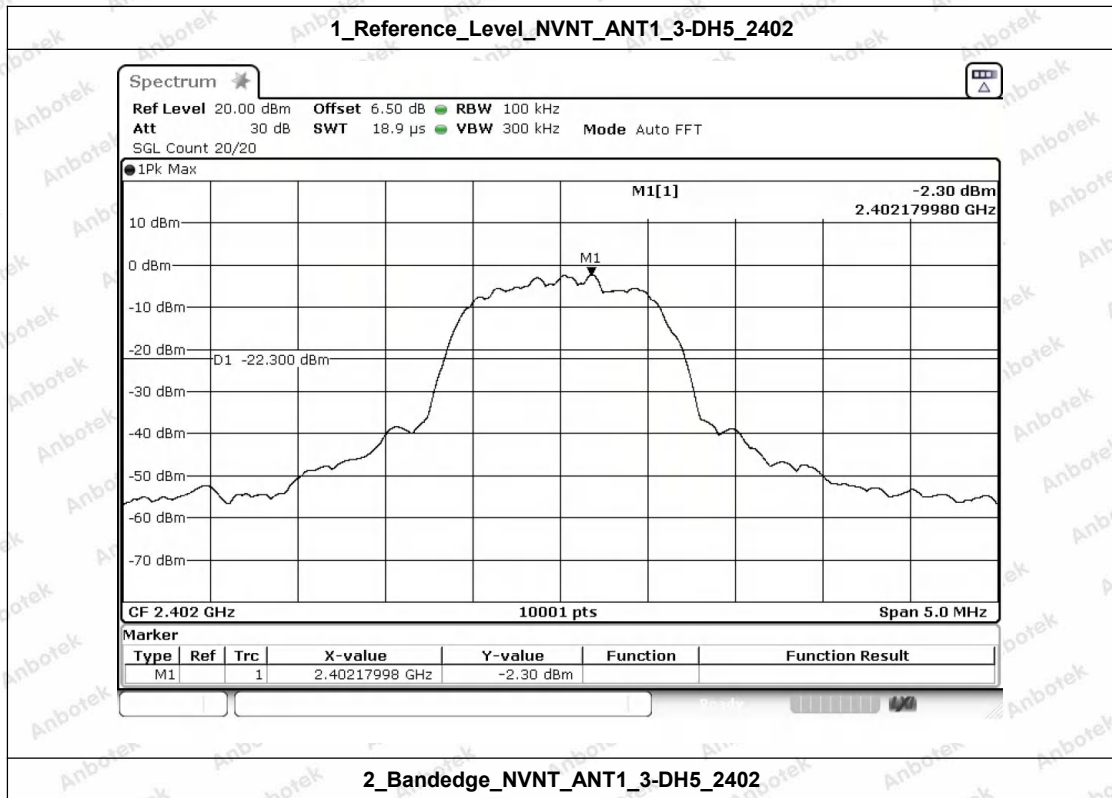

2_Bandedge_NVNT_ANT1_3-DH5_2402

Shenzhen Anbotek Compliance Laboratory Limited

Address: 1/F., Building D, Sogood Science and Technology Park, Sanwei Community, Hangcheng Street, Bao'an District, Shenzhen, Guangdong, China.
 Tel: (86) 0755-26066440 Fax: (86) 0755-26014772 Email: service@anbotek.com

Hotline 400-003-0500
 www.anbotek.com.cn



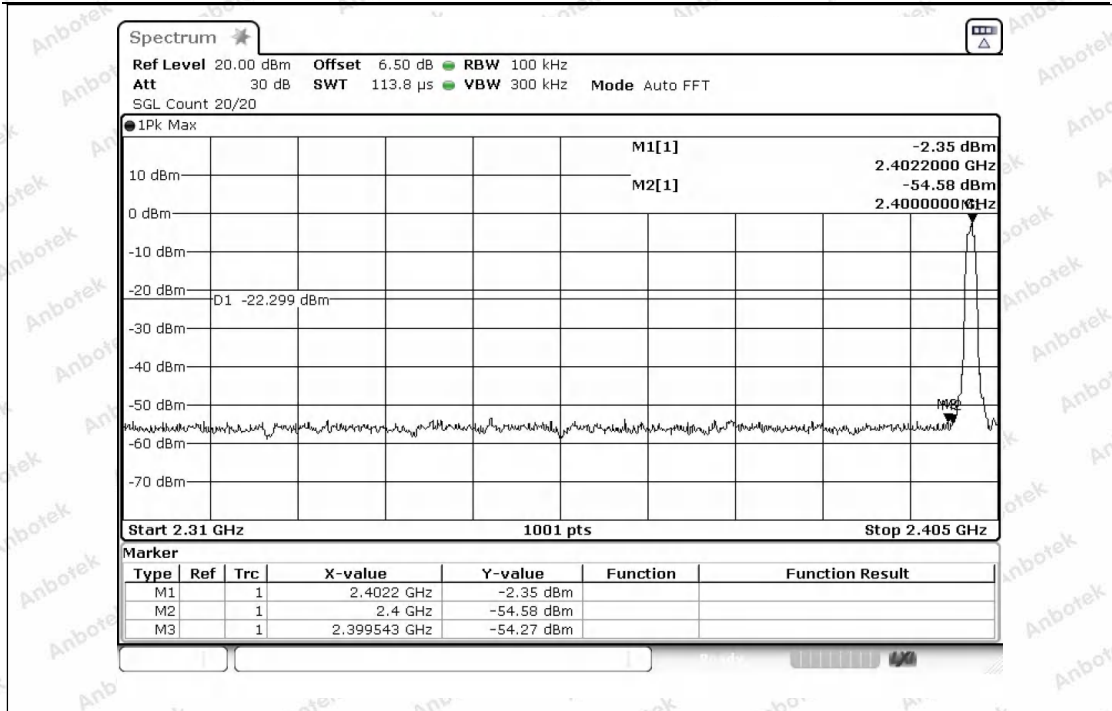

1_Reference_Level_Hopping_NVNT_ANT1_3-DH5_Hopping

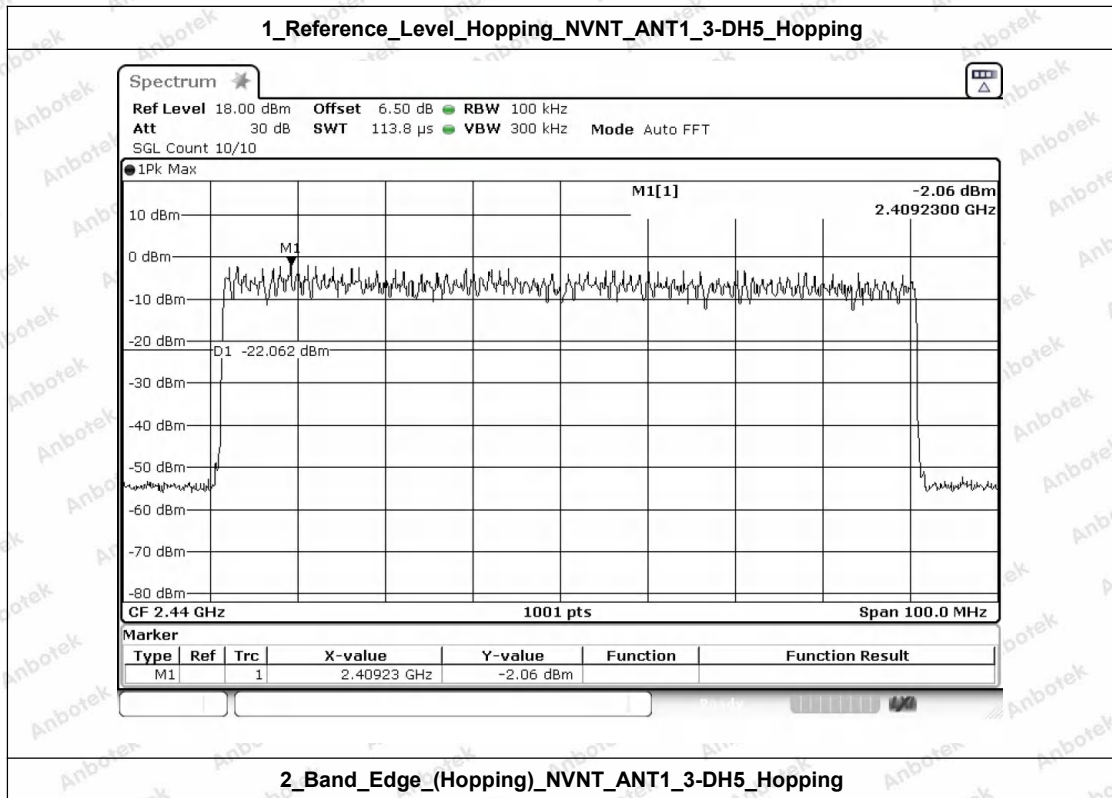

2_Band_Edge_(Hopping)_NVNT_ANT1_3-DH5_Hopping

Shenzhen Anbotek Compliance Laboratory Limited

Address: 1/F., Building D, Sogood Science and Technology Park, Sanwei Community, Hangcheng Street, Bao'an District, Shenzhen, Guangdong, China.
 Tel: (86) 0755-26066440 Fax: (86) 0755-26014772 Email: service@anbotek.com

Hotline
 400-003-0500
 www.anbotek.com.cn



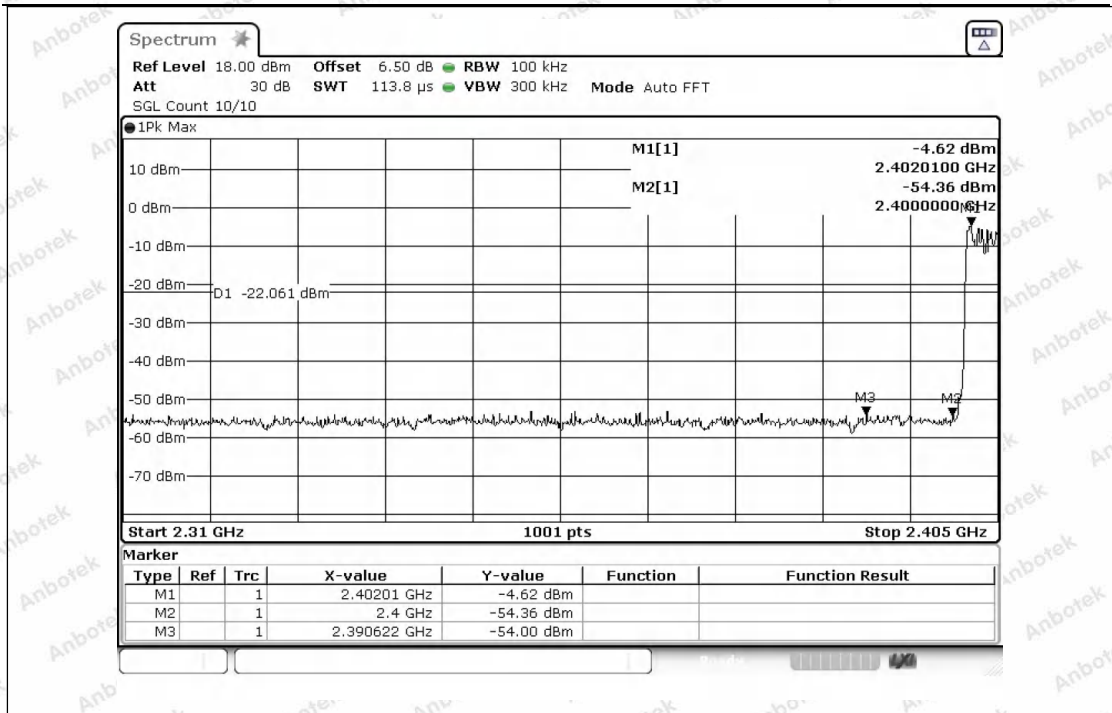

1_Reference_Level_NVNT_ANT1_3-DH5_2480

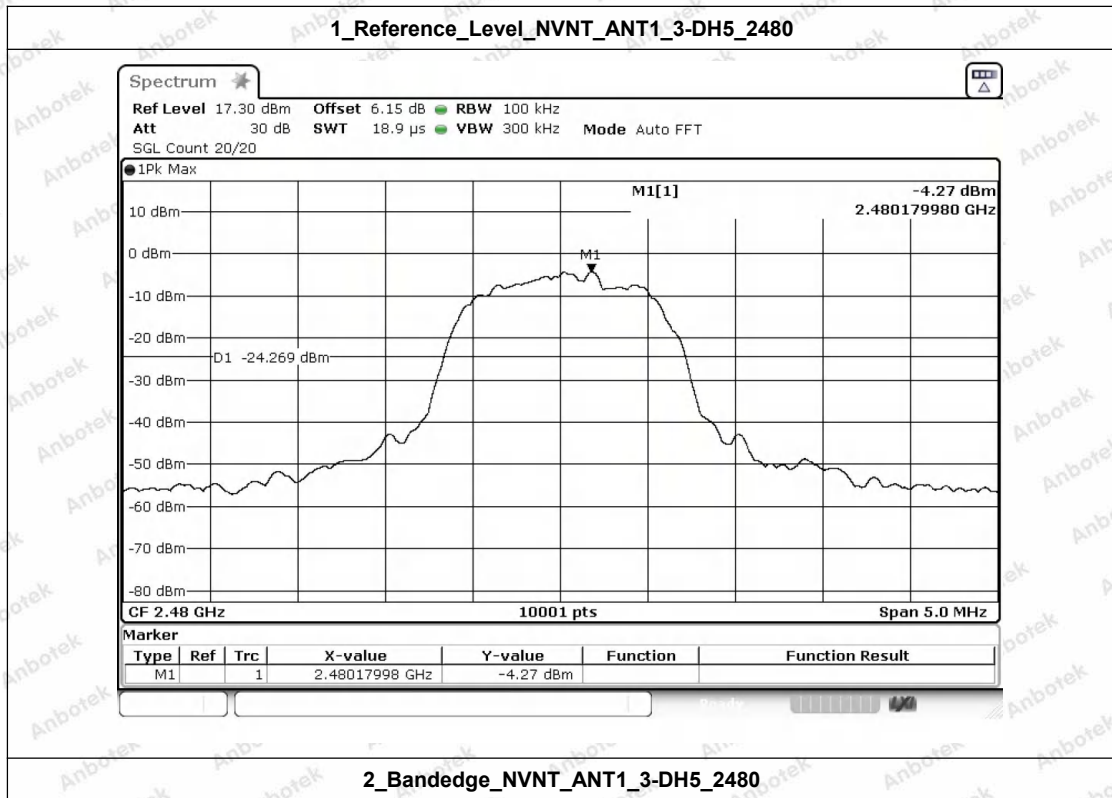

2_Bandedge_NVNT_ANT1_3-DH5_2480

Shenzhen Anbotek Compliance Laboratory Limited

Address: 1/F., Building D, Sogood Science and Technology Park, Sanwei Community, Hangcheng Street, Bao'an District, Shenzhen, Guangdong, China.
 Tel: (86) 0755-26066440 Fax: (86) 0755-26014772 Email: service@anbotek.com

 Hotline
 400-003-0500
www.anbotek.com.cn



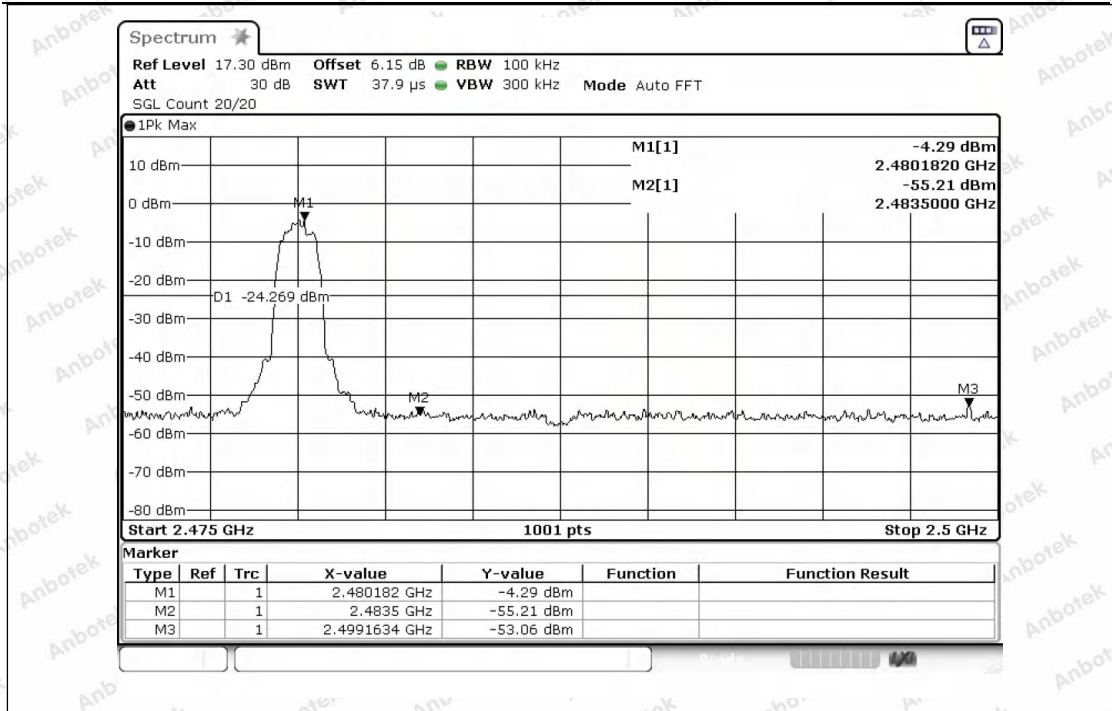

1_Reference_Level_Hopping_NVNT_ANT1_3-DH5_Hopping

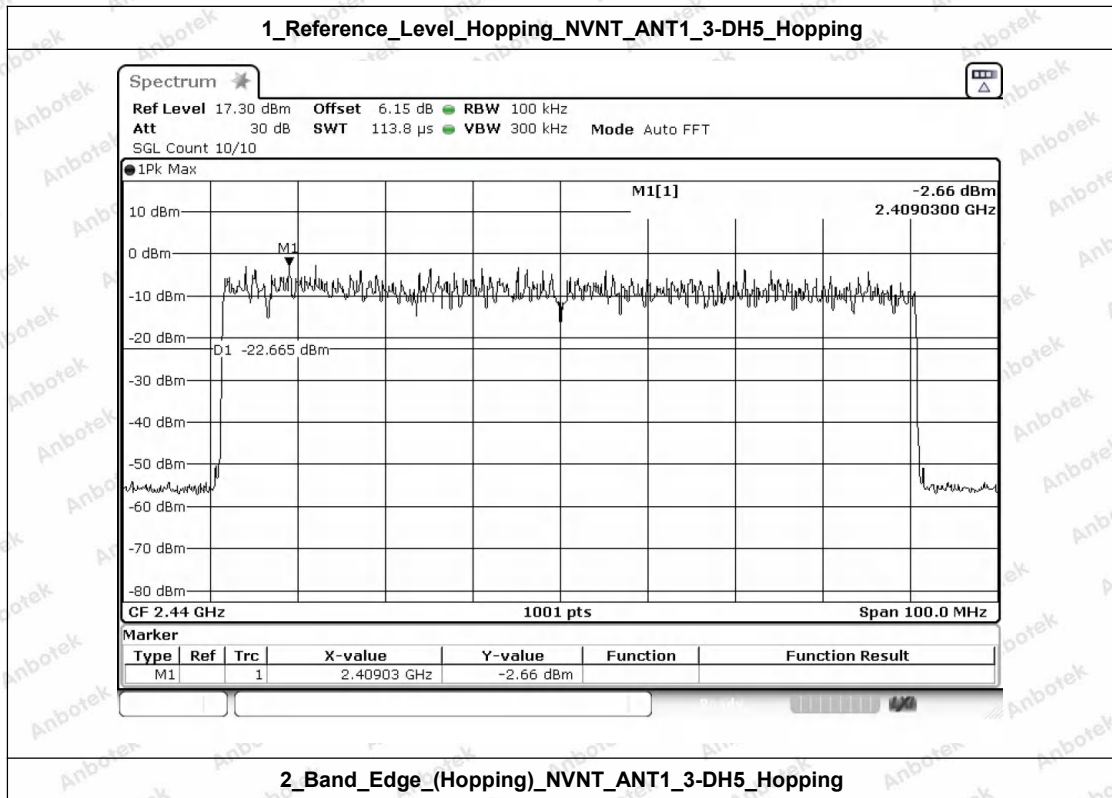

2_Band_Edge_(Hopping)_NVNT_ANT1_3-DH5_Hopping

Shenzhen Anbotek Compliance Laboratory Limited

Address: 1/F., Building D, Sogood Science and Technology Park, Sanwei Community, Hangcheng Street, Bao'an District, Shenzhen, Guangdong, China.
 Tel: (86) 0755-26066440 Fax: (86) 0755-26014772 Email: service@anbotek.com

 Hotline
 400-003-0500
www.anbotek.com.cn



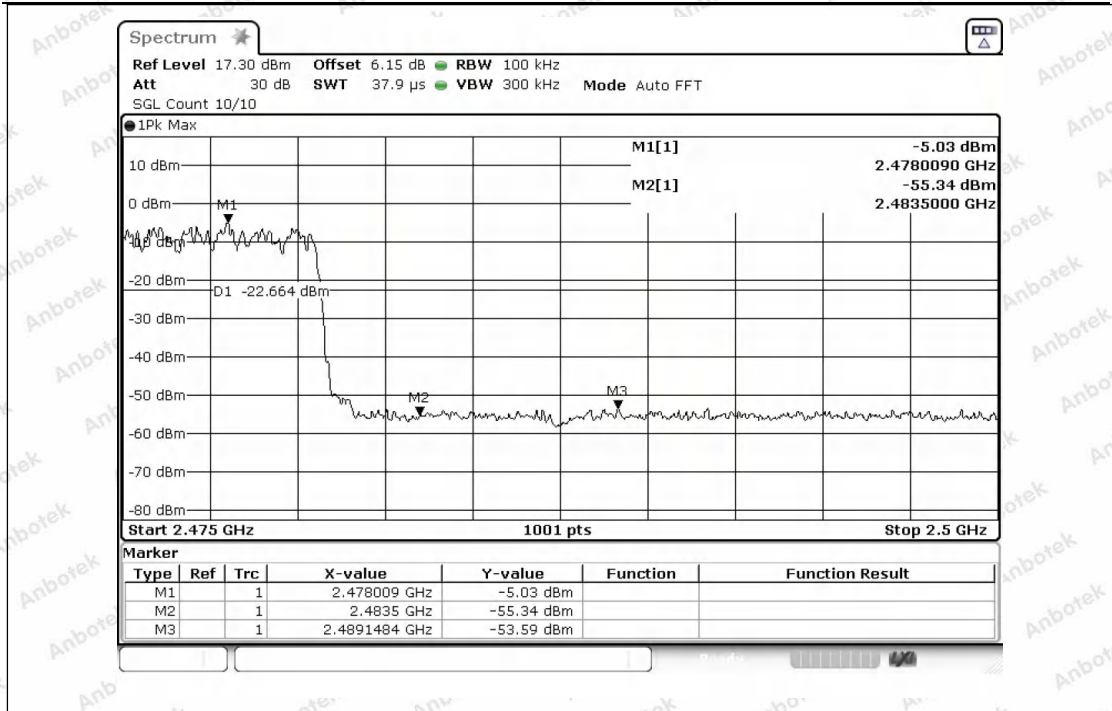

Shenzhen Anbotek Compliance Laboratory Limited

Address: 1/F., Building D, Sogood Science and Technology Park, Sanwei Community, Hangcheng Street, Bao'an District, Shenzhen, Guangdong, China.
 Tel: (86) 0755-26066440 Fax: (86) 0755-26014772 Email: service@anbotek.com



Hotline
 400-003-0500
 www.anbotek.com.cn



Appendix F: Carrier Frequencies Separation (Hopping)

Condition	Antenna	Modulation	Frequency(MHz)	Hopping NO.0 (MHz)	Hopping NO.1 (MHz)	Carrier Frequencies Separation(MHz)	Limit(MHz)	Result
NVNT	ANT1	1-DH5	2441.00	2440.862	2441.860	1.00	0.962	Pass
NVNT	ANT1	2-DH5	2441.00	2441.029	2442.144	1.11	0.877	Pass
NVNT	ANT1	3-DH5	2441.00	2441.044	2442.180	1.14	0.859	Pass

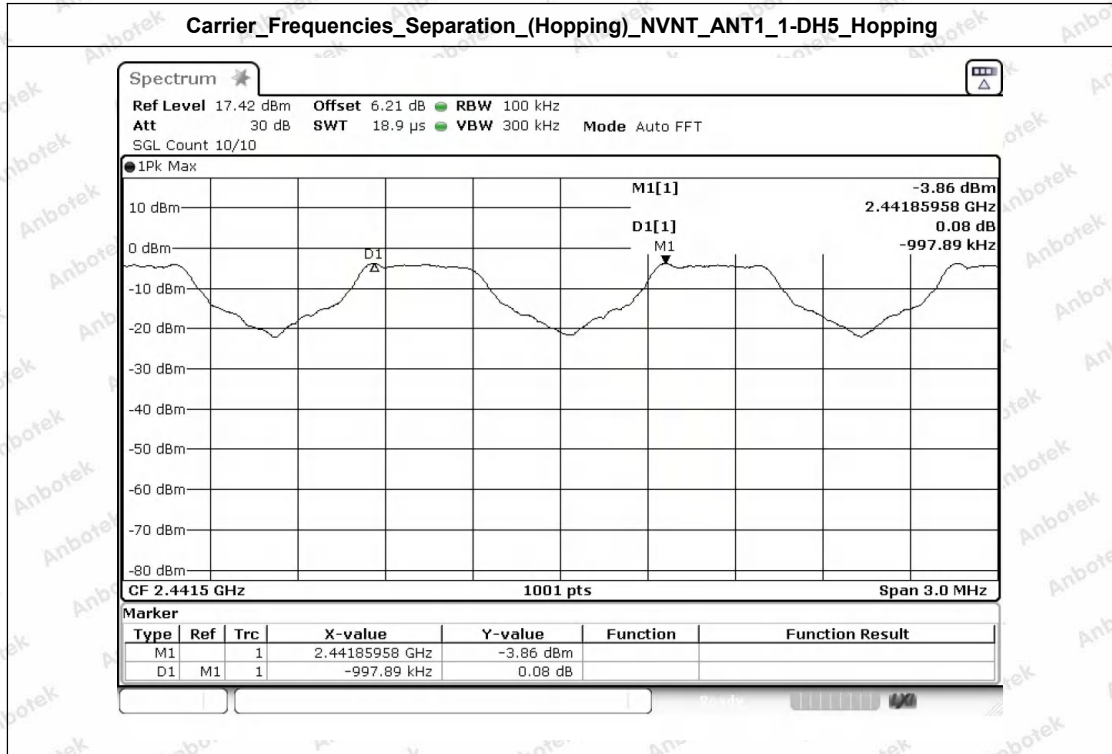

Carrier_Frequencies_Separation_(Hopping)_NVNT_ANT1_2-DH5_Hopping



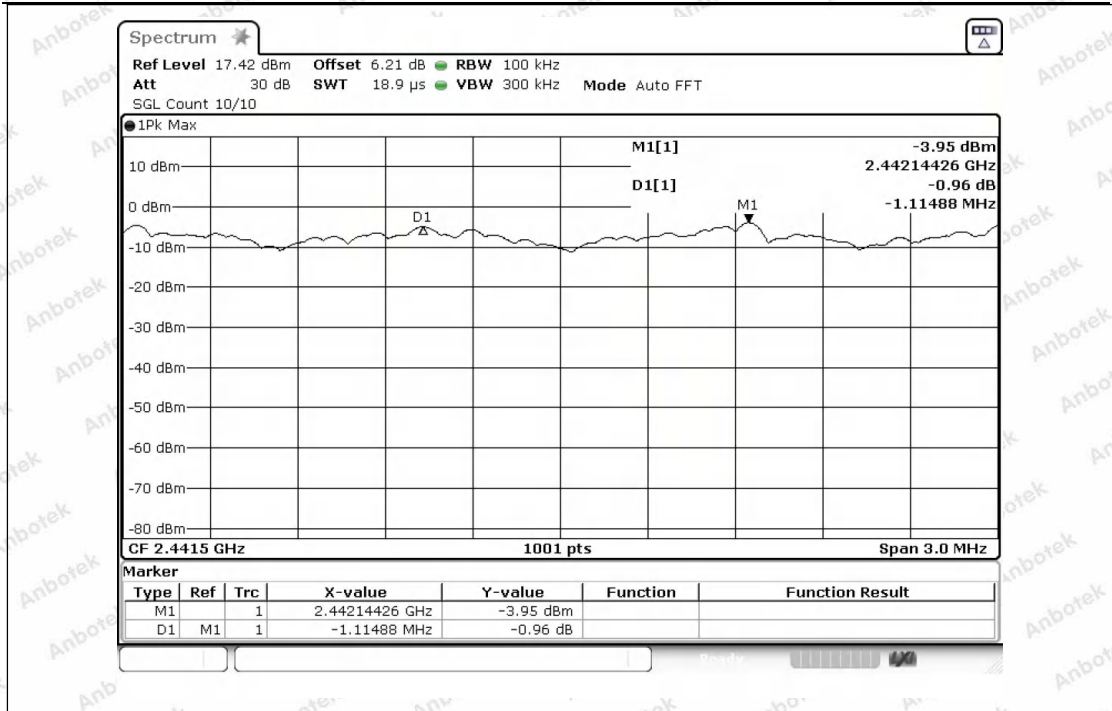

Carrier_Frequencies_Separation_(Hopping)_NVNT_ANT1_3-DH5_Hopping

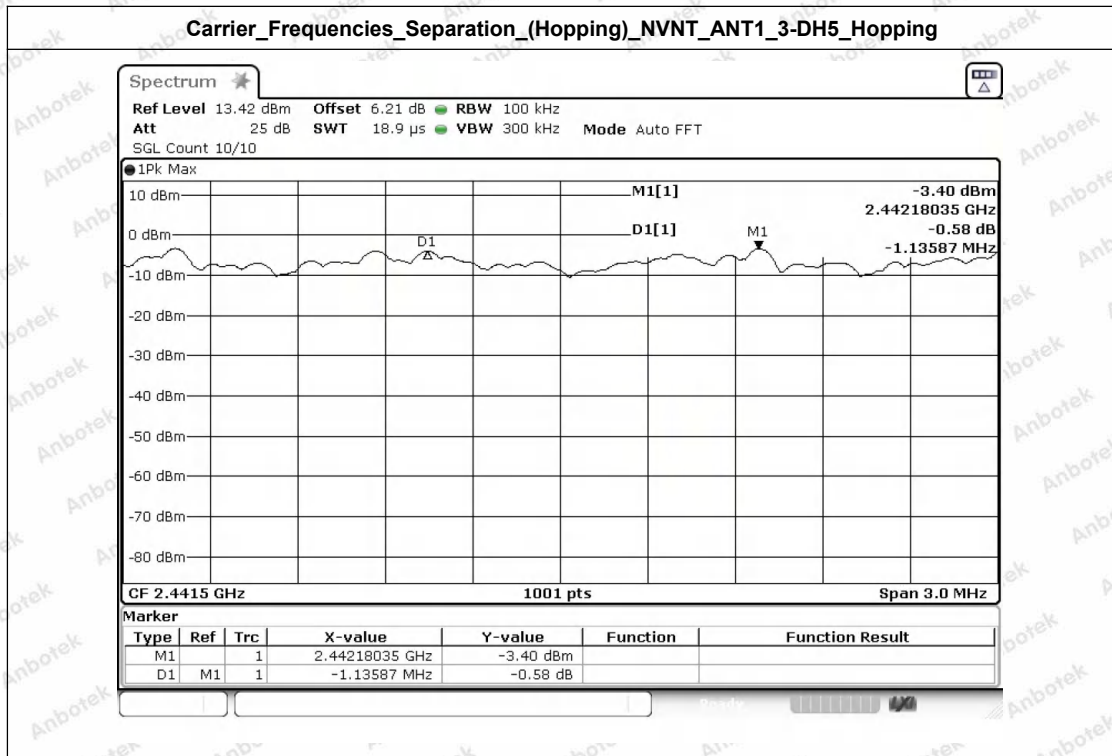

Shenzhen Anbotek Compliance Laboratory Limited

Address: 1/F., Building D, Sogood Science and Technology Park, Sanwei Community, Hangcheng Street, Bao'an District, Shenzhen, Guangdong, China.
 Tel: (86) 0755-26066440 Fax: (86) 0755-26014772 Email: service@anbotek.com

Hotline 400-003-0500
 www.anbotek.com.cn



Appendix G: Number of Hopping Channel (Hopping)

Condition	Antenna	Modulation	Hopping Num	Limit	Result
NVNT	ANT1	1-DH5	79	15	Pass
NVNT	ANT1	2-DH5	79	15	Pass
NVNT	ANT1	3-DH5	79	15	Pass

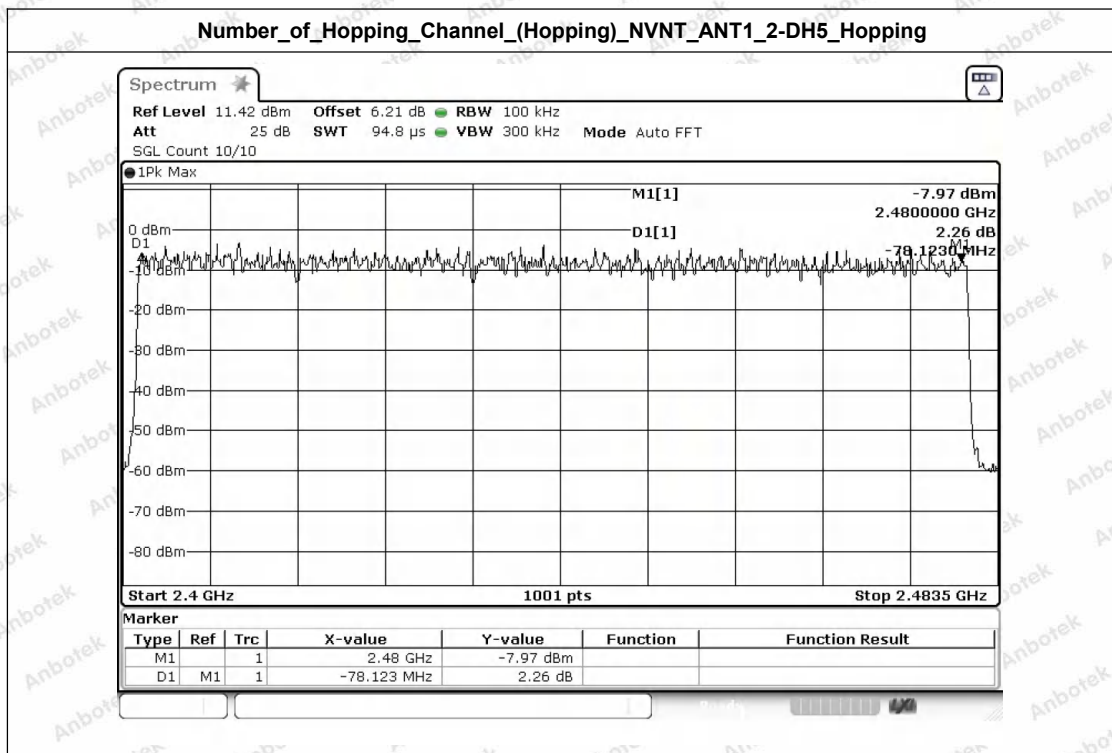
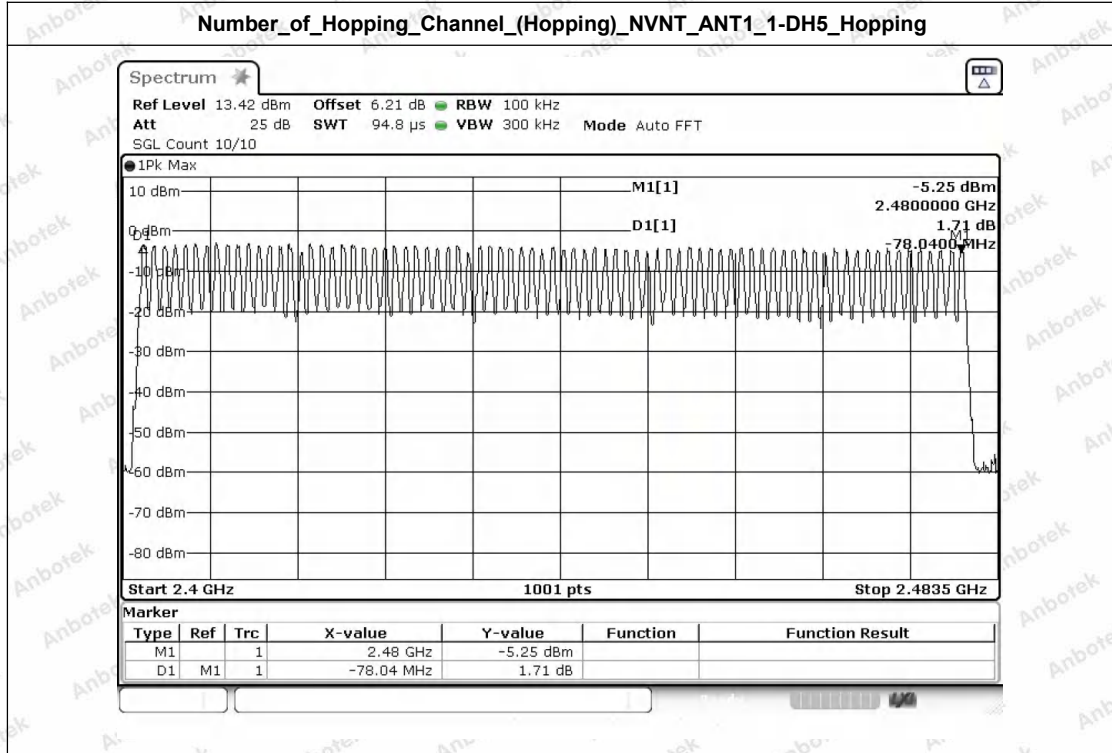

Shenzhen Anbotek Compliance Laboratory Limited

Address: 1/F., Building D, Sogood Science and Technology Park, Sanwei Community, Hangcheng Street, Bao'an District, Shenzhen, Guangdong, China.
 Tel: (86) 0755-26066440 Fax: (86) 0755-26014772 Email: service@anbotek.com

Hotline
 400-003-0500
www.anbotek.com.cn



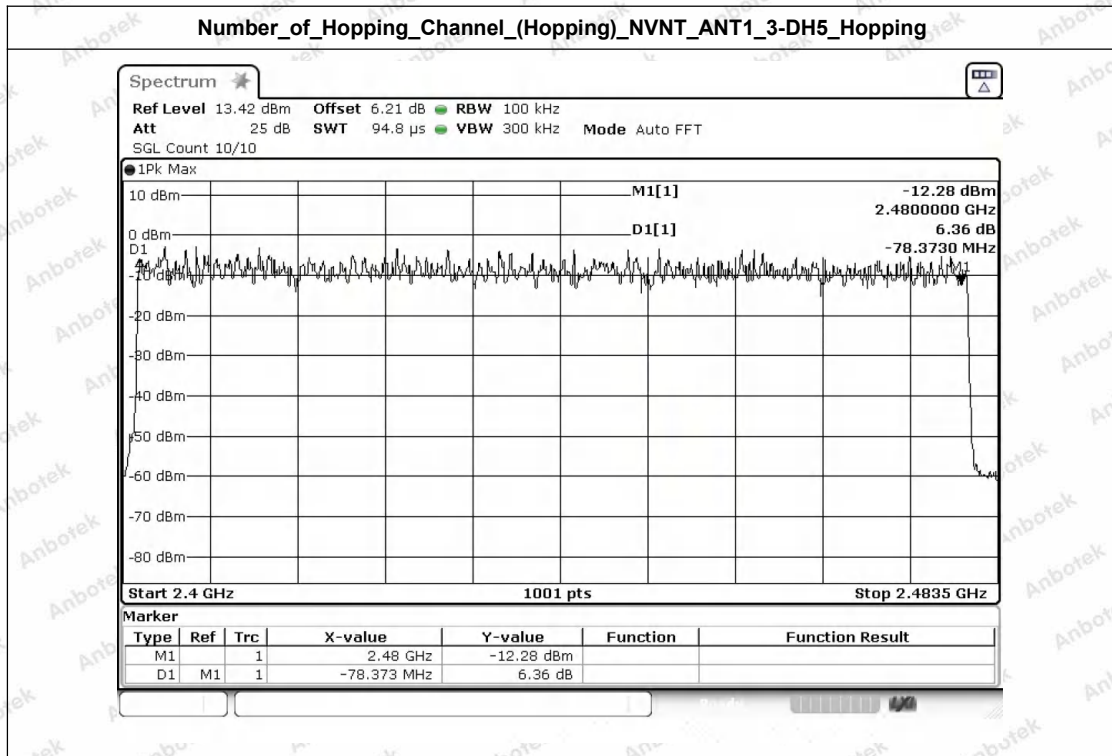

Shenzhen Anbotek Compliance Laboratory Limited

Address: 1/F., Building D, Sogood Science and Technology Park, Sanwei Community, Hangcheng Street, Bao'an District, Shenzhen, Guangdong, China.
 Tel: (86) 0755-26066440 Fax: (86) 0755-26014772 Email: service@anbotek.com

Hotline 400-003-0500
 www.anbotek.com.cn



Appendix H: Dwell Time (Hopping)

Condition	Antenna	Packet Type	Pulse Time(ms)	Hops	Dwell Time(ms)	Limit(s)	Result
NVNT	ANT1	1-DH5	2.900	111.00	321.900	0.40	Pass
NVNT	ANT1	2-DH5	2.910	106.00	308.460	0.40	Pass
NVNT	ANT1	3-DH5	2.910	113.00	328.830	0.40	Pass
NVNT	ANT1	1-DH1	0.410	320.00	131.200	0.40	Pass
NVNT	ANT1	1-DH3	1.670	150.00	250.500	0.40	Pass
NVNT	ANT1	2-DH1	0.400	320.00	128.000	0.40	Pass
NVNT	ANT1	2-DH3	1.660	172.00	285.520	0.40	Pass
NVNT	ANT1	3-DH1	0.410	319.00	130.790	0.40	Pass
NVNT	ANT1	3-DH3	1.660	149.00	247.340	0.40	Pass

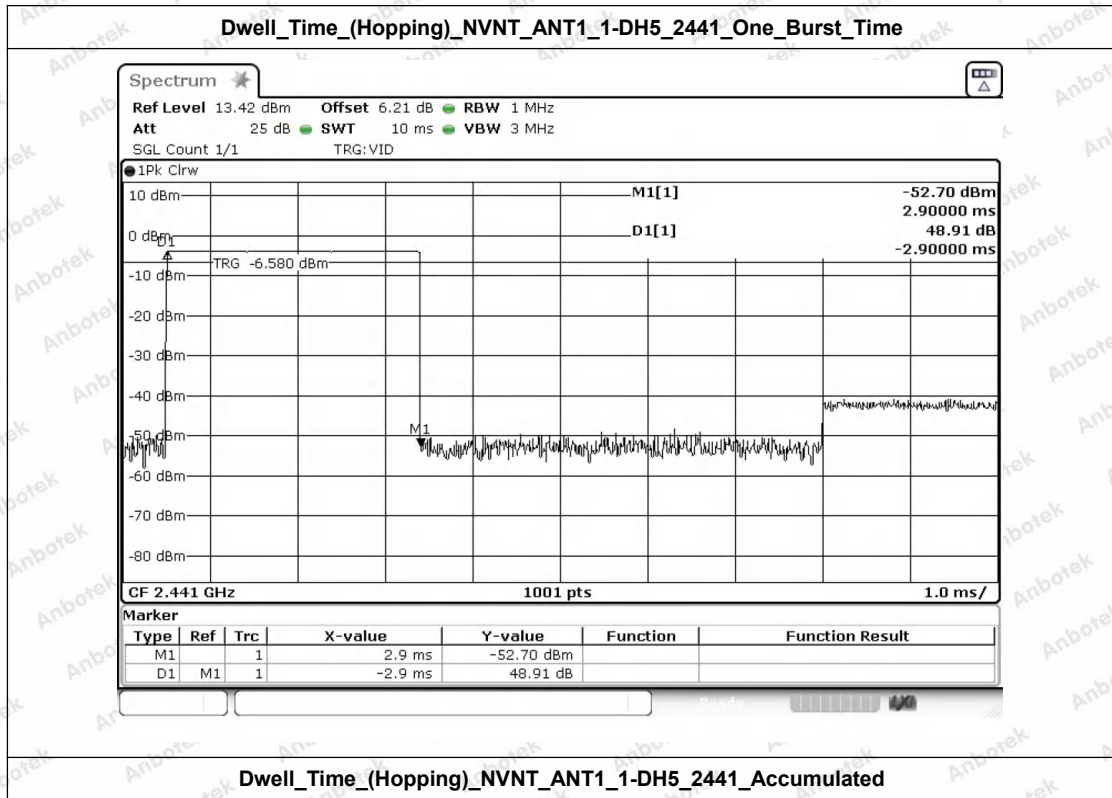

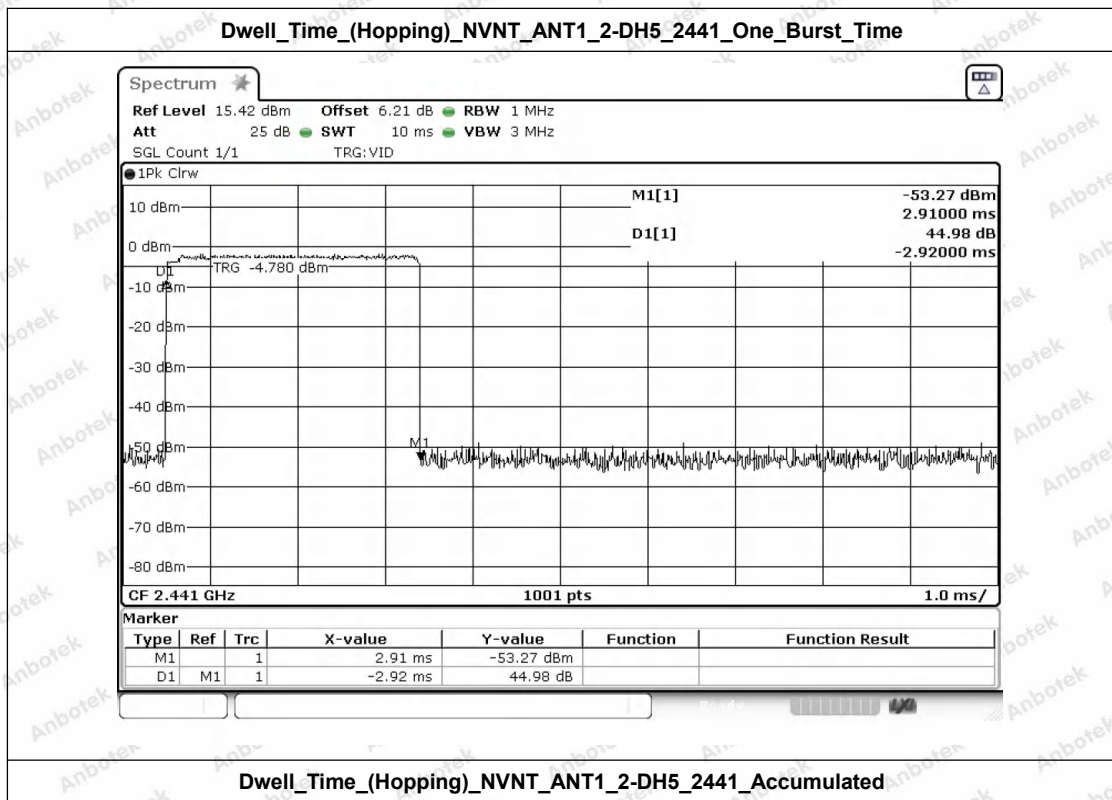
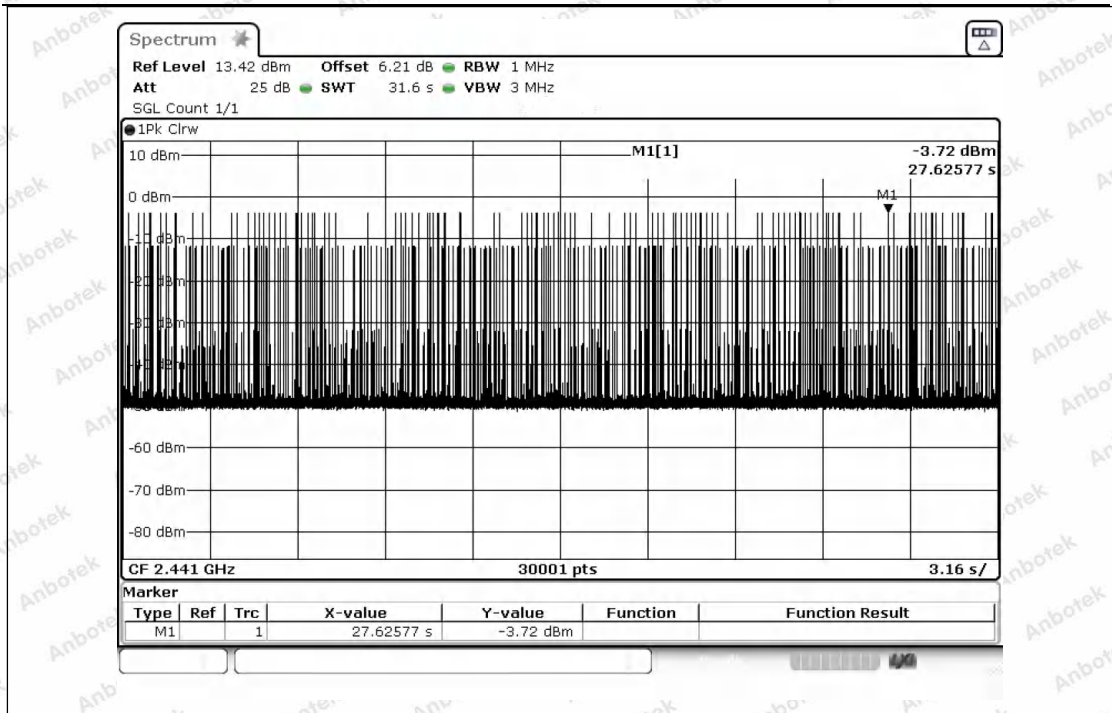

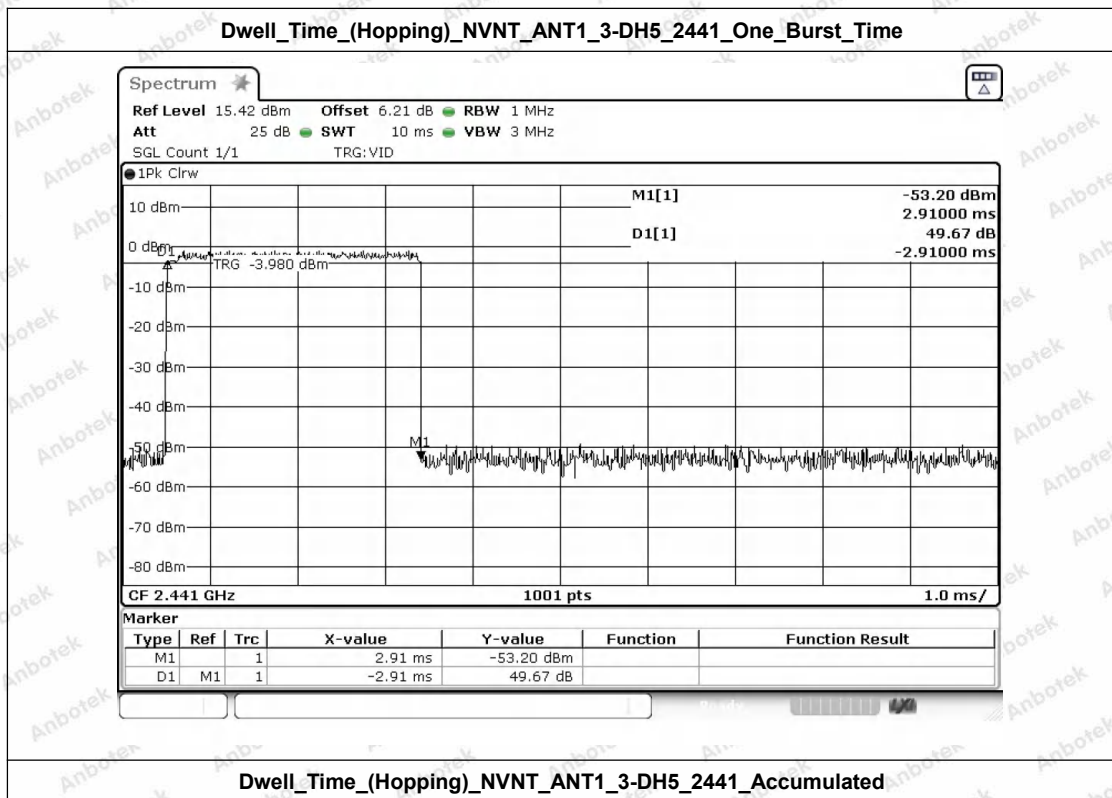
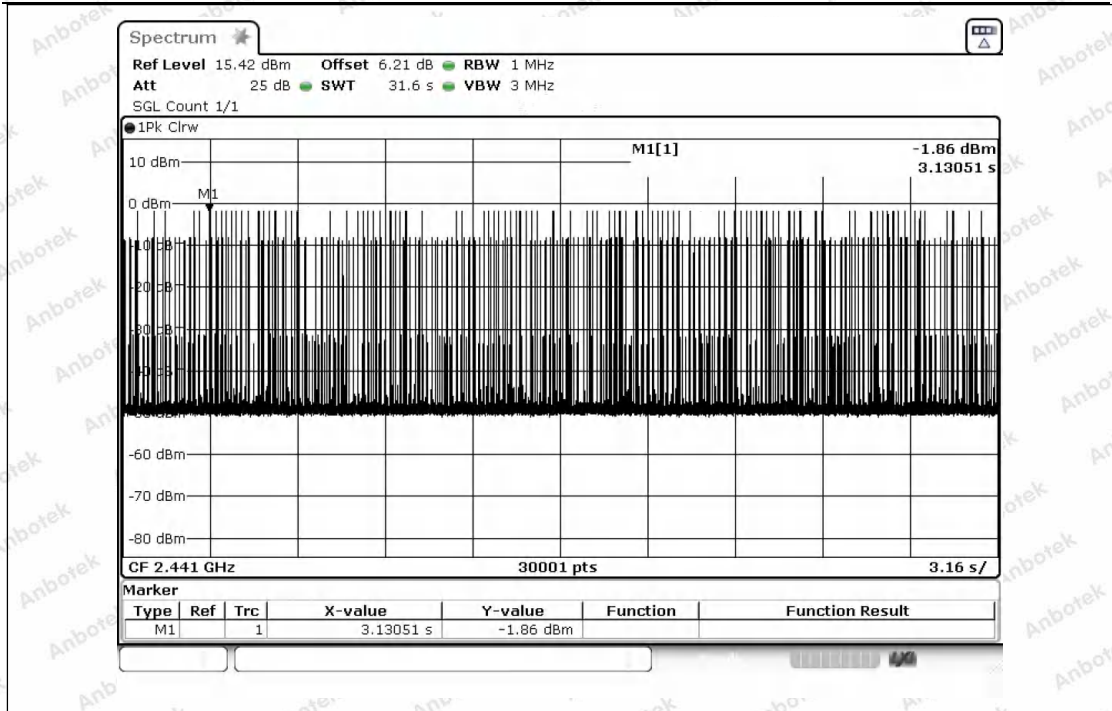

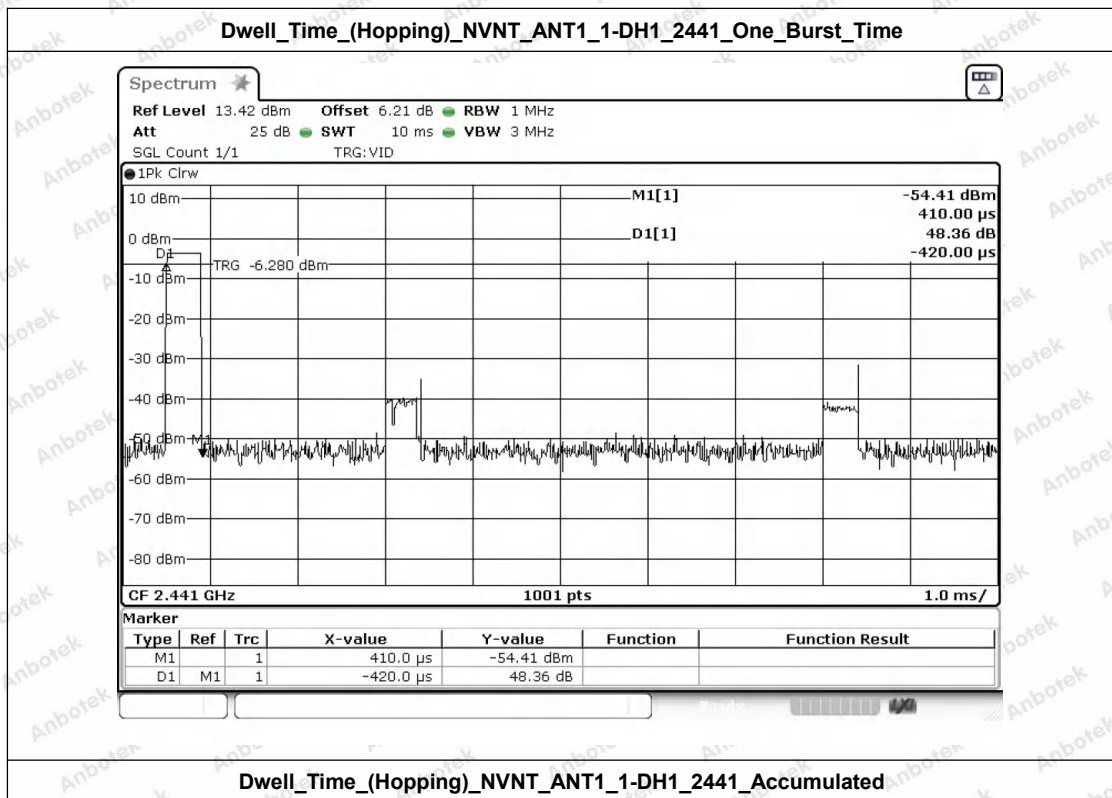
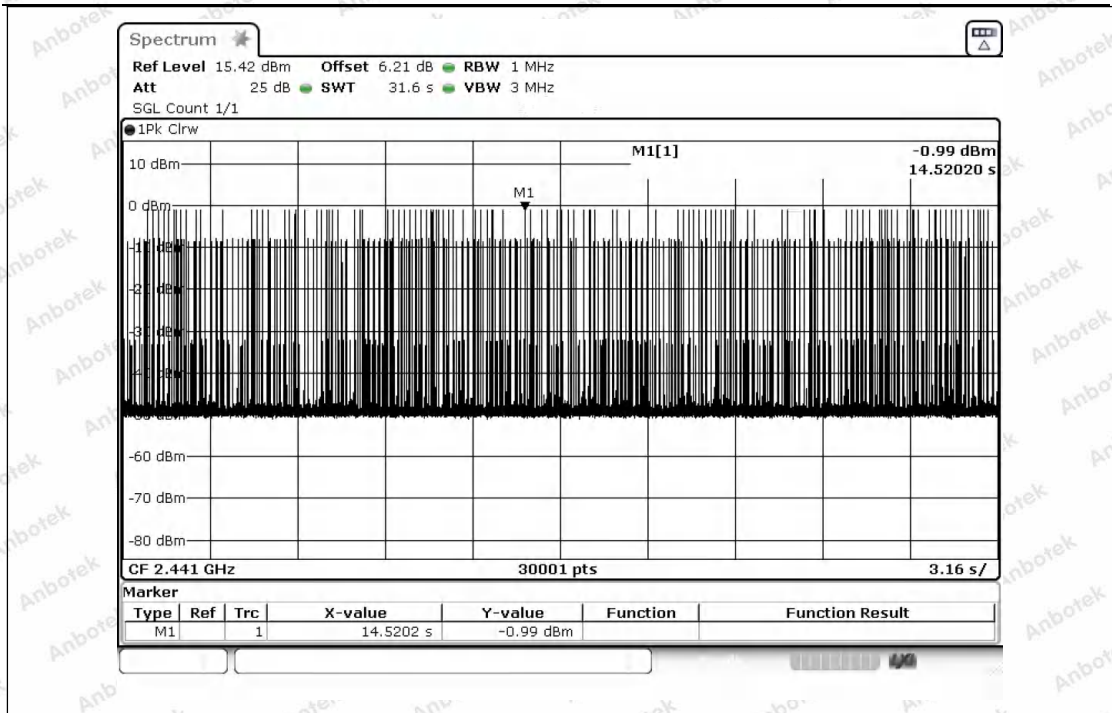

Dwell_Time_(Hopping)_NVNT_ANT1_1-DH1_2441_Accumulated



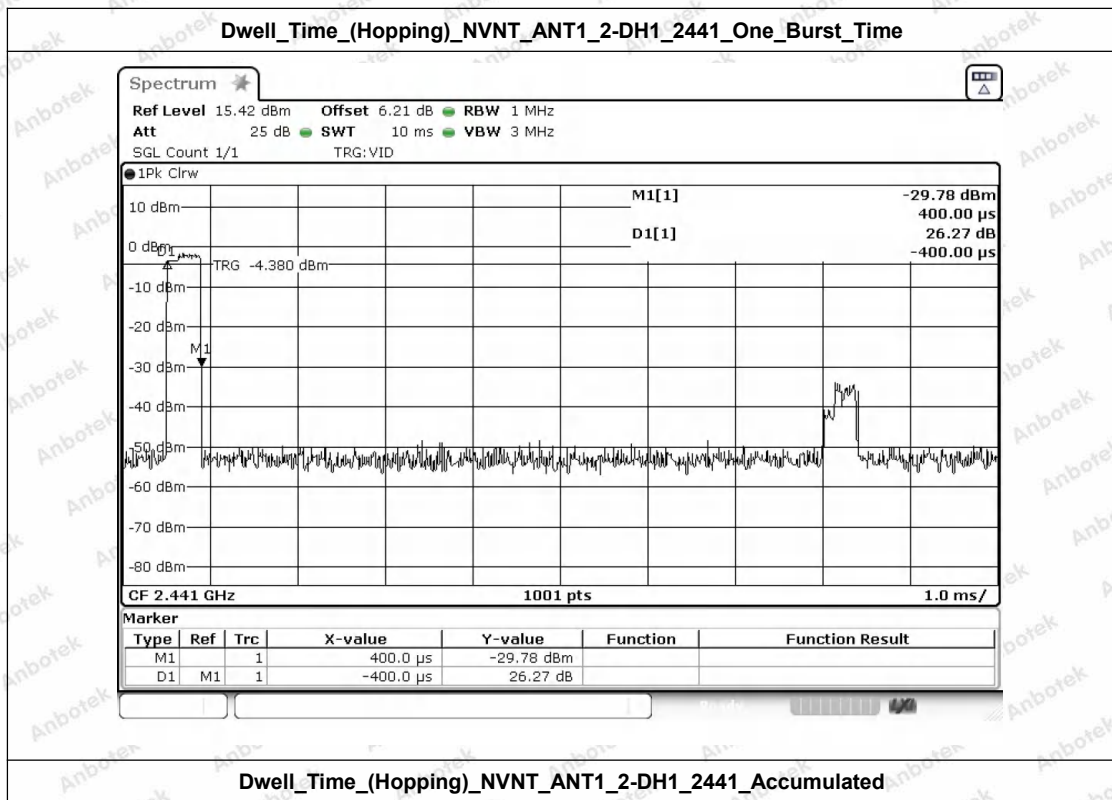
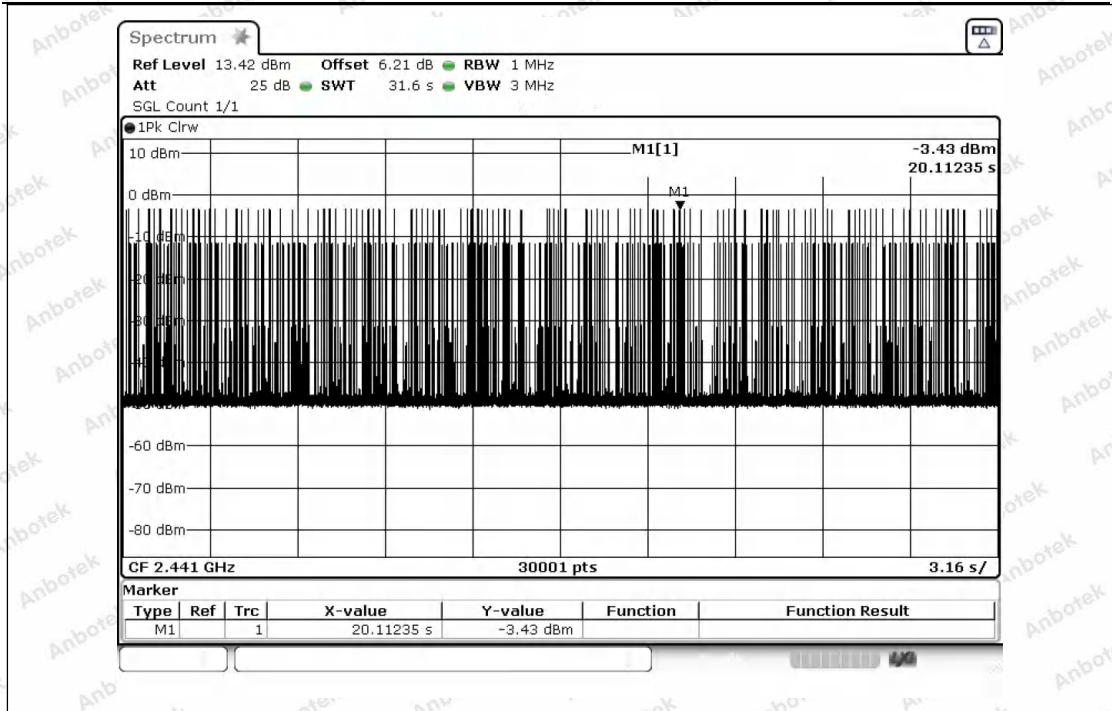

Shenzhen Anbotek Compliance Laboratory Limited

Address: 1/F., Building D, Sogood Science and Technology Park, Sanwei Community, Hangcheng Street, Bao'an District, Shenzhen, Guangdong, China.
 Tel: (86) 0755-26066440 Fax: (86) 0755-26014772 Email: service@anbotek.com

Hotline
 400-003-0500
 www.anbotek.com.cn



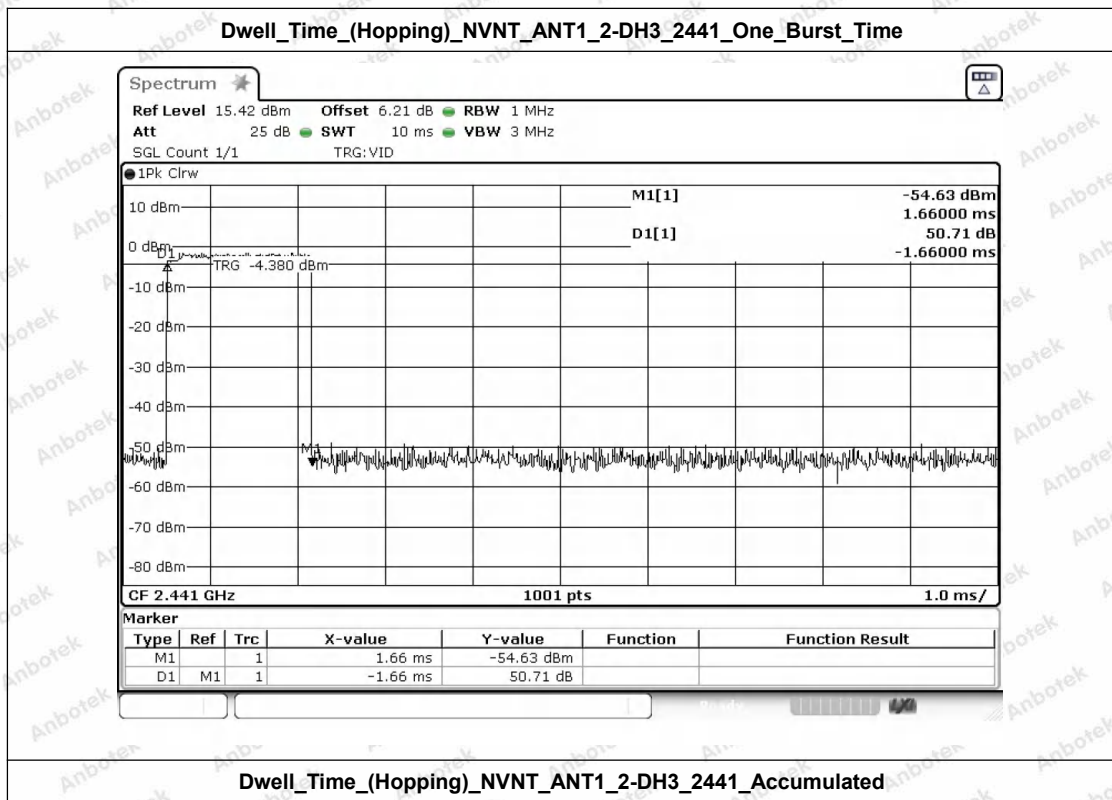
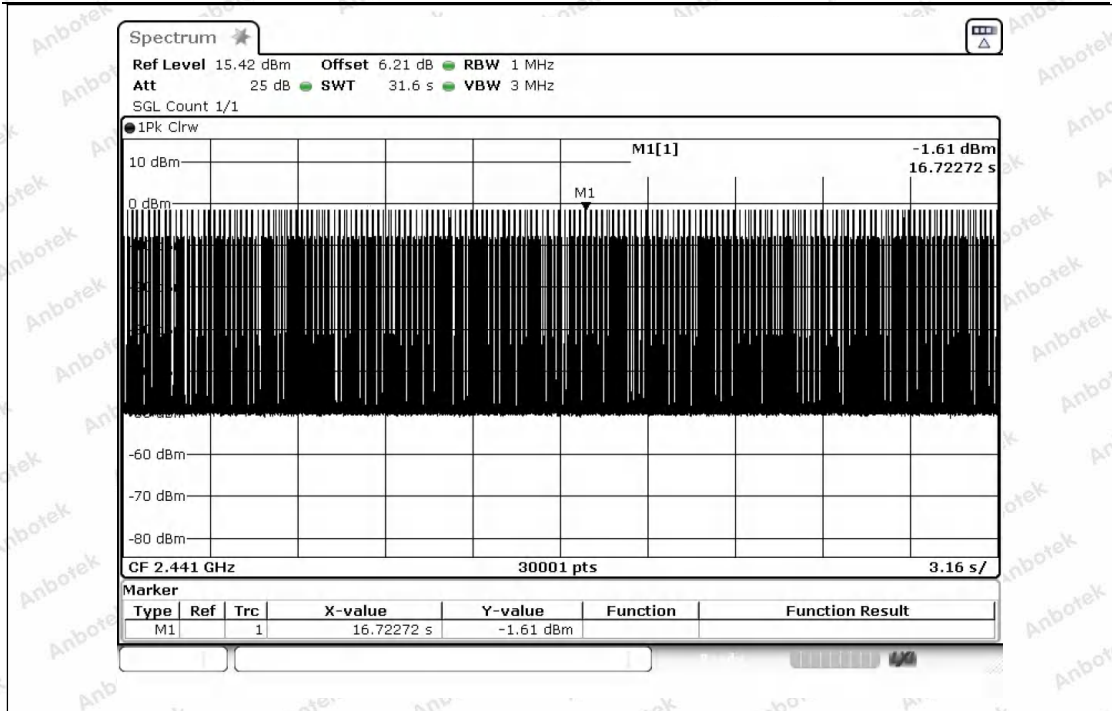

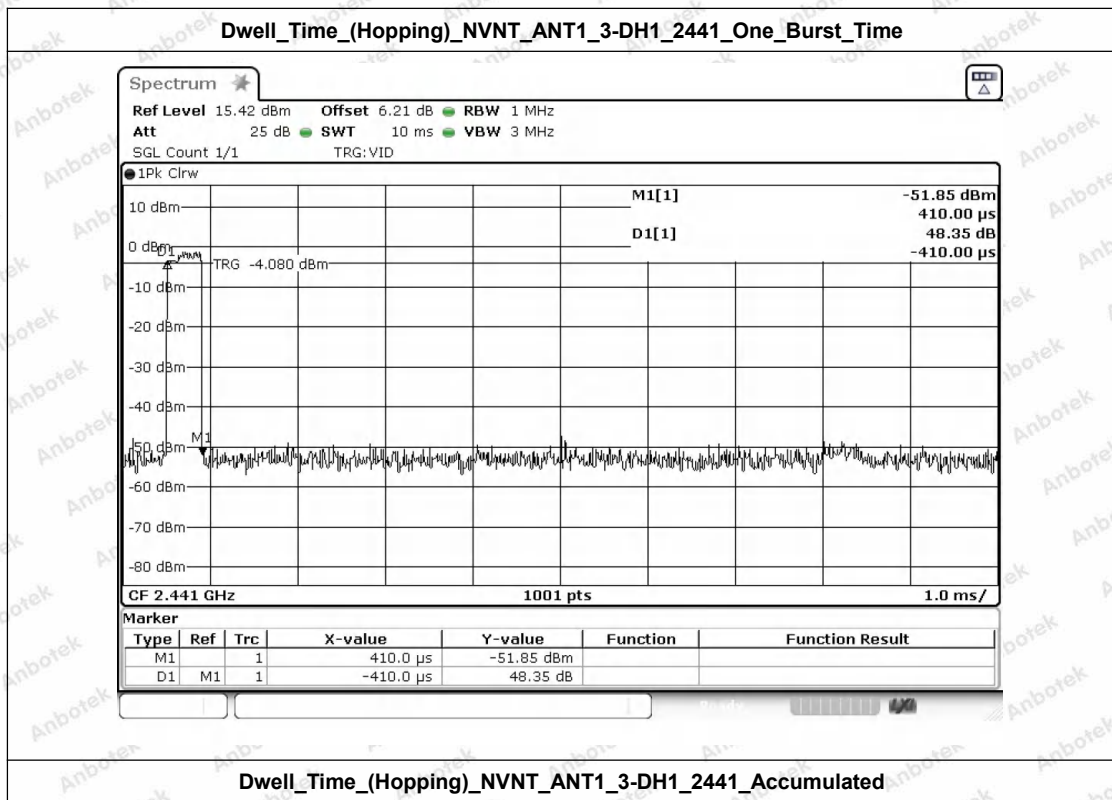
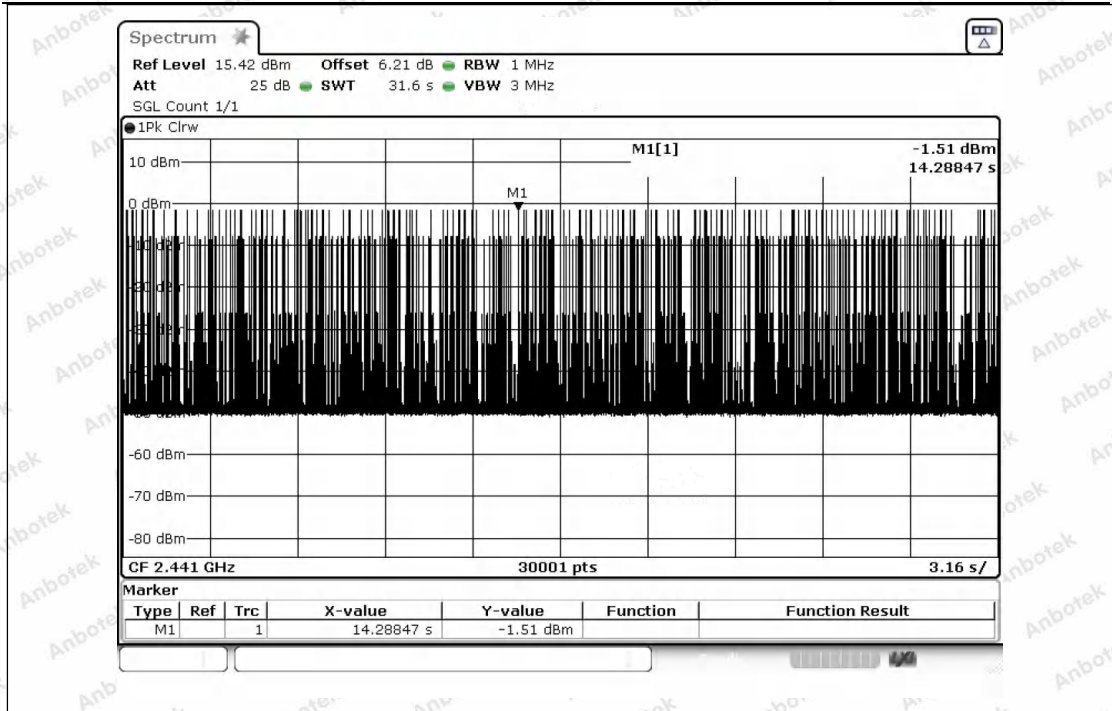

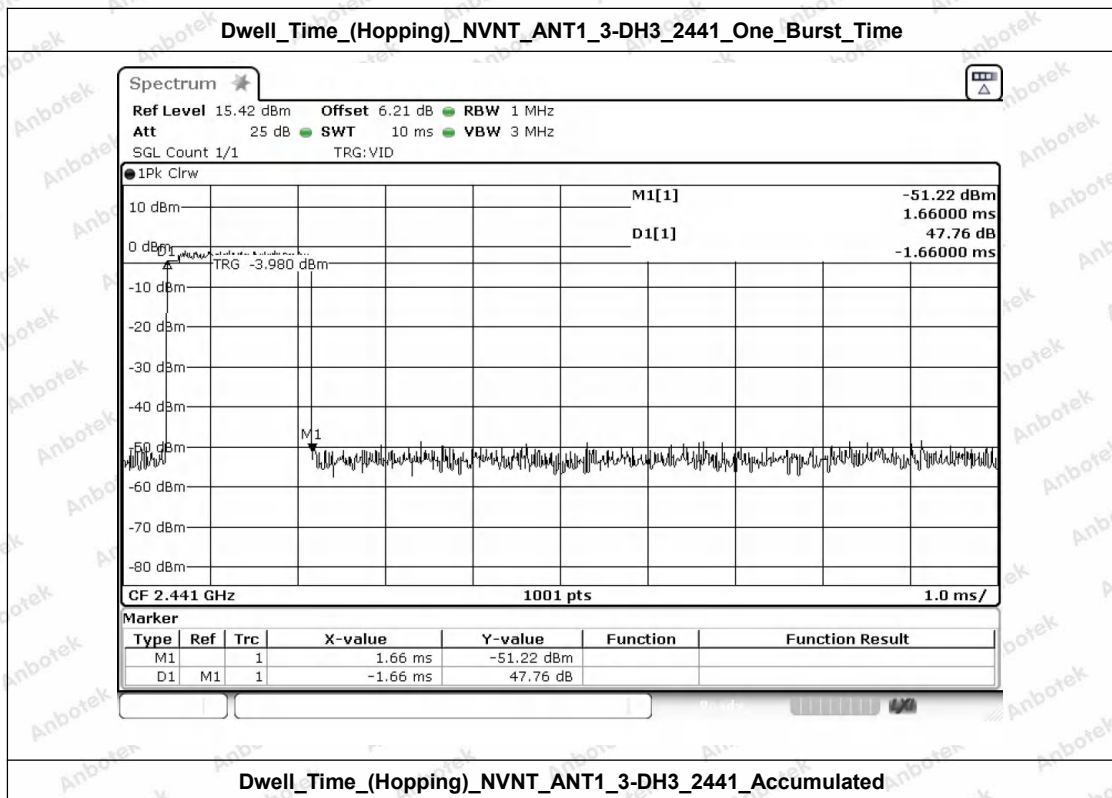
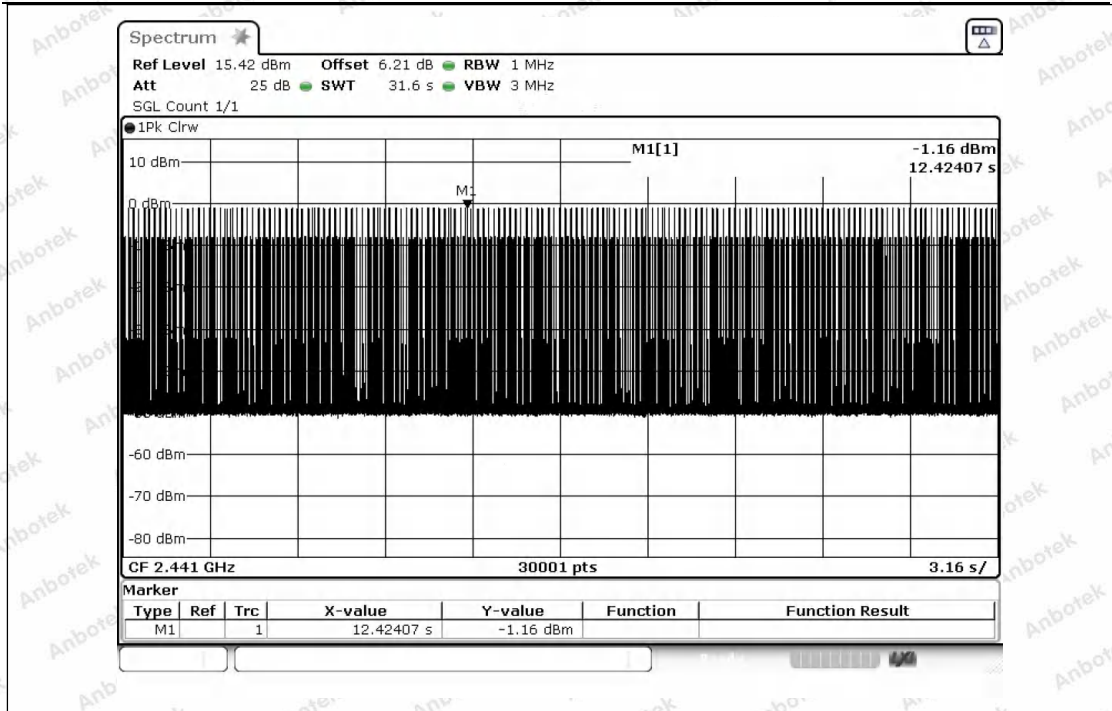

Shenzhen Anbotek Compliance Laboratory Limited

Address: 1/F., Building D, Sogood Science and Technology Park, Sanwei Community, Hangcheng Street, Bao'an District, Shenzhen, Guangdong, China.
 Tel: (86) 0755-26066440 Fax: (86) 0755-26014772 Email: service@anbotek.com

Hotline
 400-003-0500
 www.anbotek.com.cn



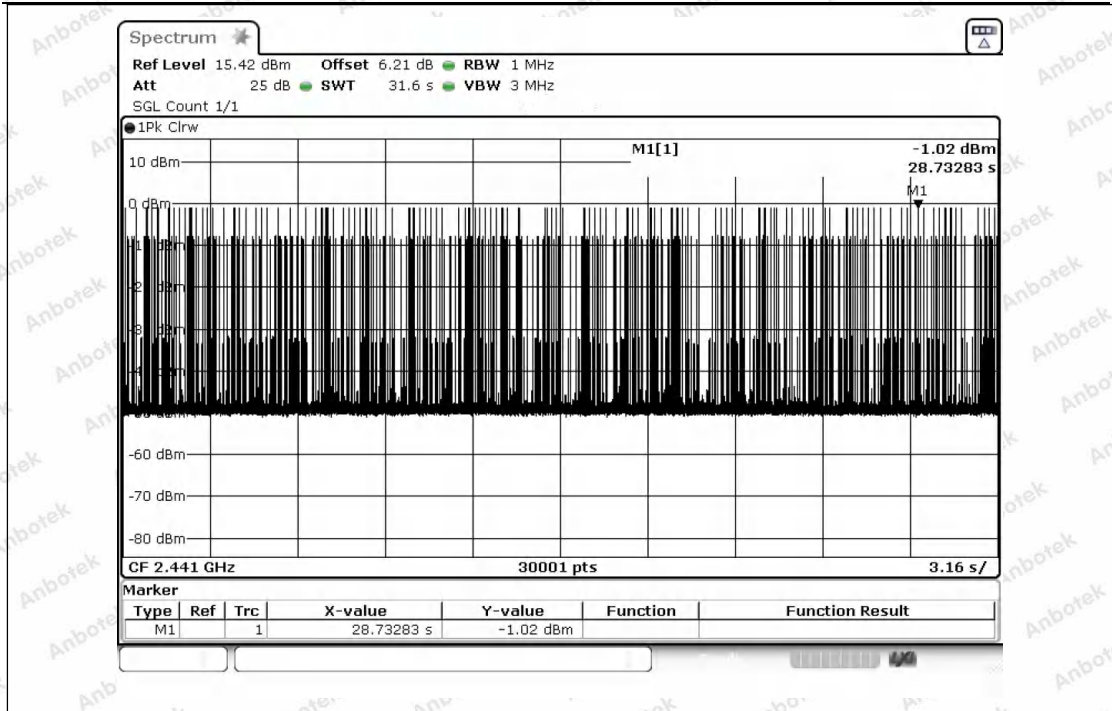

---End---

