

# DOG TRAINING COLLAR

**DeluPet**

Model  
**DT-70MB**

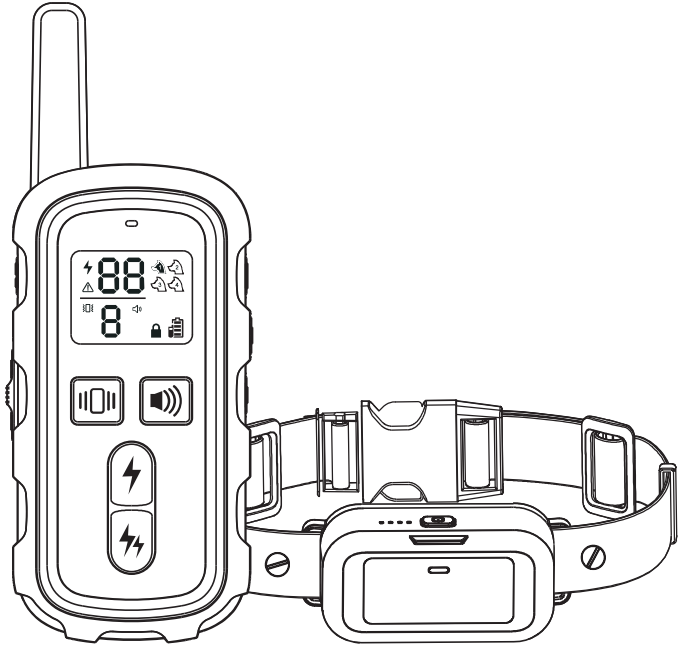

## User Manual

## Components



1 Handheld Remote

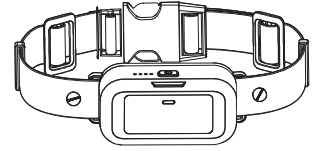

2 Receiver

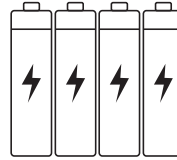

3 Battery

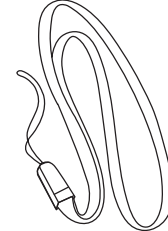

4 Neck Strap



5 User Manual



6 Test Light Tool

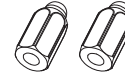

7 Long Contact Point



8 Conductive Silicone Cap

1

## Product Description

### Handheld Remote

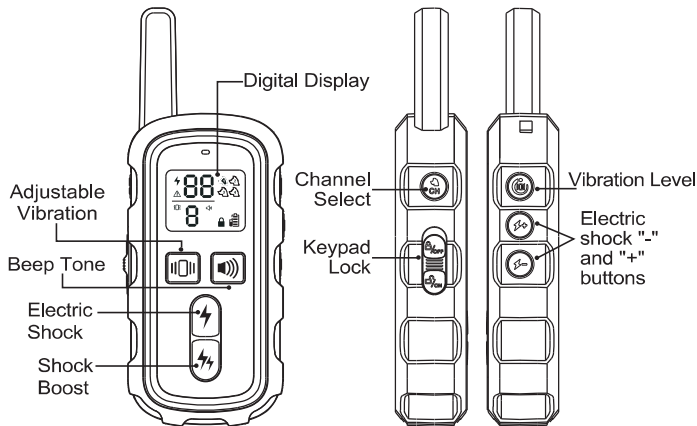

### Screen Content

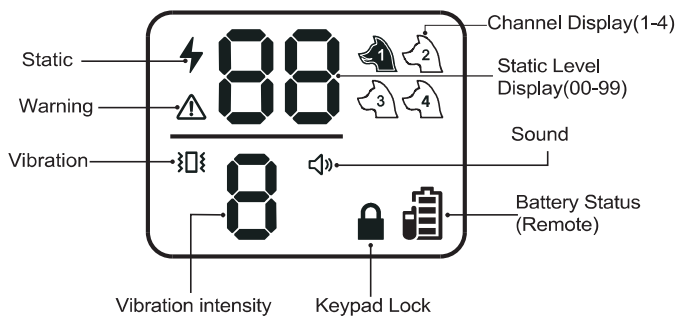

2

## Product Description

### Receiver

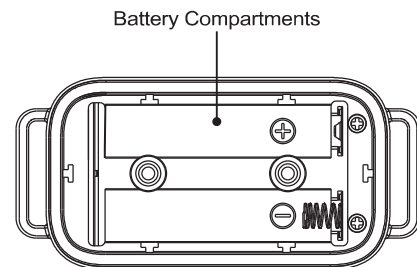
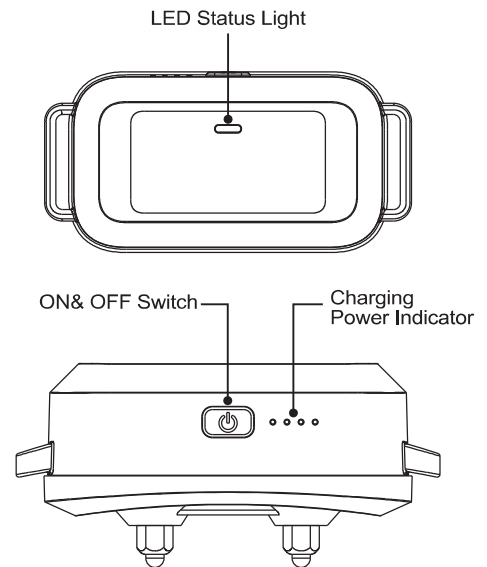

3

# Important Safety Information

## ⚠️ WARNING

Not for aggressive dogs. Do not use this Product if your dog is aggressive, or if your dog is prone to aggressive behavior. Aggressive dogs can cause severe injury and even death to their owner and others. If you are unsure whether this product is appropriate for your dog, please consult your veterinarian or certified trainer.

## ⚠️ CAUTION

Please read users manual carefully before using to avoid injury caused by improper use. Proper fit of the collar is important. A collar worn for too long or made too tight on the pet's neck may cause skin damage. Ranging from redness to pressure ulcers, which is commonly known as bed sores.

- Avoid leaving the receiver on the dog for more than 12 hours per day.
- When possible Reposition the receiver on your dog's neck every 1-2h.
- Check the fit to prevent excessive pressure; follow the instructions in this manual.
- Never connect a leash to the electronic collar; it will cause excessive pressure on the contacts.
- When using a separate collar for a leash, don't put pressure on the electronic collar.
- Wash the dog's neck area and the contacts of the collar weekly with a damp cloth.
- Check the contact area daily for signs of a rash or a sore.
- If a rash or sore is found, discontinue use of the collar until the skin has healed.

## ⚠️ CAUTION

- Safety during on-leash training. It is vitally important that you and your dog remain safe while learning during on-leash training. Your dog should be on a strong leash, long enough for him to attempt to chase an object, but short enough for him not to reach a road or other unsafe area. You must also be physically strong enough to restrain your dog when he tries to chase.
- This pet training device is not a toy, keep away from children.

4

## 3 Wearing Instructions:

**Note:** The Contact Points must have direct contact with Dog's skin on the underside of neck. Check the tightness of the Collar by inserting one finger snugly between the collar and neck.

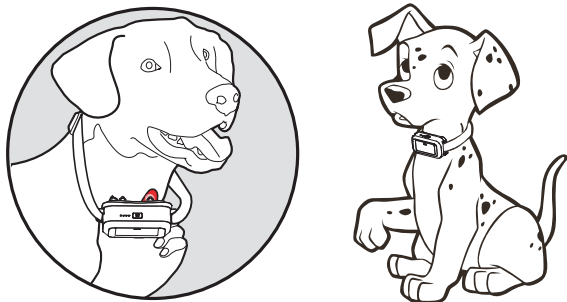

## 4 Switch description of transmitter and Receiver:

Turn ON the Receiver: Hold the ON button for 1 seconds.  
Turn OFF the Receiver: Hold the ON button for 3 seconds.

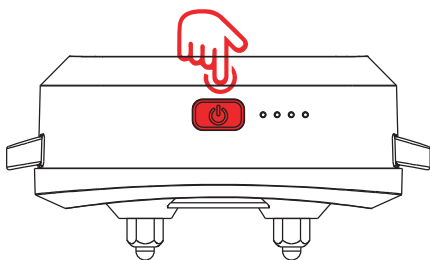

6

# Operating Guide

## 1 Handheld Remote :

Push down the slide cover to install the battery.

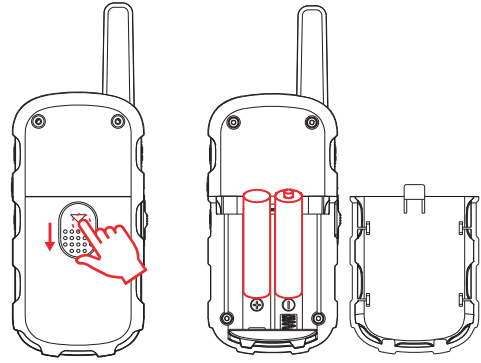

## 2 Receiver:

Unscrew the metal screw to remove the cover and install the battery.

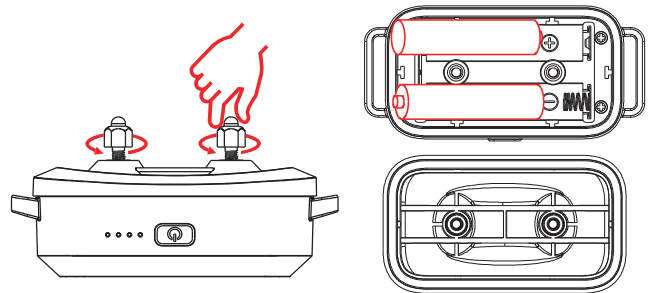

5

## 5 Switch lock description:

Security Keypad: Lock or unlock.

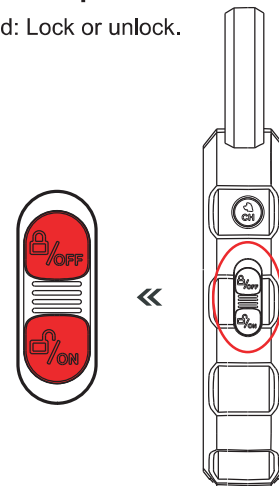

## 6 Explanation of voice commands:

Beep command: Delivers a beep tone with non-adjustable volume to the collar.

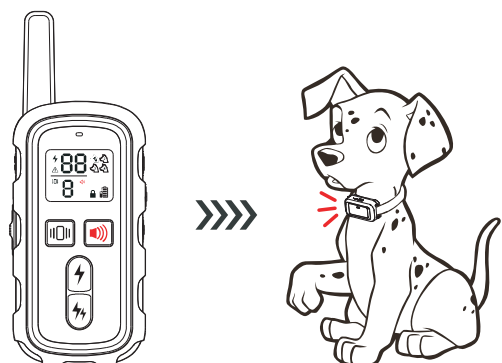

7

## 7 Description of the vibration command (How to adjust the level, level description):

Vibration command: Press the vibration key, the receiver vibrates once.

Intensity adjustment: After pressing the side vibration button, adjust the vibration level (1-9) by the side vibration button.

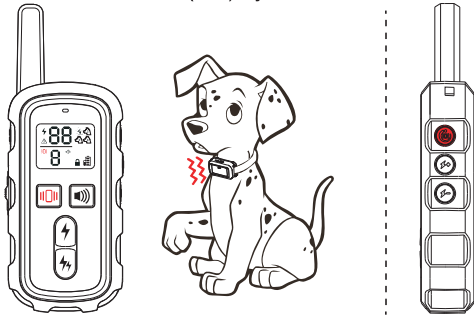

## 8 Instructions for the electric shock order (How to adjust the level, level instructions):

Static button: Delivers currently selected level Static stimulation to the collar. Static + button: That is 10% higher than the currently selected level. Static Intensity adjustment: After press the static button, adjust the static level level by "+" "-".

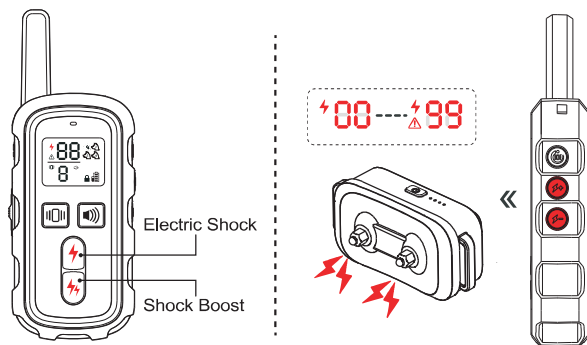

8





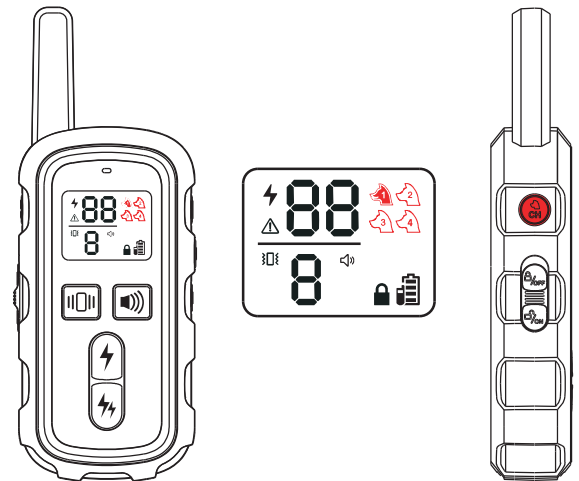

## 9 Channel switching instructions:

Channel switching: It is possible to train 4 dogs at the same time. Press the channel button briefly to select the dog to train.



9

## Main Features

-  3 Training Modes (Vibration, Tone and Shock ).
-  9-Speed vibration adjustable and 0-99 shock adjustable.
-  Receiver Collar IPX7 Waterproof, Remote IPX4 Waterproof.
-  Remote Range 1000-1600 Ft.
-  2-Hour Rapid Charging Lithium Polymer Battery.
-  Big Digital Display Shows Intensity Level, Battery and Dog.
-  Support 4 Receiver Collars with One Remote.

10

## Use of the Test Light Tool

### A : Electric shock test

1. Make sure the Remote and Receiver Collar on.
2. Hold the Test Light tool contacts to the Contact Points.
3. Press a Static button on the Remote Transmitter. The Test Light will be lighted.

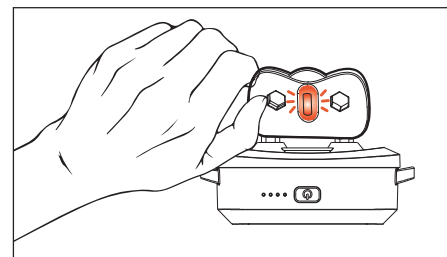

### B: As a tool to tighten or loosen the contact points

For dog with shorter coats, use 2pcs shorter contact points. For dog with thicker coats, use 2pcs longer contact points. Install the conductive Silicone onto the contact point to make it softer. It may better to your dog's skin.

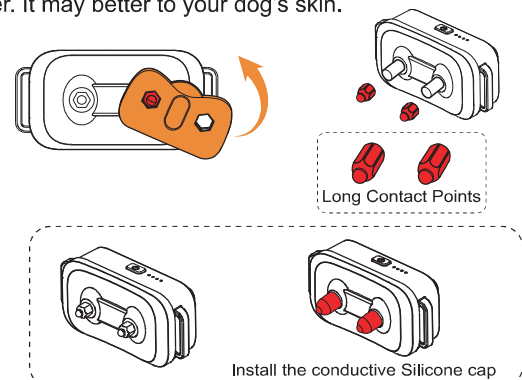

11

## Training Tips

1. Reward your dog with food / treats will usually help to achieve the best training result.
2. Do not use the device on dogs aged below 6-month, old, pregnant, easily frightened, aggressive, in heat, and in inferior health conditions.
3. Use verbal commands first, and supplement with a corrective stimulus only as needed. Be consistent with your verbal commands, use the same words every time. Work with your pet on one behavior at a time to avoid confusion and frustration.
4. Use as little stimulus as possible and only to reinforce verbal commands when necessary. Do not over correct your dog.
5. For example, use the beep sound as warning by pressing the beep button. The dog will become conditioned to the beep preceding the corrective stimulus and will soon learn to recognize the beep as a warning along with your verbal command.
6. Do not rely on this product solely to train your dog. Some dogs will not respond to this product. We cannot guarantee the effectiveness of this or any trainer on your dog. If your dog shows signs of growling, biting or aggression while using the collar, discontinue use immediately and contact a professional trainer for advice.
7. It is recommended to train one dog at a time in a distraction-free environment, both to increase efficiency and to avoid temptation or distraction from other dogs.

12

## Pairing Instructions

(Note: You can skip this step as the device is factory-paired.)

### Match the remote to the receiver:

1. Make sure the receiver is turned off.
2. Press and hold the receiver switch for 5 seconds until the green light flashes quickly.
3. Press the remote control pairing button to pair the receiver.
4. Pairing is successful: the receiver will beep and the green light will flash.

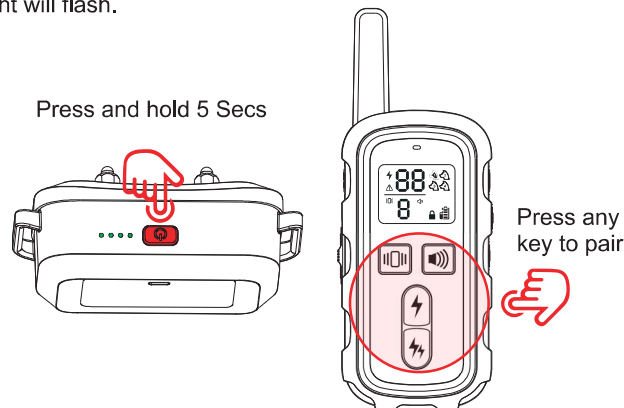

(Note: If you are only using one receiver, skip this step. The following settings apply to multiple receivers with one remote.)

Part I: Pairing a 2nd, 3rd or 4th Receiver.

### Pairing multiple receivers:

1. Make sure the receiver is turned off.
2. Press and hold the receiver switch for 5 seconds until the green light flashes quickly.
3. Press the channel key, select the channel in advance, and select the number you want.
4. Pairing is successful: the receiver will beep and the green light will flash.

13

## Question & Answer

**How to change the longer prongs for this collar? I don't think they are getting through my Labs thick hair.**

**Answer:** Just part the hair or trim it a bit. I have a dog with very thick neck of hair. I parted it with my hands. Just be sure remote is off then start on low setting and work your way up. If no response repeat steps of working prongs thru hair remember to turn off or lock remote.

**Is the Vibration/ Shock safe for my pet?**

**Answer:** While the Vibration/Shock is unpleasant, it is harmless to your pet. Electronic training devices require interaction and training from the owner to achieve desired results.

## Troubleshooting

**1. My pet is not responding when I press a beep vibration or static button.**

- Check the Receiver Collar if it is On.

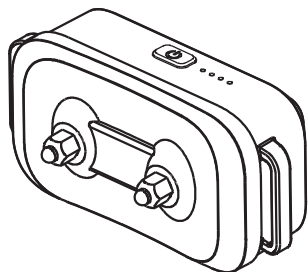

14

- Please check if the battery is low in either the Remote Transmitter or Receiver Collar.

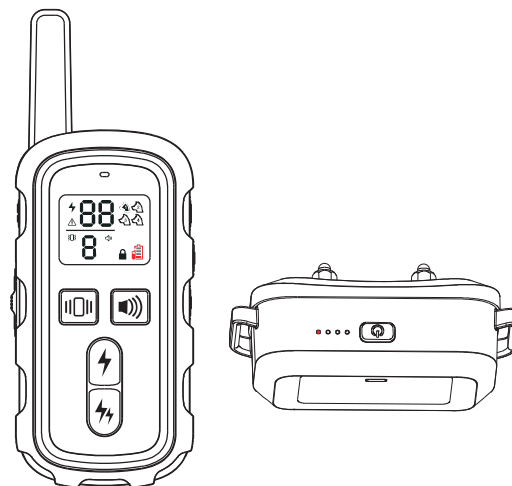

- Test the Receiver with the Test Light to confirm if shock functions normally.

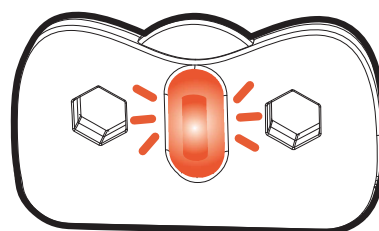

- Increase the correction level. Refer to "Find the Best Stimulation Level For Your dog".

15

- Make sure the Receiver Collar's Contact Points are placed snugly against your pet's skin.

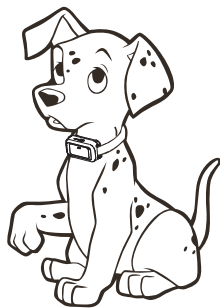

**2. Fail to match receiver with remote. Ensure the receiver is connected to a power source (charging mode can only be activated while charging). Must hold the channel switch for more than 5 seconds, if not, matching will fail. If the problem persists after attempting as above, please contact us to confirm whether the receiver and the remote are of the same version.**

Press and hold 5 Secs

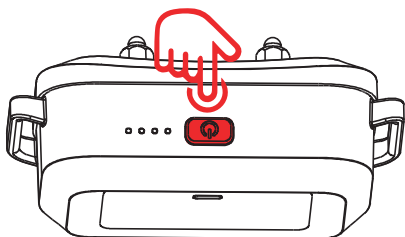

16

## Operating Environment & Maintenance

### Do not use the product in the circumstances as follow:

1. Do not operate the devices under temperature of 104°F and above, doing so in such high temperature will decrease the performance of the batteries.
2. Do not use the set in places with strong electromagnetic interference. This will greatly compromise the performance of the product.
3. Avoid dropping the devices on hard surface or inflict excessive force on them.
4. Avoid using the devices in environment flooded with corrosive chemical, this may lead to color degrading, deforming, or cracking of exterior of the devices.

### Maintenance:

1. When not in use, please wipe clean both the Remote and Receiver with mild detergent. Turn off the Remote, lock the keypad, put on the rubber lid on the Receiver's charging port, and store the set in a cool dry place.
2. During cleaning, wipe with soft cloth and mild detergent. Do not use hard brushes which may scratch the surface of the device.
3. If the Receiver has gotten dirty, wipe it clean with a damp cloth.

**Note: Do not submerge the Receiver into water for long period of time, even though it is waterproof.**

4. If found residues around the charging port's rubber lid, you should wipe it clean to prevent water from sipping in.
5. If the Remote fell into water, pick it up quickly and turn off the power. Dry it with cloth as much as you can and let it out to dry. It should resume function normally once the moisture is dried out.

18

### 3. Remote/receiver does not response.

- Verify if the Receiver Collar is on.

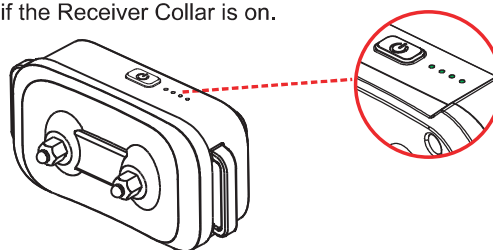

- Verify if the battery of the Transmitter is fully charged.

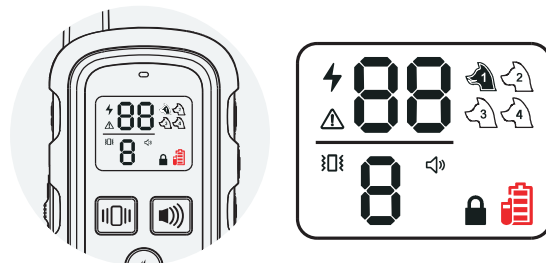

- Verify if the training collar has been paired.

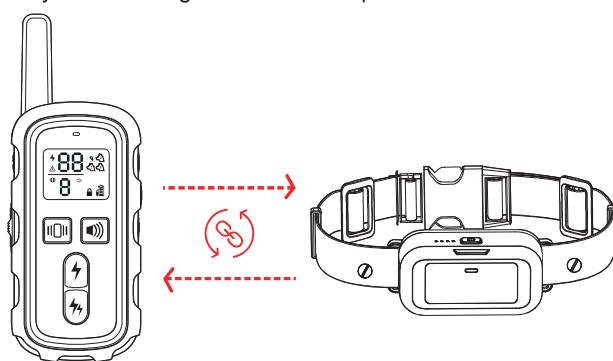

17

## Regarding you and the product

1. It is strictly prohibited to open the receiver in any situation. Doing so will likely compromise the waterproof function and thus voiding the product warranty.
2. Please use the remote control and the receiver from the complete set. Do not use other product to match with the receiver.
3. If you want to test the product, please use professional testing apparatus. Do not test with hands, so as to avoid accidental injury.
4. If find water at the charging port, please wipe it dry before charging.
5. Beware of the interference from the environment, it can cause the product not to work properly. For examples, places with high voltage facilities, communication towers, thunderstorm, large buildings, and strong electromagnetic interference.
6. Receiver will be turned off if idling for 8 hours.
7. The included collar is a basic accessory and is not necessarily suitable for all types of dog breeds. Any collar not wider than 24mm and not thicker than 5mm, made of soft material, can be a replacement for the current collar.

## Regarding well-being of your dog

1. The Receiver collar is not a regular collar and not recommended to put on a leash to walk your dog. (Doing so during pulling may hurt the dog due to protruding electrodes on the Receiver.)
2. Do not put the collar on for over 12 hours, it may cause rashes or discomfort to your dog's skin.
3. Do not allow children, or anyone who has little or no experience with training dogs, to handle this training kit.
4. In order to guarantee normal diving function, please insert the waterproof rubber lid over the charging port.
5. Static stimulation is not a pleasant experience for any dogs. Punishment is harsh way to train a dog. Always, the praise could encourage your dog for good behavior.

19

## Terms of Use & Limitation of Liability

1. Use of this product means you accept all the terms and conditions.
2. This product is a professional dog training device. You are not recommended to use this product if your dog is clever and less than 15 lbs in weight. If you're not sure whether the product is suitable for your pet dog, please consult a professional handler or contact us.
3. This product is a professional dog training device and should not be used for other purposes. Please do not violate local laws in using this product.
4. We bear no liability for any direct or indirect losses caused by use or misuse of this product; all risks in using this product shall be borne by user.
5. Please contact the dealer for parts warranty, goods return or exchange. We provide only technical support.
6. We reserve the right to alter the terms, conditions and notices of this product offered.

## Reference Weight for Dogs

Large Dog (Body height above 24 inches, Weight above 88 lbs)  
Medium Dog (Height 16-24 inches, Weight 24.2-66 lbs)  
Small Dog (Height 10-16 inches, Weight 8.8-22 lbs)  
Mini Dog (Height under 10 inches, Weight under 8.8 lbs)

20

## Product Specification

Model	DT-70
Receiver's Casing	IPX7 waterproof
Remote's Casing	IPX4 waterproof
Remote/Receiver Standby Time	Remote 45 days Receiver 35 days
Remote to Receiver's Signal Range Distance	1600FT
Maximum supported quantity	4 receivers

22

## FCC Statement

**This device complies with part 15 of the FCC Rules.**

**Operation is subject to the following two conditions:**

- (1) This device may not cause harmful interference.
- (2) This device must accept any interference received, including interference that may cause undesired operation.

Warning: Changes or modifications not expressly approved, by the party responsible for compliance could void the user's authority to operate the equipment.

**NOTE:** This equipment has been tested and found to comply with the limits for a Class B digital device, pursuant to part 15 of the FCC Rules. These limits are designed to provide reasonable protection against harmful interference in a residential installation. This equipment generates, uses, and can radiate radio frequency energy and, if not installed and used in accordance with the instructions, may cause harmful interference to radio communications. However, there is no guarantee that interference will not occur in a specific installation. If interference does occur to radio or television reception, which can be determined by turning the equipment off and on, the user is encouraged to try to correct the interference by one or more of the following measures:

- Increase the separation between the equipment and the receiver.
- Connect the equipment to an outlet on a circuit different from that to which the receiver is connected.
- Consult customer care, the dealer, or an experienced radio/TV technician for help.

21

## Reference Size for Different Dogs

Size	Neck(in)	Chest Measurement(in)	Back Length(in)
Mini	7.8-8.6	9.8-11.8	7.5
Small	7.8-9.5	11.4-14.2	9
Medium	9-11	13.7-16.5	11
Large	10.6-12.2	16.2-18.5	12.2
Large	11.8-13.4	18.1-20.8	13.8
Large	13-14.5	20.5-23.2	15.7
Huge	17-18.9	30-33	23.6
	18.5-20.5	34.6-38.2	25.6
	21.6-24.4	36.2-39.3	27.5

23

# Warranty and repair information

## 1-Year Warranty

The original purchaser for this unit is provided with 1-YEAR WARRANTY.

The warranty begins from the date of purchase. For the first year, coverage is for both Parts and Labor on warranty repair services, but the return postage is for the buyer's account.

Accessories such as chargers, straps, and batteries are covered for the first year only. When the warranty expires, customers will need parts and repairs at their own expense.

## Won't Qualify for 1-Year Warranty

- We do not offer warranty for products that have been bought secondhand or as a resold product.
- Manual damage or loss is not covered by the warranty.
- Any water damage on the Water Resistant Transmitters and the Water Resistant Receivers of our product series will not be covered.
- The warranty is void if the unit has been altered or an unauthorized person who attempts to repair work has damaged the unit.
- Replacement of batteries is not recommended during the warranty period. If the customer chooses to replace the batteries, any damage to the unit during the change-out by the owner will make the warranty void.

## To activate the warranty

If there is problem with your product, please send the below info to [service@delupet.com](mailto:service@delupet.com) for after-sale service.

1. Your original order page.
2. Your current shipping address After confirm the info, we will send you the replacement within 5 business days.
3. After confirm the info, we will send you the replacement within 5 business days.