

# Test Report

**Product:** Apple Watch USB-C Charging Cable  
3.3ft

**Trade Mark:** ventev

**Model Number:** AW3-WHT264607

**FCC ID:** 2A3XF-AW3

**Prepared for**

Voice Comm, LLC

80 Twinbridge Dr, Pennsauken Township, NJ 08110

**Prepared by**

Shenzhen HongBiao Certification& Testing Co., Ltd

Room 102, 201, Building 2, Yuanwanggu RFID Industrial Park, Tongguan  
Road, Tianliao Community, Yutang Street, Guangming District, Shenzhen,  
China

Tel.: +86-755-2998 9321 Fax.: +86-755-2998 5110

Website: <http://www.sz-hongbiao.com>

## Table of Contents

<b>1</b>	<b>GENERAL DESCRIPTION .....</b>	<b>5</b>
1.1	DESCRIPTION OF EUT .....	5
1.2	TEST MODE.....	5
1.3	TEST SETUP .....	6
1.4	ANCILLARY EQUIPMENT .....	6
<b>2</b>	<b>SUMMARY OF TEST RESULT .....</b>	<b>7</b>
<b>3</b>	<b>TEST FACILITIES AND ACCREDITATIONS .....</b>	<b>8</b>
3.1	TEST LABORATORY .....	8
3.2	ENVIRONMENTAL CONDITIONS .....	8
3.3	MEASUREMENT UNCERTAINTY .....	8
3.4	TEST SOFTWARE .....	8
<b>4</b>	<b>LIST OF TEST EQUIPMENT .....</b>	<b>9</b>
<b>5</b>	<b>TEST ITEM AND RESULTS .....</b>	<b>11</b>
5.1	ANTENNA REQUIREMENT .....	11
5.2	CONDUCTED EMISSION .....	12
5.3	RADIATED EMISSION .....	16
5.4	OCCUPIED BANDWIDTH .....	21
<b>6</b>	<b>PHOTOGRAPHS OF THE TEST SETUP.....</b>	<b>23</b>
<b>7</b>	<b>PHOTOGRAPHS OF THE EUT .....</b>	<b>25</b>

**TEST RESULT CERTIFICATION**

**Applicant’s Name**..... : Voice Comm, LLC  
Address ..... : 80 Twinbridge Dr, Pennsauken Township, NJ 08110  
**Manufacturer's Name** ..... : Ventev Mobility  
Address ..... : 175 Deroousse Ave, Suite 100 Pennsauken, NJ 08110

**Product description**

Product name ..... : Apple Watch USB-C Charging Cable 3.3ft  
Model Number ..... : AW3-WHT264607

**Standards** ..... : FCC Part 15C  
Test procedure..... : ANSI C63.10: 2014

This device described above has been tested by Shenzhen HongBiao Certification& Testing Co., Ltd and the test results show that the equipment under test (EUT) is in compliance with the EMC requirements. And it is applicable only to the tested sample identified in the report.

**Date of Test** .....:  
Date (s) of performance of tests .....: Sept. 12, 2023~ Sept. 20, 2023  
Test Result.....: **Pass**

**Testing Engineer** :   
( Z o e S u )

**Technical Manager** :   
( G a r y L u )

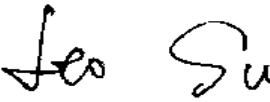
**Authorized Signatory** :   
( L e o S u )

**Revision History**

Revised No.	Date of Issue	Description
01	Sept. 20, 2023	Original

# 1 General Description

## 1.1 Description of EUT

Product name:	Apple Watch USB-C Charging Cable 3.3ft
Model name:	AW3-WHT264607
Series Model:	AW3-BK-WHT264607
Different of series model:	All the models are the same circuit and module, except the model name, packaged and logo.
Operation frequency:	Watch: 326.5kHz, 1778kHz
Operational mode:	Wireless charging
Modulation type:	ASK
Antenna type:	Coil Antenna
Hardware version:	V1.0
Software version:	V1.0
Power supply:	Input: DC 5V/1A Output: DC 5V/1A MAX Wireless Output: 3W, 5W
Adapter information:	N/A

## 1.2 Test Mode

Pretest Test Mode	Description of Mode
1	Wireless Output: 3W
2	Wireless Output: 5W

Test Item	Final Test Mode
Conducted Emissions	1
Radiated Emissions	1
20dB bandwidth	1

### 1.3 Test Setup

See photographs of the test setup in the report for the actual setup and connections between EUT and support equipment.

### 1.4 Ancillary Equipment

Equipment	Model	S/N	Manufacturer
Watch	MNP53CH/A	FKY0FHQ9N 3	Apple Inc.
Adapter	TA65B	2S36003438 PL97T09582	Lenovo
/	/	/	/

## 2 Summary of Test Result

Test procedures according to the technical standards:

FCC Part 15C				
No.	Standard Section	Test Item	Result	Remark
1	FCC Part 15.203	Antenna Requirement	Pass	
2	FCC Part 15.207	Conducted Emission	Pass	
3	FCC Part 15.209	Radiated Emission	Pass	
4	FCC Part 15.215	20dB Bandwidth	Pass	

Note:  
1. "N/A" means the test case does not apply to the test object.

### 3 Test Facilities and Accreditations

#### 3.1 Test Laboratory

Test Site	Shenzhen HongBiao Certification& Testing Co., Ltd
Test Site Location	Room 102, 201, Building 2, Yuanwanggu RFID Industrial Park, Tongguan Road, Tianliao Community, Yutang Street, Guangming District, Shenzhen, China
Telephone:	(86-755) 2998 9321
Fax:	(86-755) 2998 5110
FCC Registration No.:	CN1341
A2LA Certificate No.:	6765.01

#### 3.2 Environmental Conditions

During the measurement the environmental conditions were within the listed ranges:

Temperature:	15°C~35°C
Relative Humidity:	20%~75%
Air Pressure:	98kPa~101kPa

#### 3.3 Measurement Uncertainty

The reported uncertainty of measurement  $y \pm U$ , where expanded uncertainty  $U$  is based on a standard uncertainty multiplied by a coverage factor of  $k=2$ , providing a level of confidence of approximately 95 %.

Measurement Frequency Range	U, (dB)	Note
RF frequency	$2 \times 10^{-5}$	
RF power, conducted	$\pm 0.57$ dB	
Conducted emission(150kHz~30MHz)	$\pm 2.5$ dB	
Radiated emission(30MHz~1GHz)	$\pm 4.2$ dB	
Radiated emission (above 1GHz)	$\pm 4.7$ dB	
Occupied bandwidth	$\pm 3$ %	
Temperature	$\pm 1$ degree	
Humidity	$\pm 5$ %	

#### 3.4 Test Software

Software name	Manufacturer	Model	Version
EMI Measurement	Farad	EZ-EMC	V1.1.4.2
Conducted test system	MWRF-test	MTS 8310	V2.0.0



## 4 List of Test Equipment

Radiation emission							
Item	Equipment No.	Equipment name	Manufacturer	Model	Serial No.	Calibration date	Due date
1	HB-E001	Horn Antenna	Schwarzbeck	BBHA 9120D	02592	2022-04-02	2024-04-01
2	HB-E002	Biconical log-periodic composite antenna	Schwarzbeck	VULB 9168	01340	2022-04-06	2024-04-05
3	HB-E003	SHF-EHF Horn	Schwarzbeck	BBHA 91270	01193	2022-04-02	2024-04-01
4	HB-E004	Preamplifier	Noyetec	LAN-0910	NYCM1420101	2023-05-11	2024-05-10
5	HB-E005	Preamplifier	Noyetec	LAN-0118	NYCM1420102	2023-05-12	2024-05-11
6	HB-E006	Preamplifier	Noyetec	LAN-1840	NYCM1420103	2023-06-11	2024-06-10
7	HB-E007	EMI TEST RECEIVER	R&S	ESR7	102520	2023-05-12	2024-05-11
8	HB-E009	POSITINAL COTROLLE R	Noyetec	N/A	N/A	/	/
9	HB-E013	RF switch	Noyetec	NY-RF4	NY0CM1420204	/	/
10	HB-E066	Illuminance Tester	TASI	TA8121	N/A	2023-05-11	2024-05-10
11	HB-E075	Active loop antenna	Schwarzbeck	FMZB 1519B	1519B-245	2022-07-24	2024-07-23
Conduction emission							
Item	Equipment No.	Equipment name	Manufacturer	Model	Serial No.	Calibration date	Due date
1	HB-E014	4 Path V-LISN	Schwarzbeck	NNLK 8121	00770	2023-05-12	2024-05-11
2	HB-E015	Pulse Limiter	Schwarzbeck	VTSD 9561-F	00949	2023-05-12	2024-05-11
3	HB-E016	ZN23201	Noyetec	ZN23201	N/A	2023-05-11	2024-05-10
4	HB-E059	Attenuator	Xianghua	TS2-6-1	220215166	2023-05-12	2024-05-11
5	HB-E069	EMI TEST RECEIVER	R&S	ESCI	N/A	2023-05-12	2024-05-11
RF							
Item	Equipment No.	Equipment name	Manufacturer	Model	Serial No.	Calibration date	Due date
1	HB-E041	MXG Anaioq Signal Generator	Agilent	N5181A	MY47070421	2023-05-11	2024-05-10
2	HB-E042	WIDEBAND RADIO COMMUNICA	R&S	CMW500	132108	2023-05-11	2024-05-10

		TION TESTER					
3	HB-E043	MXG Anaioq Signal Generator	Agilent	N5182A	US46240335	2023-05-11	2024-05-10
4	HB-E044	Signal& spectrum Analyzer	R&S	FSV3044	101264	2023-05-11	2024-05-10
5	HB-E045	RF Control Box	Noyetec	NY100-R FCB	N/A	/	/
6	HB-E058	Thermometer Clock Humidity Monitor	N/A	HTC-1	N/A	/	/

Note: the calibration interval of the above test instruments is 12&24 months and the calibrations are traceable to international system unit (SI).

## **5 Test Item And Results**

### **5.1 Antenna Requirement**

#### **5.1.1 Standard Requirement**

15.203 requirement: For intentional device, according to 15.203: an intentional radiator shall be designed to ensure that no antenna other than that furnished by the responsible party shall be used with the device

#### **5.1.2 Test Result**

The EUT antenna is Coil Antenna. It comply with the standard requirement. In case of replacement of broken antenna the same antenna type must be used.

## 5.2 Conducted Emission

### 5.2.1 Limits

Limits – Class A		
Frequency (MHz)	Limit (dB $\mu$ V)	
	Quasi-Peak	Average
0.15 to 0.5	79	66
0.5 to 30	73	60
Limits – Class B		
Frequency (MHz)	Limit (dB $\mu$ V)	
	Quasi-Peak	Average
0.15 to 0.5	66 to 56*	56 to 46*
0.5 to 5	56	46
5 to 30	60	50
Note: 1. the tighter limit applies at the band edges. 2. the limit of " * " marked band means the limitation decreases linearly with the logarithm of the frequency in the range.		

### 5.2.2 Test Procedures

- a) The EUT was placed 0.8 meters from the horizontal ground plane with EUT being connected to the power mains through a line impedance stabilization network (LISN). All other support equipment powered from additional LISN(s). The LISN provide 50 Ohm/ 50uH of coupling impedance for the measuring instrument.
- b) Interconnecting cables that hang closer than 40 cm to the ground plane shall be folded back and forth in the center forming a bundle 30 to 40 cm long.
- c) I/O cables that are not connected to a peripheral shall be bundled in the center. The end of the cable may be terminated, if required, using the correct terminating impedance. The overall length shall not exceed 1 m.
- d) LISN is at least 80 cm from nearest part of EUT chassis.
- e) For the actual test configuration, please refer to the related Item – photographs of the test setup.

### 5.2.3 Test setup

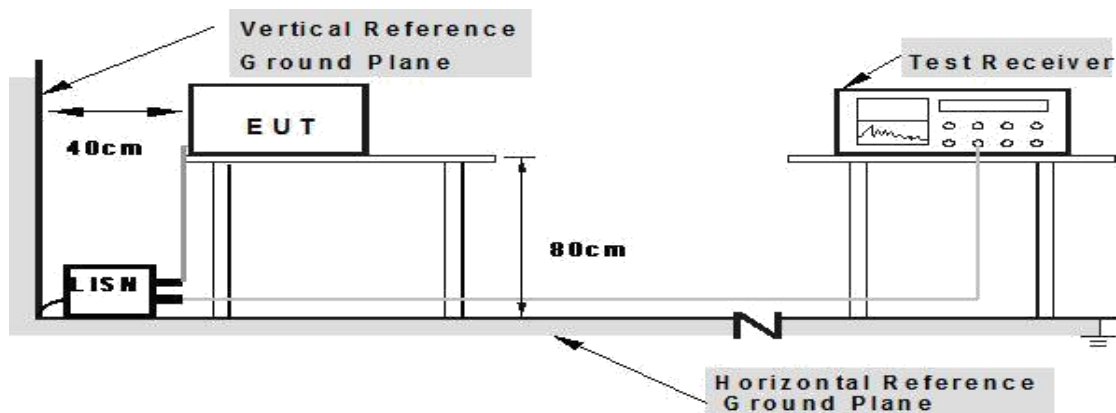

### 5.2.4 Test Result

EUT:	Apple Watch USB-C Charging Cable 3.3ft	Model Name:	AW3-WHT264607
Test Mode:	Mode 1	Phase:	L
Test Voltage:	DC 5V from adapter AC 120V/60Hz		

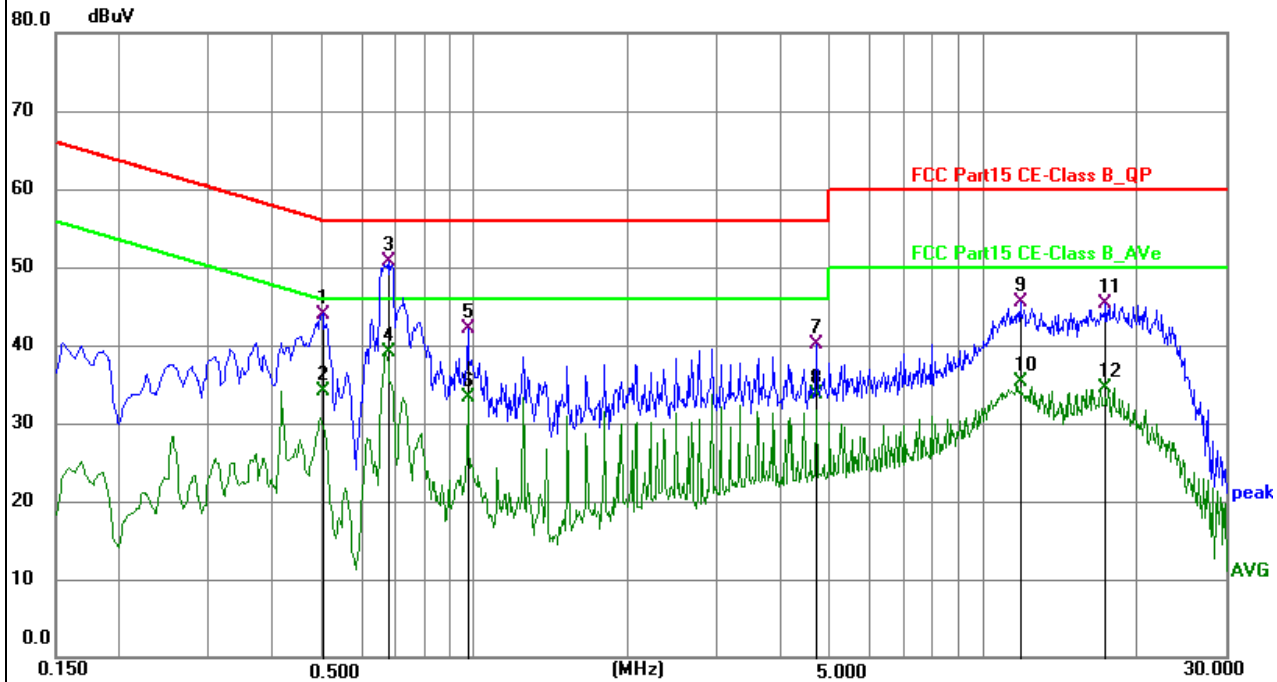

No.	Frequency (MHz)	Reading (dBuV)	Factor (dB)	Level (dBuV)	Limit (dBuV)	Margin (dB)	Detector
1	0.501000	33.92	10.08	44.00	56.00	-12.00	QP
2	0.501000	23.99	10.08	34.07	46.00	-11.93	AVG
3 *	0.676400	40.73	10.07	50.80	56.00	-5.20	QP
4	0.676400	28.94	10.07	39.01	46.00	-6.99	AVG
5	0.968900	32.05	10.06	42.11	56.00	-13.89	QP
6	0.968900	23.17	10.06	33.23	46.00	-12.77	AVG
7	4.713000	30.22	9.82	40.04	56.00	-15.96	QP
8	4.713000	23.81	9.82	33.63	46.00	-12.37	AVG
9	11.850000	35.92	9.52	45.44	60.00	-14.56	QP
10	11.850000	25.84	9.52	35.36	50.00	-14.64	AVG
11	17.457000	35.90	9.44	45.34	60.00	-14.66	QP
12	17.457000	25.14	9.44	34.58	50.00	-15.42	AVG

EUT:	Apple Watch USB-C Charging Cable 3.3ft	Model Name:	AW3-WHT264607
Test Mode:	Mode 1	Phase :	N
Test Voltage:	DC 5V from adapter AC 120V/60Hz		

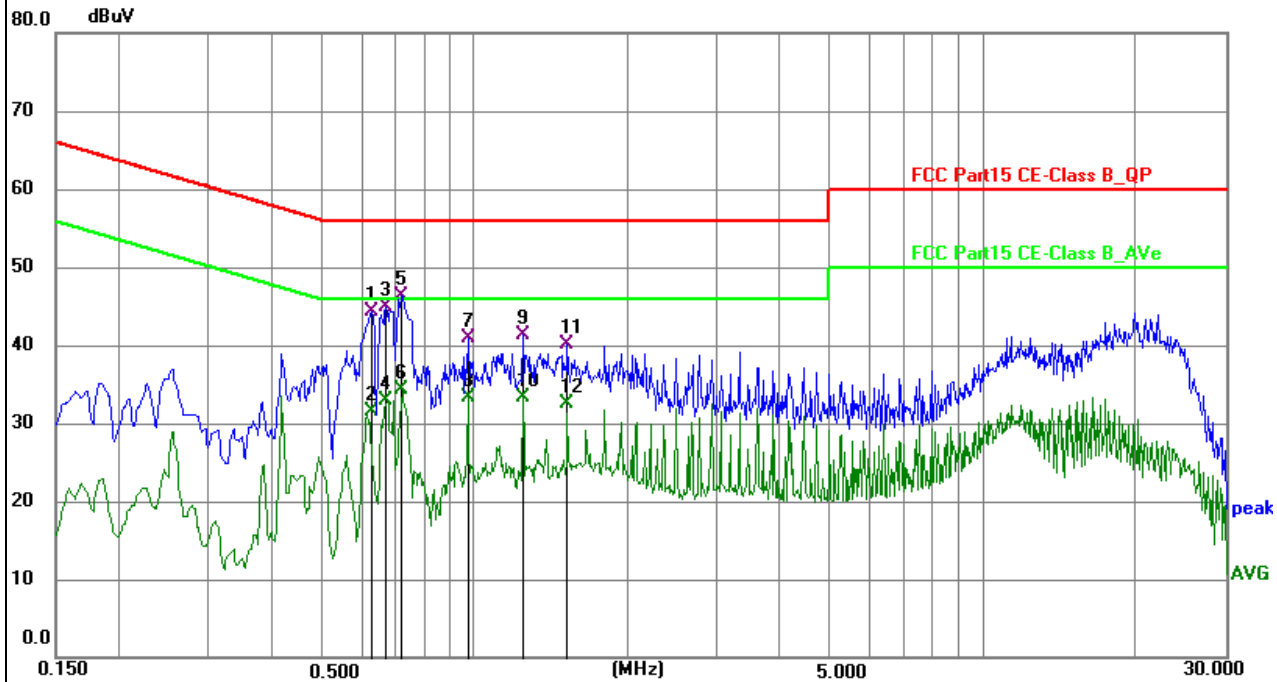

No.	Frequency (MHz)	Reading (dBuV)	Factor (dB)	Level (dBuV)	Limit (dBuV)	Margin (dB)	Detector
1	0.627000	34.22	10.07	44.29	56.00	-11.71	QP
2	0.627000	21.36	10.07	31.43	46.00	-14.57	AVG
3	0.667400	34.93	10.07	45.00	56.00	-11.00	QP
4	0.667400	22.92	10.07	32.99	46.00	-13.01	AVG
5 *	0.716900	36.33	10.06	46.39	56.00	-9.61	QP
6	0.716900	24.16	10.06	34.22	46.00	-11.78	AVG
7	0.968900	30.86	10.06	40.92	56.00	-15.08	QP
8	0.968900	23.30	10.06	33.36	46.00	-12.64	AVG
9	1.247900	31.30	10.05	41.35	56.00	-14.65	QP
10	1.247900	23.35	10.05	33.40	46.00	-12.60	AVG
11	1.526900	29.99	10.02	40.01	56.00	-15.99	QP
12	1.526900	22.55	10.02	32.57	46.00	-13.43	AVG

### 5.3 Radiated Emission

#### 5.3.1 Limits

Frequencies (MHz)	Field Strength (micorvolts/meter)	Measurement Distance (meters)
0.009~0.490	2400/F(KHz)	300
0.490~1.705	24000/F(KHz)	30
1.705~30.0	30	30
30~88	100	3
88~216	150	3
216~960	200	3
Above 960	500	3

Receiver Parameter	Setting
Attenuation	Auto
Start ~ Stop Frequency	9kHz~150kHz / RB 200Hz for QP
Start ~ Stop Frequency	150kHz~30MHz / RB 9kHz for QP
Start ~ Stop Frequency	30MHz~1000MHz / RB 120kHz for QP

#### 5.3.2 Test Procedures

- a) The radiated emission tests were performed in the 3 meters.
- b) The EUT was placed on the top of a rotating table 0.8 meters above the ground. The table was rotated 360 degrees to determine the position of the highest radiation.
- c) The height of the test antenna shall vary between 1m to 4m. Both horizontal and vertical polarizations of the antenna are set to make the measurement.
- d) If the peak mode measured value compliance with and lower than quasi peak mode limit, the EUT shall be deemed to meet QP limits and then no additional QP mode measurement performed.
- e) If the peak mode measured value compliance with and lower than average mode limit, the EUT shall be deemed to meet average limits and then no additional average mode measurement performed.
- f) For the actual test configuration, please refer to the related item – EUT test photos.

#### 5.3.3 Test Setup



Radiated Emission Test-Up Frequency Below 30MHz

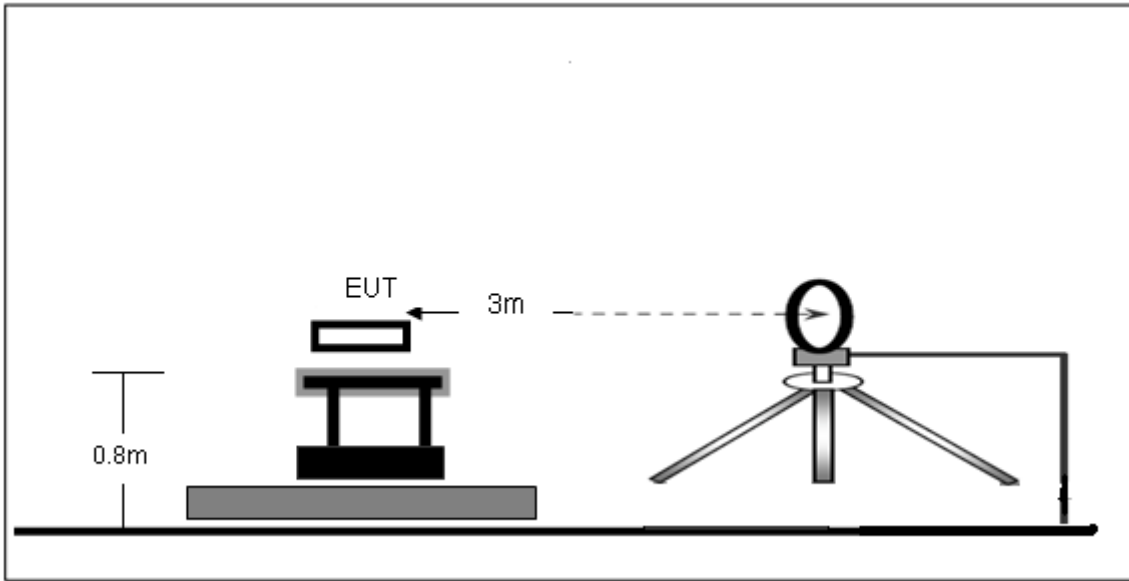

Radiated Emission Test-Up Frequency 30MHz~1GHz

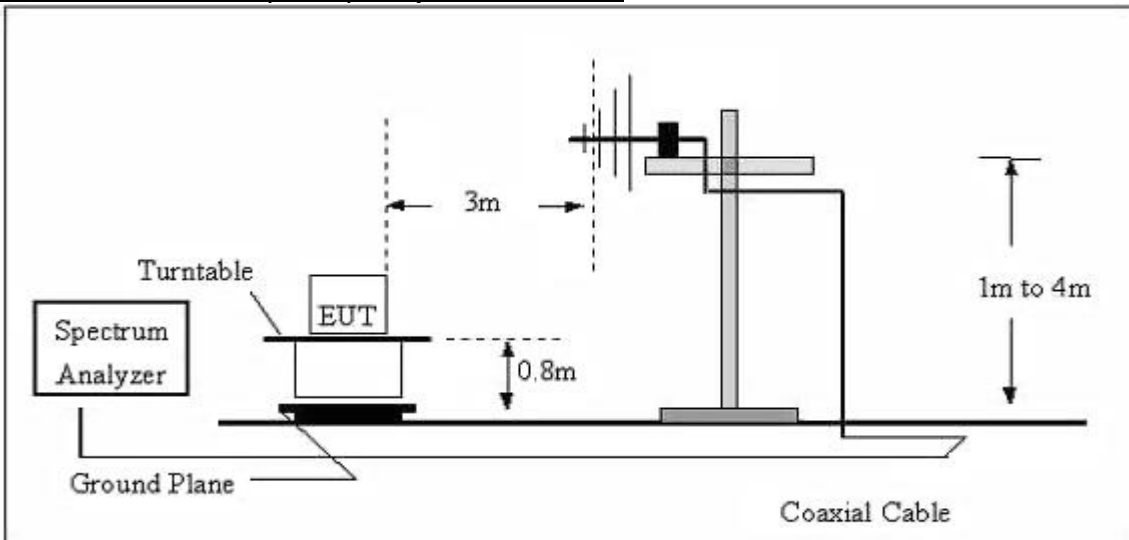

**5.3.4 Test Result**

Frequency range (9kHz – 30MHz)

EUT:	Apple Watch USB-C Charging Cable 3.3ft	Model Name:	AW3-WHT264607
Test Mode:	Mode 1	Phase:	Coaxial
Test Voltage:	DC 5V from adapter AC 120V/60Hz		

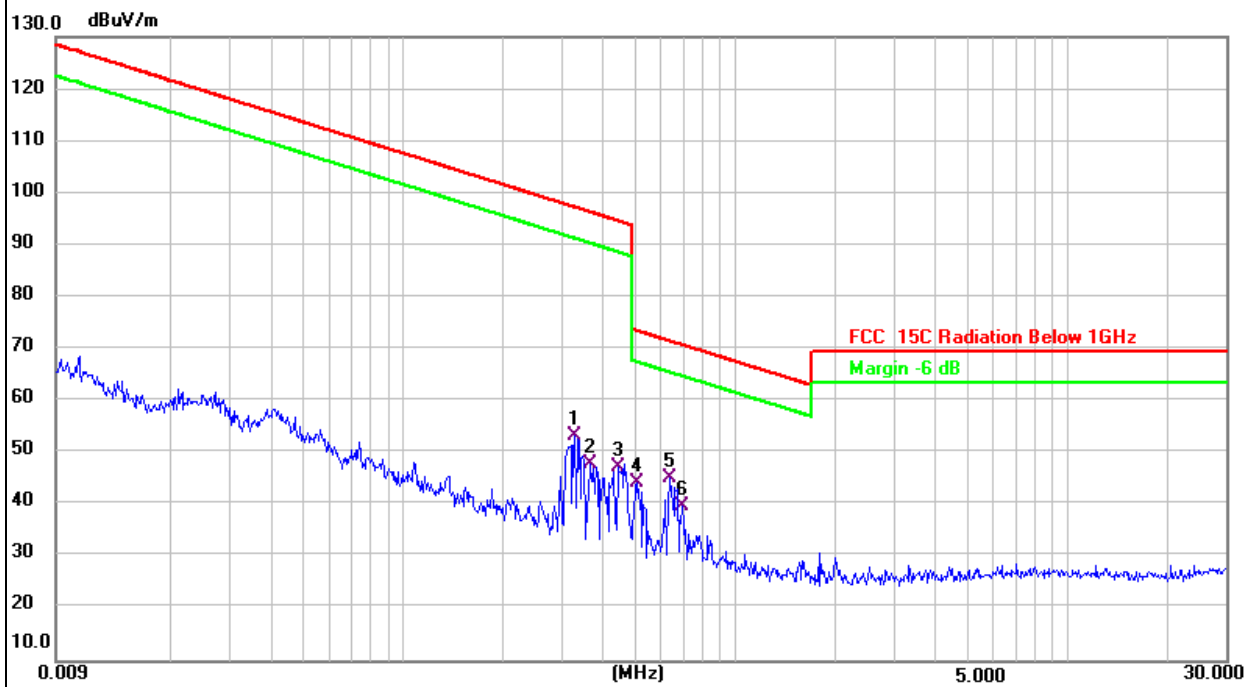

No.	Frequency (MHz)	Reading (dBuV)	Factor (dB/m)	Level (dBuV/m)	Limit (dBuV/m)	Margin (dB)	Detector
1	0.3271	33.99	19.29	53.28	97.32	-44.04	QP
2	0.3664	28.63	19.29	47.92	96.33	-48.41	QP
3	0.4415	27.98	19.31	47.29	94.71	-47.42	QP
4	0.5030	25.02	19.34	44.36	73.57	-29.21	QP
5 *	0.6360	25.75	19.35	45.10	71.54	-26.44	QP
6	0.6902	19.01	20.73	39.74	70.83	-31.09	QP

Frequency range (30MHz – 1GHz)

EUT:	Apple Watch USB-C Charging Cable 3.3ft	Model Name:	AW3-WHT264607
Test Mode:	Mode 1	Phase:	Vertical
Test Voltage:	DC 5V from adapter AC 120V/60Hz		



No.	Frequency (MHz)	Reading (dBuV)	Factor (dB/m)	Level (dBuV/m)	Limit (dBuV/m)	Margin (dB)	Detector
1	34.2760	47.57	-15.10	32.47	40.00	-7.53	QP
2 *	43.6584	51.09	-14.18	36.91	40.00	-3.09	QP
3 !	46.6664	50.52	-14.32	36.20	40.00	-3.80	QP
4 !	87.4177	53.47	-19.13	34.34	40.00	-5.66	QP
5	159.7844	50.71	-13.64	37.07	43.50	-6.43	QP
6 !	205.6751	55.24	-16.64	38.60	43.50	-4.90	QP

EUT:	Apple Watch USB-C Charging Cable 3.3ft	Model Name:	AW3-WHT264607
Test Mode:	Mode 2	Phase:	Horizontal
Test Voltage:	DC 5V from adapter AC 120V/60Hz		

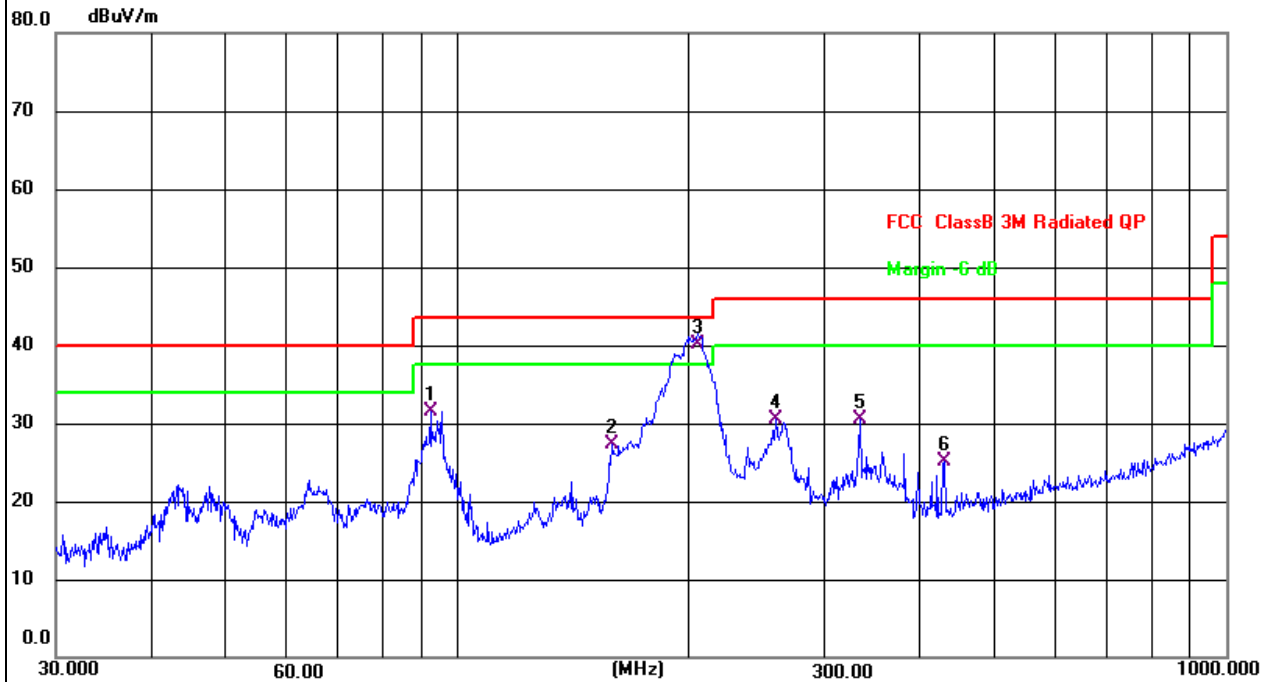

No.	Frequency (MHz)	Reading (dBuV)	Factor (dB/m)	Level (dBuV/m)	Limit (dBuV/m)	Margin (dB)	Detector
1	92.1388	50.48	-19.03	31.45	43.50	-12.05	QP
2	158.6677	40.88	-13.67	27.21	43.50	-16.29	QP
3 *	205.6751	56.76	-16.64	40.12	43.50	-3.38	QP
4	259.2338	44.94	-14.43	30.51	46.00	-15.49	QP
5	333.6867	42.64	-12.07	30.57	46.00	-15.43	QP
6	429.5228	34.40	-9.31	25.09	46.00	-20.91	QP

## 5.4 Occupied Bandwidth

### 5.4.1 Test method

Use the following spectrum analyzer settings:

Span = approximately 2 to 3 times the 20 dB bandwidth, centered on a hopping channel

RBW  $\geq 1\%$  of the 20 dB bandwidth

VBW  $\geq$  RBW

Sweep = auto

Detector function = peak

Trace = max hold

The EUT should be transmitting at its maximum data rate. Allow the trace to stabilize. Use the marker-to-peak function to set the marker to the peak of the emission. Use the marker-delta function to measure 20 dB down one side of the emission. Reset the marker-delta function, and move the marker to the other side of the emission, until it is (as close as possible to) even with the reference marker level. The marker-delta reading at this point is the 20 dB bandwidth.

### 5.4.2 Test result

Frequency (kHz)	20dB emission bandwidth (Hz)
326.5	749.30

Watch Test plots as below:

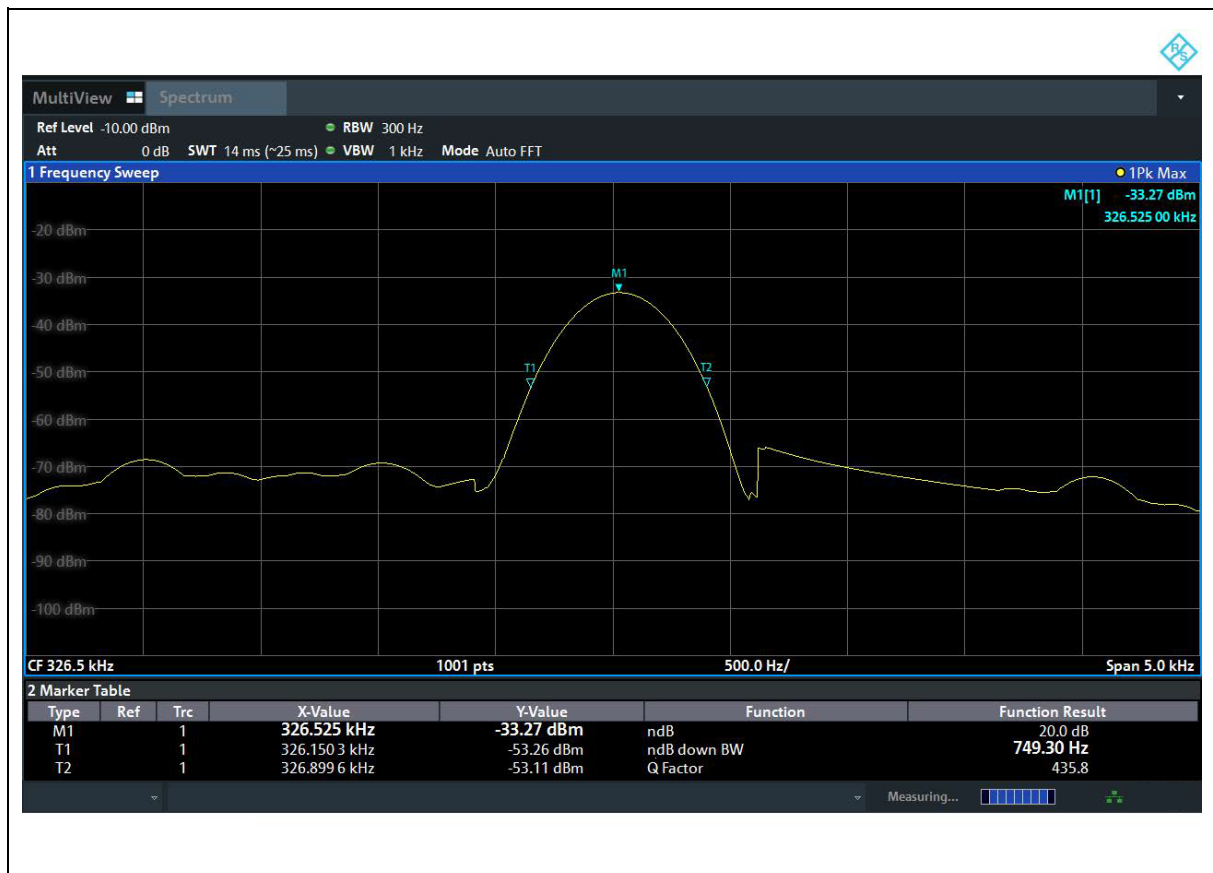

Frequency (kHz)	20dB emission bandwidth (Hz)
1778	749.30

Watch Test plots as below:

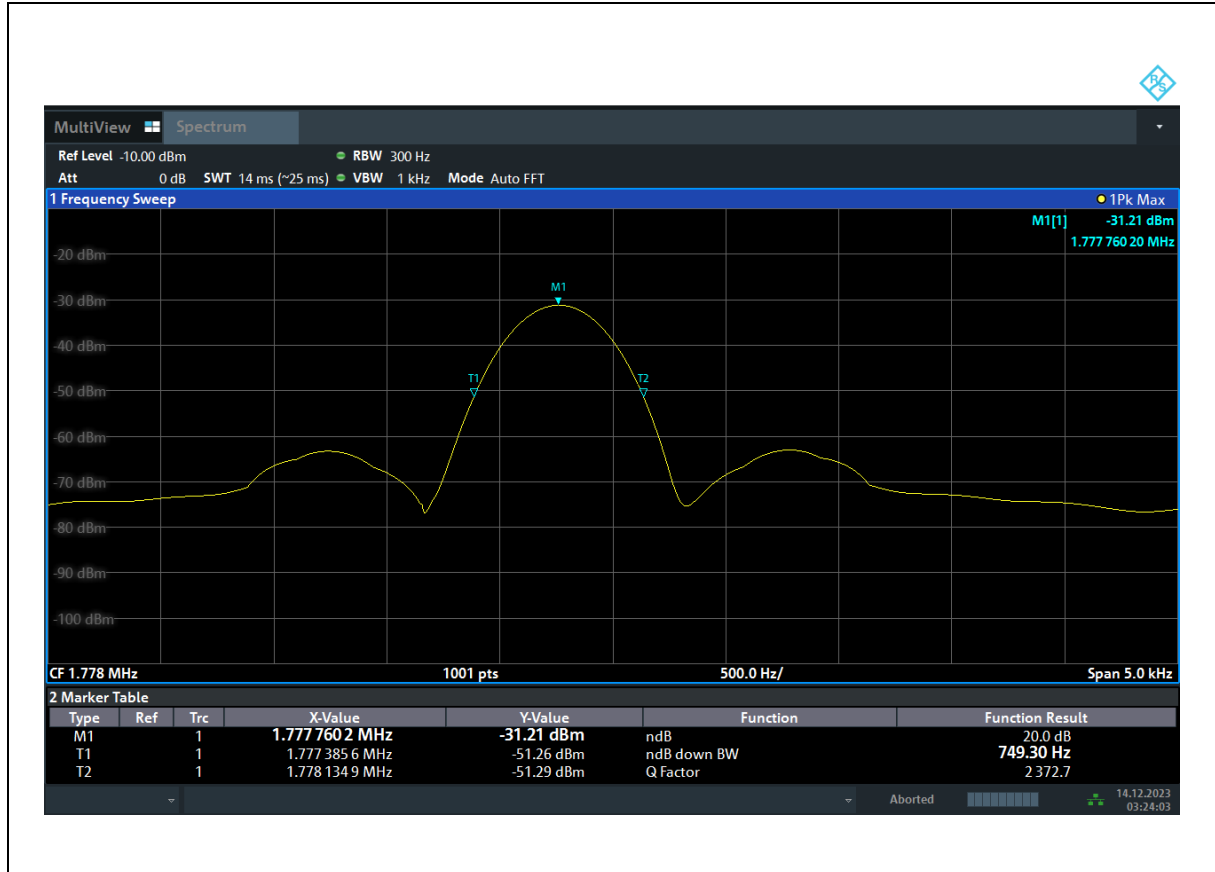



## 6 Photographs of the Test Setup

Radiated Emission Below 30MHz

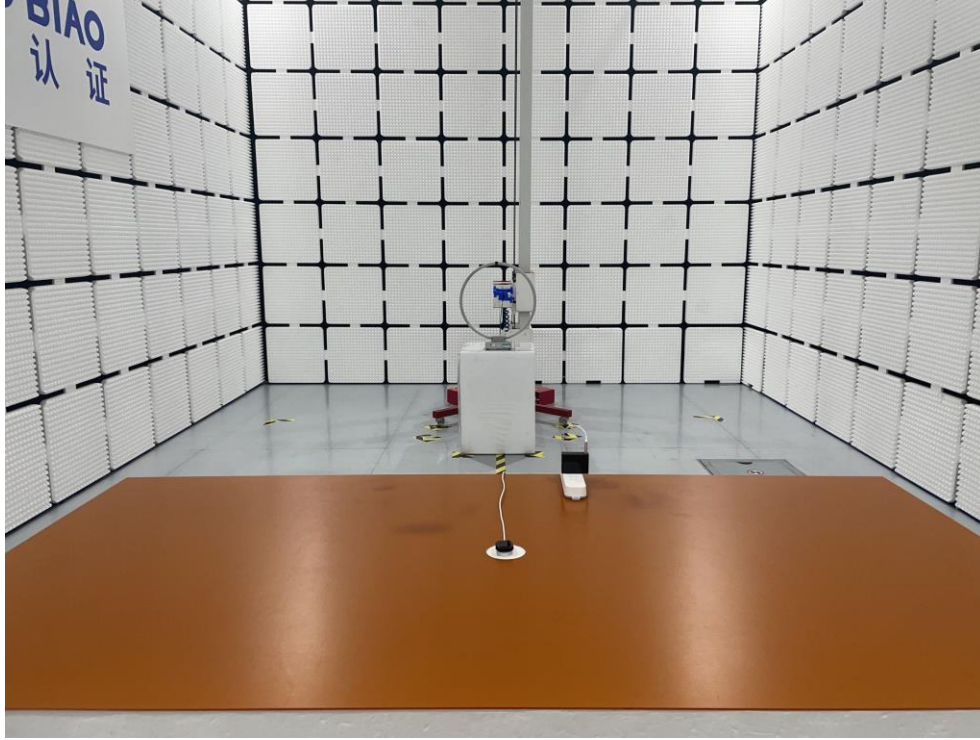

Radiated Emission Above 30MHz

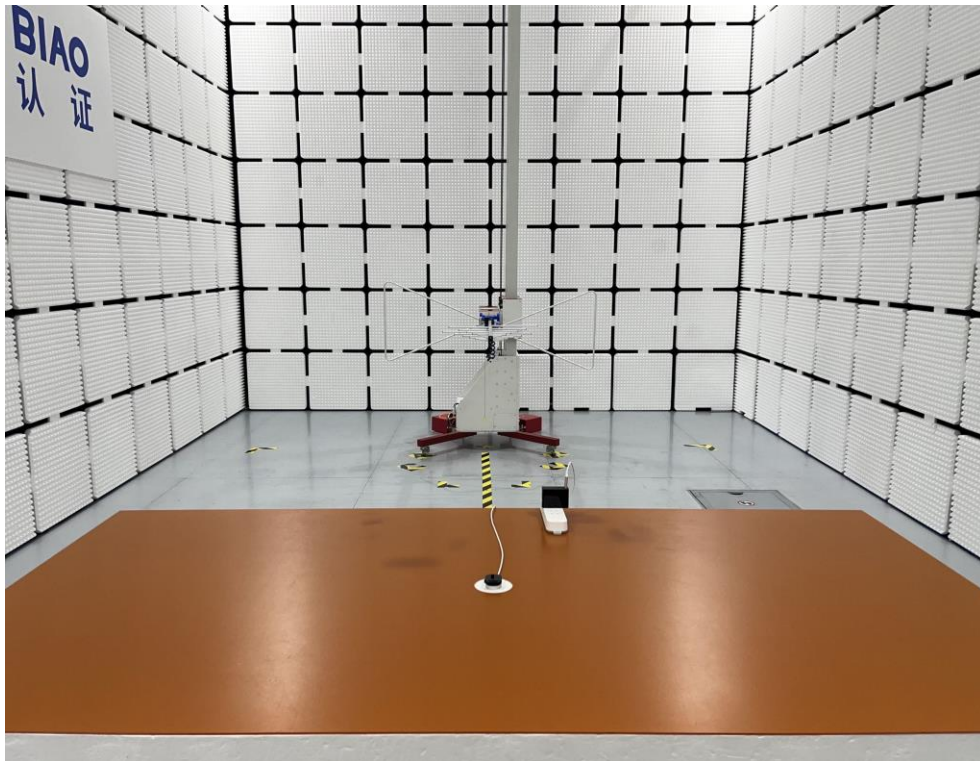

Conducted emission

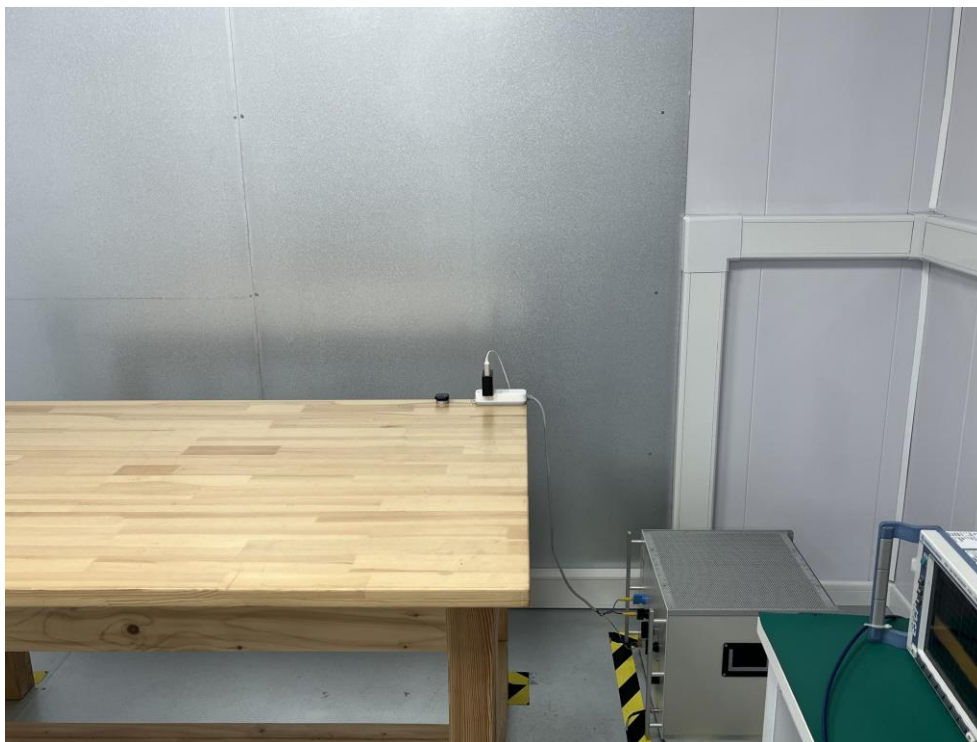



## 7 Photographs of the EUT

Photo 1

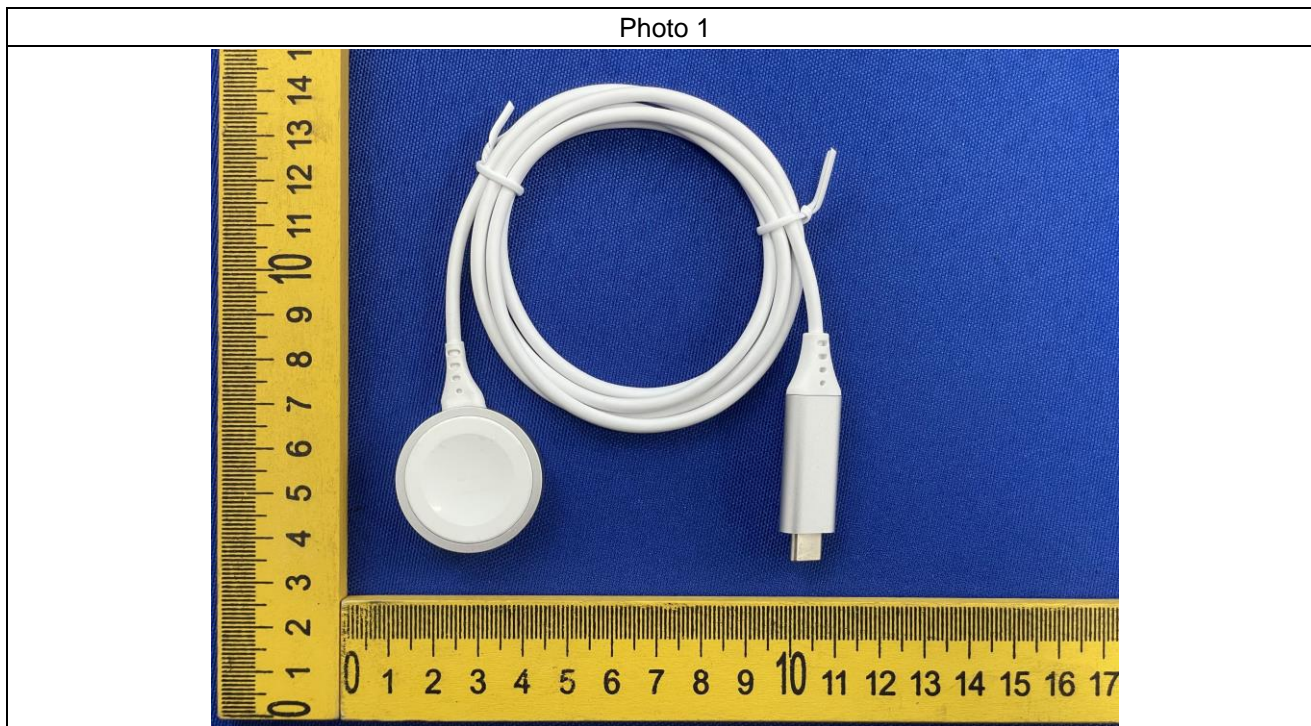

Photo 2

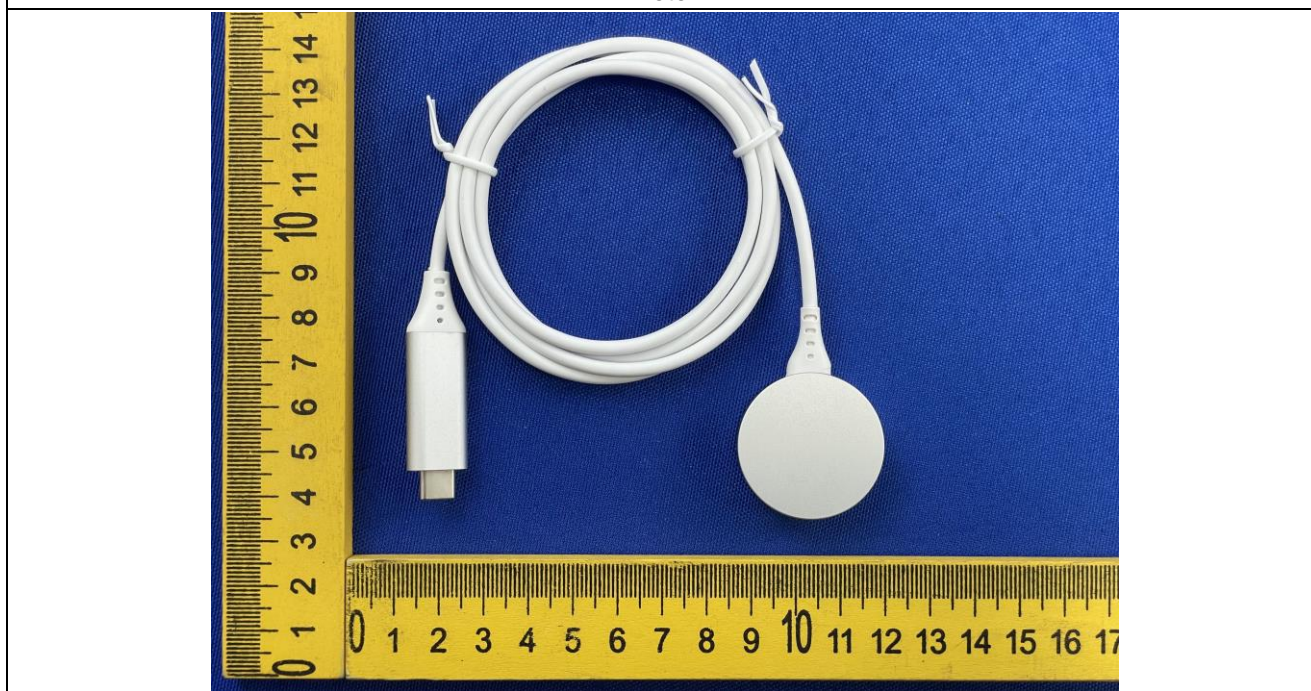

Photo 3



Photo 4





Photo 5

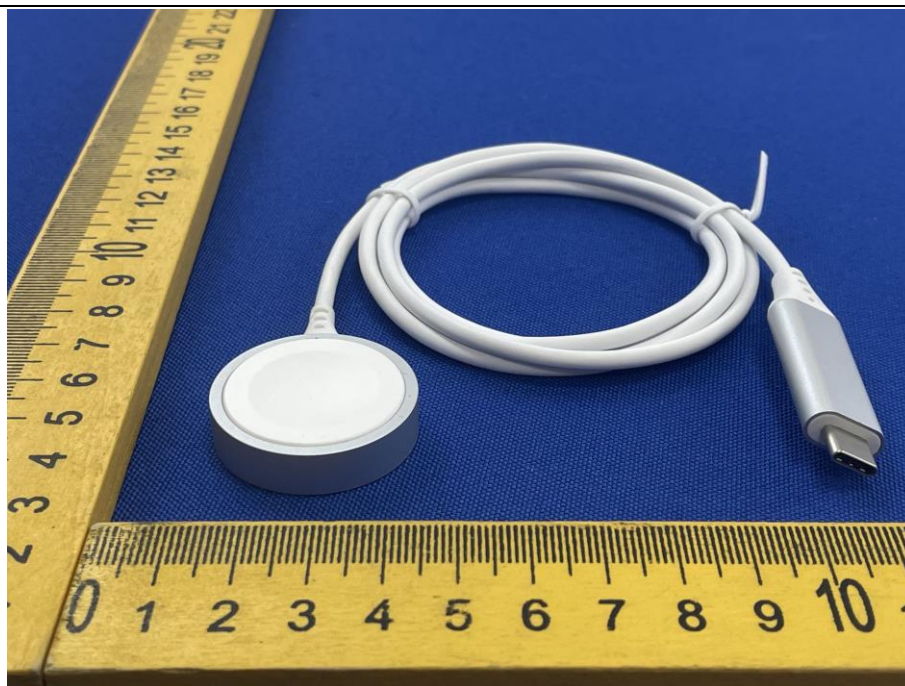

Photo 6



Photo 7

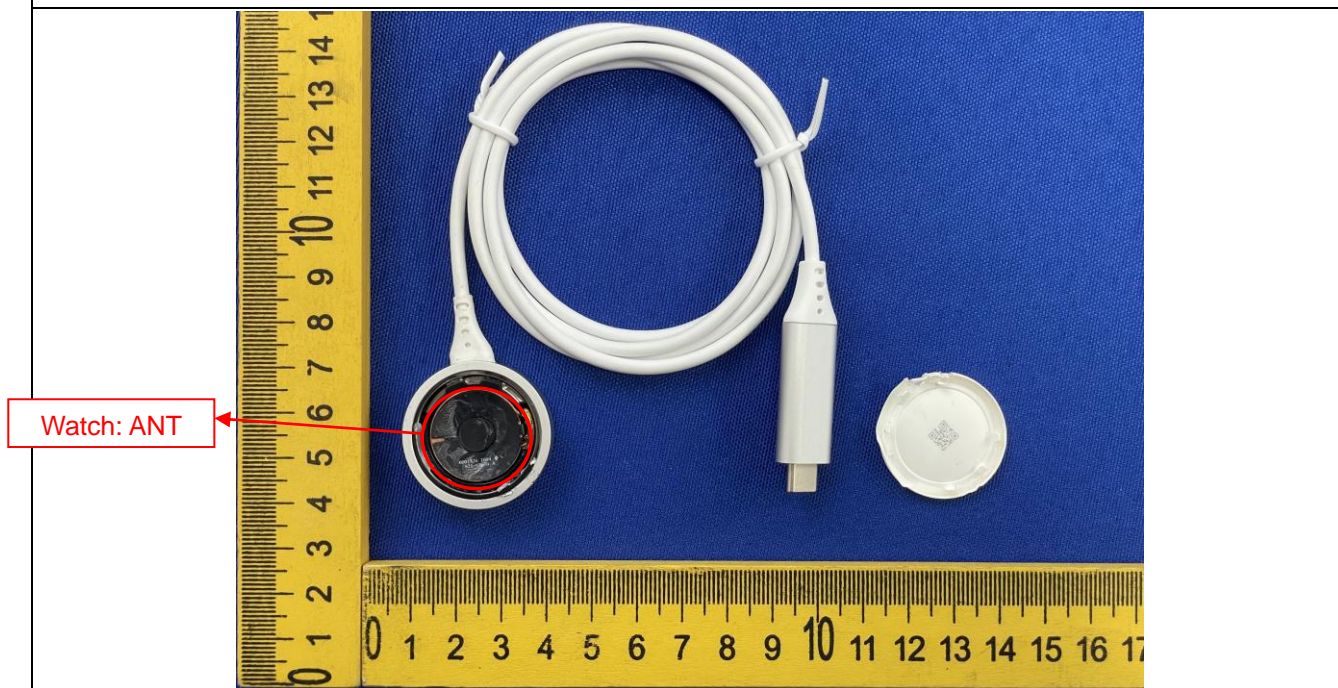

Photo 8





Photo 9



Photo 10





Photo 11



Photo 12

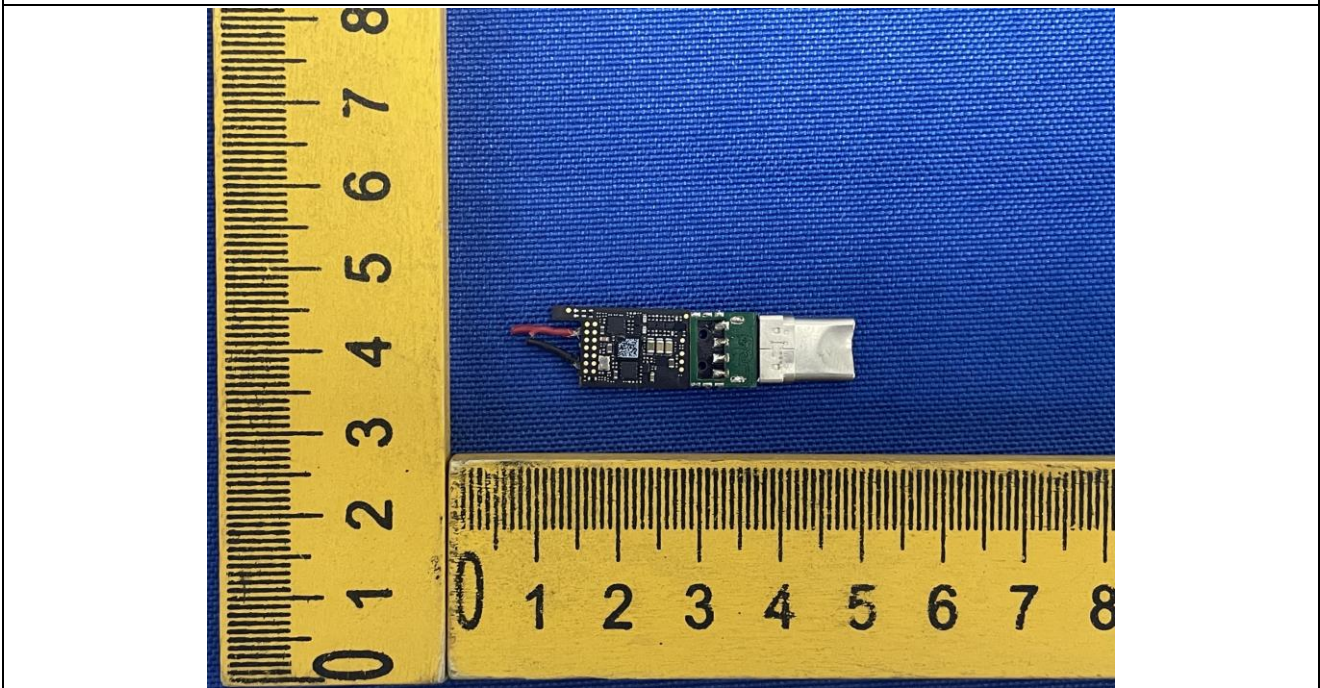
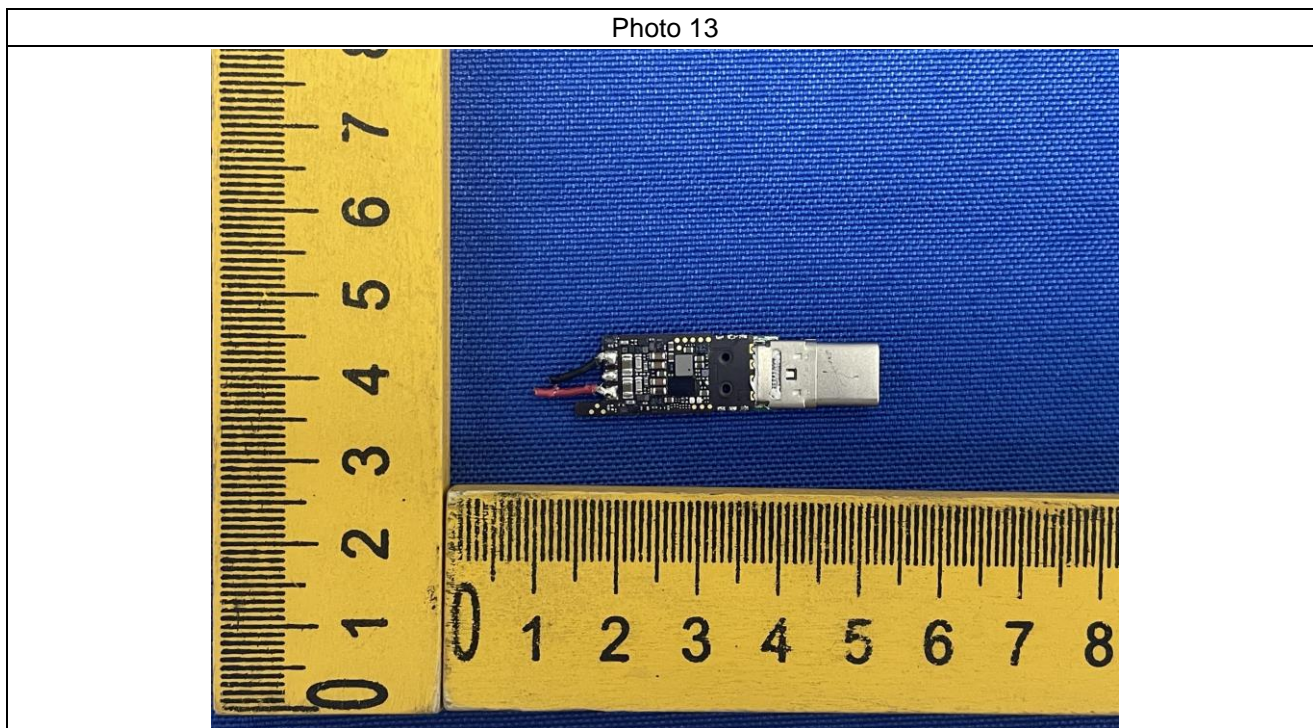

Photo 13



\*\*\*\*\* END OF REPORT \*\*\*\*\*