

FCC Test Report

Part 15 Subpart C

FCC ID: 2A3WGOA70110

Client Information:

Applicant: Delta Energy & Communications, Inc

Applicant add.: 29975 Technology Drive, Suite 101, Murrieta, CA 92563+19518166338,
info@deltaglobalnetwork.com

Product Information:

EUT Name: DataVINE™ Mesh Card

Model No.: DEC-O-A-701-10

Brand Name: DELTA

Serial Model: N/A

Standards: FCC PART 15 Subpart C: 2015 section 15.247

AA Electro Magnetic Test Laboratory Private Limited

Add. : Plot No 174, Udyog Vihar - Phase 4, Sector 18,
Gurgaon, Haryana, India

Date of Receipt: Feb. 08, 2022

Date of Test: Feb. 09 ~ Mar. 03, 2022

Date of Issue: Mar. 15, 2022

Test Result: Pass

Declaration of Conformity: Declaration of conformity of the results is based as per the standard limits

This device described above has been tested by AA Electro Magnetic Test Laboratory Private Limited, and the test results show that the equipment under test (EUT) is in compliance with the FCC requirements. And it is applicable only to the tested sample identified in the report.

*This test report must not be used by the client to claim product endorsement by any agency of the U.S. government.

Prepared By (+ signature) Abhinav Kumar:



Reviewed & Approved by: (+ signature)



Dr. Lenin Raja (Authorized Representative)

(/ lenin83/)

1 Contents

	Page
COVER PAGE	
1 CONTENTS	2
2 VERSION	3
3 TEST SUMMARY	4
3.1 COMPLIANCE WITH FCC PART 15 SUBPART C	4
3.2 MEASUREMENT UNCERTAINTY	5
3.3 TEST LOCATION	5
4 TEST FACILITY	6
4.1 DEVIATION FROM STANDARD	6
4.2 ABNORMALITIES FROM STANDARD CONDITIONS	6
5 GENERAL INFORMATION	7
5.1 GENERAL DESCRIPTION OF EUT	7
5.2 EUT PERIPHERAL LIST	9
5.3 TEST PERIPHERAL LIST	9
6 EQUIPMENTS LIST FOR ALL TEST ITEMS	10
7 TEST RESULT	12
7.1 DESCRIPTION OF TEST CONDITIONS	12
7.2 ANTENNA REQUIREMENT	13
7.3 CONDUCTION EMISSIONS MEASUREMENT	14
7.4 RADIATED EMISSIONS MEASUREMENT	18
7.5 6 DB BANDWIDTH	50
7.6 MAXIMUM PEAK OUTPUT POWER	63
7.7 PEAK POWER SPECTRAL DENSITY	66
7.8 BAND EDGES REQUIREMENT	75
7.9 CONDUCTED SPURIOUS EMISSIONS	89

2 Version

Revision Record				
Version	Chapter	Date	Modifier	Remark
--	--	--	--	--
--	--	--	--	--
--	--	--	--	--
--	--	--	--	--

3 Test Summary

3.1 Compliance with FCC Part 15 subpart C

TEST	TEST REQUIREMENT	TEST METHOD	RESULT
Antenna Requirement	FCC PART 15 C section 15.247 (c) and Section 15.203	FCC PART 15 C section 15.247 (c) and Section 15.203	PASS
Conducted Emissions at Mains Terminals	FCC PART 15 C section 15.207	ANSI C63.10: Clause 6.2	PASS
Radiated Spurious Emission (30 MHz to 25 GHz)	FCC PART 15 C section 15.209 &15.247(d)	ANSI C63.10: Clause 6.4, 6.5 and 6.6	PASS
6 dB Bandwidth	FCC PART 15 C section 15.247 (a)(2)	ANSI C63.10: Clause 6.9.1	PASS
Maximum Peak Output Power	FCC PART 15 C section 15.247(b)(3)	FCC/KDB-558074 D01 v03r01 Clause 9.1.2	PASS
Peak Power Spectral Density	FCC PART 15 C section 15.247(e)	ANSI C63.10: Clause 6.11.2.3	PASS
Band Edges Measurement	FCC PART 15 C section 15.247 (d) &15.205	FCC/KDB-558074 D01 v03r01 Clause 13.3.1	PASS
Conducted Spurious Emission (30MHz to 25GHz)	FCC PART 15 C section 15.209 &15.247(d)	ANSI C63.10: Clause 6.7	PASS

Remark:

N/A: not applicable. Refer to the relative section for the details.

EUT: In this whole report EUT means Equipment Under Test.

Tx: In this whole report Tx (or tx) means Transmitter.

Rx: In this whole report Rx (or rx) means Receiver.

RF: In this whole report RF means Radio Frequency.

ANSI C63.10: the detail version is ANSI C63.10:2013 in the whole report.

3.2 Measurement Uncertainty

All measurements involve certain levels of uncertainties, the following measurements uncertainty Levels have estimated based on standards, the maximum value of the uncertainty as below:

No.	Item	Uncertainty
1	Conducted Emission Test	2.67dB
2	Radiated Emission Test	3.06dB

3.3 Test Location

All tests were performed at:

AA Electro Magnetic Test Laboratory Private Limited

Plot No 174, Udyog Vihar - Phase 4, Sector 18, Gurgaon, Haryana, India

Tel.: +91-0124-4235350

4 Test Facility

The test facility is recognized, certified or accredited by the following organizations:

ILAC / NABL Accreditation No.: TC-8597

Three 3m Semi-Anechoic Chamber, 1 full-Anechoic chamber and 2 Shielding Rooms of AA Electro Magnetic Test Laboratory Private Limited have been registered by National Accreditation Board for Testing and Calibration Laboratories (NABL).

ILAC –A2LA Accreditation No.: 5593.01

Three 3m Semi-Anechoic Chamber, 1 full-Anechoic chamber and 2 Shielding Rooms of AA Electro Magnetic Test Laboratory Private Limited have been registered American Association of Laboratory Accreditation (A2LA.)

FCC- Recognition No.: 137777

Three 3m Semi-Anechoic Chamber, 1 full-Anechoic chamber and 2 Shielding Rooms of AA Electro Magnetic Test Laboratory Private Limited have been registered by Federal Communications Commission (FCC).

ISED Recognition No.: 26046

Three 3m Semi-Anechoic Chamber, 1 full-Anechoic chamber and 2 Shielding Rooms of AA Electro Magnetic Test Laboratory Private Limited have been registered by Institute for Social and Economic Development.(ISED)

VCCI- Registration No: 4053

Three 3m Semi-Anechoic Chamber, 1 full-Anechoic chamber and 2 Shielding Rooms of AA Electro Magnetic Test Laboratory Private Limited have been registered by Voluntary Control Council for Interference.(VCCI)

TEC Designation No.: IND063

Three 3m Semi-Anechoic Chamber, 1 full-Anechoic chamber and 2 Shielding Rooms of AA Electro Magnetic Test Laboratory Private Limited have been registered by Telecommunication Engineering (TEC) Center.

BIS Recognition No: 816586

BIS recognized as per CRS scheme for IT electronics, LED control gears, Lamp, Inverter / UPS are recognized as per LRS 2020.

4.1 Deviation from standard

None

4.2 Abnormalities from standard conditions

None

5 General Information

5.1 General Description of EUT

Manufacturer:	VVDN Technologies Pvt. Ltd.		
Manufacturer Address:	Plot No: CP-07, Sector-8,IMT Manesar, Gurugram, Haryana - 122050		
EUT Name:	DataVINE™ Mesh Card		
Model No:	DEC-O-A-701-10		
Brand Name:			
Derivative model No.:	N/A		
Operation frequency:	2412 MHz to 2462 MHz for 802.11b/g/n(HT20) 2422 MHz to 2452 MHz for 802.11n(HT40)		
Number of Channels:	11 Channels for 802.11b/g/n(HT20) 7 Channels for 802.11n(HT40)		
Modulation Technology:	802.11b: CCK/DQPSK/DBPSK 802.11g/n: BPSK/QPSK/16QAM/64QAM		
Transmit Data Rate:	802.11b :1/2/5.5/11 Mbps 802.11g :6/9/12/18/24/36/48/54 Mbps 802.11n(HT20): 7.2/14.4/21.7/28.9/43.3/57.8/65/72.2 Mbps 802.11n(HT40): 15/30/45/60/90/120/135/150 Mbps		
Channel Separation:	5 MHz		
Antenna Type:	Integrated Patch Antenna		
Antenna Gain:	4dBi		
Antenna Function Description:		802.11b/g 802.11nHT20	ANT J4
		802.11b/g 802.11nHT20 802.11nHT40	ANT J2
H/W No.:	703-1-01204_B1		
S/W No.:	0.0.0.26		
Power Supply Range:	Input: 4VDC/2A and 12VDC/1A		
Condition of Sample on receipt:	Good		
Note:			
	1.	For a more detailed features description, please refer to the manufacturer's specifications or the User's Manual.	

EUT channels and frequencies list:

1. Test frequencies are lowest channel: 2412 MHz, middle channel: 2437 MHz and highest channel: 2462 MHz for 802.11b/g/n(HT20)

Channel	Frequency (MHz)	Channel	Frequency (MHz)
1	2412	7	2442
2	2417	8	2447
3	2422	9	2452
4	2427	10	2457
5	2432	11	2462
6	2437		

2. Test frequencies are lowest channel: 2422 MHz, middle channel: 2437 MHz and highest channel: 2452 MHz for 802.11n(HT40)

Channel	Frequency (MHz)	Channel	Frequency (MHz)
3	2422	7	2442
4	2427	8	2447
5	2432	9	2452
6	2437		

5.2 EUT Peripheral List

No.	Equipment	Manufacturer	Model No.	Serial No.	Power cord	signal cable
1.	N/A	N/A	N/A	N/A	N/A	N/A

5.3 Test Peripheral List

No.	Equipment	Manufacturer	Model No.	Serial No.	Power cord	signal cable
1	Laptop	DELL	Latitude 3490	5M2Z1W2	2m unshielded	N/A

6 Equipments List for All Test Items

No	Test Equipment	Manufacturer	Model No	Serial No	Cal. Date	Cal. Due Date
1	Spectrum Analyzer	Rohde and Schwarz	FSP40	101163	2020/12/11	2022/12/10
2	Loop antenna	DAZE Beijing	ZN30900C	18052	2021/01/29	2023/01/28
3	Hi power horn antenna	DAZE Beijing	ZN30700	18012	2021/01/30	2023/01/29
4	Horn antenna	DAZE Beijing	ZN30702	18006	2021/01/30	2023/01/29
5	Horn antenna	DAZE Beijing	ZN30703	18005	2021/01/30	2023/01/29
6	Preamplifier	KELIANDA	LNA-0009295	-	2021/01/13	2023/01/13
7	Preamplifier	KELIANDA	CF-00218	-	2021/01/13	2023/01/13
8	Bi conical Antenna	DAZE Beijing	ZN30505C	17038	2021/01/28	2023/01/29
9	EMI-RECEIVER	Schwarzbeck	FCKL	1528194	2021/01/13	2023/01/13
10	Spectrum Analyzer	ADVANTEST	R3162	-	2021/01/13	2023/01/13
11	LISN	Kyoritsu	KNW-407	8-1789-5	2021/01/13	2023/01/13
12	Network-LISN	Schwarzbeck	NNBM8125	81251314	2021/01/13	2023/01/13
13	Network-LISN	Schwarzbeck	NNBM8125	81251315	2021/01/13	2023/01/13
14	PULSELIMITER	Rohde and Schwarz	ESH3-Z2	100681	2021/05/12	2022/05/11
15	50ΩCoaxialSwitch	DAIWA	1565157	-	2021/05/12	2022/05/11
16	50ΩCoaxialSwitch	-	-	-	2021/05/12	2022/05/11
17	Wireless signal power meter	DARE!!	RPR3006W	RFSW190220	2021/01/13	2023/01/13
18	Signal Generator	KEYSIGHT	N5181A	512071	2021/01/13	2023/01/13
19	RF Vector Signal Generator	Keysight	N5182B	512094	2021/01/13	2023/01/13



Report No.: AAEMT/EMC/220208-01-02

20	Spectrum analyzer	R&S	FSV-40N	101385	2021/01/13	2023/01/13
21	Radio Communication Tester	R&S	CMW 500	124589	2021/5/14	2022/5/13
22	Signal Generator	R&S	SMP02	837017/004 836593/005	2021/5/14	2022/5/13
23	DC Power Supply	Guanker	JK15040K	TNC/ET/C/0 01/15	2021/02/02	2023/02/01
24	Pro. Temp & Humi. chamber	MENTEK	MHP-150-1C	MAA081125 01	2021/02/02	2023/02/01
25	Attenuators	AGILENT	8494B	-	-	-
26	Attenuators	AGILENT	8495B	-	-	-

7 Test Result

7.1 Description of Test conditions

- (1) EUT was tested in normal configuration (Please See following Block diagram)

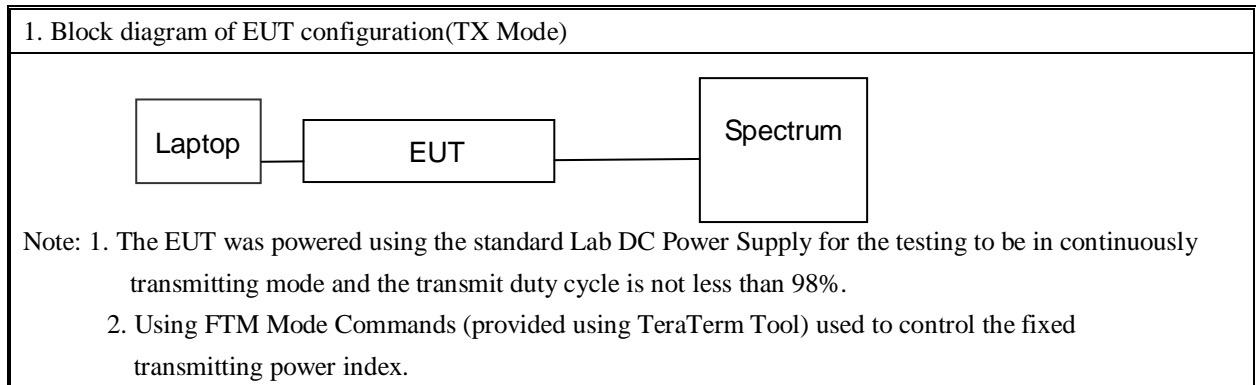

- (2) E.U.T. test conditions:

15.31(e): For intentional radiators, measurements of the variation of the input power or the radiated signal level of the fundamental frequency component of the emission, as appropriate, shall be performed with the supply voltage varied between 85% and 115% of the nominal rated supply voltage. For battery operated equipment, the equipment tests shall be performed using a new battery.

15.32: Power supplies and CPU boards used with personal computers and for which separate authorizations are required to be obtained shall be tested as follows: Testing shall be in accordance with the procedures specified in Section 15.31 of this part.

- (3) Test frequencies:

According to the 15.31(m) Measurements on intentional radiators or receivers, other than TV broadcast receivers, shall be performed and. If required reported for each band in which the device can be operated with the device operating at the number of frequencies in each band specified in the following table:

Frequency range over which device operates	Number of frequencies	Location in the range of operation
1 MHz or less	1	Middle
1 to 10 MHz	2	1 near top and 1 near bottom
More than 10 MHz	3	1 near top, 1 near middle and 1 near bottom

- (4) Frequency range of radiated measurements:

According to the 15.33, the test range will be up to the tenth harmonic of the highest fundamental frequency.

- (5) Pre-test the EUT in all transmitting mode at the lowest, middle and highest channel with different data rate and conducted to determine the worst-case mode, only the worst-case results are recorded in this report.

7.2 Antenna Requirement

7.2.1 Standard requirement

15.203 requirement: For intentional device, according to 15.203: an intentional radiator shall be designed to ensure that no antenna other than that furnished by the responsible party shall be used with the device.

15.247(c) (1)(i) requirement: (i) Systems operating in the 2400-2483.5 MHz band that is used exclusively for fixed. Point-to-point operations may employ transmitting antennas with directional gain greater than 6dBi provided the maximum conducted output power of the intentional radiator is reduced by 1 dB for every 3 dB that the directional gain of the antenna exceeds 6dBi.

7.2.2 EUT Antenna

The antenna is an Integrated Patch Antenna which is connected to the board via U.FL connector. Antenna gain is maximum 4dBi from 2.4GHz to 2.5 GHz

7.3 Conduction Emissions Measurement

Test Requirement: FCC Part 15 C section 15.207
Test Method: ANSI C63.10: Clause 6.2
Frequency Range: 150 kHz to 30 MHz
Detector: Peak for pre-scan (9kHz Resolution Bandwidth)
Test Limit

Frequency Range (MHz)	Limit (dB μ V)	
	Quasi-peak	Average
0.15 to 0.50	66 to 56	56 to 46
0.50 to 5	56	46
5 to 30	60	50

NOTE 1 The limit decreases linearly with the logarithm of the frequency in the range 0,15 MHz to 0,50 MHz.

EUT Operation: Test in normal operating mode. For intentional radiators, measurements of the variation of the input power or the radiated signal level of the fundamental frequency component of the emission, as appropriate, shall be performed with the supply voltage varied between 85% and 115% of the nominal rated supply voltage.

Pre-Scan has been conducted to determine the worst-case mode from all possible combinations between available modulations, data rates and antenna ports (if EUT with antenna diversity architecture).

Test procedure

1. The mains terminal disturbance voltage test was conducted in a shielded room.
2. The EUT was connected to AC power source through a LISN 1 (Line Impedance Stabilization Network) which provides 50 Ω /50 μ H + 5 Ω linear impedance. The power cables of all other units of the EUT were connected to a second LISN 2, which was bonded to the ground reference plane in the same way as the LISN 1 for the unit being measured. A multiple socket outlet strip was used to connect multiple power cables to a single LISN provided the rating of the LISN was not exceeded.
3. The tabletop EUT was placed upon a non-metallic table 0.8m above the ground reference plane. And for floor-standing arrangement, the EUT was placed on the horizontal ground reference plane, but separated from metallic contact with the ground reference plane by 0.1m of insulation.
4. The test was performed with a vertical ground reference plane. The rear of the EUT shall be 0,4 m from the vertical ground reference plane. The vertical ground reference plane was bonded to the horizontal ground reference plane. The LISN 1 was placed 0,8 m from the boundary of the unit under test and bonded to a ground reference plane for LISNs mounted on top of the ground reference plane. This distance was between the closest points of the LISN 1 and the EUT. All other units of the EUT and associated equipment was at least 0,8 m from the LISN 2.

Test setup

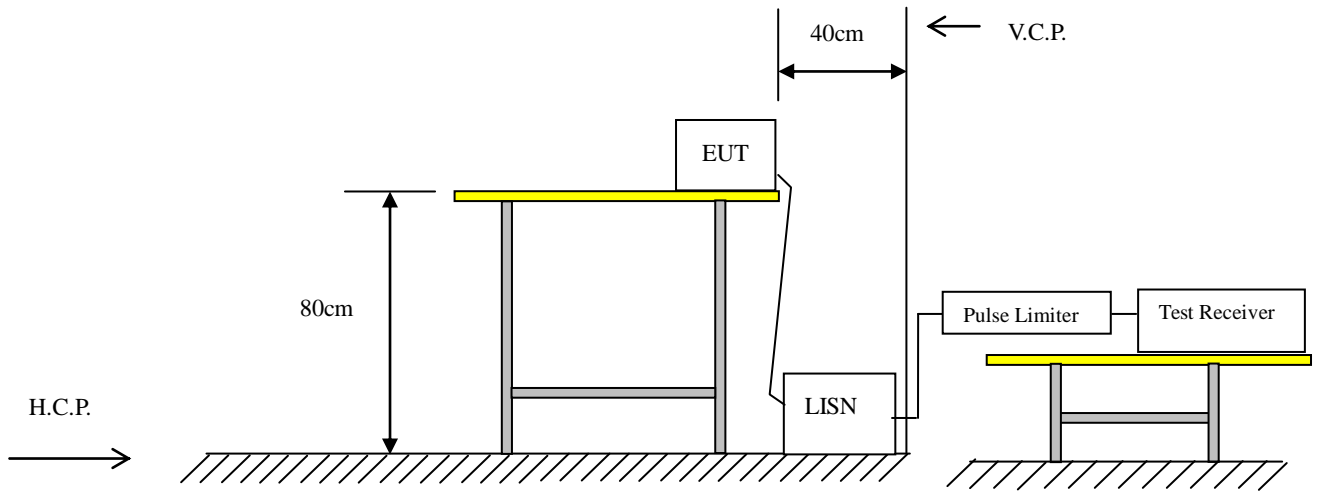

7.3.1 Test results

EUT:	DataVINE™ Mesh Card	Model Name. :	DEC-O-A-701-10
Temperature:	24 °C	Relative Humidity:	50%
Pressure:	1010hPa	Test Date :	2022-02-09
Test Mode:	TX (11Mbps) CH1 (worst case)	Phase :	Positive
Test Voltage :	DC 12V		

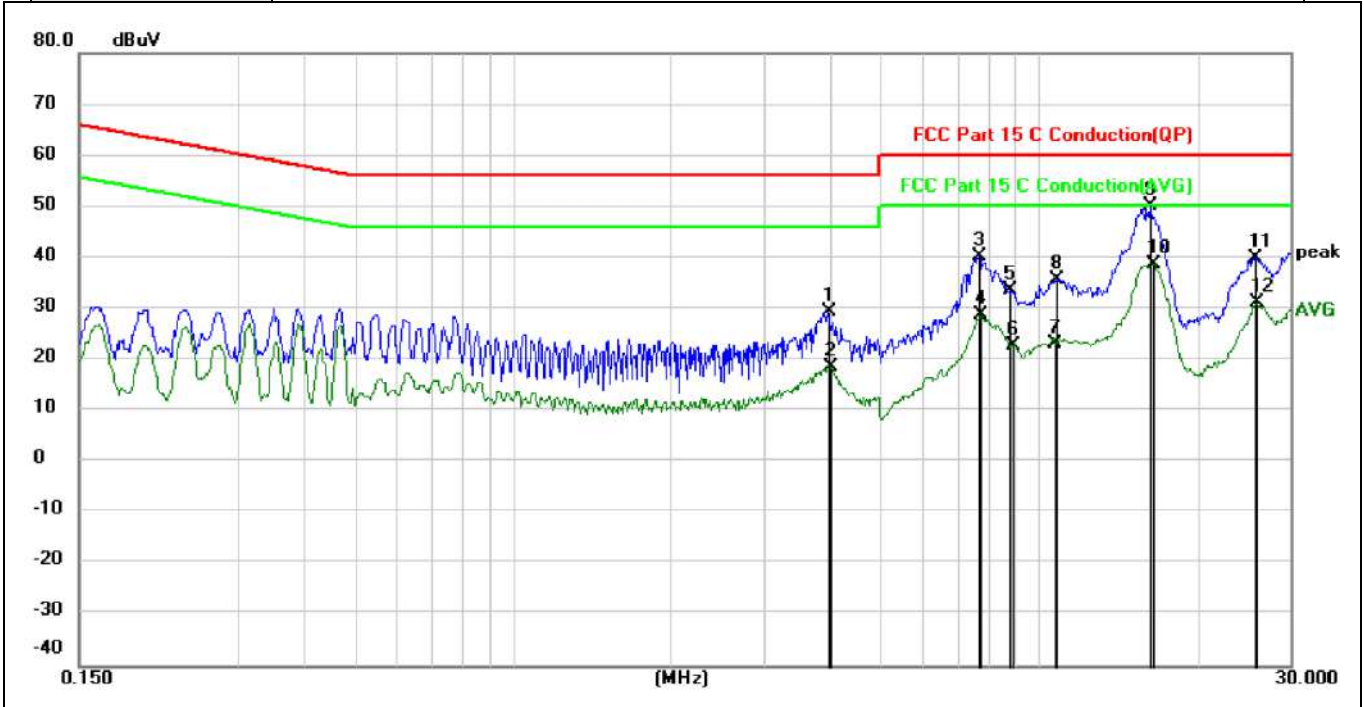

Remark: Factor = LISN factor + Cable Loss + Pulse limiter factor.

No.	Mk.	Freq. MHz	Reading Level dBuV	Correct Factor dB	Measure- ment dBuV	Limit dBuV	Over dB	Detector
1		3.9650	50.87	-21.28	29.59	56.00	-26.41	QP
2		4.0010	39.80	-21.28	18.52	46.00	-27.48	AVG
3		7.6750	61.28	-21.13	40.15	60.00	-19.85	QP
4		7.7500	49.90	-21.12	28.78	50.00	-21.22	AVG
5		8.7500	54.75	-21.09	33.66	60.00	-26.34	QP
6		8.8750	44.01	-21.09	22.92	50.00	-27.08	AVG
7		10.7000	44.16	-21.03	23.13	50.00	-26.87	AVG
8		10.7750	56.91	-21.03	35.88	60.00	-24.12	QP
9	*	16.2500	70.93	-20.89	50.04	60.00	-9.96	QP
10		16.4000	59.52	-20.89	38.63	50.00	-11.37	AVG
11		25.7248	60.41	-20.35	40.06	60.00	-19.94	QP
12		25.8749	51.47	-20.34	31.13	50.00	-18.87	AVG

*Maximum Data

EUT:	DataVINE™ Mesh Card	Model Name. :	DEC-O-A-701-10
Temperature:	24 °C	Relative Humidity:	50%
Pressure:	1010hPa	Test Date :	2022-02-09
Test Mode:	TX (11Mbps) CH1 (worst case)	Phase :	Negative
Test Voltage :	DC 12V		

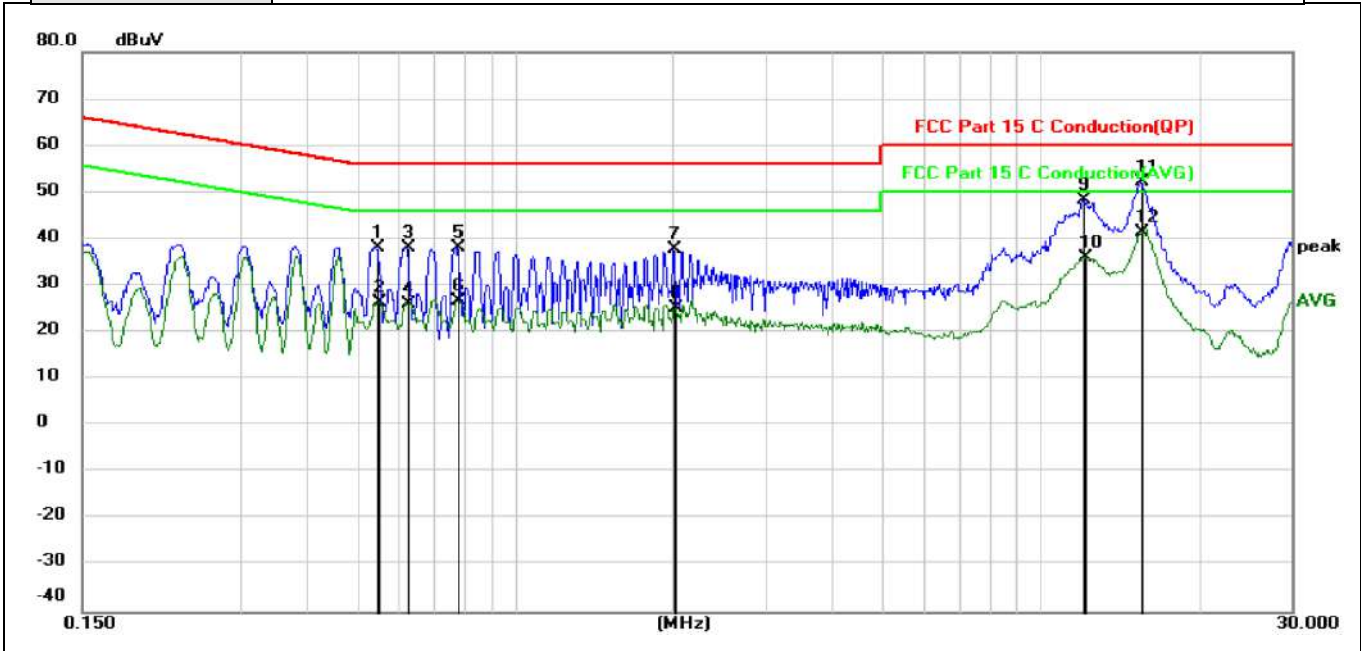

Remark: Factor = LISN factor + Cable Loss + Pulse limiter factor.

No.	Mk.	Freq. MHz	Reading Level dBuV	Correct Factor dB	Measure- ment dBuV	Limit dBuV	Over dB	Detector
1		0.5449	59.37	-21.18	38.19	56.00	-17.81	QP
2		0.5494	47.53	-21.18	26.35	46.00	-19.65	AVG
3		0.6258	59.31	-21.20	38.11	56.00	-17.89	QP
4		0.6258	47.36	-21.20	26.16	46.00	-19.84	AVG
5		0.7789	59.41	-21.26	38.15	56.00	-17.85	QP
6		0.7789	48.08	-21.26	26.82	46.00	-19.18	AVG
7		2.0029	59.33	-21.42	37.91	56.00	-18.09	QP
8		2.0119	46.56	-21.42	25.14	46.00	-20.86	AVG
9		12.0000	69.26	-20.99	48.27	60.00	-11.73	QP
10		12.1750	57.04	-20.99	36.05	50.00	-13.95	AVG
11	*	15.4750	73.04	-20.90	52.14	60.00	-7.86	QP
12		15.5750	62.45	-20.90	41.55	50.00	-8.45	AVG

*Maximum

Report No.: AAEMT/EMC/220208-01-02

EUT:	DataVINE™ Mesh Card	Model Name. :	DEC-O-A-701-10
Temperature:	24 °C	Relative Humidity:	50%
Pressure:	1010hPa	Test Date :	2022-03-03
Test Mode:	TX (11Mbps) CH1 (worst case)	Phase :	Positive
Test Voltage :	DC 4V		

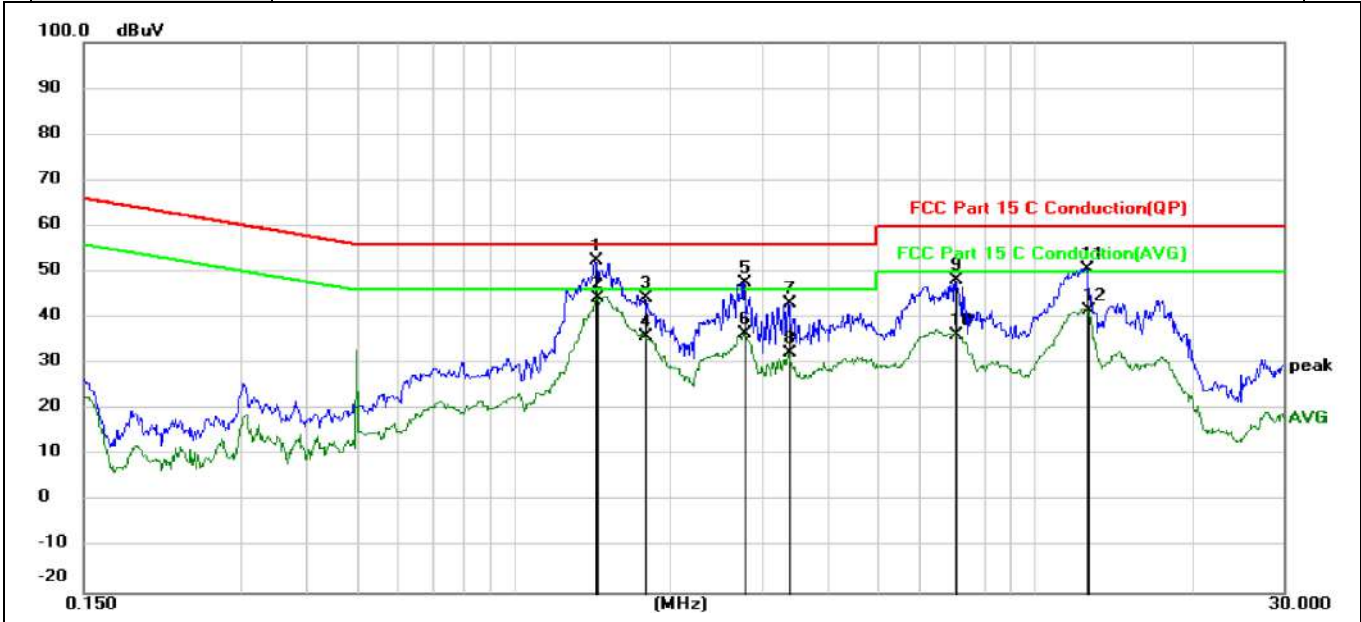

Remark: Factor = LISN factor + Cable Loss + Pulse limiter factor.

No.	Mk.	Freq. MHz	Reading Level dBuV	Correct Factor dB	Measure- ment dBuV	Limit dBuV	Over dB	Detector
1		1.4357	51.79	0.63	52.42	56.00	-3.58	QP
2	*	1.4449	43.57	0.63	44.20	46.00	-1.80	AVG
3		1.7822	43.88	0.60	44.48	56.00	-11.52	QP
4		1.7822	35.36	0.60	35.96	46.00	-10.04	AVG
5		2.7678	46.98	0.64	47.62	56.00	-8.38	QP
6		2.7678	36.02	0.64	36.66	46.00	-9.34	AVG
7		3.3664	42.41	0.68	43.09	56.00	-12.91	QP
8		3.3664	31.53	0.68	32.21	46.00	-13.79	AVG
9		7.0250	47.46	0.77	48.23	60.00	-11.77	QP
10		7.0499	35.62	0.77	36.39	50.00	-13.61	AVG
11		12.5998	50.00	0.72	50.72	60.00	-9.28	QP
12		12.6500	41.06	0.72	41.78	50.00	-8.22	AVG

*Maximum Data

Report No.: AAEMT/EMC/220208-01-02

EUT:	DataVINE™ Mesh Card	Model Name. :	DEC-O-A-701-10
Temperature:	24 °C	Relative Humidity:	50%
Pressure:	1010hPa	Test Date :	2022-03-03
Test Mode:	TX (11Mbps) CH1 (worst case)	Phase :	Negative
Test Voltage :	DC 4V		

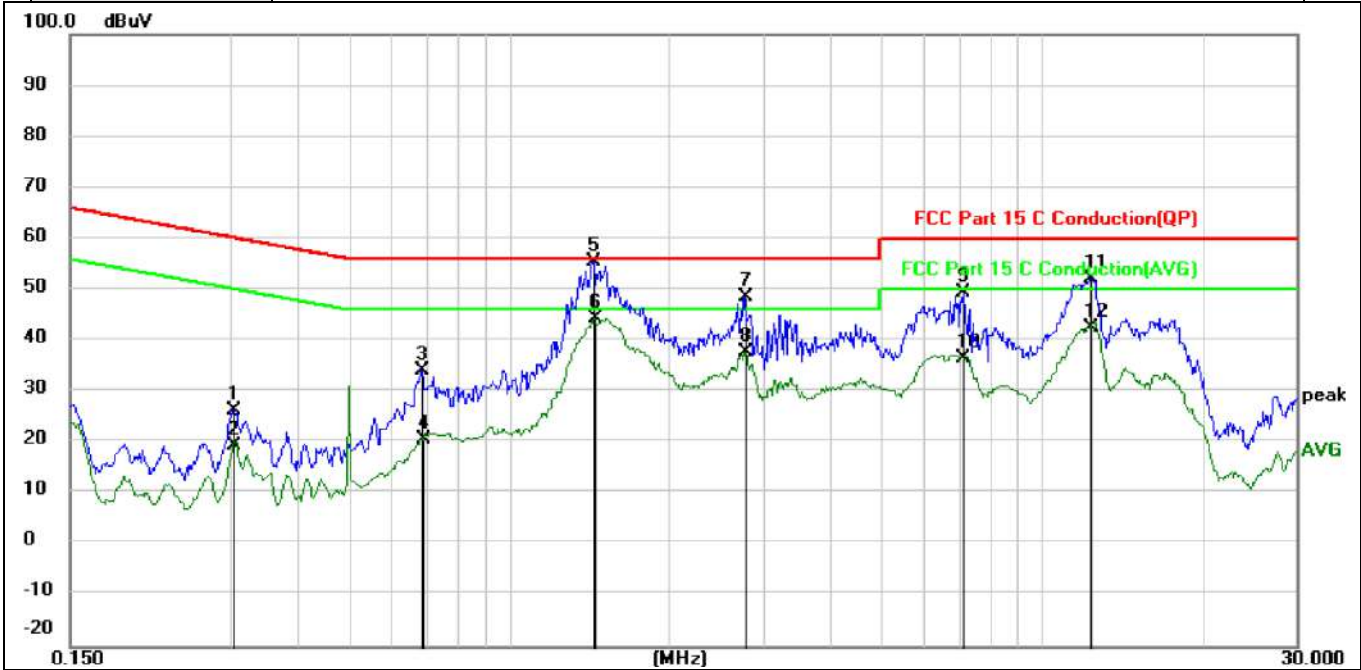

Remark: Factor = LISN factor + Cable Loss + Pulse limiter factor.

No.	Mk.	Freq. MHz	Reading Level dBuV	Correct Factor dB	Measure- ment dBuV	Limit dBuV	Over dB	Detector
1		0.3036	25.43	1.05	26.48	60.14	-33.66	QP
2		0.3036	18.39	1.05	19.44	50.14	-30.70	AVG
3		0.6844	33.36	0.78	34.14	56.00	-21.86	QP
4		0.6889	19.97	0.77	20.74	46.00	-25.26	AVG
5	*	1.4359	54.70	0.63	55.33	56.00	-0.67	QP
6		1.4449	43.60	0.63	44.23	46.00	-1.77	AVG
7		2.7680	47.86	0.64	48.50	56.00	-7.50	QP
8		2.7680	37.22	0.64	37.86	46.00	-8.14	AVG
9		7.1000	48.79	0.77	49.56	60.00	-10.44	QP
10		7.1000	35.87	0.77	36.64	50.00	-13.36	AVG
11		12.3250	51.57	0.72	52.29	60.00	-7.71	QP
12		12.3250	41.72	0.72	42.44	50.00	-7.56	AVG

*Maximum Data

7.4 Radiated Emissions Measurement

Test Requirement:	FCC Part 15 C section 15.247 (d) In any 100 kHz bandwidth outside the frequency band in which the spread spectrum or digitally modulated intentional radiator is operating. The radio frequency power that is produced by the intentional radiator shall be at least 20 dB below that in the 100 kHz bandwidth within the band that contains the highest level of the desired power, based on either an RF conducted or a radiated measurement, and provided the transmitter demonstrates compliance with the peak conducted power limits.
Test Method:	ANSI C63.10: Clause 6.4, 6.5 and 6.6
Test Status:	Pre-Scan has been conducted to determine the worst-case mode from all possible combinations between available modulations, data rates and antenna ports (if EUT with antenna diversity architecture). Following channel(s) was (were) selected for the final test as listed below. Pre-Test the EUT using external Standard DC power source for powering on the board.
Detector:	For PK value: RBW = 1 MHz for $f \geq 1$ GHz, 100 kHz for $f < 1$ GHz VBW \geq RBW Sweep = auto Detector function = peak Trace = max hold For AV value: RBW = 1 MHz for $f \geq 1$ GHz, 100 kHz for $f < 1$ GHz VBW = 10Hz Sweep = auto Detector function = peak Trace = max hold
15.209 Limit:	40.0 dB μ V/m between 30MHz & 88MHz 43.5 dB μ V/m between 88MHz & 216MHz 46.0 dB μ V/m between 216MHz & 960MHz 54.0 dB μ V/m above 960MHz

Test Configuration:

- 1) 9 kHz to 30 MHz emissions:

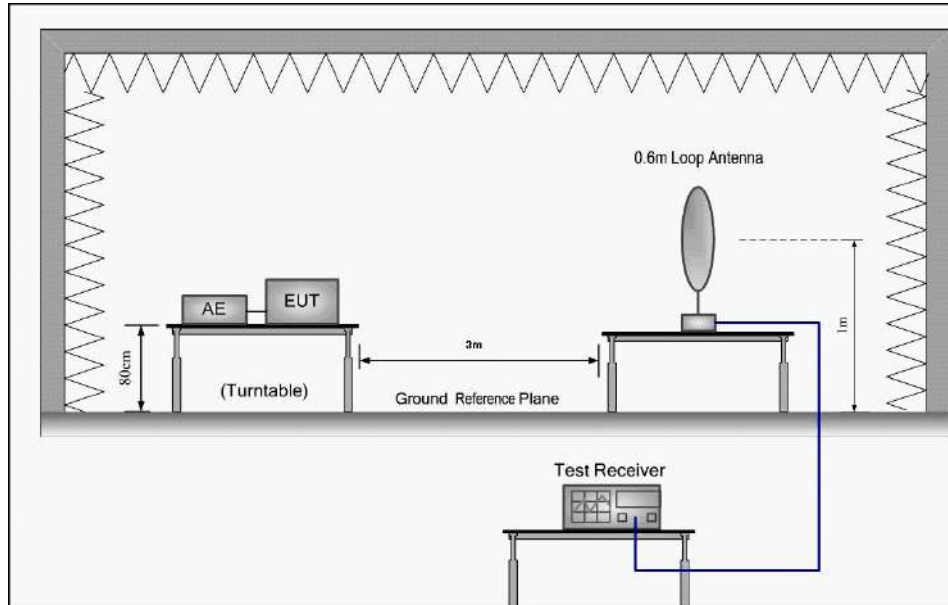

- 2) 30 MHz to 1 GHz emissions:

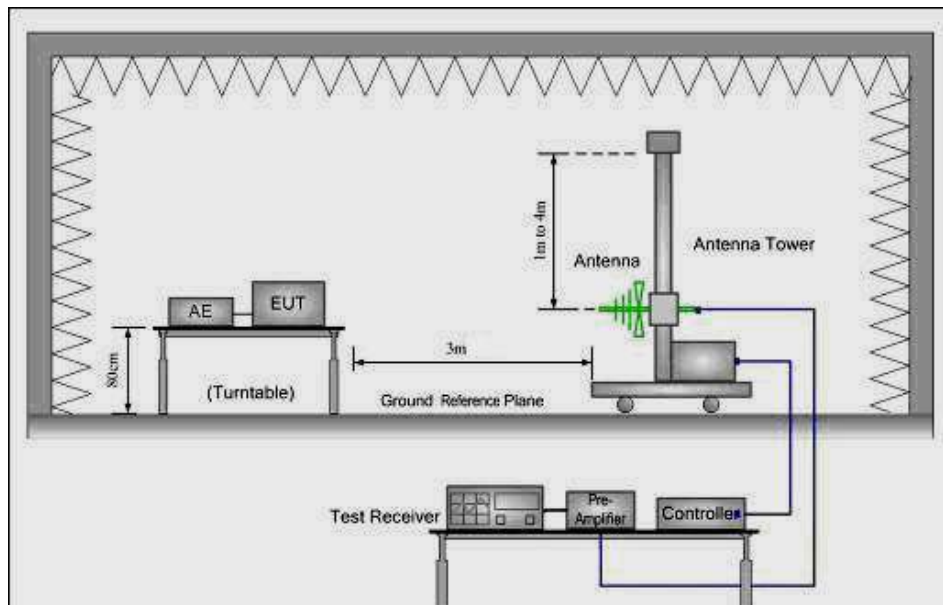

3) 1 GHz to 40 GHz emissions:

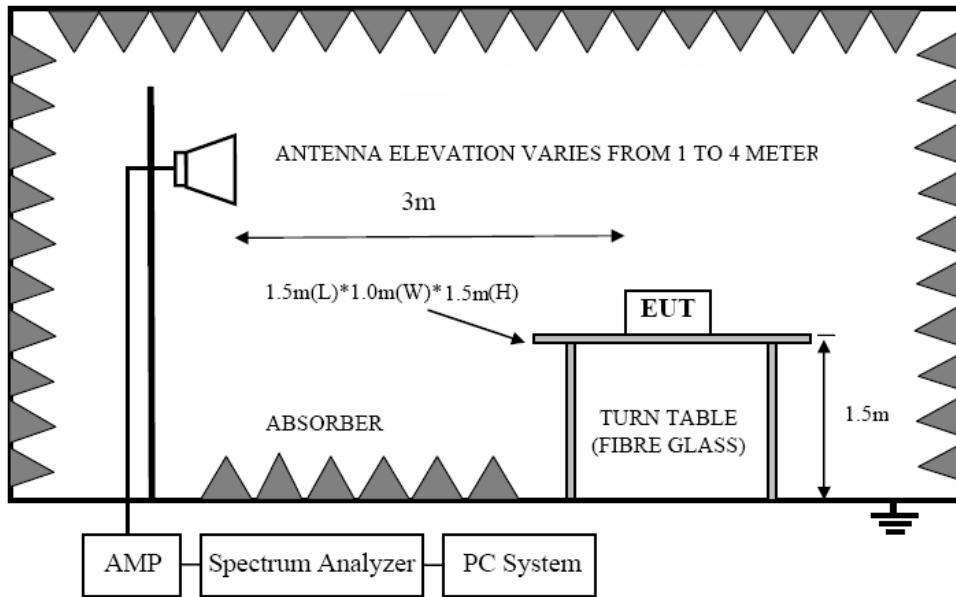

Test procedure:

Test site with RF absorbing material covering the ground plane that met the site validation criterion called out in CISPR 16-1-4:2007 was used to perform radiated emission test above 1 GHz.

The receiver was scanned from 30MHz to 25GHz. When an emission was found, the table was rotated to produce the maximum signal strength. An initial pre-scan was performed for in peak detection mode using the receiver. The EUT was measured for both the Horizontal and Vertical polarities and performed a pre-test three orthogonal planes. For intentional radiators, measurements of the variation of the input power or the radiated signal level of the fundamental frequency component of the emission, as appropriate, shall be performed with the supply voltage varied between 85% and 115% of the nominal rated supply voltage. The worst case emissions were reported.

From 30MHz to 1GHz, read the Quasi-Peak field strength of the emissions with receiver QP detector RBW=120KHz.

Above 1GHz, read the Peak field strength and Average field strength.

Read the Peak field strength through RBW=1MHz, VBW=3MHz in spectrum analyzer setting;

Read the Average field strength through RBW=1MHz, VBW=10Hz in spectrum analyzer setting;

For measurement at frequency above 1GHz

Place the measurement antenna away from each area of the EUT determined to be a source of emissions at the specified measurement distance, while keeping the measurement antenna aimed at the source of emissions at each frequency of significant emissions, with polarization oriented for maximum response. The measurement antenna may have to be higher or lower than the EUT, depending on the radiation pattern of the emission and staying aimed at the emission source for receiving the maximum signal. The final measurement antenna elevation shall be that which maximizes the emissions. The measurement antenna elevation for maximum emissions shall be restricted to a range of heights of from 1 m to 4 m above the ground or reference ground plane.

While maintaining all of the other instrument settings. This peak level, once corrected, must comply with the limit specified in Section 15.209. If the dwell time per channel of the hopping signal is less than 100 ms, then the average field strength reading obtained with the 10 Hz VBW may be further adjusted by a "duty cycle correction factor", derived from $20\log(\text{dwell time}/100 \text{ ms})$, in an effort to demonstrate compliance with the 15.209 limit.

7.4.1 Test Result

7.4.1.1 Radiated Emissions Test Data below 30MHz

EUT:	DataVINE™ Mesh Card	Model Name. :	DEC-O-A-701-10
Temperature:	23 °C	Test Data	2022-02-08
Pressure:	1005 hPa	Relative Humidity:	58%
Test Mode :	TX	Test Voltage :	DC 12V & DC 4V
Measurement Distance	3 m	Frequency Range	9KHz to 30MHz
RBW/VBW	9KHz~150KHz/RB 200Hz for QP, 150KHz~30MHz/RB 9KHz for QP		

No emission found between lowest internal used/generated frequencies to 30MHz.

7.4.1.2 Radiated Emissions Test Data 30MHz-1000MHz

EUT:	Data VINE™ Mesh Card	Model Name. :	DEC-O-A-701-10
Temperature:	26 °C	Test Data	2022-02-08
Pressure:	1010 hPa	Relative Humidity:	58%
Test Mode :	TX:802.11b 2.412 GHz(worst-case)	Test Voltage :	DC 12V
Measurement Distance	3 m	Frequency Range	30MHz to 1GHz
RBW/VBW	100KHz / 300KHz for spectrum, RBW=120KHz for receiver.		

Test at Channel 1 (2.412 GHz) in transmitting status (Worst Case)

30 MHz~1 GHz Spurious Emissions .Quasi-Peak Measurement

Vertical:

Peak scan

Level (dB μ V/m)

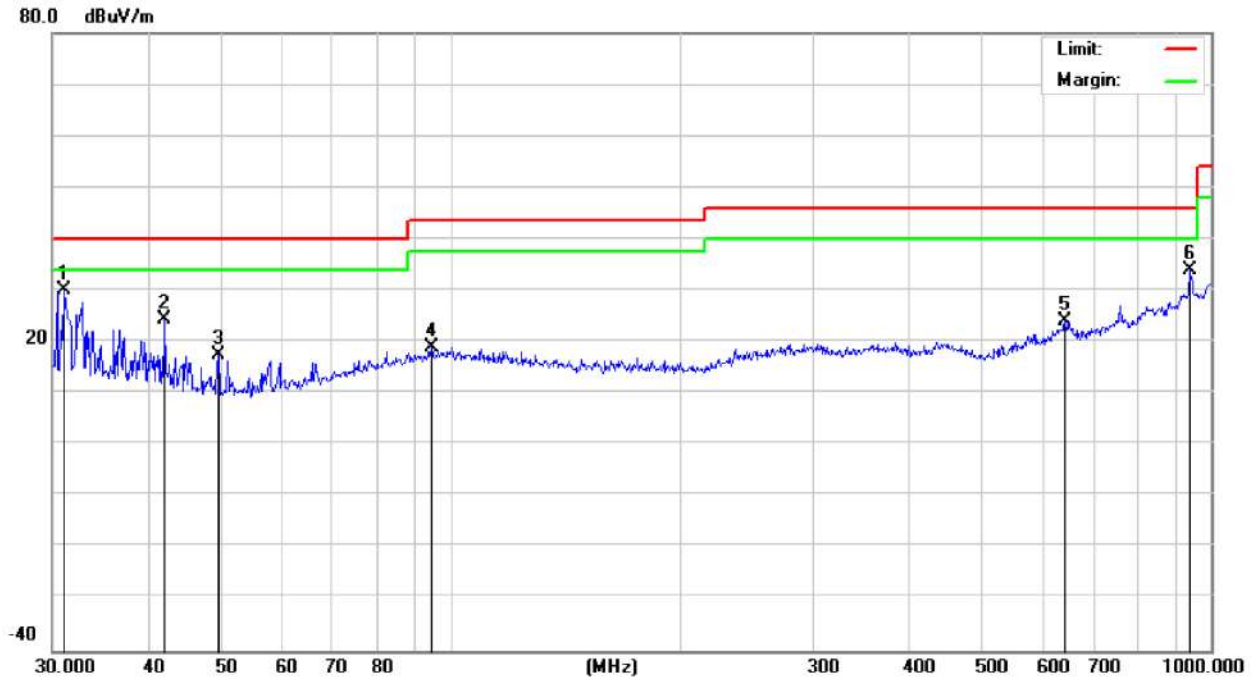

Quasi-peak measurement

No.	Mk.	Freq. MHz	Reading Level dB μ V	Correct Factor dB	Measure- ment dB μ V/m	Limit dB/m	Over dB	Detector
1	*	31.0706	33.36	-3.36	30.00	40.00	-10.00	QP
2		42.1542	34.90	-10.57	24.33	40.00	-15.67	QP
3		49.5328	25.71	-8.36	17.35	40.00	-22.65	QP
4		94.4284	22.20	-3.20	19.00	43.50	-24.50	QP
5		642.8613	22.27	1.66	23.93	46.00	-22.07	QP
6		938.8326	23.69	10.12	33.81	46.00	-12.19	QP

*Maximum Data

Horizontal:

Peak scan

Level (dB μ V/m)

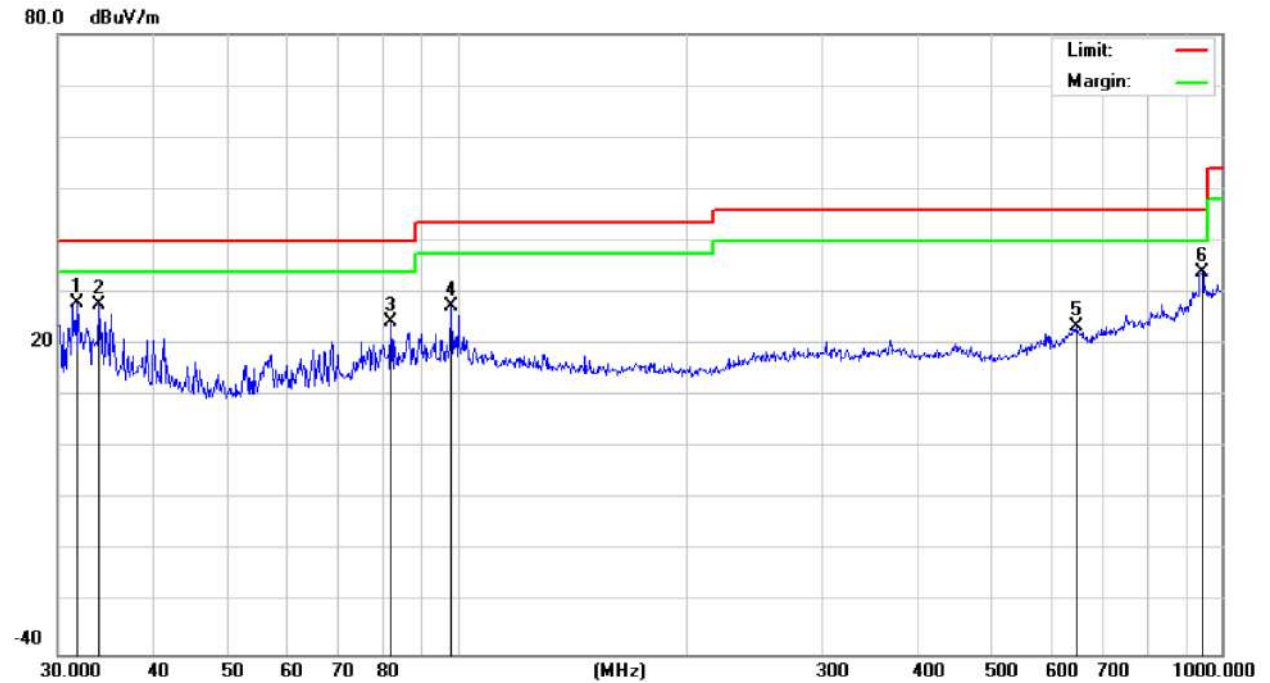

Quasi-peak measurement

No.	Mk.	Freq. MHz	Reading Level dB μ V	Correct Factor dB	Measure- ment dB μ V/m	Limit dB/m	Over dB	Detector
1		31.8427	31.90	-4.04	27.86	40.00	-12.14	QP
2		33.9174	33.48	-5.87	27.61	40.00	-12.39	QP
3		81.7833	30.13	-5.83	24.30	40.00	-15.70	QP
4		98.1419	29.28	-1.93	27.35	43.50	-16.15	QP
5		645.1195	21.82	1.68	23.50	46.00	-22.50	QP
6	*	942.1305	23.76	10.27	34.03	46.00	-11.97	QP

*Maximum Data

EUT:	DataVINE™ Mesh Card	Model Name. :	DEC-O-A-701-10
Temperature:	26 °C	Test Data	2022-02-08
Pressure:	1010 hPa	Relative Humidity:	58%
Test Mode :	TX:802.11b 2.412 GHz(worst-case)	Test Voltage :	DC 4V
Measurement Distance	3 m	Frequency Range	30MHz to 1GHz
RBW/VBW	100KHz / 300KHz for spectrum, RBW=120KHz for receiver.		

Test at Channel 1 (2.412 GHz) in transmitting status (Worst Case)

30 MHz~1 GHz Spurious Emissions .Quasi-Peak Measurement

Vertical:

Peak scan

Level (dBμV/m)

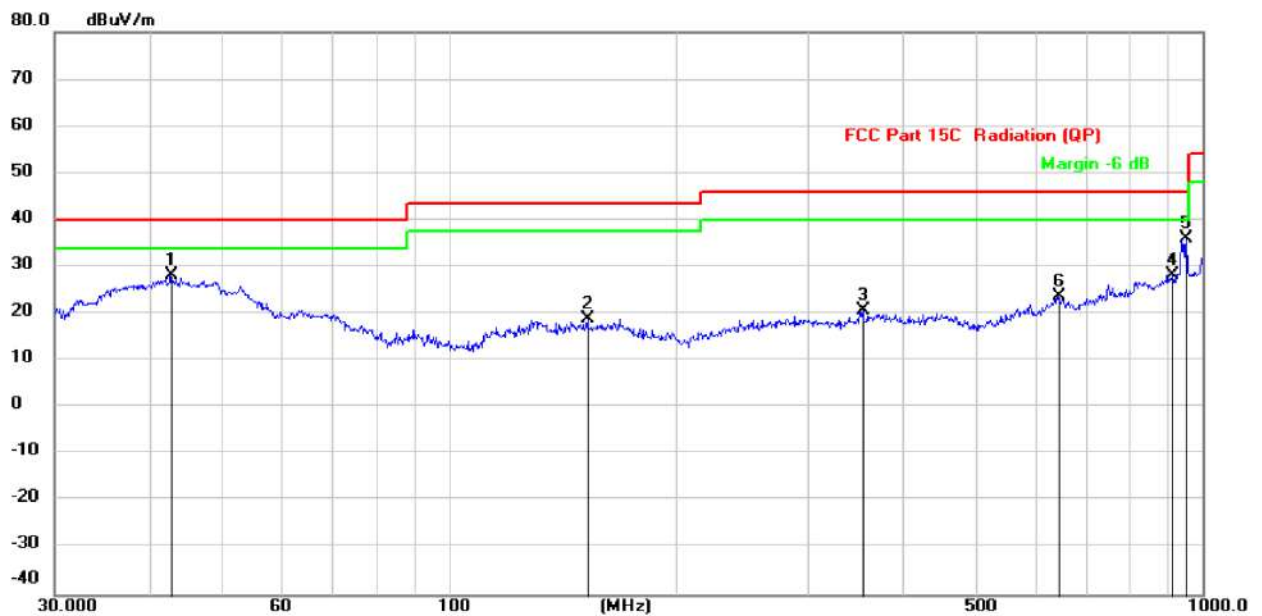

No.	Mk.	Freq. MHz	Reading Level dBuV	Correct Factor dB	Measure- ment dBuV/m	Limit dBuV/m	Over dB	Detector
1		42.7496	38.63	-10.34	28.29	40.00	-11.71	QP
2		152.6641	21.11	-2.20	18.91	43.50	-24.59	QP
3		354.1831	22.20	-1.35	20.85	46.00	-25.15	QP
4		912.8620	19.83	8.42	28.25	46.00	-17.75	QP
5	*	952.0937	25.81	10.24	36.05	46.00	-9.95	QP
6		642.8613	21.88	1.96	23.84	46.00	-22.16	QP

*Maximum Data

Horizontal:

Peak scan

Level (dB μ V/m)

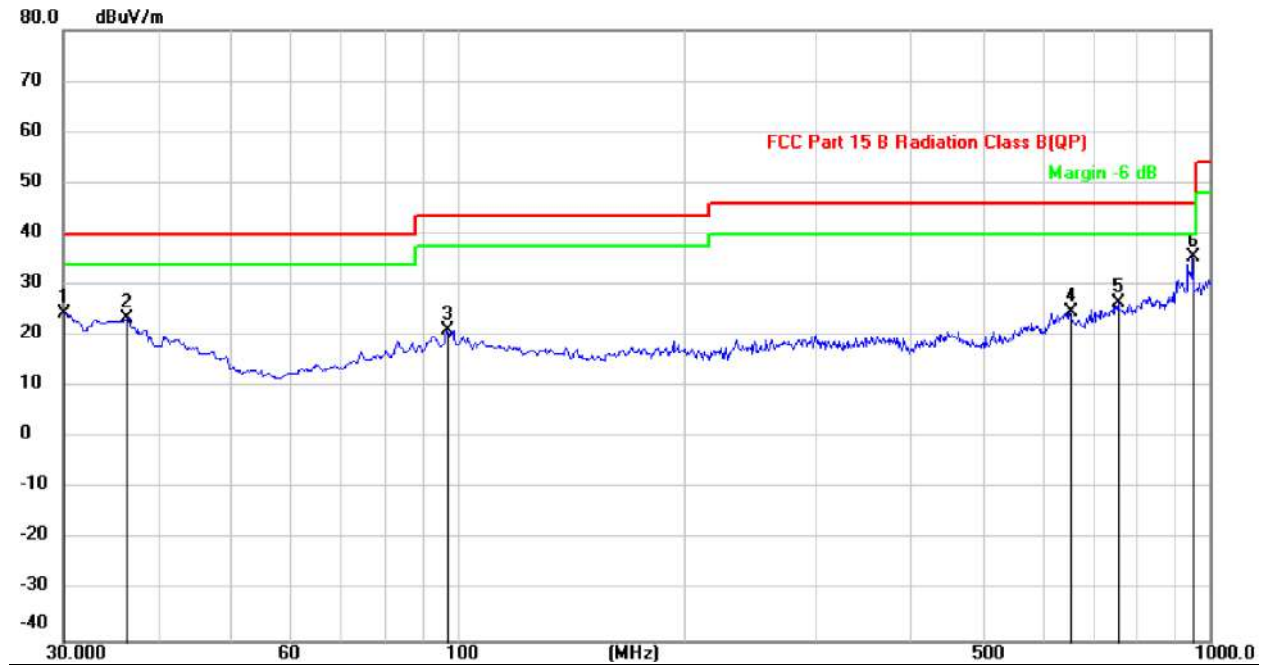

No.	Mk.	Freq. MHz	Reading Level dBuV	Correct Factor dB	Measure- ment dBuV/m	Limit dBuV/m	Over dB	Detector
1		30.0000	26.77	-2.42	24.35	40.00	-15.65	QP
2		36.3814	31.61	-8.04	23.57	40.00	-16.43	QP
3		96.9300	23.34	-2.34	21.00	43.50	-22.50	QP
4		652.7400	22.79	1.73	24.52	46.00	-21.48	QP
5		757.5000	23.33	3.07	26.40	46.00	-19.60	QP
6	*	950.5300	25.25	10.25	35.50	46.00	-10.50	QP

*Maximum Data

7.4.1.3 Radiated Emissions Test Data above 1GHz

802.11b mode with 11Mbps data rate

EUT:	Data VINE™ Mesh Card	Model Name. :	DEC-O-A-701-10
Temperature:	26 °C	Test Data	2022-02-08
Pressure:	1010 hPa	Relative Humidity:	58%
Test Mode :	TX:802.11b 2.412 GHz (worst-case)	Test Voltage :	DC 12V
Measurement Distance	3 m	Frequency Range	1GHz to 18GHz
RBW/VBW	100KHz / 300KHz for spectrum, RBW=120KHz for receiver.		

Test at Channel 1 (2.412 GHz) in transmitting status (Worst Case)

1000 MHz~18000 GHz Spurious Emissions .Quasi-Peak Measurement

Vertical:

Peak scan

Level (dBμV/m)

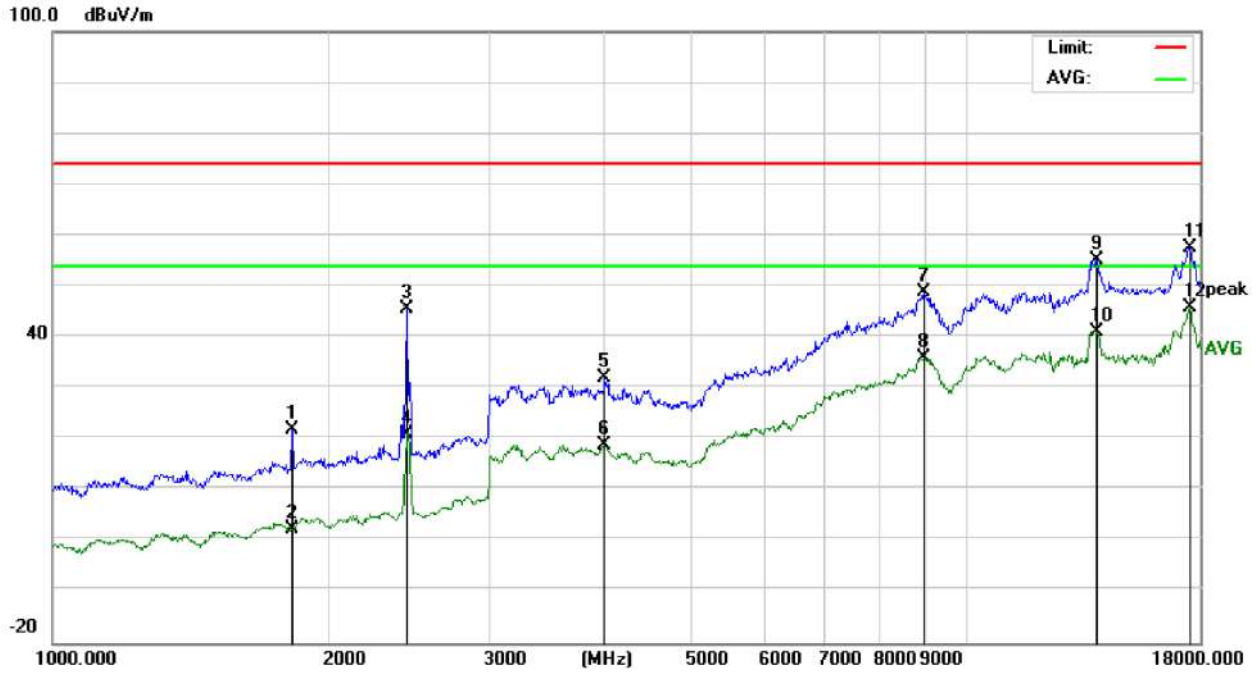

No.	Mk.	Freq. MHz	Reading Level dBuV	Correct Factor dB	Measure- ment dBuV/m	Limit dB/m	Over dB	Detector
1		1824.302	32.35	-10.52	21.83	74.00	-52.17	peak
2		1829.582	12.96	-10.49	2.47	54.00	-51.53	AVG
3		2435.701	53.15	-7.59	45.56	74.00	-28.44	peak
4		2442.751	28.45	-7.57	20.88	54.00	-33.12	AVG
5		4015.929	35.51	-3.53	31.98	74.00	-42.02	peak
6		4015.929	22.30	-3.53	18.77	54.00	-35.23	AVG
7		8969.161	34.60	14.27	48.87	74.00	-25.13	peak
8		8969.161	21.67	14.27	35.94	54.00	-18.06	AVG
9		13877.07	37.78	17.38	55.16	74.00	-18.84	peak
10		13877.07	23.55	17.38	40.93	54.00	-13.07	AVG
11		17537.79	37.55	19.88	57.43	74.00	-16.57	peak
12	*	17537.79	25.92	19.88	45.80	54.00	-8.20	AVG

*Maximum Data

Note: Marker 3 is intentional frequency from the EUT, hence considered as PASS.

Horizontal:

Peak scan

Level (dBµV/m)

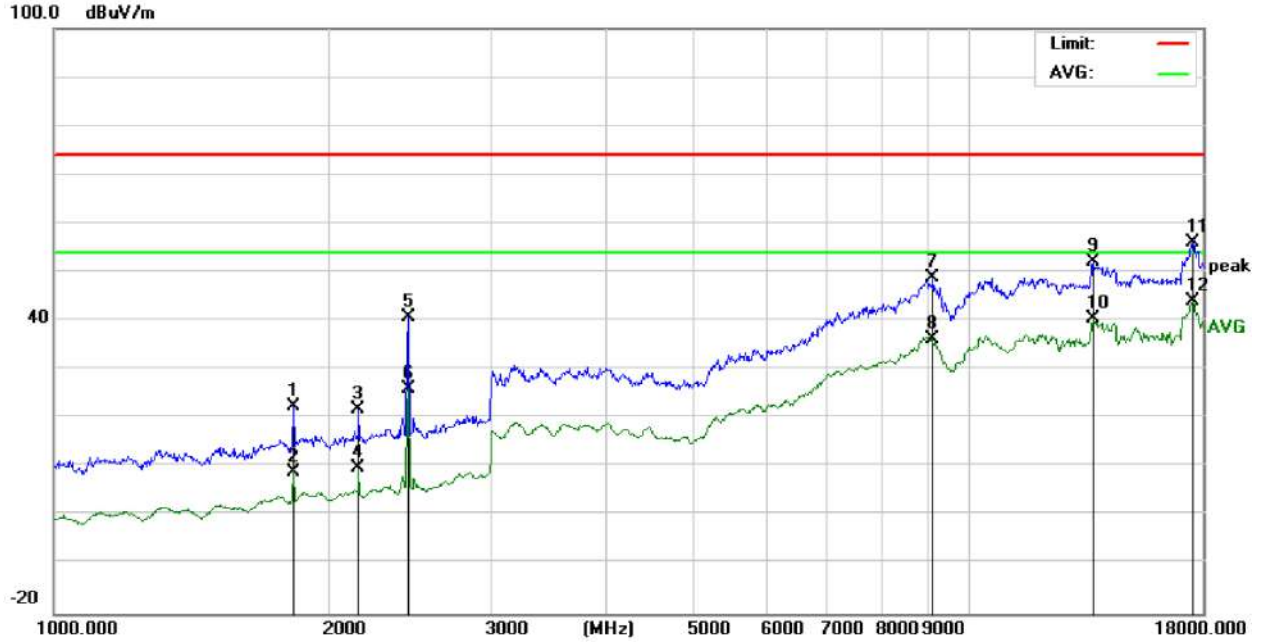

No.	Mk.	Freq. MHz	Reading Level dBµV	Correct Factor dB	Measure- ment dBµV/m	Limit dB/m	Over dB	Detector
1		1829.582	32.80	-10.49	22.31	74.00	-51.69	peak
2		1829.582	19.59	-10.49	9.10	54.00	-44.90	AVG
3		2151.034	30.78	-8.85	21.93	74.00	-52.07	peak
4		2151.034	18.79	-8.85	9.94	54.00	-44.06	AVG
5		2435.701	48.23	-7.59	40.64	74.00	-33.36	peak
6		2442.751	33.62	-7.57	26.05	54.00	-27.95	AVG
7		9126.063	36.13	12.76	48.89	74.00	-25.11	peak
8		9126.063	23.39	12.76	36.15	54.00	-17.85	AVG
9		13638.49	35.05	17.22	52.27	74.00	-21.73	peak
10		13677.96	23.17	17.24	40.41	54.00	-13.59	AVG
11		17537.79	36.06	19.88	55.94	74.00	-18.06	peak
12	*	17537.79	24.24	19.88	44.12	54.00	-9.88	AVG

*Maximum Data

Note: Marker 5 is intentional frequency from the EUT, hence considered as PASS.

Report No.: AAEMT/EMC/220208-01-02

EUT:	Data VINE™ Mesh Card	Model Name. :	DEC-O-A-701-10
Temperature:	26 °C	Test Data	2022-03-03
Pressure:	1010 hPa	Relative Humidity:	58%
Test Mode :	TX:802.11b 2.412 GHz (worst-case)	Test Voltage :	DC 4V
Measurement Distance	3 m	Frequency Range	1GHz to 18GHz
RBW/VBW	100KHz / 300KHz for spectrum, RBW=120KHz for receiver.		

Test at Channel 1 (2.412 GHz) in transmitting status (Worst Case)

1000 MHz~18000 GHz Spurious Emissions .Quasi-Peak Measurement

Vertical:

Peak scan

Level (dBµV/m)

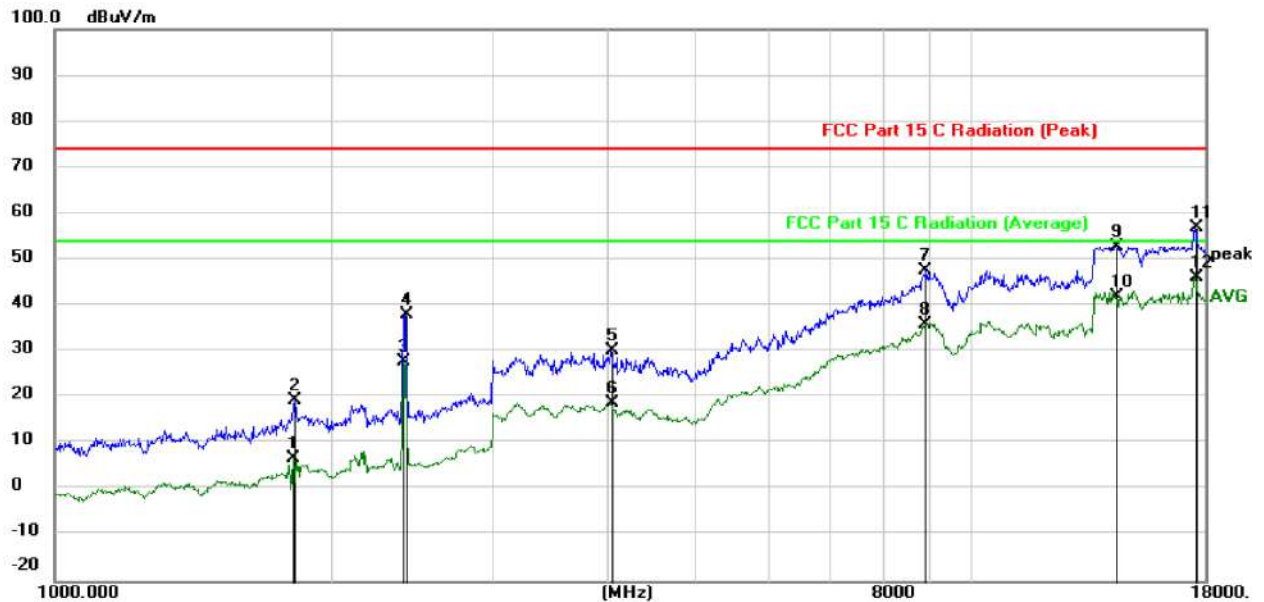

No.	Mk.	Freq. MHz	Reading Level dBµV	Correct Factor dB	Measure- ment dBµV/m	Limit dBµV/m	Over dB	Detector
1		1819.036	17.37	-10.54	6.83	54.00	-47.17	AVG
2		1829.582	30.00	-10.49	19.51	74.00	-54.49	peak
3		2400.753	35.46	-7.75	27.71	54.00	-26.29	AVG
4		2414.672	45.82	-7.69	38.13	74.00	-35.87	peak
5		4039.212	33.83	-3.58	30.25	74.00	-43.75	peak
6		4039.212	22.35	-3.58	18.77	54.00	-35.23	AVG
7		8917.462	33.94	13.86	47.80	74.00	-26.20	peak
8		8917.462	22.05	13.86	35.91	54.00	-18.09	AVG
9		14366.84	37.12	15.66	52.78	74.00	-21.22	peak
10		14366.84	26.25	15.66	41.91	54.00	-12.09	AVG
11		17537.79	37.20	19.88	57.08	74.00	-16.92	peak
12	*	17537.79	26.15	19.88	46.03	54.00	-7.97	AVG

*Maximum Data

Note: Marker 4 is intentional frequency from the EUT, hence considered as PASS.

Horizontal:

Peak scan

Level (dBuV/m)

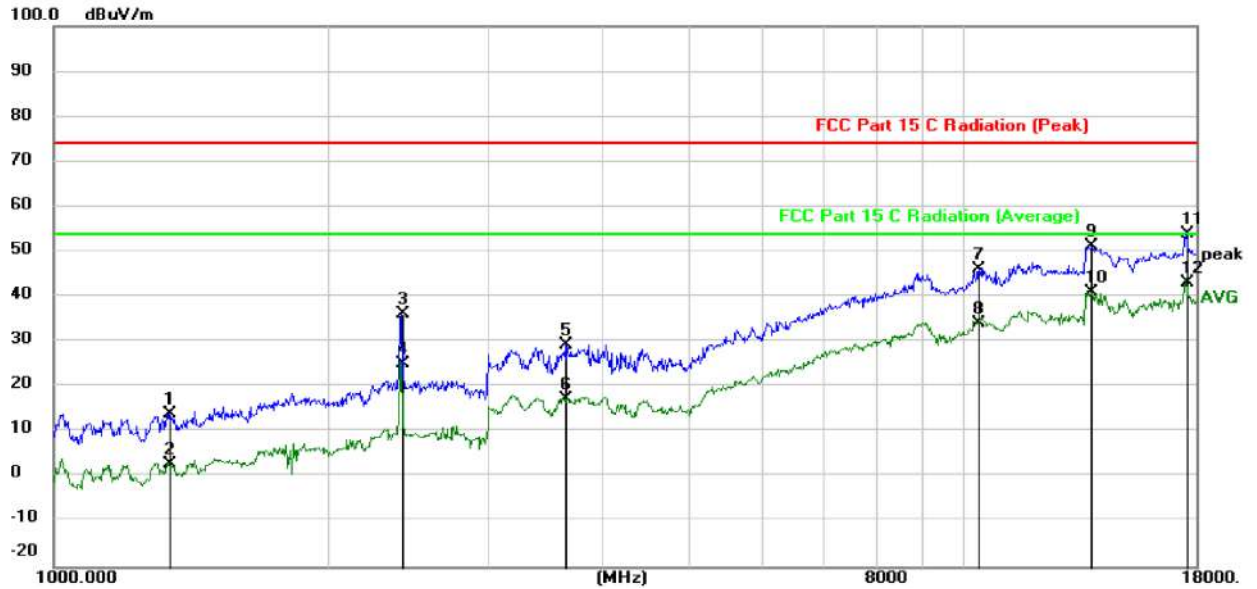

No.	Mk.	Freq. MHz	Reading Level dBuV	Correct Factor dB	Measure- ment dBuV/m	Limit dBuV/m	Over dB	Detector
1		1339.006	27.39	-13.23	14.16	74.00	-59.84	peak
2		1339.006	16.16	-13.23	2.93	54.00	-51.07	AVG
3		2414.672	43.82	-7.69	36.13	74.00	-37.87	peak
4		2414.672	32.85	-7.69	25.16	54.00	-28.84	AVG
5		3661.148	33.65	-4.15	29.50	74.00	-44.50	peak
6		3661.148	21.51	-4.15	17.36	54.00	-36.64	AVG
7		10393.71	33.11	13.15	46.26	74.00	-27.74	peak
8		10393.71	21.13	13.15	34.28	54.00	-19.72	AVG
9		13837.02	33.90	17.35	51.25	74.00	-22.75	peak
10		13837.02	23.67	17.35	41.02	54.00	-12.98	AVG
11		17537.79	34.20	19.88	54.08	74.00	-19.92	peak
12	*	17537.79	23.15	19.88	43.03	54.00	-10.97	AVG

*Maximum Data

Note: Marker 3 is intentional frequency from the EUT, hence considered as PASS.

The field strength is calculated by adding the Antenna Factor. Cable Factor & Preamplifier. The basic equation with a sample calculation is as follows:

Final Test Level = Receiver Reading + Antenna Factor + Cable Loss – Preamplifier Factor.

As shown in Section, for frequencies above 1000 MHz. the above field strength limits are based on average limits. However, the peak field strength of any emission shall not exceed the maximum permitted average limits specified above by more than 20 dB under any condition of modulation.

No any other emissions level which are attenuated less than 20dB below the limit.

According to 15.31(o), The amplitude of spurious emissions from intentional radiators and emissions from unintentional radiators which are attenuated more than 20 dB below the permissible value need not be reported unless specifically required elsewhere in this Part.

Hence there no other emissions have been reported.

Remark:

- 1) .For this intentional radiator operates below 25 GHz. The spectrum shall be investigated to the tenth harmonics of the highest fundamental frequency. And above the third harmonic of this intentional radiator, the disturbance is very low. So the test result only displays to 3rd harmonic.
- 2). As shown in Section, for frequencies above 1000 MHz. the above field strength limits are based on average limits. However, the peak field strength of any emission shall not exceed the maximum permitted average limits specified above by more than 20 dB under any condition of modulation.
- 3). The test only perform the EUT in transmitting status since the test frequencies were over 1GHz only required transmitting status.

Test result: The unit does meet the FCC requirements.

7.4.2 Radiated Emissions which fall in the restricted bands

Test Requirement:	FCC Part 15 C section 15.247 (d) In addition, radiated emissions which fall in the restricted bands, as defined in Section 15.205(a), must also comply with the radiated emission limits specified in Section 15.209(a) (see Section 15.205(c)).
Test Method:	ANSI C63.10: Clause 6.4, 6.5 and 6.6
Test Status:	Pre-Scan has been conducted to determine the worst-case mode from all possible combinations between available modulations, data rates and antenna ports (if EUT with antenna diversity architecture). Following channel(s) was (were) selected for the final test as listed below. Pre-Test the EUT using external Standard DC power source for powering on the board.
Test site:	Measurement Distance: 3m (Semi-Anechoic Chamber)
Limit:	40.0 dB μ V/m between 30MHz & 88MHz; 43.5 dB μ V/m between 88MHz & 216MHz; 46.0 dB μ V/m between 216MHz & 960MHz; 54.0 dB μ V/m above 960MHz.
Detector:	For PK value: RBW = 1 MHz for $f \geq 1$ GHz, 100 kHz for $f < 1$ GHz VBW \geq RBW Sweep = auto Detector function = peak Trace = max hold For AV value: RBW = 1 MHz for $f \geq 1$ GHz, 100 kHz for $f < 1$ GHz VBW = 10Hz Sweep = auto Detector function = peak Trace = max hold

Section 15.205 Restricted bands of operation.

(a) Except as shown in paragraph (d) of this section, only spurious emissions are permitted in any of the frequency bands listed below:

MHz	MHz	MHz	GHz
0.090 - 0.110	16.42 - 16.423	399.9 - 410	4.5 - 5.15
¹ 0.495 - 0.505	16.69475 - 16.69525	608 - 614	5.35 - 5.46
2.1735 - 2.1905	16.80425 - 16.80475	960 - 1240	7.25 - 7.75
4.125 - 4.128	25.5 - 25.67	1300 - 1427	8.025 - 8.5
4.17725 - 4.17775	37.5 - 38.25	1435 - 1626.5	9.0 - 9.2
4.20725 - 4.20775	73 - 74.6	1645.5 - 1646.5	9.3 - 9.5
6.215 - 6.218	74.8 - 75.2	1660 - 1710	10.6 - 12.7
6.26775 - 6.26825	108 - 121.94	1718.8 - 1722.2	13.25 - 13.4
6.31175 - 6.31225	123 - 138	2200 - 2300	14.47 - 14.5
8.291 - 8.294	149.9 - 150.05	2310 - 2390	15.35 - 16.2
8.362 - 8.366	156.52475 - 156.52525	2483.5 - 2500	17.7 - 21.4
8.37625 - 8.38675	156.7 - 156.9	2655 - 2900	22.01 - 23.12
8.41425 - 8.41475	162.0125 - 167.17	3260 - 3267	23.6 - 24.0
12.29 - 12.293	167.72 - 173.2	3332 - 3339	31.2 - 31.8
12.51975 - 12.52025	240 - 285	3345.8 - 3358	36.43 - 36.5
12.57675 - 12.57725	322 - 335.4	3600 - 4400	
13.36 - 13.41			

Test Result:

7.4.2.1 802.11b mode with 11Mbps data rate

Test at Channel 1 (2.412 GHz) in transmitting status

Peak Measurement:

Frequency (MHz)	Reading Level (dB μ V)	Antenna factors (dB/m)	Cable loss (dB)	Preamp factor (dB)	Emission Level (dB μ V/m)	Limit (dB μ V/m)	Antenna polarization
2310.000	55.09	27.93	4.74	35.09	52.67	74.00	Vertical
2390.000	55.90	27.63	4.96	35.05	53.44	74.00	V
2483.500	53.30	27.55	4.90	34.99	50.76	74.00	V
2500.000	53.61	27.55	5.00	34.98	51.18	74.00	V
2310.000	53.82	27.93	4.74	35.09	51.40	74.00	Horizontal
2390.000	52.72	27.63	4.96	35.05	50.26	74.00	H
2483.500	53.99	27.55	4.90	34.99	51.45	74.00	H
2500.000	52.56	27.55	5.00	34.98	50.13	74.00	H

Average Measurement:

Frequency (MHz)	Reading Level (dB μ V)	Antenna factors (dB/m)	Cable loss (dB)	Preamp factor (dB)	Emission Level (dB μ V/m)	Limit (dB μ V/m)	Antenna polarization
2310.000	43.40	27.93	4.74	35.09	40.98	54.00	Vertical
2390.000	42.80	27.63	4.96	35.05	40.34	54.00	V
2483.500	43.89	27.55	4.90	34.99	41.35	54.00	V
2500.000	43.21	27.55	5.00	34.98	40.78	54.00	V
2310.000	43.85	27.93	4.74	35.09	41.43	54.00	Horizontal
2390.000	42.83	27.63	4.96	35.05	40.37	54.00	H
2483.500	42.42	27.55	4.90	34.99	39.88	54.00	H
2500.000	45.00	27.55	5.00	34.98	42.57	54.00	H

Test at Channel 6 (2.437 GHz) in transmitting status

Peak Measurement:

Frequency (MHz)	Reading Level (dBμV)	Antenna factors (dB/m)	Cable loss (dB)	Preamp factor (dB)	Emission Level (dBμV/m)	Limit (dBμV/m)	Antenna polarization
2310.000	55.43	27.93	4.74	35.09	53.01	74.00	Vertical
2390.000	54.70	27.63	4.96	35.05	52.24	74.00	V
2483.500	53.93	27.55	4.90	34.99	51.39	74.00	V
2500.000	52.52	27.55	5.00	34.98	50.09	74.00	V
2310.000	55.31	27.93	4.74	35.09	52.89	74.00	Horizontal
2390.000	54.96	27.63	4.96	35.05	52.50	74.00	H
2483.500	53.29	27.55	4.90	34.99	50.75	74.00	H
2500.000	53.84	27.55	5.00	34.98	51.41	74.00	H

Average Measurement:

Frequency (MHz)	Reading Level (dBμV)	Antenna factors (dB/m)	Cable loss (dB)	Preamp factor (dB)	Emission Level (dBμV/m)	Limit (dBμV/m)	Antenna polarization
2310.000	42.37	27.93	4.74	35.09	39.95	54.00	Vertical
2390.000	43.96	27.63	4.96	35.05	41.50	54.00	V
2483.500	44.28	27.55	4.90	34.99	41.74	54.00	V
2500.000	43.29	27.55	5.00	34.98	40.86	54.00	V
2310.000	43.32	27.93	4.74	35.09	40.90	54.00	Horizontal
2390.000	43.89	27.63	4.96	35.05	41.43	54.00	H
2483.500	43.53	27.55	4.90	34.99	40.99	54.00	H
2500.000	42.74	27.55	5.00	34.98	40.31	54.00	H

Test at Channel 11 (2.462 GHz) in transmitting status

Peak Measurement:

Frequency (MHz)	Reading Level (dBμV)	Antenna factors (dB/m)	Cable loss (dB)	Preamp factor (dB)	Emission Level (dBμV/m)	Limit (dBμV/m)	Antenna polarization
2310.000	54.16	27.93	4.74	35.09	51.74	74.00	Vertical
2390.000	54.34	27.63	4.96	35.05	51.88	74.00	V
2483.500	55.49	27.55	4.90	34.99	52.95	74.00	V
2500.000	53.48	27.55	5.00	34.98	51.05	74.00	V
2310.000	54.20	27.93	4.74	35.09	51.78	74.00	Horizontal
2390.000	53.28	27.63	4.96	35.05	50.82	74.00	H
2483.500	52.59	27.55	4.90	34.99	50.05	74.00	H
2500.000	53.87	27.55	5.00	34.98	51.44	74.00	H

Average Measurement:

Frequency (MHz)	Reading Level (dBμV)	Antenna factors (dB/m)	Cable loss (dB)	Preamp factor (dB)	Emission Level (dBμV/m)	Limit (dBμV/m)	Antenna polarization
2310.000	44.14	27.93	4.74	35.09	41.72	54.00	Vertical
2390.000	41.45	27.63	4.96	35.05	38.99	54.00	V
2483.500	45.91	27.55	4.90	34.99	43.37	54.00	V
2500.000	44.21	27.55	5.00	34.98	41.78	54.00	V
2310.000	44.23	27.93	4.74	35.09	41.81	54.00	Horizontal
2390.000	43.82	27.63	4.96	35.05	41.36	54.00	H
2483.500	43.54	27.55	4.90	34.99	41.00	54.00	H
2500.000	44.58	27.55	5.00	34.98	42.15	54.00	H

7.4.2.2 802.11g mode with 54Mbps data rate

Test at Channel 1 (2.412 GHz) in transmitting status

Peak Measurement:

Frequency (MHz)	Reading Level (dBμV)	Antenna factors (dB/m)	Cable loss (dB)	Preamp factor (dB)	Emission Level (dBμV/m)	Limit (dBμV/m)	Antenna polarization
2310.000	55.46	27.93	4.74	35.09	53.04	74.00	Vertical
2390.000	54.37	27.63	4.96	35.05	51.91	74.00	V
2483.500	54.76	27.55	4.90	34.99	52.22	74.00	V
2500.000	54.71	27.55	5.00	34.98	52.28	74.00	V
2310.000	54.78	27.93	4.74	35.09	52.36	74.00	Horizontal
2390.000	53.40	27.63	4.96	35.05	50.94	74.00	H
2483.500	54.78	27.55	4.90	34.99	52.24	74.00	H
2500.000	54.65	27.55	5.00	34.98	52.22	74.00	H

Average Measurement:

Frequency (MHz)	Reading Level (dBμV)	Antenna factors (dB/m)	Cable loss (dB)	Preamp factor (dB)	Emission Level (dBμV/m)	Limit (dBμV/m)	Antenna polarization
2310.000	45.62	27.93	4.74	35.09	43.20	54.00	Vertical
2390.000	43.16	27.63	4.96	35.05	40.70	54.00	V
2483.500	42.89	27.55	4.90	34.99	40.35	54.00	V
2500.000	45.26	27.55	5.00	34.98	42.83	54.00	V
2310.000	44.33	27.93	4.74	35.09	41.91	54.00	Horizontal
2390.000	42.23	27.63	4.96	35.05	39.77	54.00	H
2483.500	42.86	27.55	4.90	34.99	40.32	54.00	H
2500.000	43.07	27.55	5.00	34.98	40.64	54.00	H

Test at Channel 6 (2.437 GHz) in transmitting status

Peak Measurement:

Frequency (MHz)	Reading Level (dB μ V)	Antenna factors (dB/m)	Cable loss (dB)	Preamp factor (dB)	Emission Level (dB μ V/m)	Limit (dB μ V/m)	Antenna polarization
2310.000	53.47	27.93	4.74	35.09	51.05	74.00	Vertical
2390.000	53.57	27.63	4.96	35.05	51.11	74.00	V
2483.500	55.28	27.55	4.90	34.99	52.74	74.00	V
2500.000	56.05	27.55	5.00	34.98	53.62	74.00	V
2310.000	54.43	27.93	4.74	35.09	52.01	74.00	Horizontal
2390.000	54.37	27.63	4.96	35.05	51.91	74.00	H
2483.500	54.78	27.55	4.90	34.99	52.24	74.00	H
2500.000	53.69	27.55	5.00	34.98	51.26	74.00	H

Average Measurement:

Frequency (MHz)	Reading Level (dB μ V)	Antenna factors (dB/m)	Cable loss (dB)	Preamp factor (dB)	Emission Level (dB μ V/m)	Limit (dB μ V/m)	Antenna polarization
2310.000	44.79	27.93	4.74	35.09	42.37	54.00	Vertical
2390.000	42.76	27.63	4.96	35.05	40.30	54.00	V
2483.500	44.49	27.55	4.90	34.99	41.95	54.00	V
2500.000	42.31	27.55	5.00	34.98	39.88	54.00	V
2310.000	43.37	27.93	4.74	35.09	40.95	54.00	Horizontal
2390.000	43.55	27.63	4.96	35.05	41.09	54.00	H
2483.500	42.85	27.55	4.90	34.99	40.31	54.00	H
2500.000	42.25	27.55	5.00	34.98	39.82	54.00	H

Test at Channel 11 (2.462 GHz) in transmitting status

Peak Measurement:

Frequency (MHz)	Reading Level (dBμV)	Antenna factors (dB/m)	Cable loss (dB)	Preamp factor (dB)	Emission Level (dBμV/m)	Limit (dBμV/m)	Antenna polarization
2310.000	54.01	27.93	4.74	35.09	51.59	74.00	Vertical
2390.000	54.30	27.63	4.96	35.05	51.84	74.00	V
2483.500	55.67	27.55	4.90	34.99	53.13	74.00	V
2500.000	54.63	27.55	5.00	34.98	52.20	74.00	V
2310.000	52.60	27.93	4.74	35.09	50.18	74.00	Horizontal
2390.000	55.77	27.63	4.96	35.05	53.31	74.00	H
2483.500	54.61	27.55	4.90	34.99	52.07	74.00	H
2500.000	53.60	27.55	5.00	34.98	51.17	74.00	H

Average Measurement:

Frequency (MHz)	Reading Level (dBμV)	Antenna factors (dB/m)	Cable loss (dB)	Preamp factor (dB)	Emission Level (dBμV/m)	Limit (dBμV/m)	Antenna polarization
2310.000	43.65	27.93	4.74	35.09	41.23	54.00	Vertical
2390.000	42.48	27.63	4.96	35.05	40.02	54.00	V
2483.500	44.11	27.55	4.90	34.99	41.57	54.00	V
2500.000	45.36	27.55	5.00	34.98	42.93	54.00	V
2310.000	44.39	27.93	4.74	35.09	41.97	54.00	Horizontal
2390.000	45.87	27.63	4.96	35.05	43.41	54.00	H
2483.500	43.31	27.55	4.90	34.99	40.77	54.00	H
2500.000	43.49	27.55	5.00	34.98	41.06	54.00	H

7.4.2.3 802.11n (HT20) mode with 72.2Mbps data rate

Test at Channel 1 (2.412 GHz) in transmitting status

Peak Measurement:

Frequency (MHz)	Reading Level (dBμV)	Antenna factors (dB/m)	Cable loss (dB)	Preamp factor (dB)	Emission Level (dBμV/m)	Limit (dBμV/m)	Antenna polarization
2310.000	53.99	27.93	4.74	35.09	51.57	74.00	Vertical
2390.000	56.06	27.63	4.96	35.05	53.60	74.00	V
2483.500	53.95	27.55	4.90	34.99	51.41	74.00	V
2500.000	54.66	27.55	5.00	34.98	52.23	74.00	V
2310.000	54.76	27.93	4.74	35.09	52.34	74.00	Horizontal
2390.000	55.01	27.63	4.96	35.05	52.55	74.00	H
2483.500	54.84	27.55	4.90	34.99	52.30	74.00	H
2500.000	54.95	27.55	5.00	34.98	52.52	74.00	H

Average Measurement:

Frequency (MHz)	Reading Level (dBμV)	Antenna factors (dB/m)	Cable loss (dB)	Preamp factor (dB)	Emission Level (dBμV/m)	Limit (dBμV/m)	Antenna polarization
2310.000	41.82	27.93	4.74	35.09	39.40	54.00	Vertical
2390.000	43.86	27.63	4.96	35.05	41.40	54.00	V
2483.500	42.05	27.55	4.90	34.99	39.51	54.00	V
2500.000	42.57	27.55	5.00	34.98	40.14	54.00	V
2310.000	44.54	27.93	4.74	35.09	42.12	54.00	Horizontal
2390.000	42.10	27.63	4.96	35.05	39.64	54.00	H
2483.500	42.38	27.55	4.90	34.99	39.84	54.00	H
2500.000	45.34	27.55	5.00	34.98	42.91	54.00	H

Test at Channel 6 (2.437 GHz) in transmitting status

Peak Measurement:

Frequency (MHz)	Reading Level (dBμV)	Antenna factors (dB/m)	Cable loss (dB)	Preamp factor (dB)	Emission Level (dBμV/m)	Limit (dBμV/m)	Antenna polarization
2310.000	54.38	27.93	4.74	35.09	51.96	74.00	Vertical
2390.000	53.25	27.63	4.96	35.05	50.79	74.00	V
2483.500	56.08	27.55	4.90	34.99	53.54	74.00	V
2500.000	54.87	27.55	5.00	34.98	52.44	74.00	V
2310.000	55.99	27.93	4.74	35.09	53.57	74.00	Horizontal
2390.000	52.63	27.63	4.96	35.05	50.17	74.00	H
2483.500	55.63	27.55	4.90	34.99	53.09	74.00	H
2500.000	53.07	27.55	5.00	34.98	50.64	74.00	H

Average Measurement:

Frequency (MHz)	Reading Level (dBμV)	Antenna factors (dB/m)	Cable loss (dB)	Preamp factor (dB)	Emission Level (dBμV/m)	Limit (dBμV/m)	Antenna polarization
2310.000	43.99	27.93	4.74	35.09	41.57	54.00	Vertical
2390.000	41.99	27.63	4.96	35.05	39.53	54.00	V
2483.500	43.30	27.55	4.90	34.99	40.76	54.00	V
2500.000	42.04	27.55	5.00	34.98	39.61	54.00	V
2310.000	43.42	27.93	4.74	35.09	41.00	54.00	Horizontal
2390.000	43.00	27.63	4.96	35.05	40.54	54.00	H
2483.500	43.27	27.55	4.90	34.99	40.73	54.00	H
2500.000	44.78	27.55	5.00	34.98	42.35	54.00	H

Test at Channel 11 (2.462 GHz) in transmitting status

Peak Measurement:

Frequency (MHz)	Reading Level (dBµV)	Antenna factors (dB/m)	Cable loss (dB)	Preamp factor (dB)	Emission Level (dBµV/m)	Limit (dBµV/m)	Antenna polarization
2310.000	54.00	27.93	4.74	35.09	51.58	74.00	Vertical
2390.000	54.22	27.63	4.96	35.05	51.76	74.00	V
2483.500	53.41	27.55	4.90	34.99	50.87	74.00	V
2500.000	54.10	27.55	5.00	34.98	51.67	74.00	V
2310.000	53.88	27.93	4.74	35.09	51.46	74.00	Horizontal
2390.000	53.65	27.63	4.96	35.05	51.19	74.00	H
2483.500	53.90	27.55	4.90	34.99	51.36	74.00	H
2500.000	55.48	27.55	5.00	34.98	53.05	74.00	H

Average Measurement:

Frequency (MHz)	Reading Level (dBµV)	Antenna factors (dB/m)	Cable loss (dB)	Preamp factor (dB)	Emission Level (dBµV/m)	Limit (dBµV/m)	Antenna polarization
2310.000	42.95	27.93	4.74	35.09	40.53	54.00	Vertical
2390.000	44.08	27.63	4.96	35.05	41.62	54.00	V
2483.500	42.30	27.55	4.90	34.99	39.76	54.00	V
2500.000	42.91	27.55	5.00	34.98	40.48	54.00	V
2310.000	42.09	27.93	4.74	35.09	39.67	54.00	Horizontal
2390.000	44.36	27.63	4.96	35.05	41.90	54.00	H
2483.500	45.03	27.55	4.90	34.99	42.49	54.00	H
2500.000	44.77	27.55	5.00	34.98	42.34	54.00	H

7.4.2.4 802.11n (HT40) mode with 150Mbps data rate

Test at Channel 3 (2.422 GHz) in transmitting status

Peak Measurement:

Frequency (MHz)	Reading Level (dBμV)	Antenna factors (dB/m)	Cable loss (dB)	Preamp factor (dB)	Emission Level (dBμV/m)	Limit (dBμV/m)	Antenna polarization
2310.000	54.91	27.93	4.74	35.09	52.49	74.00	Vertical
2390.000	54.30	27.63	4.96	35.05	51.84	74.00	V
2483.500	54.28	27.55	4.90	34.99	51.74	74.00	V
2500.000	54.16	27.55	5.00	34.98	51.73	74.00	V
2310.000	54.16	27.93	4.74	35.09	51.74	74.00	Horizontal
2390.000	55.78	27.63	4.96	35.05	53.32	74.00	H
2483.500	56.21	27.55	4.90	34.99	53.67	74.00	H
2500.000	53.65	27.55	5.00	34.98	51.22	74.00	H

Average Measurement:

Frequency (MHz)	Reading Level (dBμV)	Antenna factors (dB/m)	Cable loss (dB)	Preamp factor (dB)	Emission Level (dBμV/m)	Limit (dBμV/m)	Antenna polarization
2310.000	40.55	27.93	4.74	35.09	38.13	54.00	Vertical
2390.000	42.55	27.63	4.96	35.05	40.09	54.00	V
2483.500	43.66	27.55	4.90	34.99	41.12	54.00	V
2500.000	44.39	27.55	5.00	34.98	41.96	54.00	V
2310.000	41.72	27.93	4.74	35.09	39.30	54.00	Horizontal
2390.000	41.63	27.63	4.96	35.05	39.17	54.00	H
2483.500	43.23	27.55	4.90	34.99	40.69	54.00	H
2500.000	42.73	27.55	5.00	34.98	40.30	54.00	H

Test at Channel 6 (2.437 GHz) in transmitting status

Peak Measurement:

Frequency (MHz)	Reading Level (dBμV)	Antenna factors (dB/m)	Cable loss (dB)	Preamp factor (dB)	Emission Level (dBμV/m)	Limit (dBμV/m)	Antenna polarization
2310.000	53.09	27.93	4.74	35.09	50.67	74.00	Vertical
2390.000	54.56	27.63	4.96	35.05	52.10	74.00	V
2483.500	53.36	27.55	4.90	34.99	50.82	74.00	V
2500.000	55.11	27.55	5.00	34.98	52.68	74.00	V
2310.000	56.20	27.93	4.74	35.09	53.78	74.00	Horizontal
2390.000	54.85	27.63	4.96	35.05	52.39	74.00	H
2483.500	53.83	27.55	4.90	34.99	51.29	74.00	H
2500.000	54.71	27.55	5.00	34.98	52.28	74.00	H

Average Measurement:

Frequency (MHz)	Reading Level (dBμV)	Antenna factors (dB/m)	Cable loss (dB)	Preamp factor (dB)	Emission Level (dBμV/m)	Limit (dBμV/m)	Antenna polarization
2310.000	44.93	27.93	4.74	35.09	42.51	54.00	Vertical
2390.000	40.07	27.63	4.96	35.05	37.61	54.00	V
2483.500	42.31	27.55	4.90	34.99	39.77	54.00	V
2500.000	42.86	27.55	5.00	34.98	40.43	54.00	V
2310.000	44.15	27.93	4.74	35.09	41.73	54.00	Horizontal
2390.000	44.29	27.63	4.96	35.05	41.83	54.00	H
2483.500	42.36	27.55	4.90	34.99	39.82	54.00	H
2500.000	42.80	27.55	5.00	34.98	40.37	54.00	H

Test at Channel 9 (2.452 GHz) in transmitting status

Peak Measurement:

Frequency (MHz)	Reading Level (dBμV)	Antenna factors (dB/m)	Cable loss (dB)	Preamp factor (dB)	Emission Level (dBμV/m)	Limit (dBμV/m)	Antenna polarization
2310.000	54.86	27.93	4.74	35.09	52.44	74.00	Vertical
2390.000	56.13	27.63	4.96	35.05	53.67	74.00	V
2483.500	54.15	27.55	4.90	34.99	51.61	74.00	V
2500.000	53.11	27.55	5.00	34.98	50.68	74.00	V
2310.000	52.95	27.93	4.74	35.09	50.53	74.00	Horizontal
2390.000	55.29	27.63	4.96	35.05	52.83	74.00	H
2483.500	53.96	27.55	4.90	34.99	51.42	74.00	H
2500.000	55.19	27.55	5.00	34.98	52.76	74.00	H

Average Measurement:

Frequency (MHz)	Reading Level (dBμV)	Antenna factors (dB/m)	Cable loss (dB)	Preamp factor (dB)	Emission Level (dBμV/m)	Limit (dBμV/m)	Antenna polarization
2310.000	43.50	27.93	4.74	35.09	41.08	54.00	Vertical
2390.000	45.34	27.63	4.96	35.05	42.88	54.00	V
2483.500	42.67	27.55	4.90	34.99	40.13	54.00	V
2500.000	41.54	27.55	5.00	34.98	39.11	54.00	V
2310.000	42.93	27.93	4.74	35.09	40.51	54.00	Horizontal
2390.000	42.04	27.63	4.96	35.05	39.58	54.00	H
2483.500	42.41	27.55	4.90	34.99	39.87	54.00	H
2500.000	43.14	27.55	5.00	34.98	40.71	54.00	H

7.5 6 dB Bandwidth

Test Requirement: FCC Part 15 C section 15.247
 (a)(2) Systems using digital modulation techniques may operate in the 902-928 MHz, 2400-2483.5MHz, and 5725-5850 MHz bands. The minimum 6 dB bandwidth shall be at least 500 kHz.

Test Method: ANSI C63.10: Clause 6.9.1

Test Status: Pre-Scan has been conducted to determine the worst-case mode from all possible combinations between available modulations, data rates and antenna ports (if EUT with antenna diversity architecture). Following channel(s) was (were) selected for the final test as listed below.
 Pre-Test the EUT using external Standard DC power source for powering on the board.

Test Configuration:

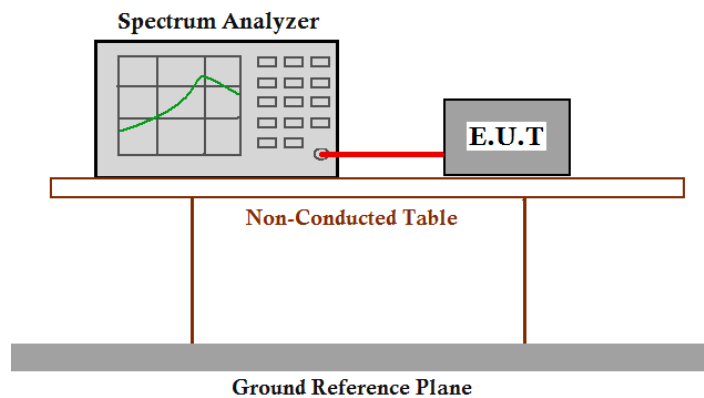

Test Procedure:

1. Remove the antenna from the EUT and then connect a low attention attenuation RF cable (cable loss =1.5dB) from the antenna port to the spectrum.
2. Set the spectrum analyzer:
 Sweep = auto; Detector Function = Peak; ace = Max Hold
 RBW: 1%~5% OBW; VBW: $\geq 3 \cdot RBW$
 Span: two times and five times the OBW.
3. Mark the peak power frequency and -6dB (upper and lower) power frequency.
4. Repeat until all the test status is investigated.
5. Report the worse case.

ANT J2

Channel No.	Frequency (MHz)	Mode	Data Rate	Measured 6dB bandwidth (MHz)	Limit	Result
1	2412	802.11b	11 Mbps	10.658	≥500KHz	Pass
6	2437		11 Mbps	11.056		Pass
11	2462		11 Mbps	9.667		Pass
1	2412	802.11g	54 Mbps	15.405	≥500KHz	Pass
6	2437		54 Mbps	15.398		Pass
11	2462		54 Mbps	15.630		Pass
1	2412	802.11n (HT20)	72.2 Mbps	15.695	≥500KHz	Pass
6	2437		72.2 Mbps	15.687		Pass
11	2462		72.2 Mbps	15.514		Pass
3	2422	802.11n (HT40)	150 Mbps	34.960	≥500KHz	Pass
6	2437		150 Mbps	34.960		Pass
9	2452		150 Mbps	34.960		Pass

Test result: The unit does meet the FCC requirements.

ANT J4

Channel No.	Frequency (MHz)	Mode	Data Rate	Measured 6dB bandwidth (MHz)	Limit	Result
1	2412	802.11b	11 Mbps	10.072	≥500KHz	Pass
6	2437		11 Mbps	10.080		Pass
11	2462		11 Mbps	11.939		Pass
1	2412	802.11g	54 Mbps	15.051	≥500KHz	Pass
6	2437		54 Mbps	15.116		Pass
11	2462		54 Mbps	15.123		Pass
1	2412	802.11n (HT20)	72.2 Mbps	15.166	≥500KHz	Pass
6	2437		72.2 Mbps	15.174		Pass
11	2462		72.2 Mbps	15.181		Pass

Result plot as follows: ANT J2

802.11b mode with 11Mbps data rate

Channel 1: 2.412GHz:

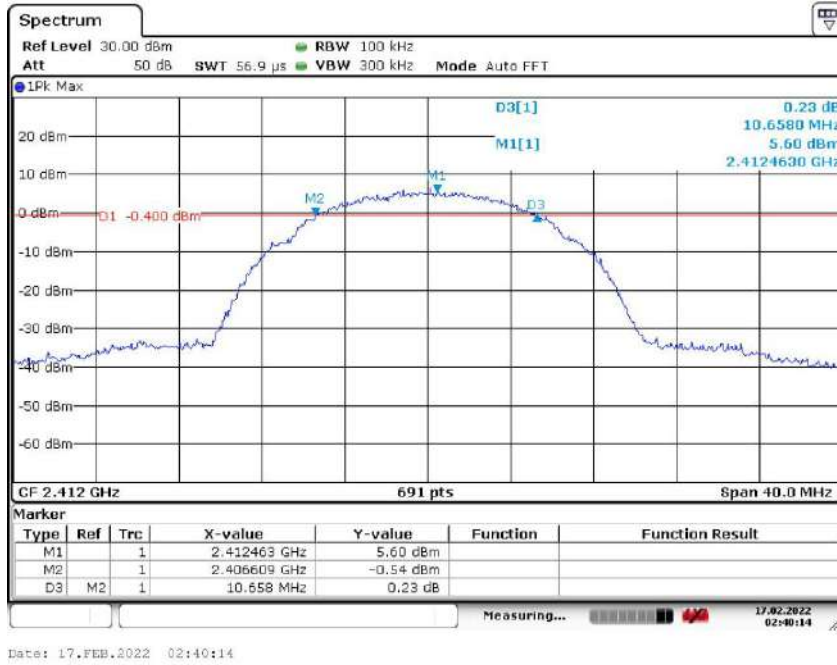

Channel 6: 2.437GHz:

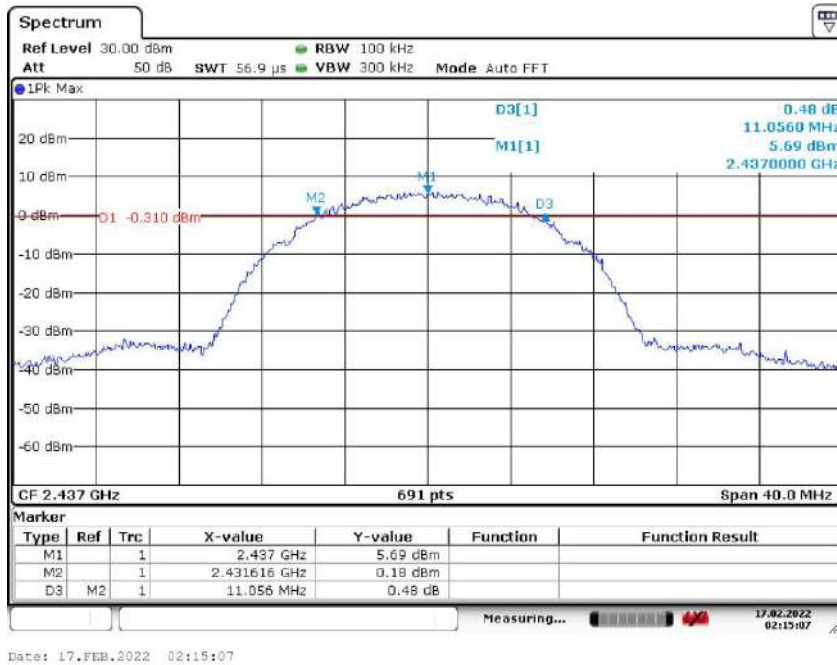

Channel 11: 2.462GHz:

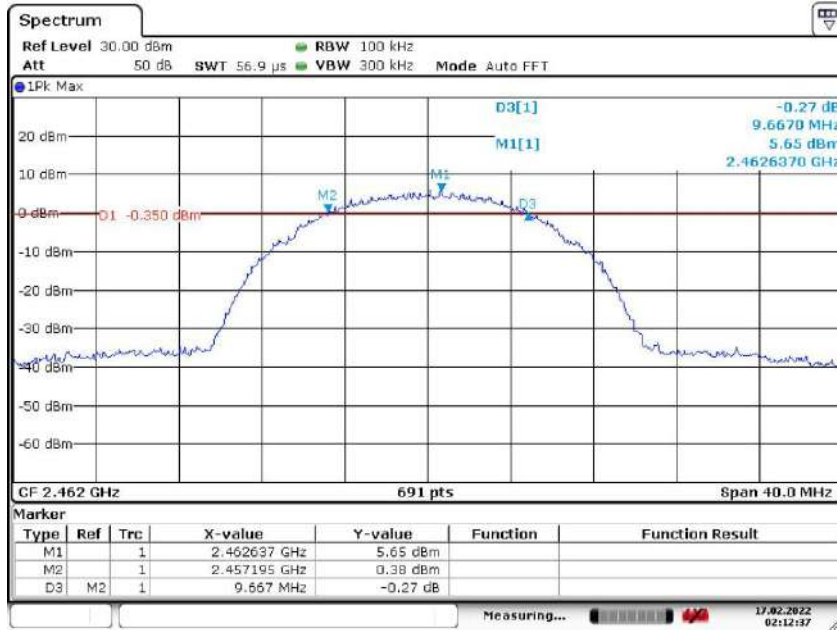

Date: 17.FEB.2022 02:12:36

802.11g mode with 54Mbps data rate

Channel 1: 2.412GHz:

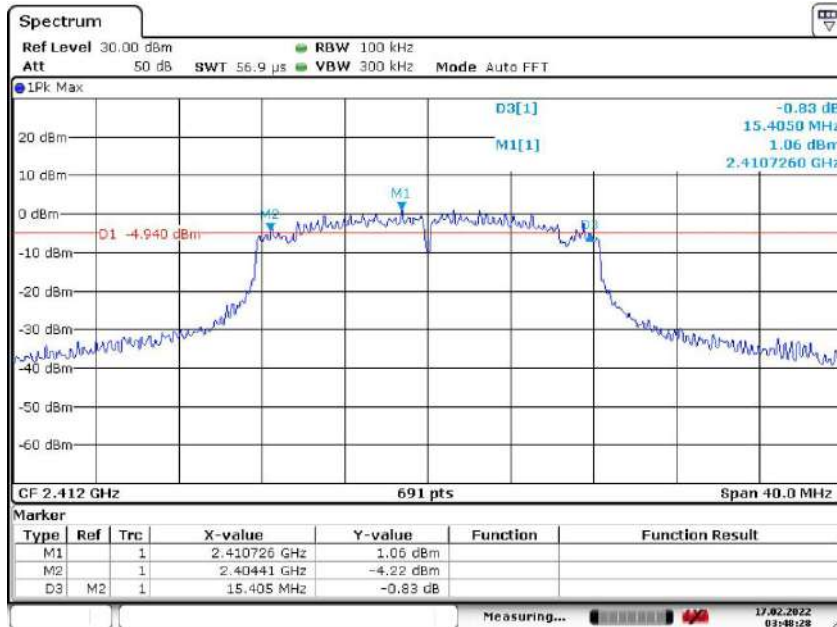

Date: 17.FEB.2022 03:48:27

Channel 6: 2.437GHz:

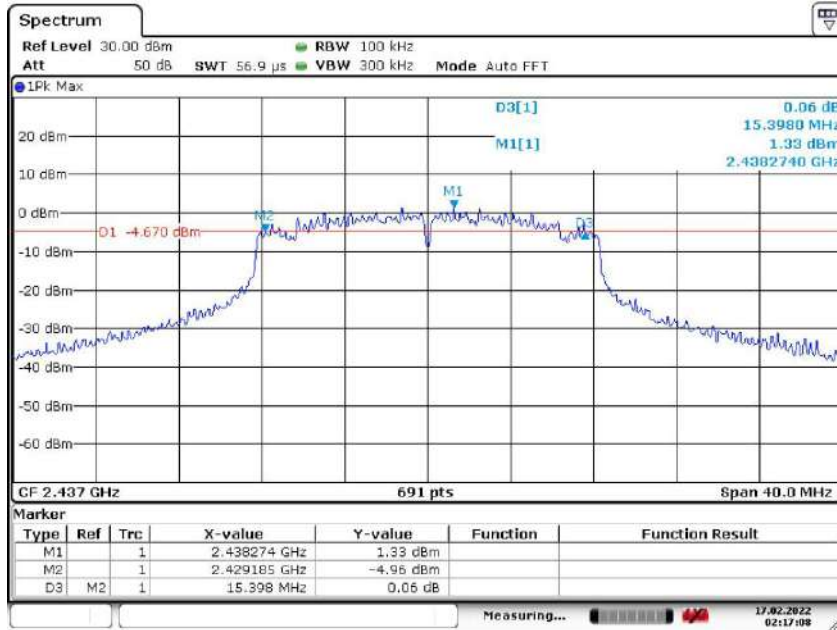

Date: 17.FEB.2022 02:17:08

Channel 11: 2.462GHz:

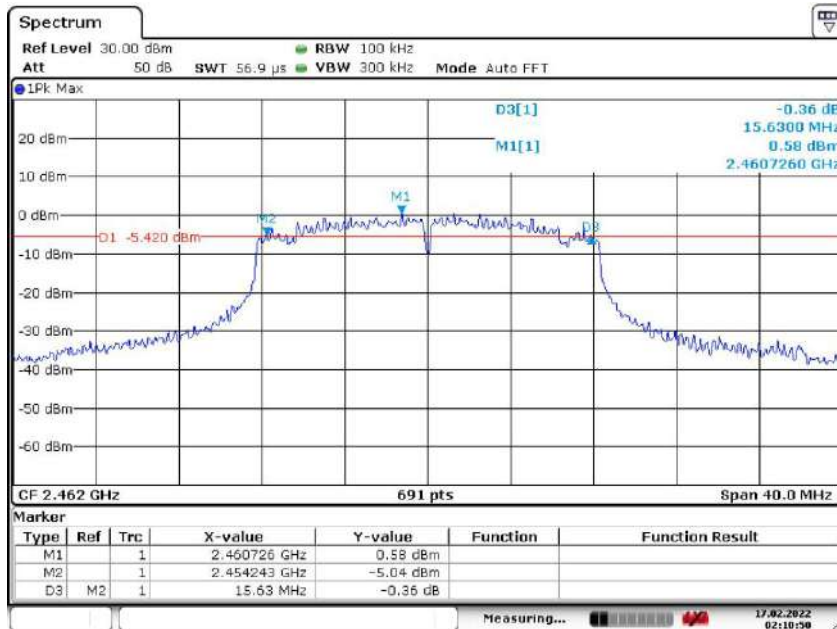

Date: 17.FEB.2022 02:10:50

802.11n(HT20) mode with 72.2Mbps data rate

Channel 1: 2.412GHz:

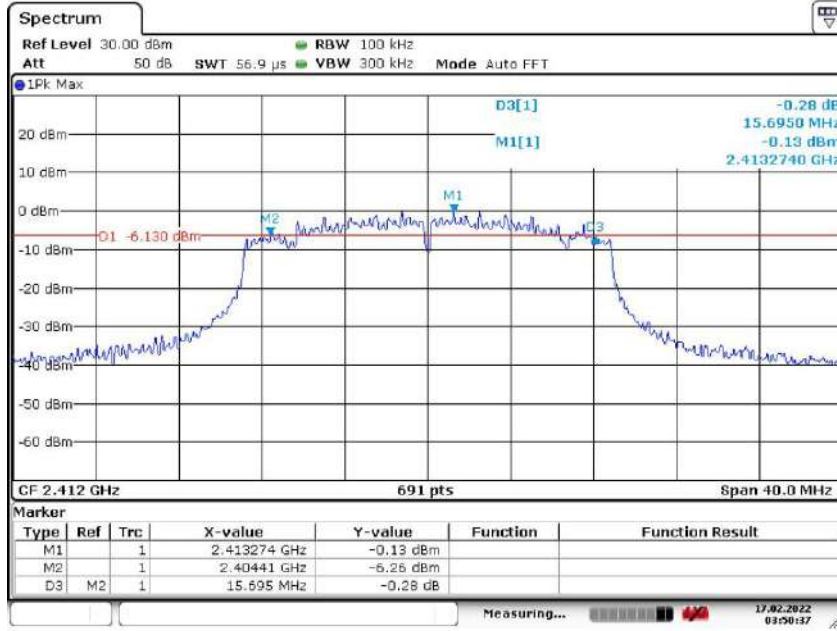

Date: 17.FEB.2022 03:50:37

Channel 6: 2.437GHz:

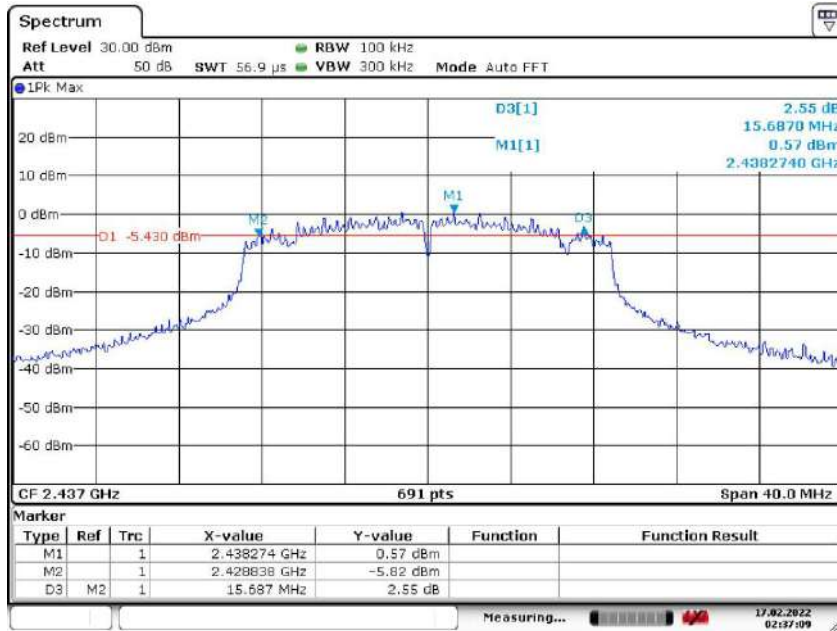

Date: 17.FEB.2022 02:37:09

Channel 11: 2.462GHz:

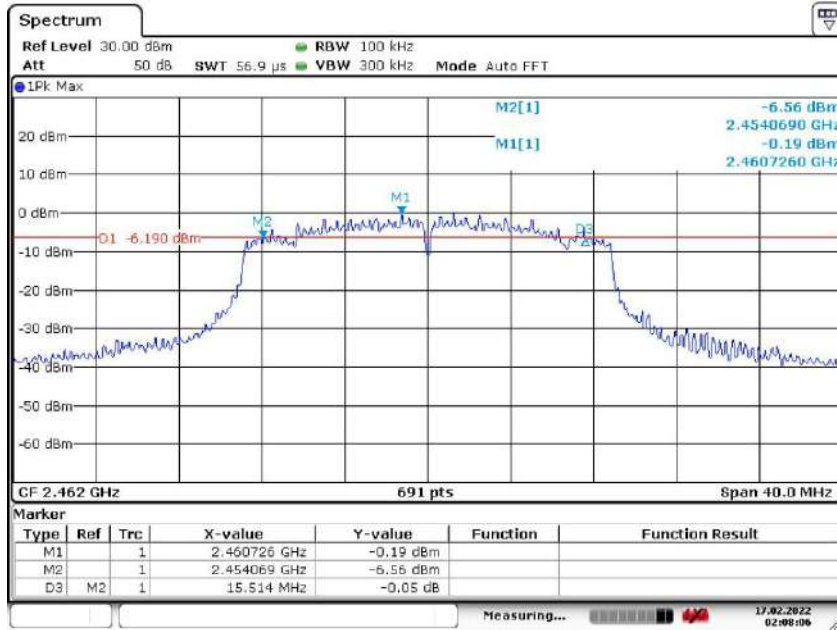

Date: 17.FEB.2022 02:08:06

802.11n(HT40) mode with 150Mbps data rate

Channel 3: 2.422GHz:

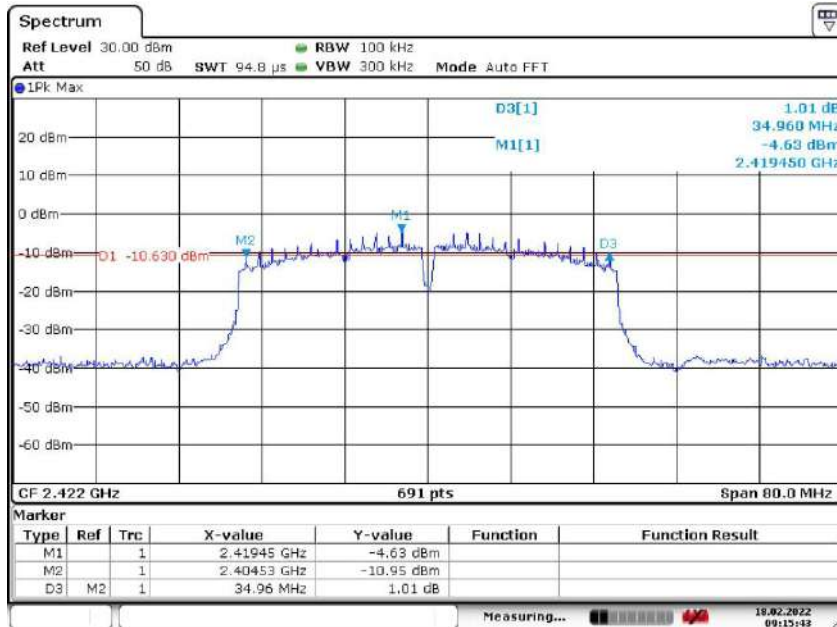

Date: 18.FEB.2022 09:15:44

Channel 6: 2.437GHz:

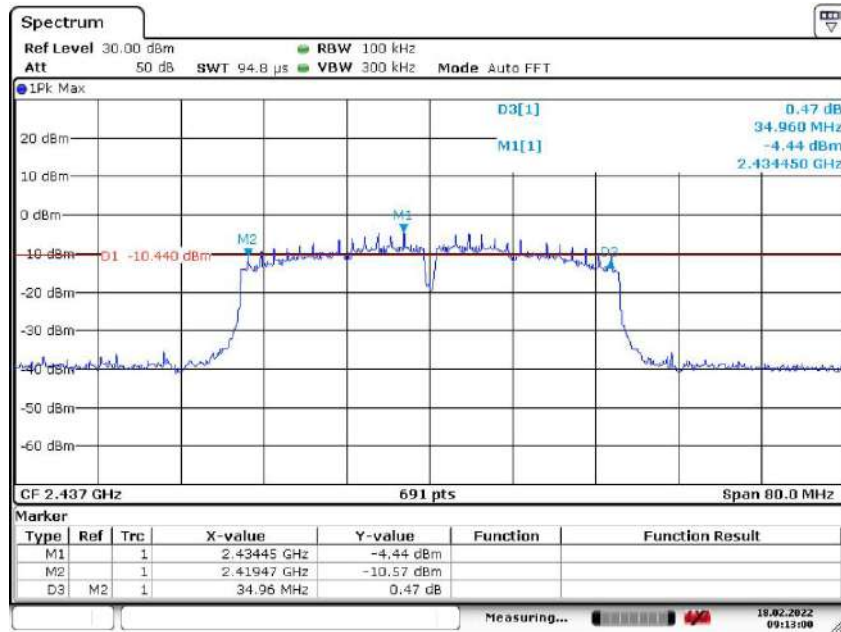

Date: 18.FEB.2022 09:13:00

Channel 9: 2.452GHz:

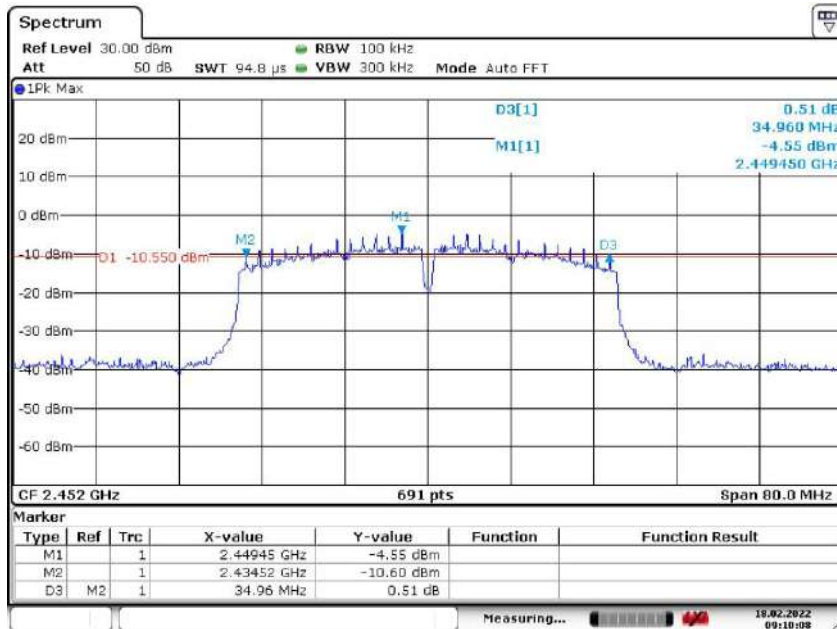

Date: 18.FEB.2022 09:10:09

Result plot as follows: ANT J4

802.11b mode with 11Mbps data rate

Channel 1: 2.412GHz:

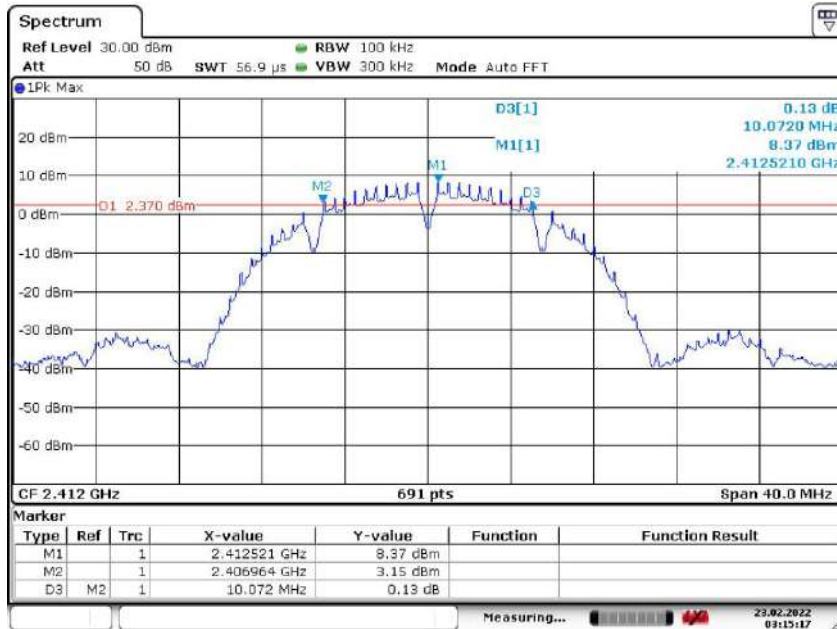

Date: 23.FEB.2022 03:15:17

Channel 6: 2.437GHz:

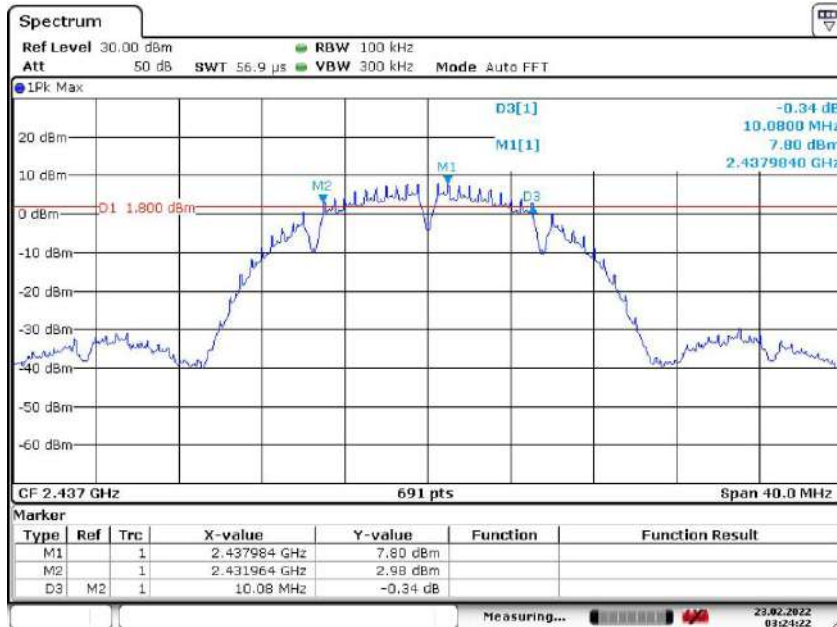

Date: 23.FEB.2022 03:24:22

Channel 11: 2.462GHz:

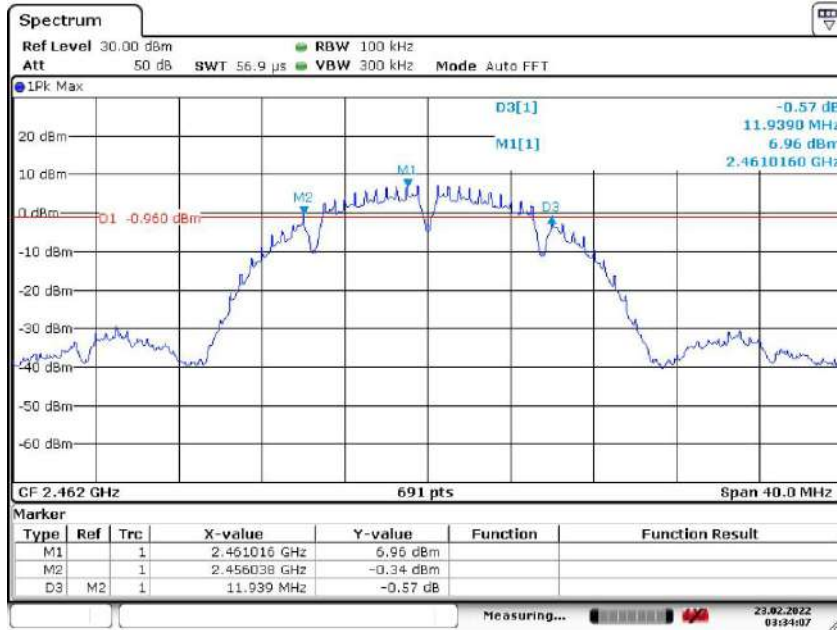

Date: 23.FEB.2022 03:34:07

802.11g mode with 54Mbps data rate

Channel 1: 2.412GHz:

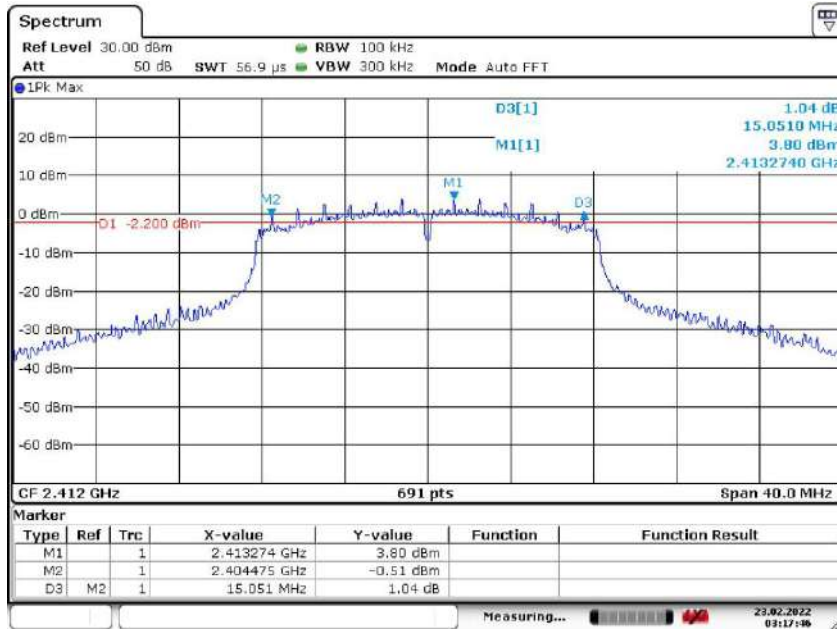

Date: 23.FEB.2022 03:17:46

Channel 6: 2.437GHz:

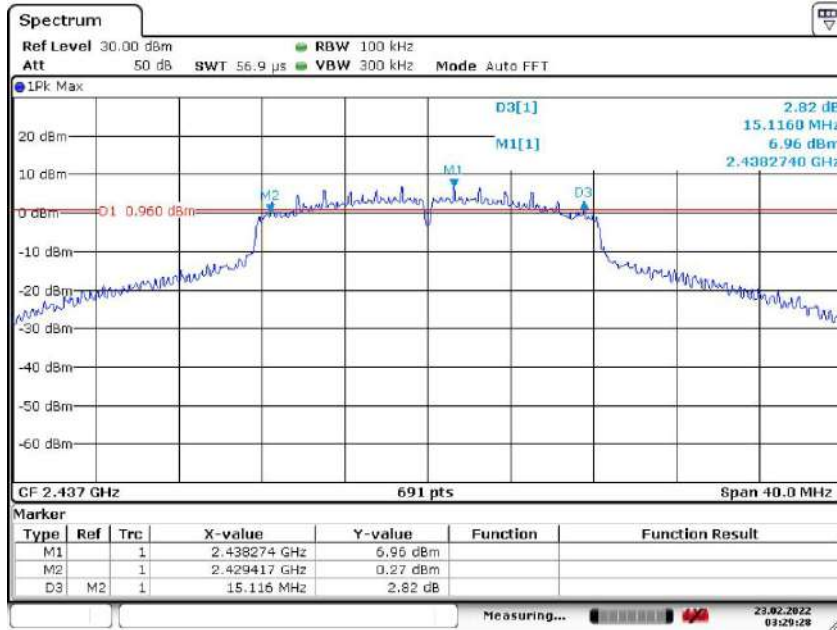

Date: 23.FEB.2022 03:29:27

Channel 11: 2.462GHz:

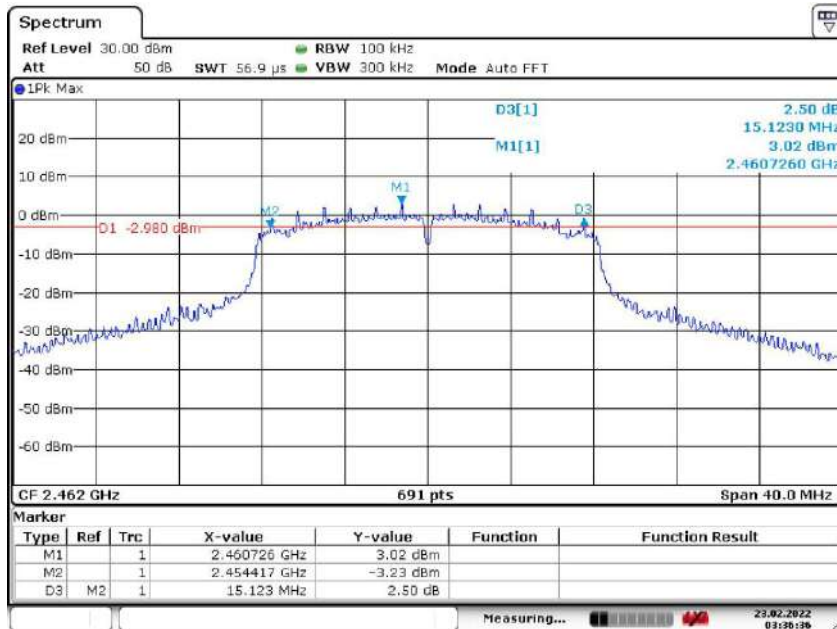

Date: 23.FEB.2022 03:36:36

802.11n(HT20) mode with 72.2Mbps data rate

Channel 1: 2.412GHz:

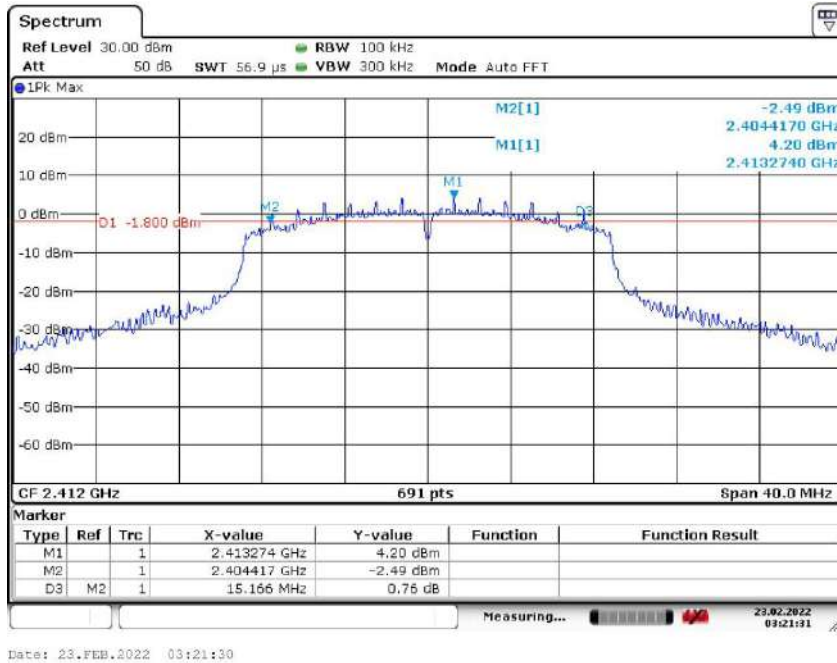

Channel 6: 2.437GHz:

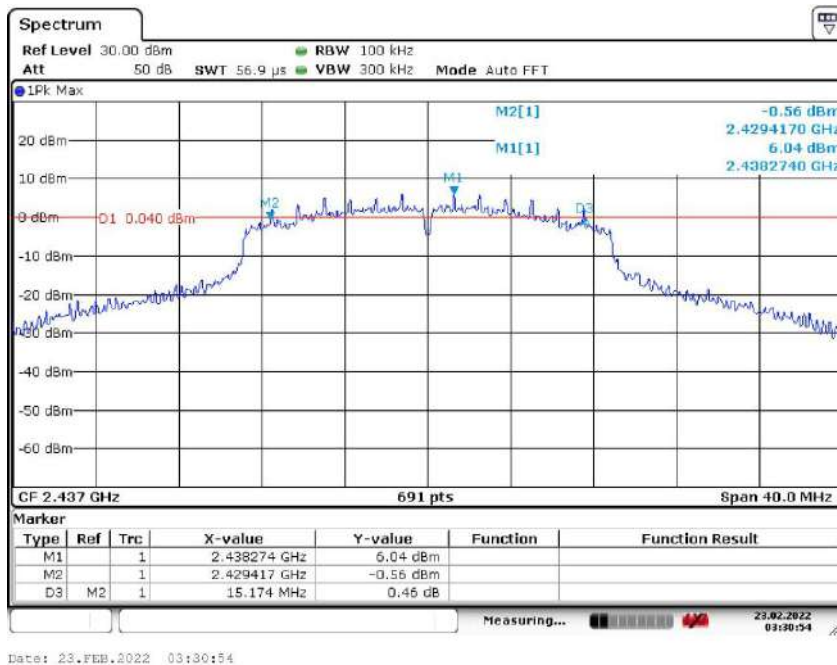

Channel 11: 2.462GHz:

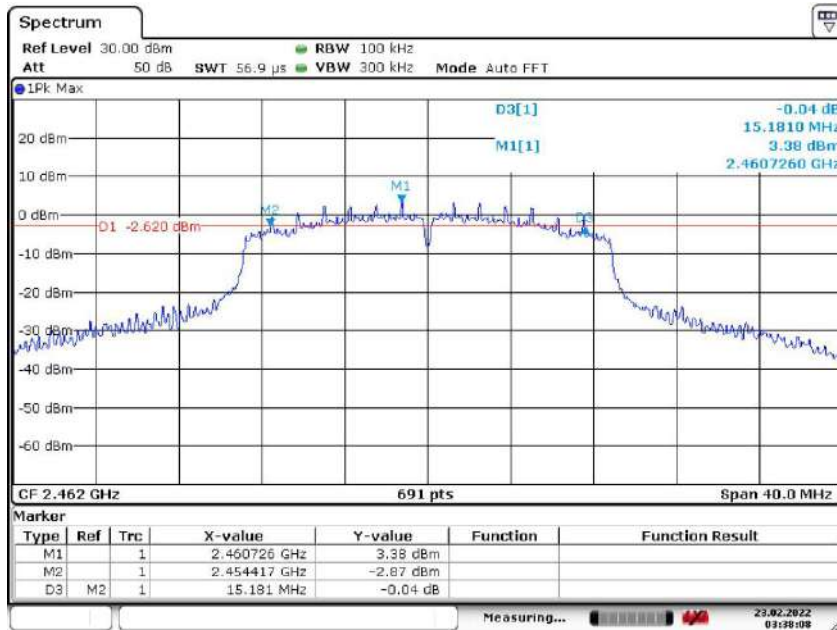

Date: 23.FEB.2022 03:38:08

7.6 Maximum Peak Output Power

Test Requirement: FCC Part 15 C section 15.247
 (b)(3) For systems using digital modulation in the 902-928 MHz, 2400-2483.5 MHz, and 5725-5850 MHz bands: 1 Watt.
 Except as shown in paragraph (c) of this section, if transmitting antennas of directional gain greater than 6 dBi are used, the conducted output power from the intentional radiator shall be reduced below the stated values in paragraphs (b) (1), (b) (2), and (b) (3) of this section, as appropriate, by the amount in dB that the directional gain of the antenna exceeds 6 dBi.

Test Method: FCC/KDB-558074 D01 v03r03 9.1.1 RBW \geq DTS bandwidth

Test Status: Pre-Scan has been conducted to determine the worst-case mode from all possible combinations between available modulations, data rates and antenna ports (if EUT with antenna diversity architecture). Following channel(s) was (were) selected for the final test as listed below.
 Pre-Test the EUT using external Standard DC power source for powering on the board.

Test Configuration:

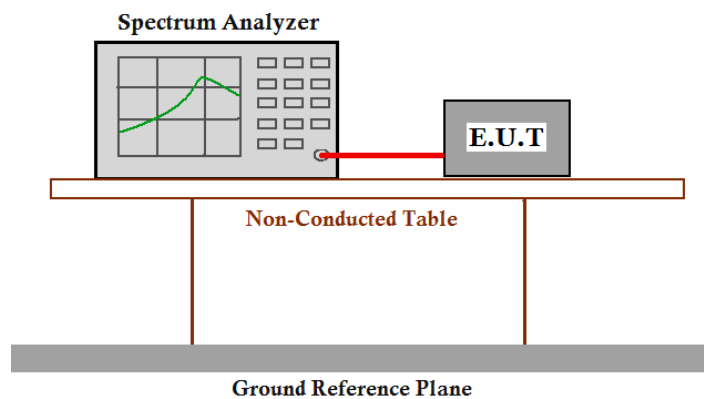

Test Procedure:

1. Remove the antenna from the EUT and then connect a low attention attenuation RF cable
(Cable loss =1.0dB) from the antenna port to the spectrum.
2. Set the RBW \geq DTS bandwidth
3. Set the VBW \geq 3 x RBW
4. Set the span \geq 3 x RBW.
5. Detector = peak.
6. Sweep time = auto couple.
7. Trace mode = max hold.
8. Use peak marker function to determine the peak amplitude level.
9. Report the worse case.

Test result: ANT J2

Channel No.	Frequency (MHz)	Mode	Data Rate	Measured Channel Power (dBm)	Limit	Result
1	2412	802.11b	11 Mbps	22.63	1W(30dBm)	Pass
6	2437		11 Mbps	22.36		Pass
11	2462		11 Mbps	21.77		Pass
1	2412	802.11g	54 Mbps	19.52		Pass
6	2437		54 Mbps	19.91		Pass
11	2462		54 Mbps	19.10		Pass
1	2412	802.11n (HT20)	72.2 Mbps	18.52		Pass
6	2437		72.2 Mbps	18.89		Pass
11	2462		72.2 Mbps	18.18		Pass
3	2422	802.11n (HT40)	150 Mbps	16.46		Pass
6	2437		150 Mbps	16.17		Pass
9	2452		150 Mbps	15.88		Pass

Remark: Level = Read Level + Cable Loss.

The unit does meet the FCC requirements.

Test result: ANT J4

Channel No.	Frequency (MHz)	Mode	Data Rate	Measured Channel Power (dBm)	Limit	Result
1	2412	802.11b	11 Mbps	19.69	1W(30dBm)	Pass
6	2437		11 Mbps	19.53		Pass
11	2462		11 Mbps	19.02		Pass
1	2412	802.11g	54 Mbps	21.39		Pass
6	2437		54 Mbps	24.03		Pass
11	2462		54 Mbps	21.29		Pass
1	2412	802.11n (HT20)	72.2 Mbps	21.60		Pass
6	2437		72.2 Mbps	23.32		Pass
11	2462		72.2 Mbps	21.37		Pass

7.7 Peak Power Spectral Density

Test Requirement:

FCC Part 15 C section 15.247

(e) For digitally modulated systems, the power spectral density conducted from the intentional radiator to the antenna shall not be greater than 8 dBm in any 3 kHz band during any time interval of continuous transmission.

This power spectral density shall be determined in accordance with the provisions of paragraph (b) of this section. The same method of determining the conducted output power shall be used to determine the power spectral density.

Test Method:

ANSI C63.10: Clause 6.11.2.3

Test Status:

Pre-Scan has been conducted to determine the worst-case mode from all possible combinations between available modulations, data rates and antenna ports (if EUT with antenna diversity architecture). Following channel(s) was (were) selected for the final test as listed below.

Pre-Test the EUT using external Standard DC power source for powering on the board.

Test Configuration:

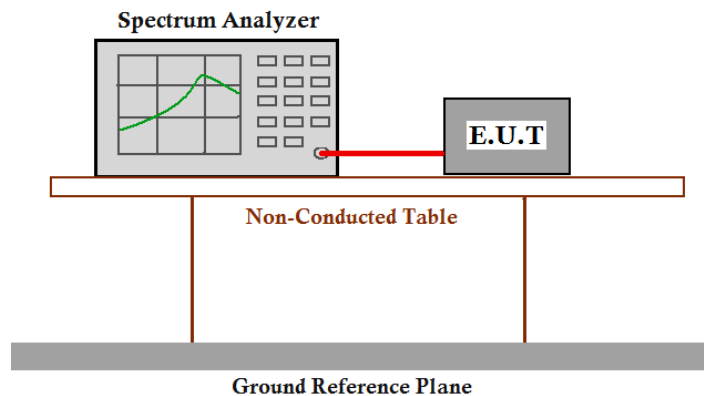

Test Procedure:

1. Remove the antenna from the EUT and then connect a low attention attenuation RF cable (cable loss =1.0 dB) from the antenna port to the spectrum analyzer or power meter.
2. Set the spectrum analyzer:
 - a) Set CENTER FREQUENCY = Frequency from Power Spectral Density Test Matrix (see 6.10.2)
 - b) Set SPAN = 20 MHz (For devices with a nominal 40 MHz BW, 50 MHz span will be needed)
 - c) Set REFERENCE LEVEL = 20 dBm
 - d) Set ATTENUATION = 0 dB (add internal attenuation, if necessary)
 - e) Set SWEEP TIME = Coupled
 - f) Set RBW = 3 kHz
 - g) Set VBW = 10 kHz
 - h) Set DETECTOR = Peak
 - i) Set MKR = Center Frequency
 - j) Set TRACE = CLEAR WRITE

Place the radio in continuous transmit mode. Set the TRACE to MAX HOLD, and after the trace stabilizes, the TRACE to VIEW. Set the marker on the peak of the signal and then adjust the center frequency of the spectrum analyzer to the marker frequency.

After viewing the EUT waveform on the spectrum analyzer, perform the following spectrum analyzer functions to capture the trace:

Set SPAN = 300 kHz

Set SWEEP TIME = 100 s

Set TRACE = MAX HOLD

Set MKR = PEAK SEARCH

3. Measure the Power Spectral Density of the test frequency with special test status.
4. Repeat until all the test status is investigated.
5. Report the worse case.

Test result: ANT J2

Channel No.	Frequency (MHz)	Mode	Data Rate	Measured Peak Power Spectral Density (dBm/3KHz)	Limit	Result
1	2412	802.11b	11 Mbps	-8.96	8dBm/3KHz	Pass
6	2437		11 Mbps	-8.06		Pass
11	2462		11 Mbps	-7.98		Pass
1	2412	802.11g	54 Mbps	-14.71		Pass
6	2437		54 Mbps	-14.05		Pass
11	2462		54 Mbps	-14.40		Pass
1	2412	802.11n (HT20)	72.2 Mbps	-13.16		Pass
6	2437		72.2 Mbps	-16.14		Pass
11	2462		72.2 Mbps	-13.64		Pass
3	2422	802.11n (HT40)	150 Mbps	-16.96		Pass
6	2437		150Mbps	-17.03		Pass
9	2452		150 Mbps	-17.57		Pass

Test result: Level = Read Level + Cable Loss.

The unit does meet the FCC requirements.

Test result: ANT J4

Channel No.	Frequency (MHz)	Mode	Data Rate	Measured Peak Power Spectral Density (dBm/3KHz)	Limit	Result
1	2412	802.11b	11 Mbps	-4.27	8dBm/3KHz	Pass
6	2437		11 Mbps	-4.68		Pass
11	2462		11 Mbps	-4.68		Pass
1	2412	802.11g	54 Mbps	-9.30		Pass
6	2437		54 Mbps	-6.42		Pass
11	2462		54 Mbps	-11.10		Pass
1	2412	802.11n (HT20)	72.2 Mbps	-9.03		Pass
6	2437		72.2 Mbps	-6.67		Pass
11	2462		72.2 Mbps	-9.37		Pass

Result plot as follows: ANT J2

802.11b mode with 11Mbps data rate

Channel 1: 2.412GHz:

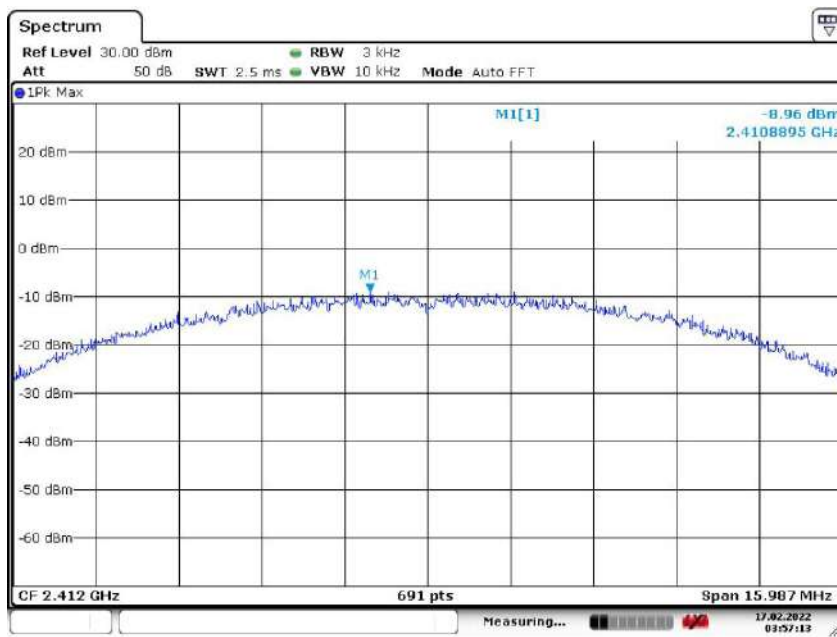

Channel 6: 2.437GHz:

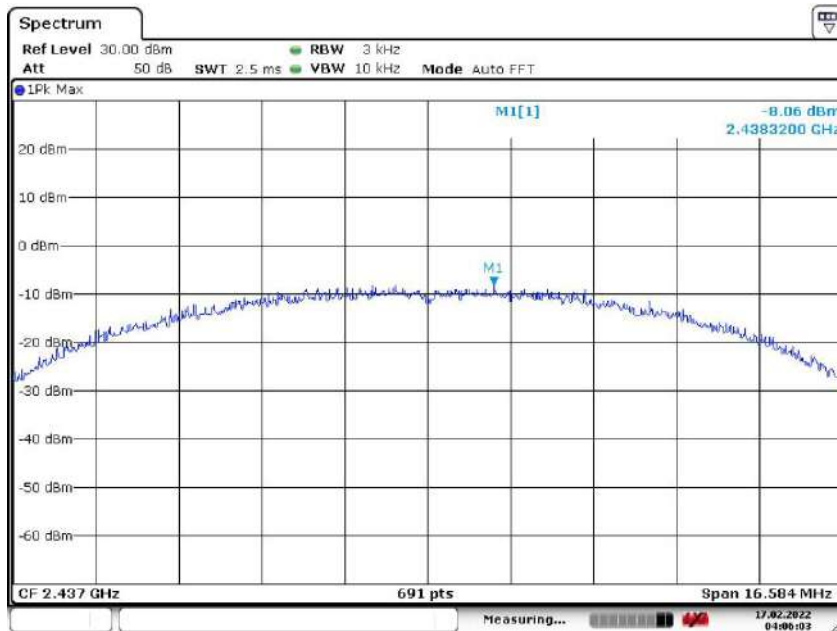

Date: 17.FEB.2022 04:06:03

Channel 11: 2.462GHz:

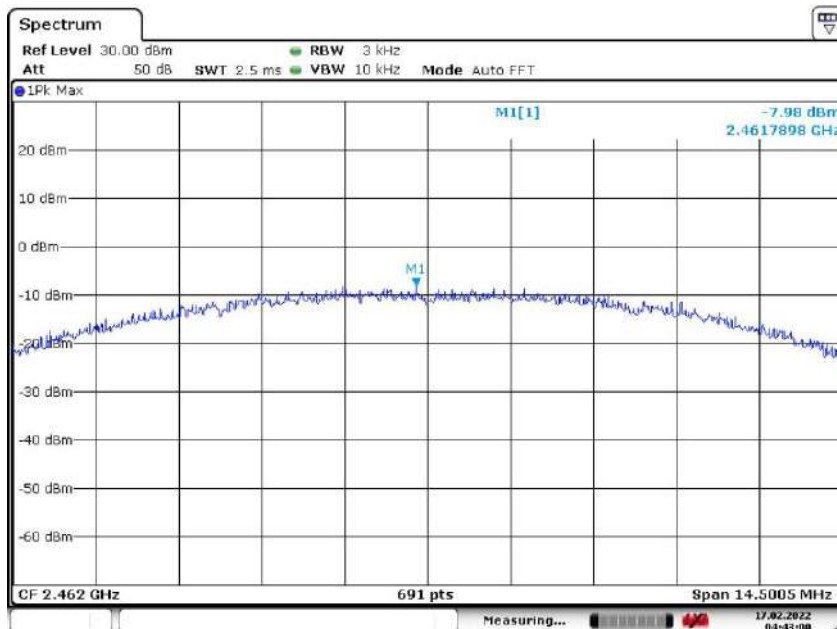

Date: 17.FEB.2022 04:43:00

802.11g mode with 54Mbps data rate

Channel 1: 2.412GHz:

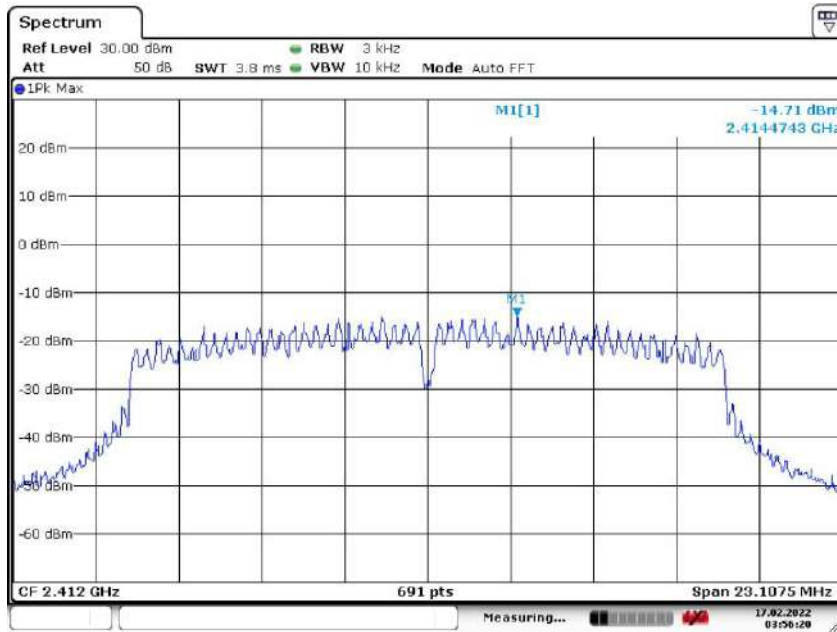

Channel 6: 2.437GHz:

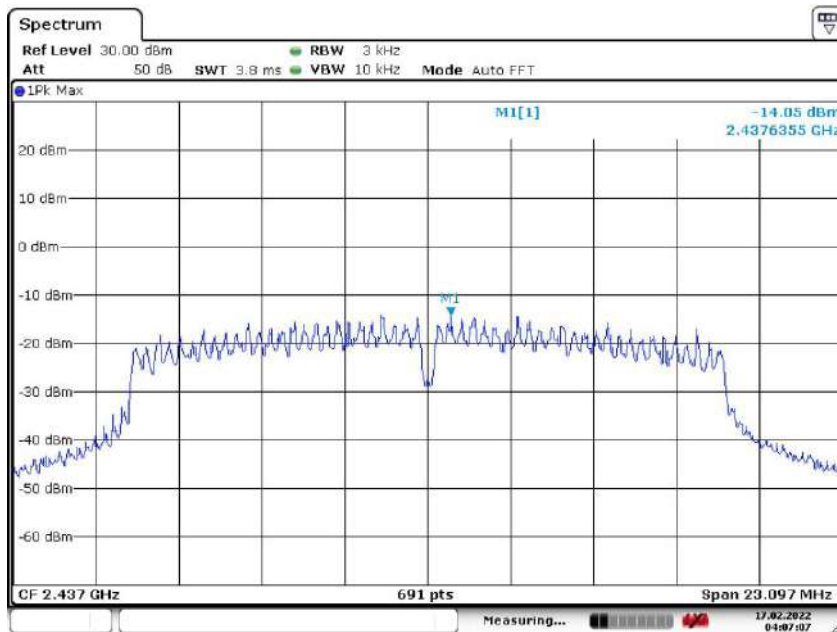

Channel 11: 2.462GHz:

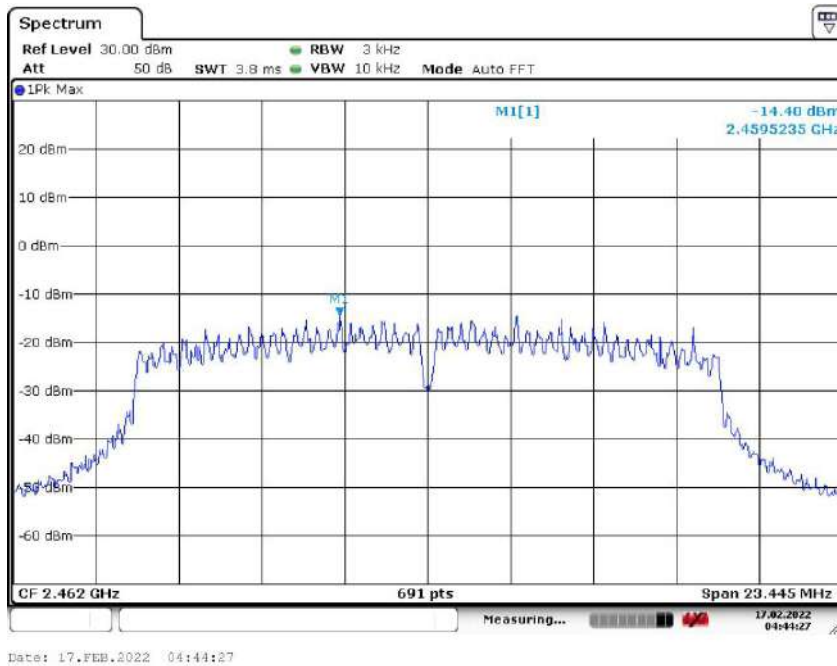

802.11n(HT20) mode with 72.2Mbps data rate

Channel 1: 2.412GHz:

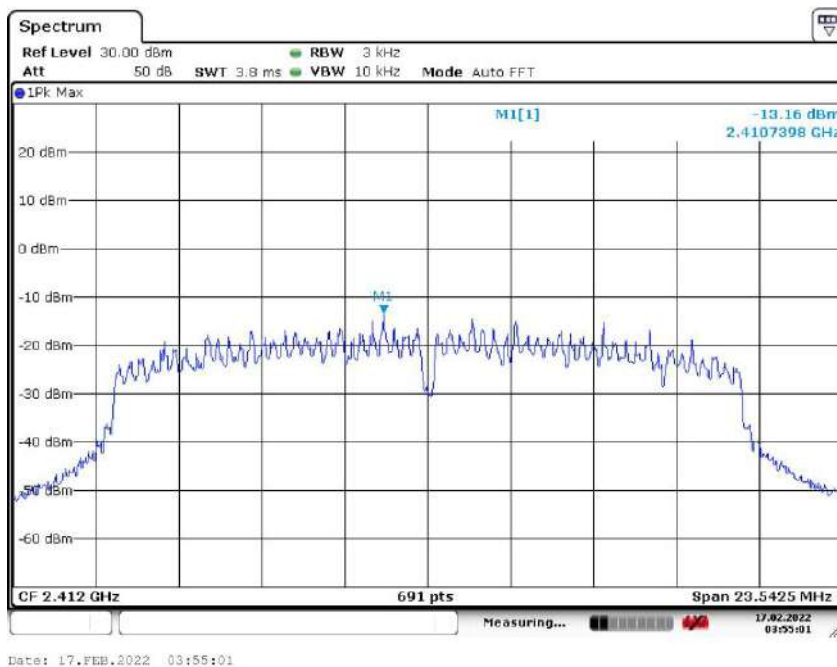

Channel 6: 2.437GHz:

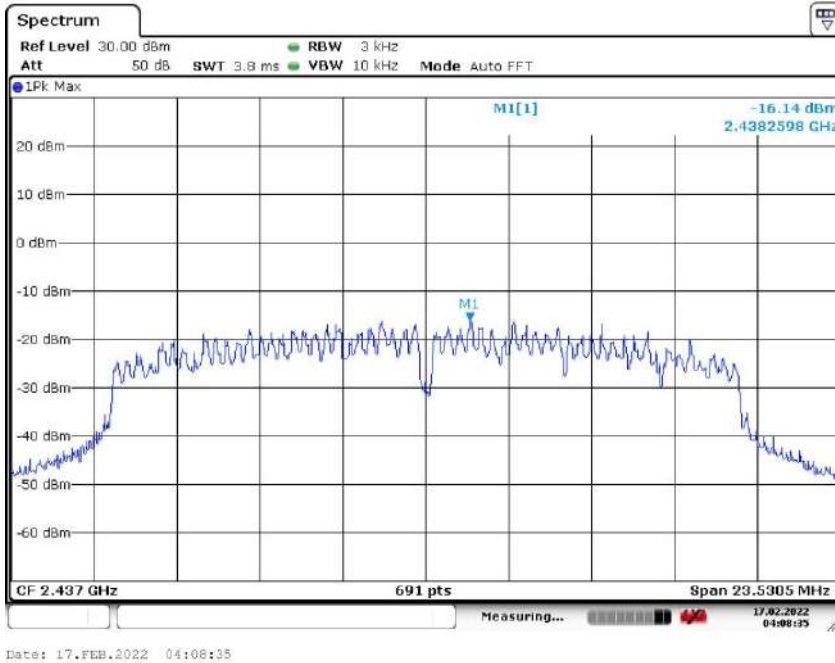

Channel 11: 2.462GHz:

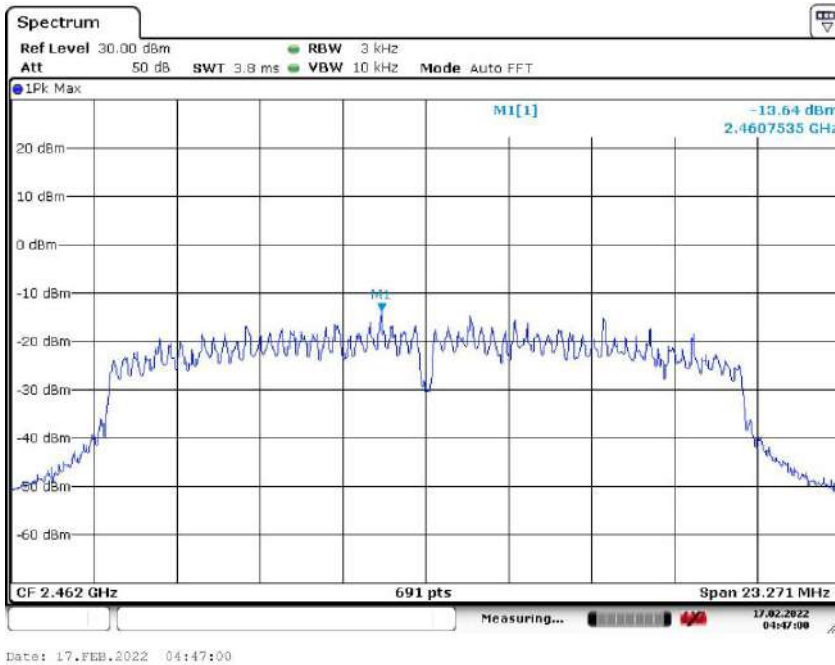

802.11n(HT40) mode with 150Mbps data rate

Channel 3: 2.422GHz:

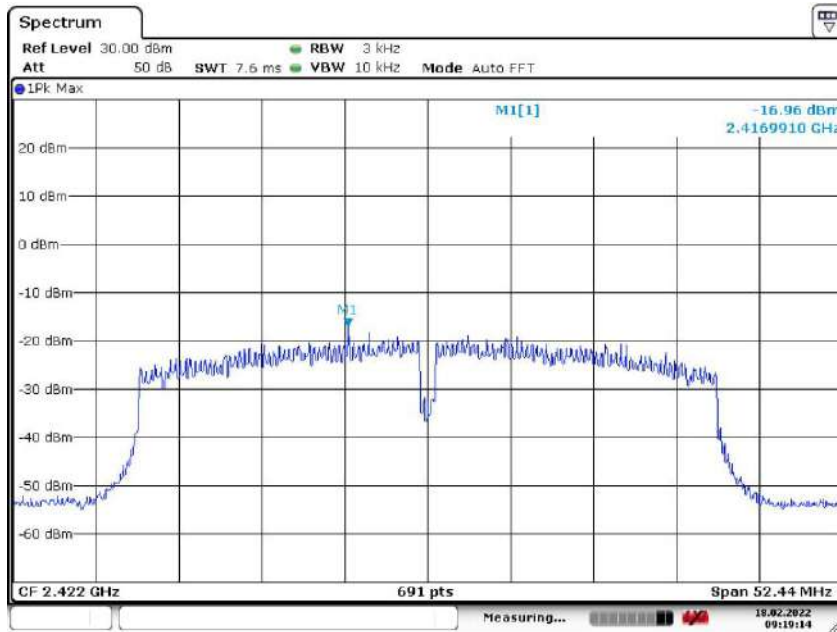

Date: 18.FEB.2022 09:19:15

Channel 6: 2.437GHz:

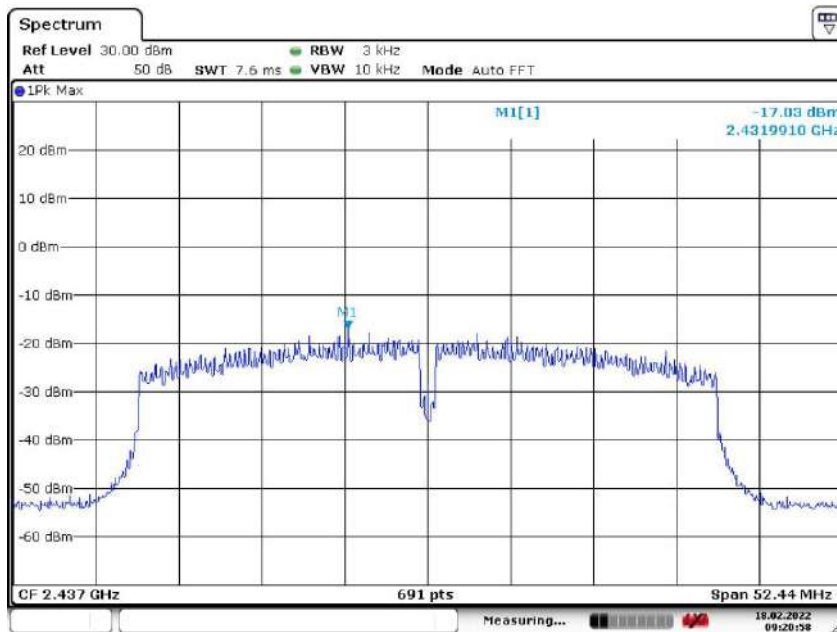

Date: 18.FEB.2022 09:20:59

Channel 9: 2.452GHz:

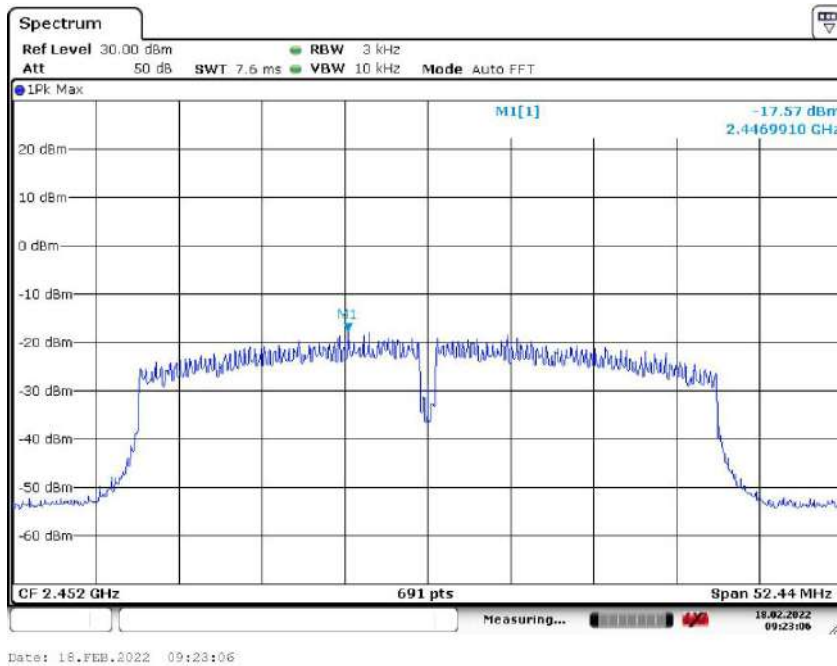

Result plot as follows: ANT J4

802.11b mode with 11Mbps data rate

Channel 1: 2.412GHz:

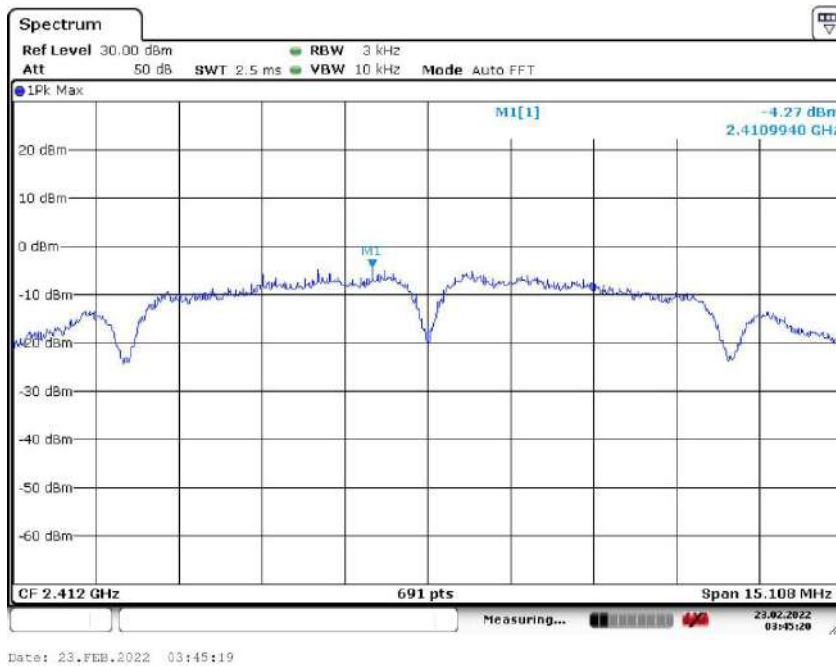

Channel 6: 2.437GHz:

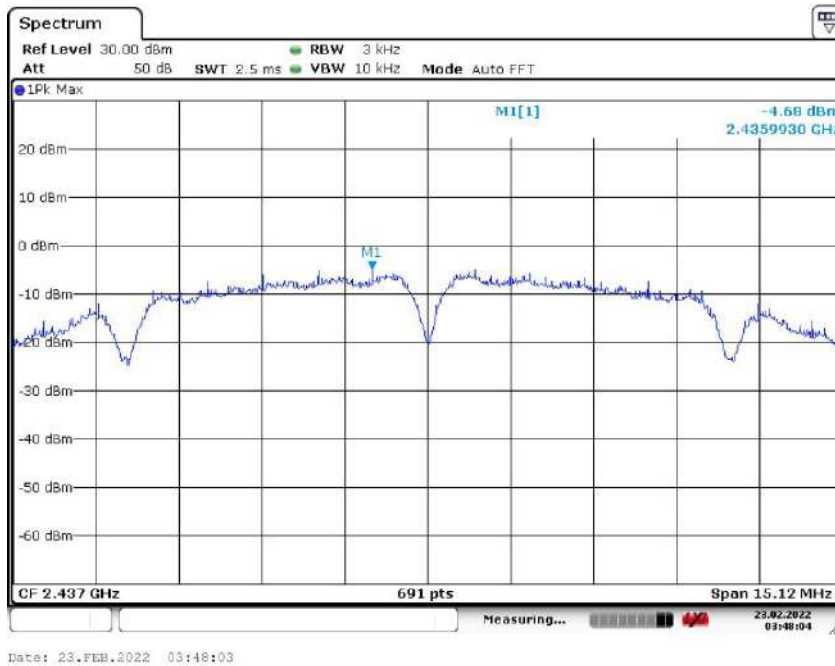

Channel 11: 2.462GHz:

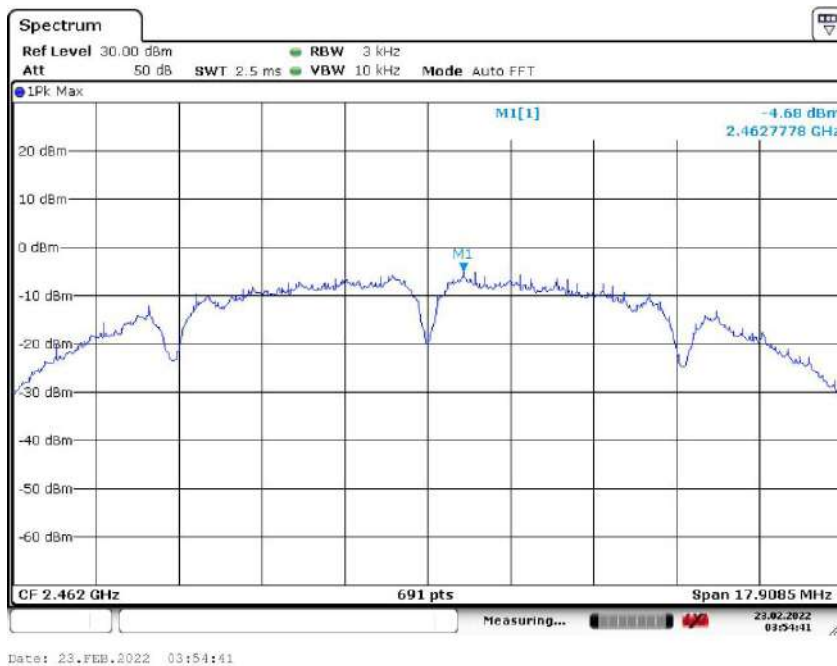

802.11g mode with 54Mbps data rate

Channel 1: 2.412GHz:

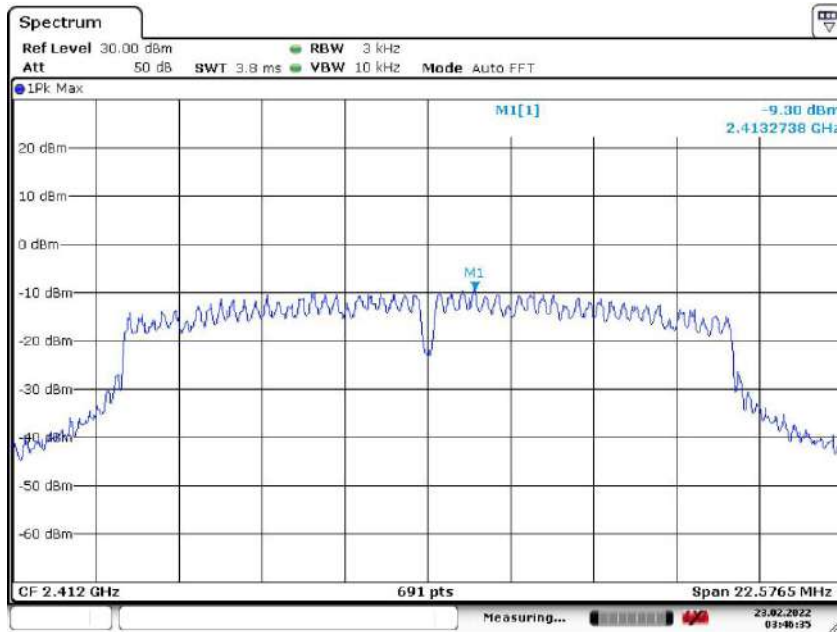

Date: 23.FEB.2022 03:46:34

Channel 6: 2.437GHz:

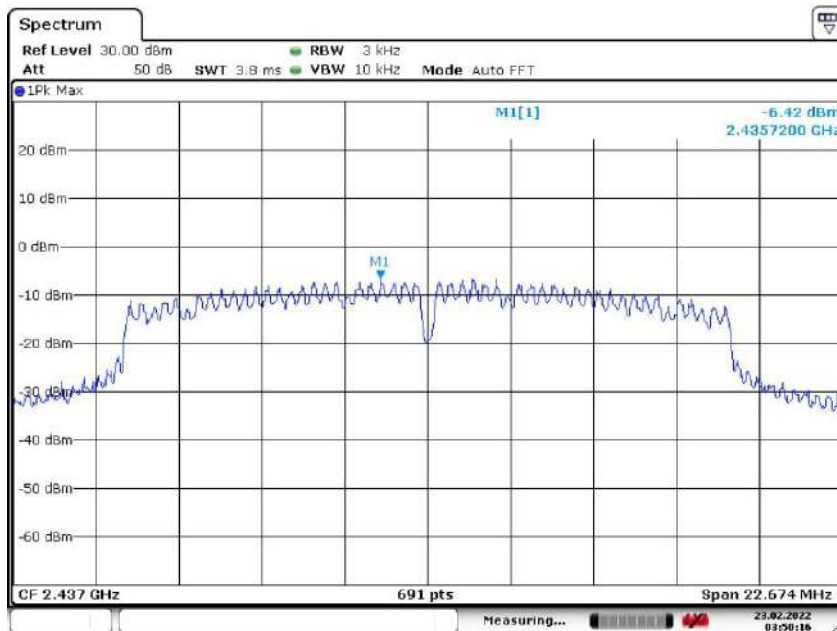

Date: 23.FEB.2022 03:50:16

Channel 11: 2.462GHz:

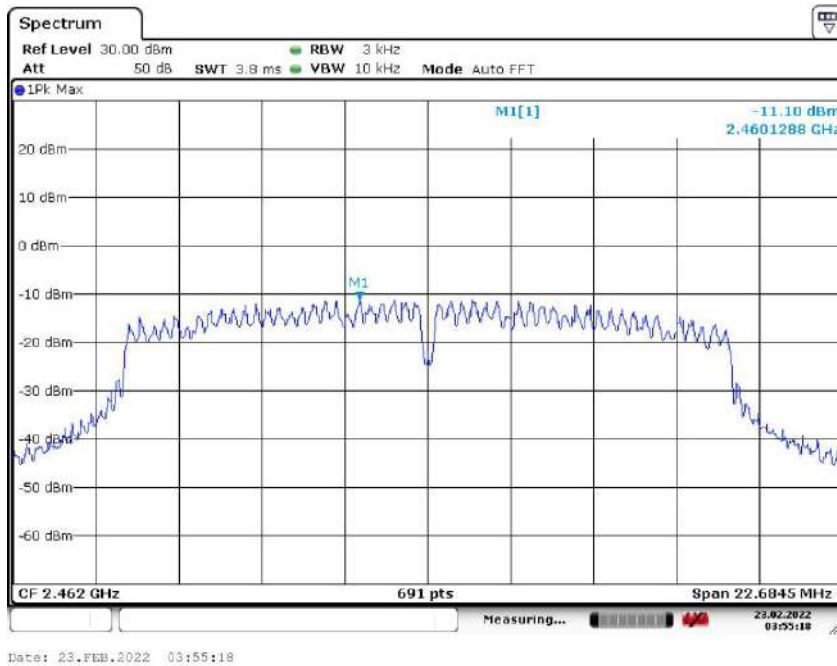

802.11n(HT20) mode with 72.2Mbps data rate

Channel 1: 2.412GHz:

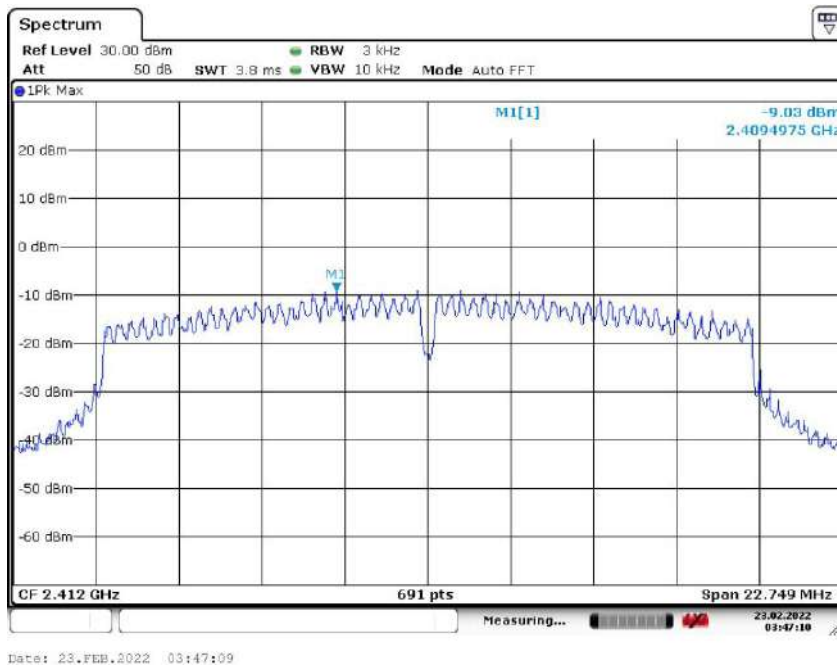

Channel 6: 2.437GHz:

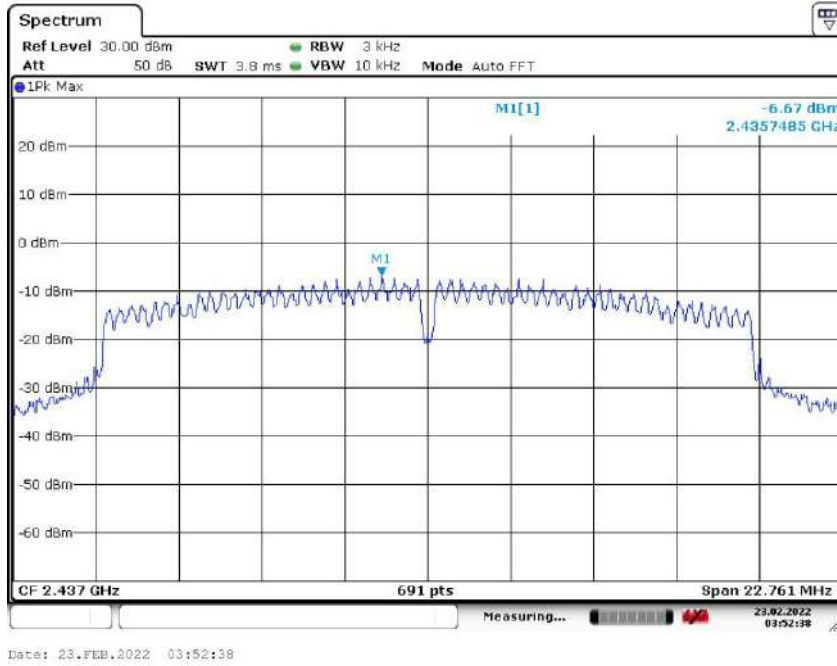

Channel 11: 2.462GHz:

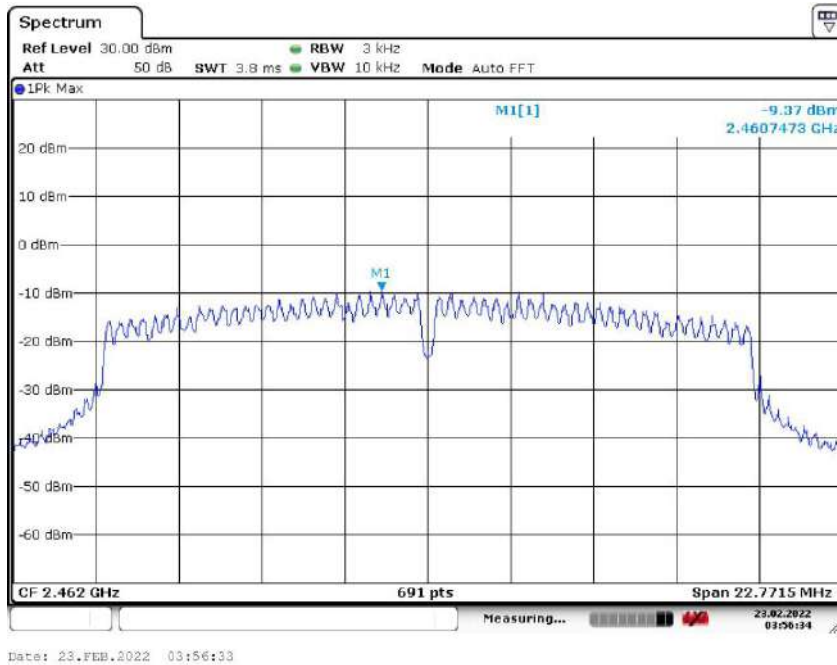

7.8 Band Edges Requirement

Test Requirement: FCC Part 15 C section 15.247

(d) In any 100 kHz bandwidth outside the frequency band in which the spread spectrum or digitally modulated intentional radiator is operating. The radio frequency power that is produced by the intentional radiator shall be at least 20 dB below that in the 100 kHz bandwidth within the band that contains the highest level of the desired power. Based on either an RF conducted or a radiated measurement. Provided the transmitter demonstrates compliance with the peak conducted power limits.

Frequency Band: 2400 MHz to 2483.5 MHz

Test Method: FCC/KDB-558074 D01 v03r01 Clause 13.3.1

Test Status: Pre-Scan has been conducted to determine the worst-case mode from all possible combinations between available modulations, data rates and antenna ports (if EUT with antenna diversity architecture). Following channel(s) was (were) selected for the final test as listed below.

Pre-test the EUT under 2 modes: power-supplied by using the AC adapter and power-supplied by using internal battery. After pre-testing, we found the worst case is the test mode of EUT power-supplied by using internal battery.

Test Configuration:

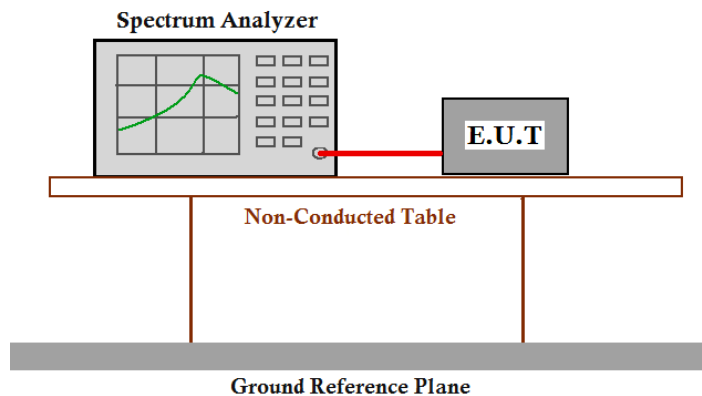

Test Procedure:

1. Remove the antenna from the EUT and then connect a low RF cable from the antenna port to the spectrum analyzer or power meter.
2. Set instrument center frequency to the frequency of the emission to be measured (must be within 2MHz of the authorized band edge).
3. Set span to 2MHz,
4. RBW=100kHz,
5. VBW \geq 3 \times RBW

6. Detector=peak
7. Sweep time =auto,
8. Trace mode=max hold.
9. Allow sweep to continue until the trace stabilizes(required measurement time may increase for low duty cycle applications)
10. Compute the power by integrating the spectrum over 1MHz using the analyzer's band power measurement function with band limits set equal to the emission frequency($f_{\text{emission}} \pm 0.5\text{MHz}$). If the instrument does not have a band power function, the sum the amplitude levels(in power units) at 100kHz intervals extending across the 1MHz spectrum defined by $f_{\text{emission}} \pm 0.5\text{MHz}$.

Test result with plots as follows: ANT J2

Compare with the output power of the lowest frequency, the Lower Edges attenuated more than 20dB

Compare with the output power of the highest frequency, the Upper Edges attenuated more than 20dB.

802.11b mode with 11Mbps data rate

Channel1: 2.412 GHz

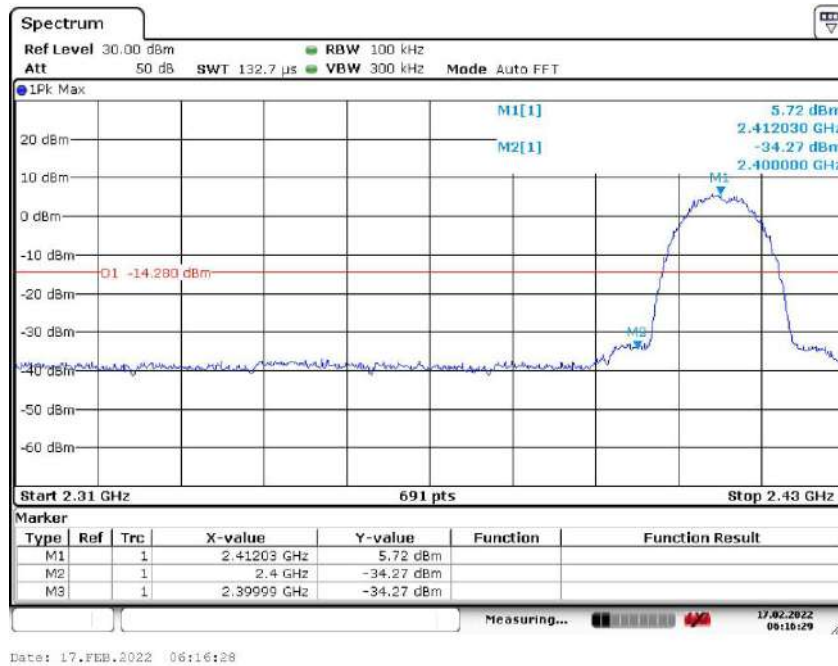

Date: 17.FEB.2022 06:16:28

802.11b mode with 11Mbps data rate

Channel11: 2.462 GHz

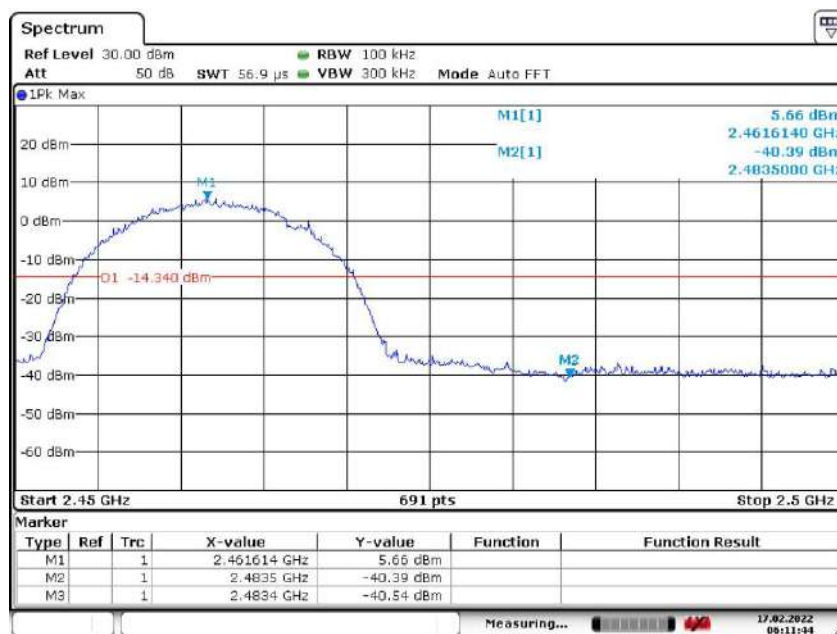

Date: 17.FEB.2022 06:11:44

802.11g mode with 54 Mbps data rate

Channel1: 2.412 GHz

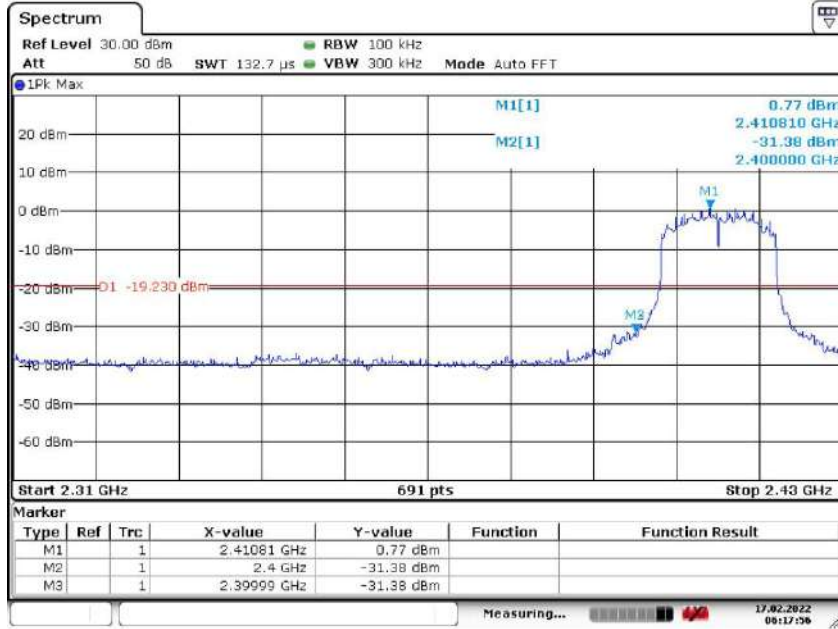

Date: 17.FEB.2022 06:17:56

802.11g mode with 54 Mbps data rate

Channel11: 2.462 GHz

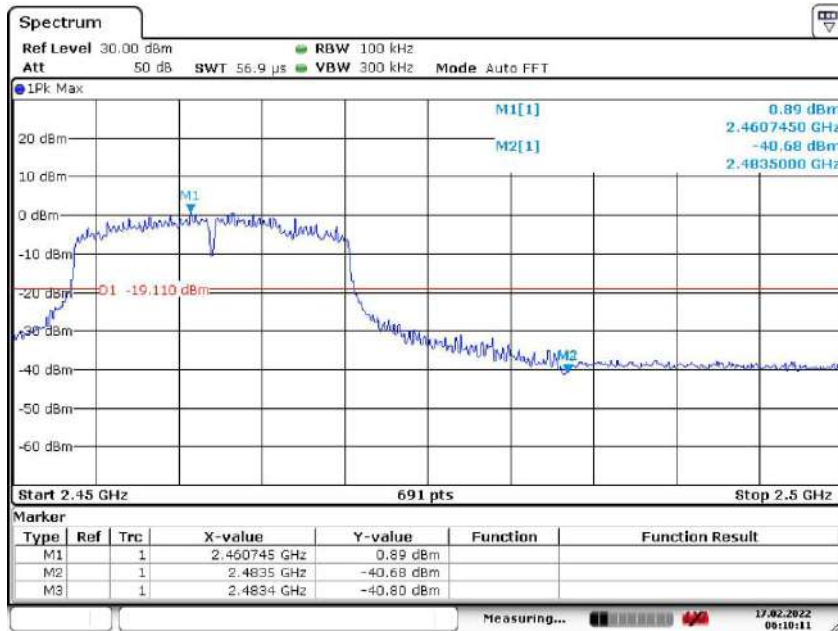

Date: 17.FEB.2022 06:10:11

802.11n(HT20) mode with 72.2Mbps data rate

Channel1: 2.412 GHz



802.11n(HT20) mode with 72.2Mbps data rate

Channel11: 2.462 GHz

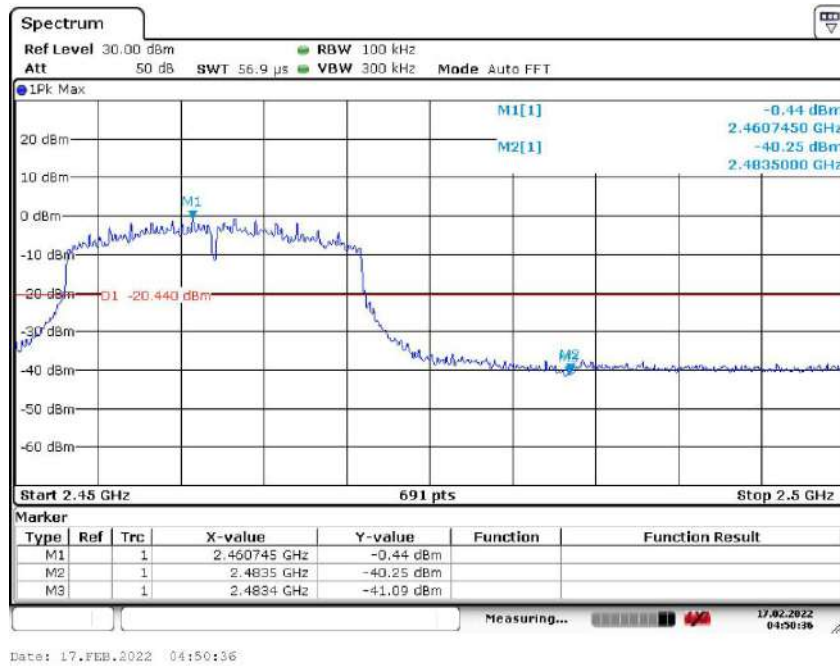

802.11n(HT40) mode with 150Mbps data rate

Channel 3: 2.422 GHz

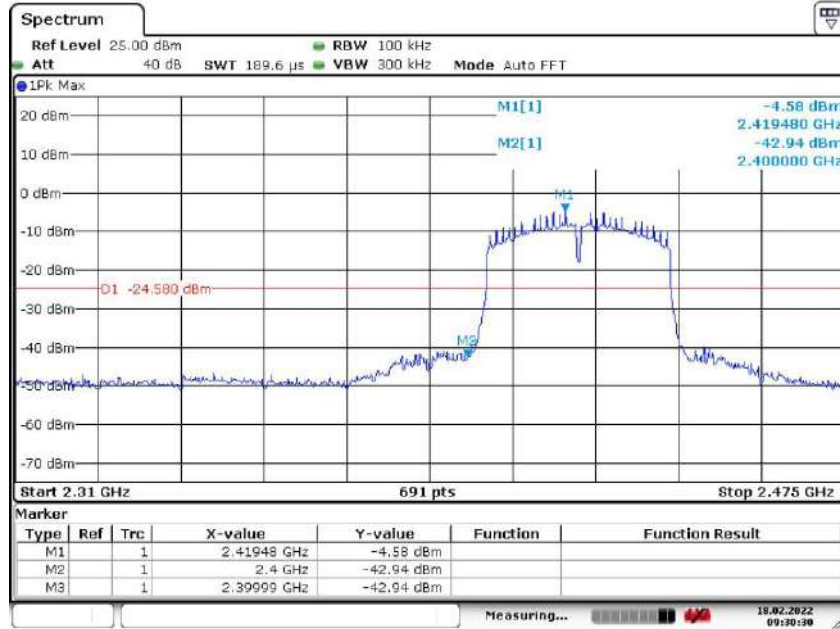

802.11n(HT40) mode with 150Mbps data rate

Channel 9: 2.452 GHz

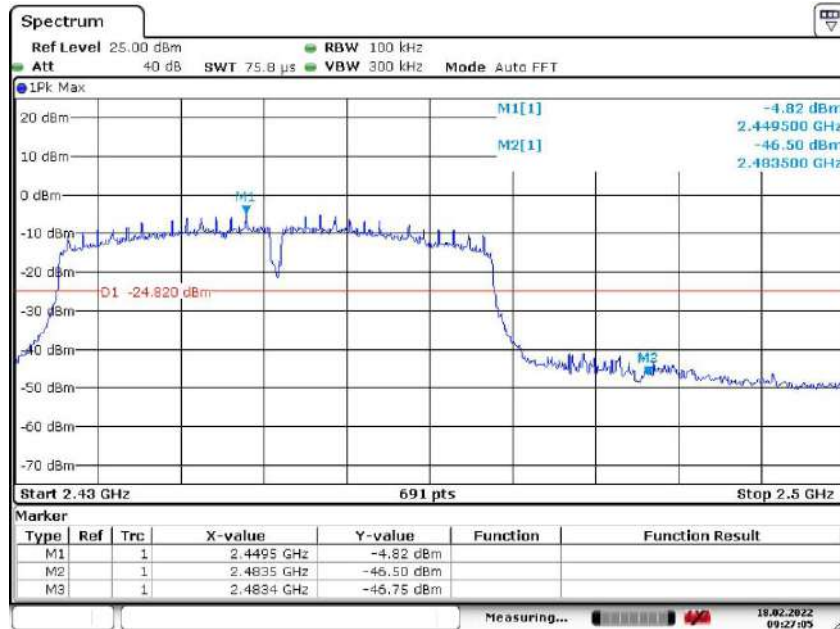

Test result with plots as follows: ANT J4

Compare with the output power of the lowest frequency, the Lower Edges attenuated more than 20dB

Compare with the output power of the highest frequency, the Upper Edges attenuated more than 20dB.

802.11b mode with 11Mbps data rate

Channel1: 2.412 GHz

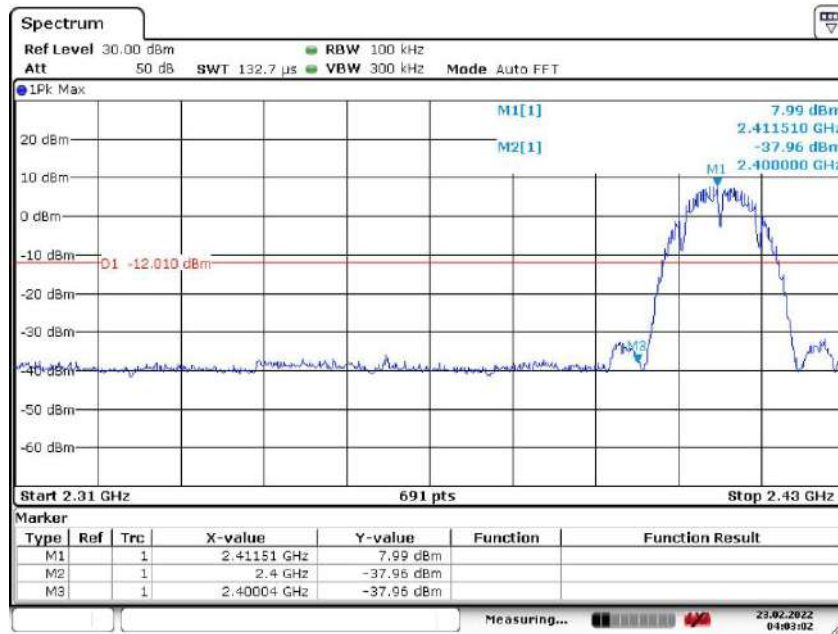

Date: 23.FEB.2022 04:03:01

802.11b mode with 11Mbps data rate

Channel11: 2.462 GHz

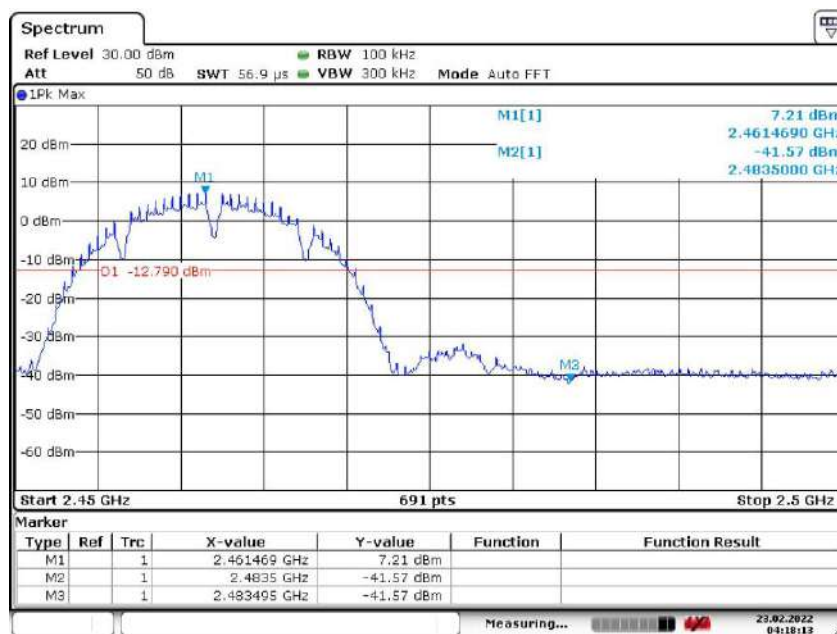

Date: 23.FEB.2022 04:18:12

802.11g mode with 54 Mbps data rate

Channel1: 2.412 GHz

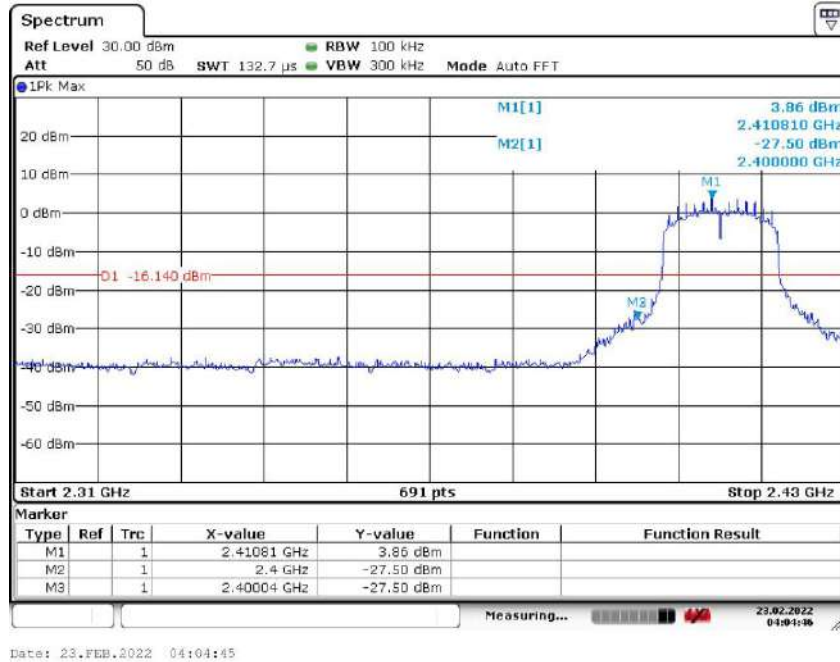

802.11g mode with 54 Mbps data rate

Channel11: 2.462 GHz

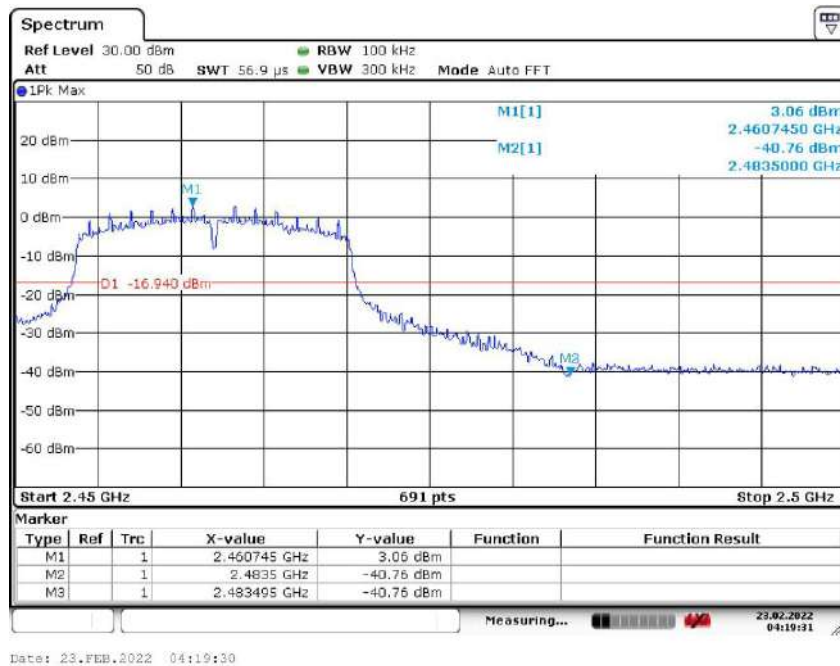

802.11n(HT20) mode with 72.2Mbps data rate

Channel1: 2.412 GHz



Date: 23.FEB.2022 04:16:22

802.11n(HT20) mode with 72.2Mbps data rate

Channel11: 2.462 GHz

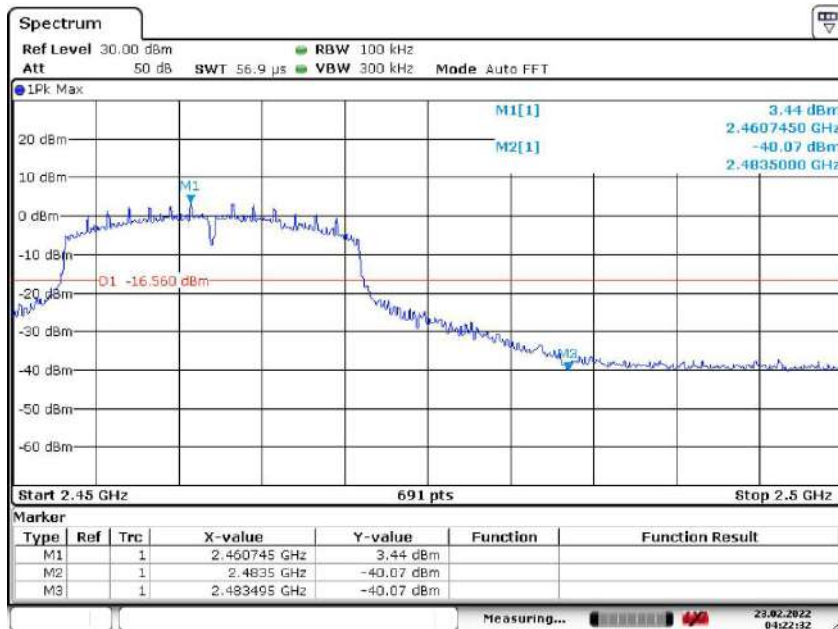

Date: 23.FEB.2022 04:22:32

7.9 Conducted Spurious Emissions

Test Requirement: FCC Part 15 C section 15.247

(d) In any 100 kHz bandwidth outside the frequency band in which the spread spectrum or digitally modulated intentional radiator is operating. the radio frequency power that is produced by the intentional radiator shall be at least 20 dB below that in the 100 kHz bandwidth within the band that contains the highest level of the desired power. Based on either an RF conducted or a radiated measurement. Provided the transmitter demonstrates compliance with the peak conducted power limits.

Test Method: ANSI C63.10: Clause 6.7

Test Status: Pre-Scan has been conducted to determine the worst-case mode from all possible combinations between available modulations, data rates and antenna ports (if EUT with antenna diversity architecture). Following channel(s) was (were) selected for the final test as listed below.

Pre-Test the EUT using external Standard DC power source for powering on the board.

Test Configuration:

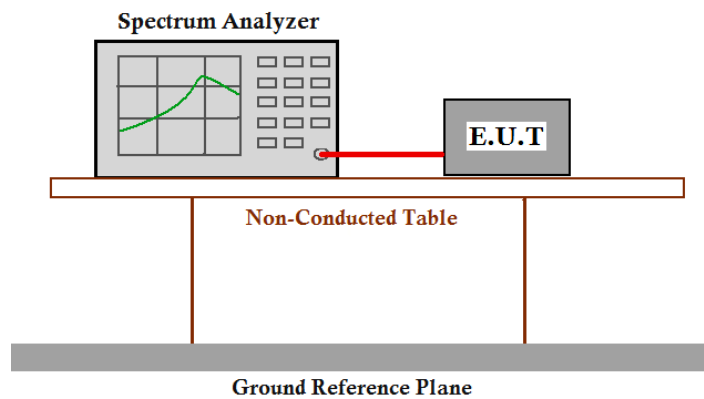

Test Procedure:

1. Remove the antenna from the EUT and then connect a low RF cable from the antenna port to the spectrum analyzer or power meter.
2. Set the spectrum analyzer: RBW=100 KHz, VBW = 300KHz. Sweep = auto; Detector Function = Peak. Trace = Max Hold, Scan up through 10th harmonic.
3. Measure the Conducted Spurious Emissions of the test frequency with special test status.
4. Repeat until all the test status is investigated.
5. Report the worse case.

Result plot as follows: ANT J2

802.11b mode with 11Mbps data rate

Channel 1: 2.412GHz:

30 MHz to 1 GHz

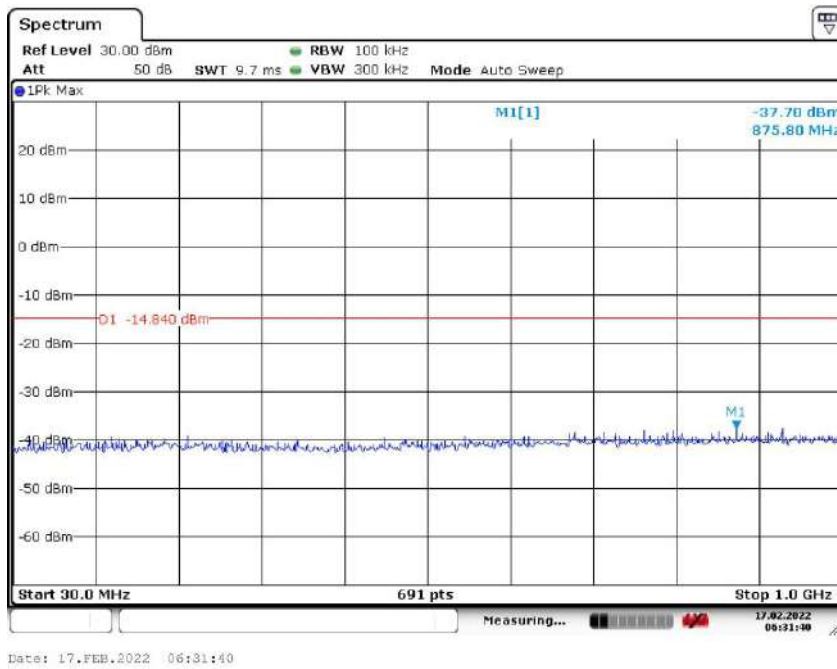

1 G to 3 GHz

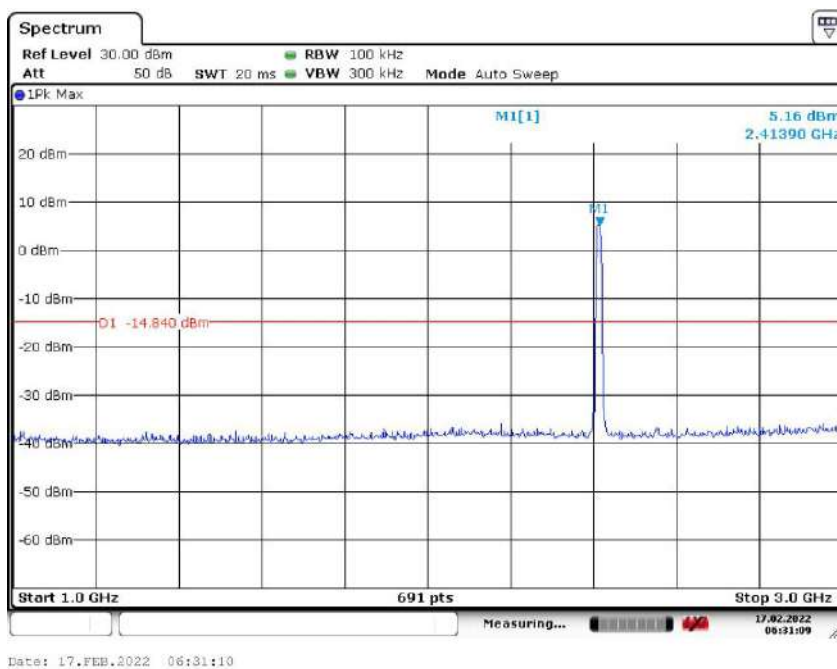

3 G to 13 GHz

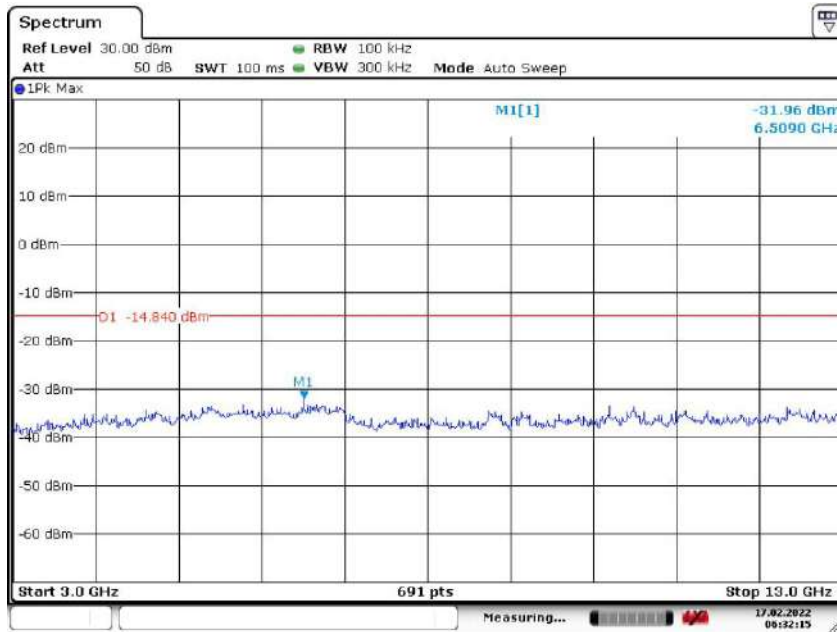

Date: 17.FEB.2022 06:32:15

13 G to 25 GHz

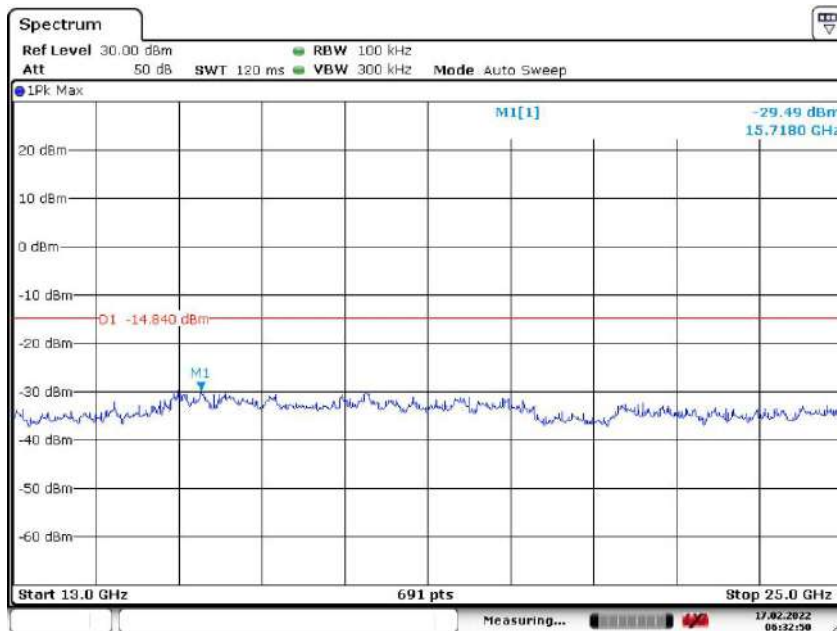

Date: 17.FEB.2022 06:32:50

Channel 6: 2.437GHz:

30 MHz to 1 GHz

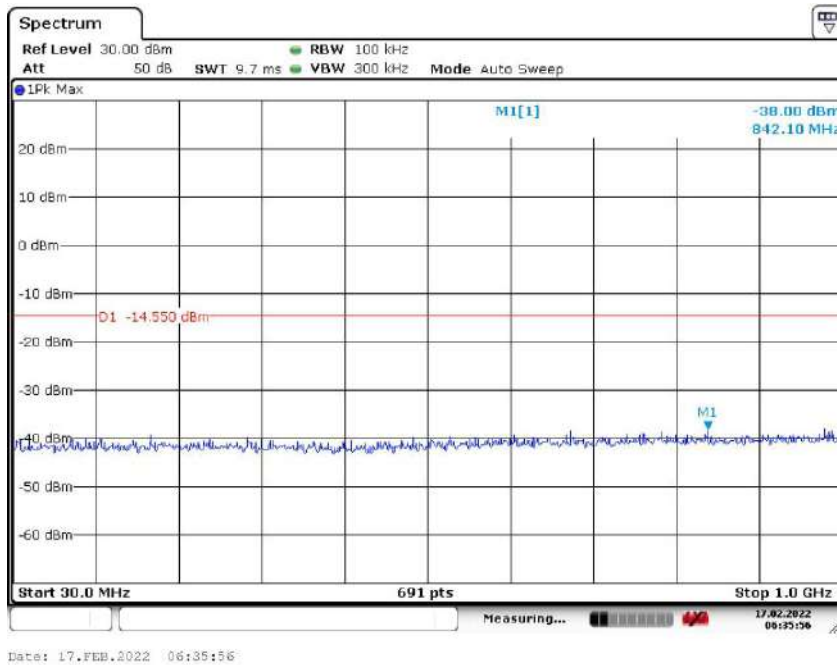

1 G to 3 GHz

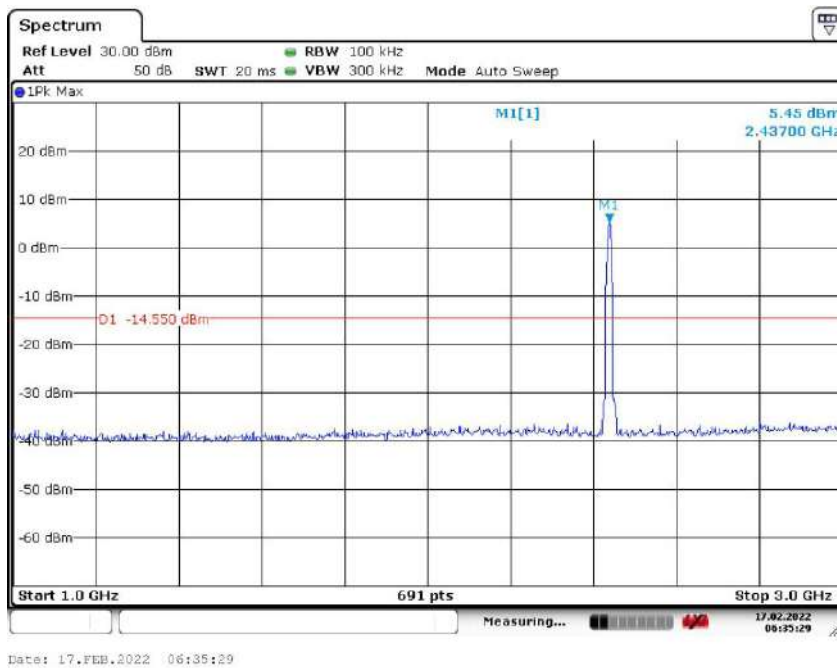

3 G to 13 GHz

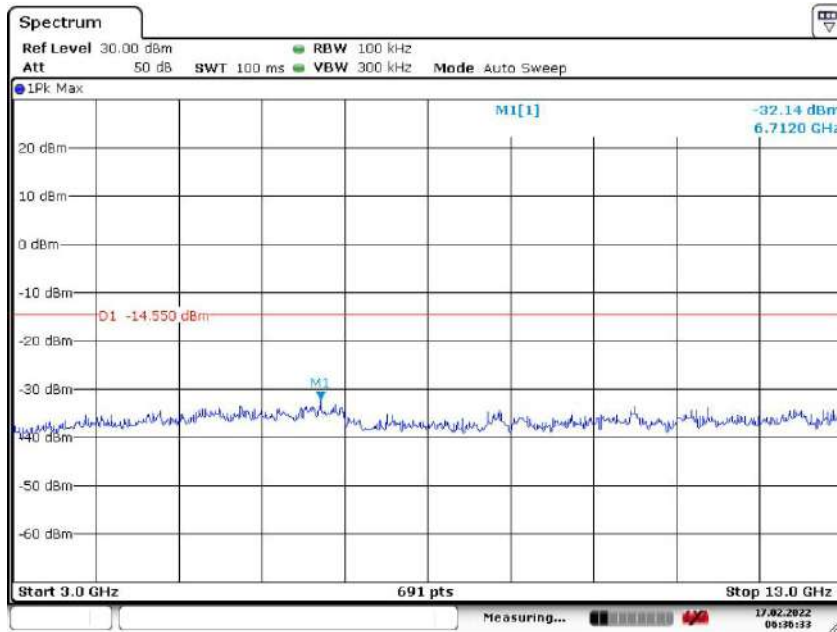

Date: 17.FEB.2022 06:36:33

13 G to 25 GHz

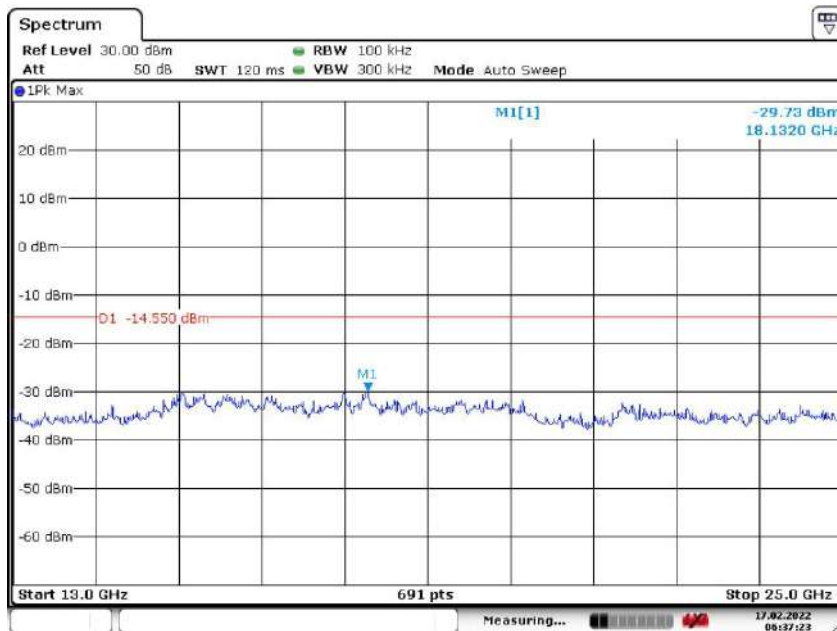

Date: 17.FEB.2022 06:37:23

Channel 11:2.462 GHz

30 MHz to 1 GHz

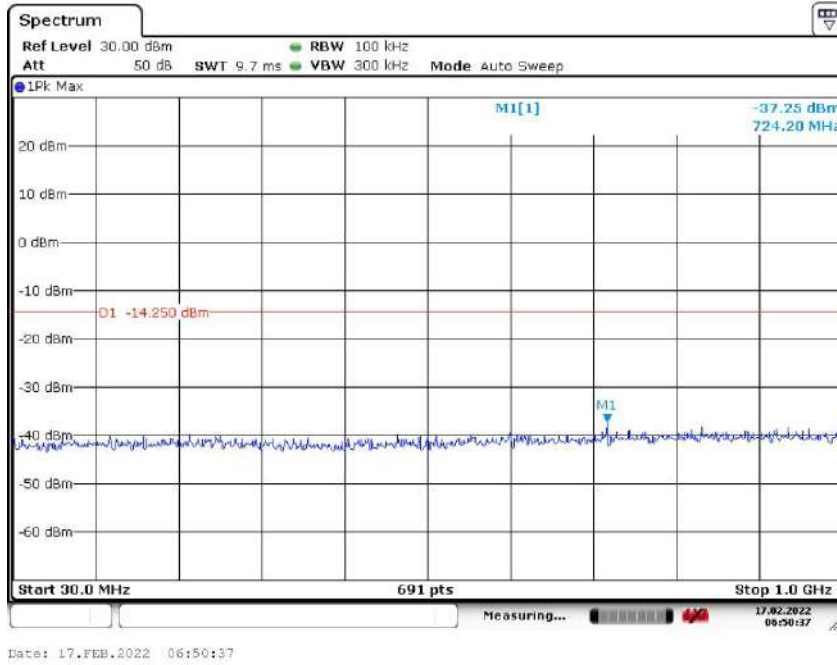

1 G to 3 GHz

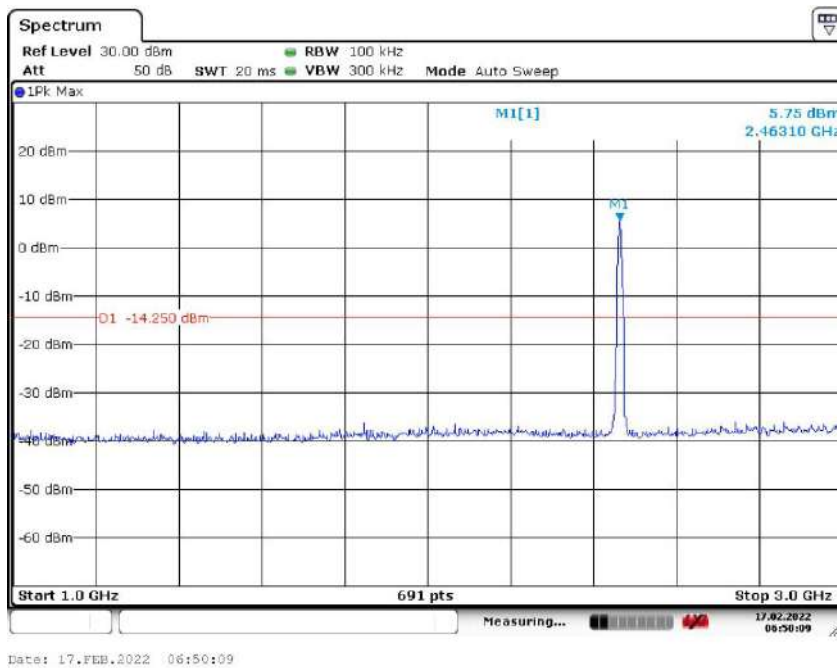

3 G to 13 GHz

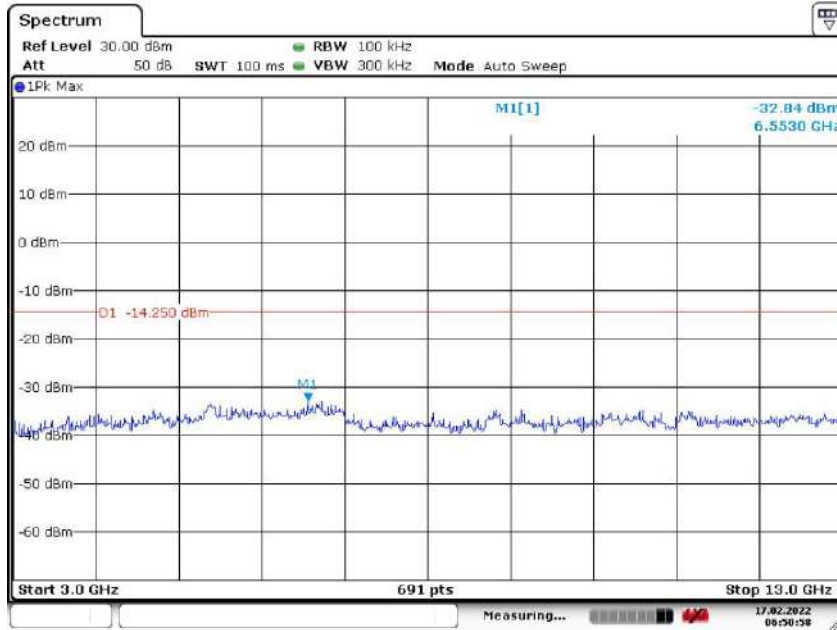

Date: 17.FEB.2022 06:50:59

13 G to 25 GHz

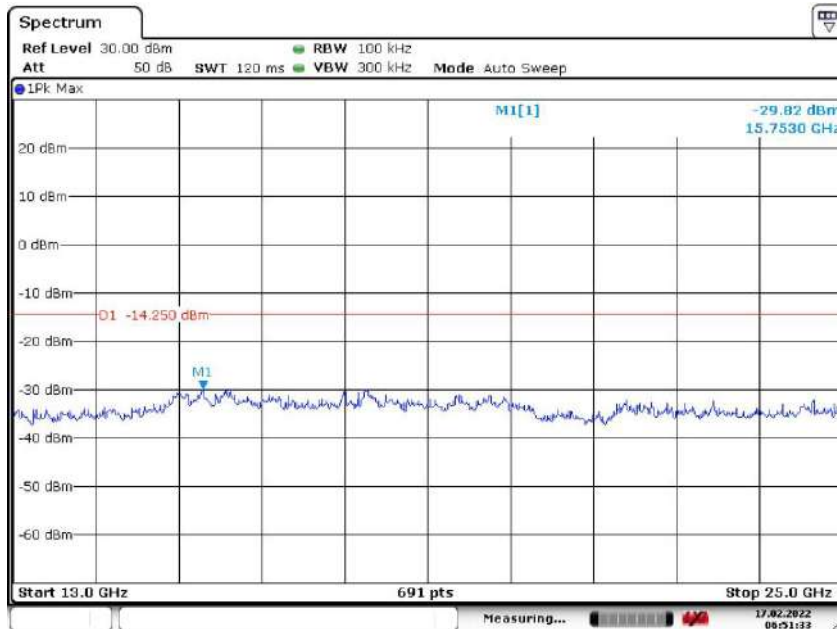

Date: 17.FEB.2022 06:51:33

802.11g mode with 54Mbps data rate

Channel 1: 2.412GHz:

30 MHz to 1 GHz

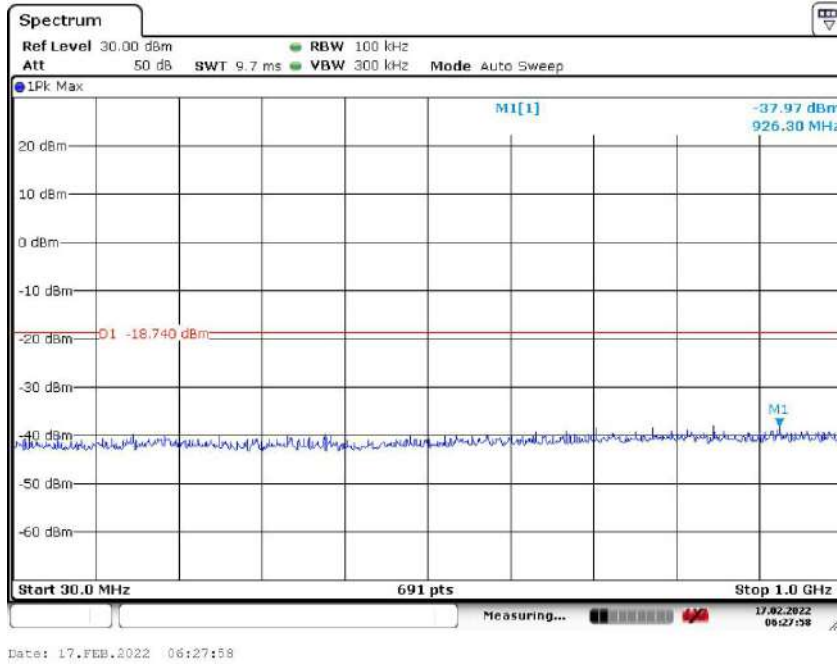

1 G to 3 GHz

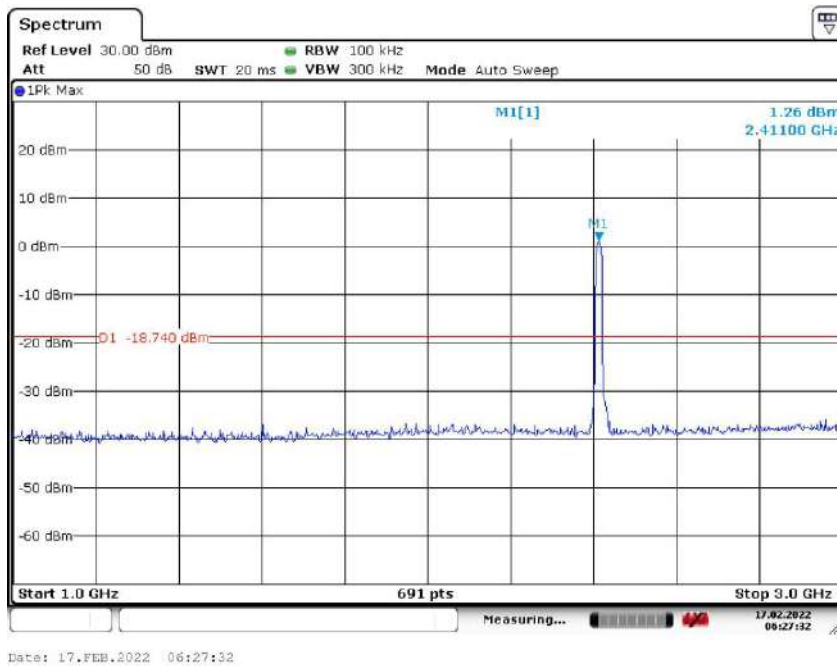

3 G to 13 GHz

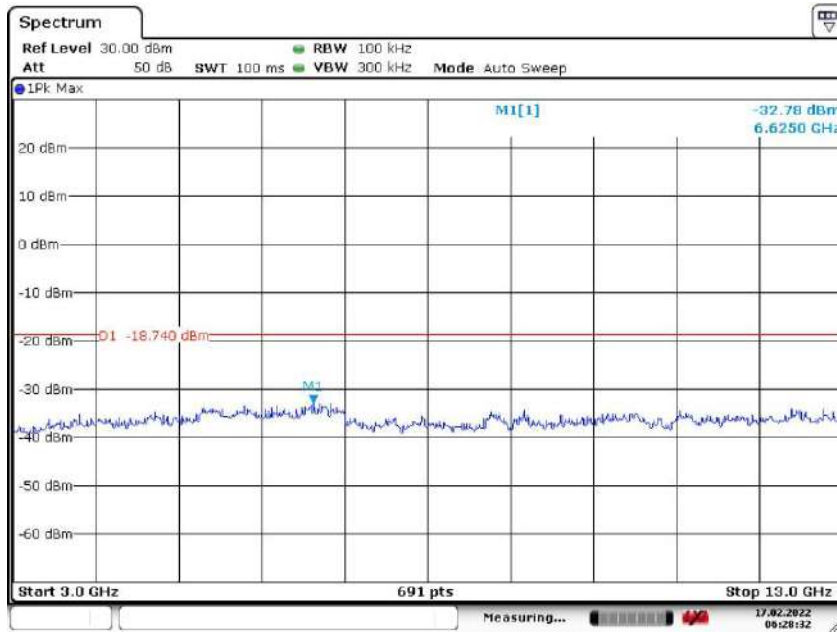

Date: 17.FEB.2022 06:28:32

13 G to 25 GHz

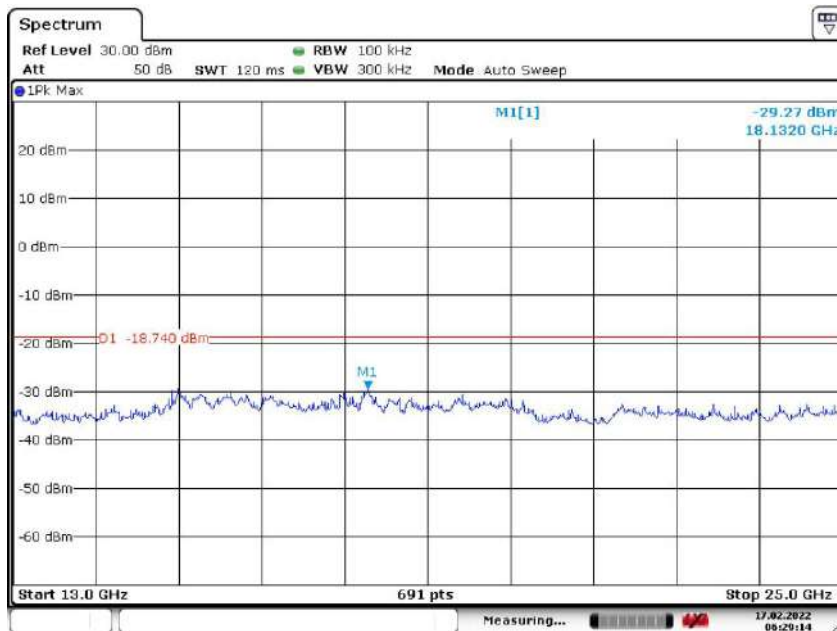

Date: 17.FEB.2022 06:29:14

Channel 6: 2.437GHz:

30 MHz to 1 GHz

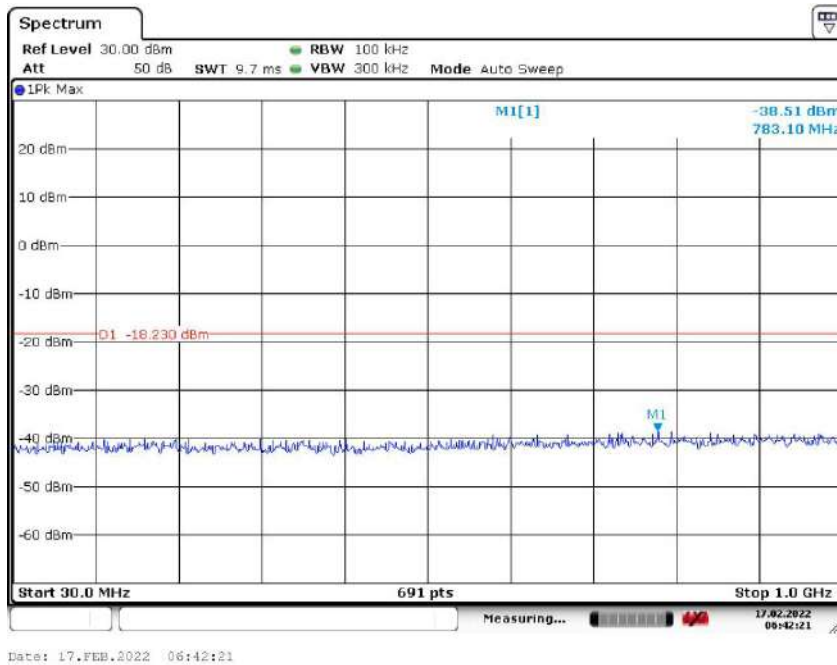

1 G to 3 GHz

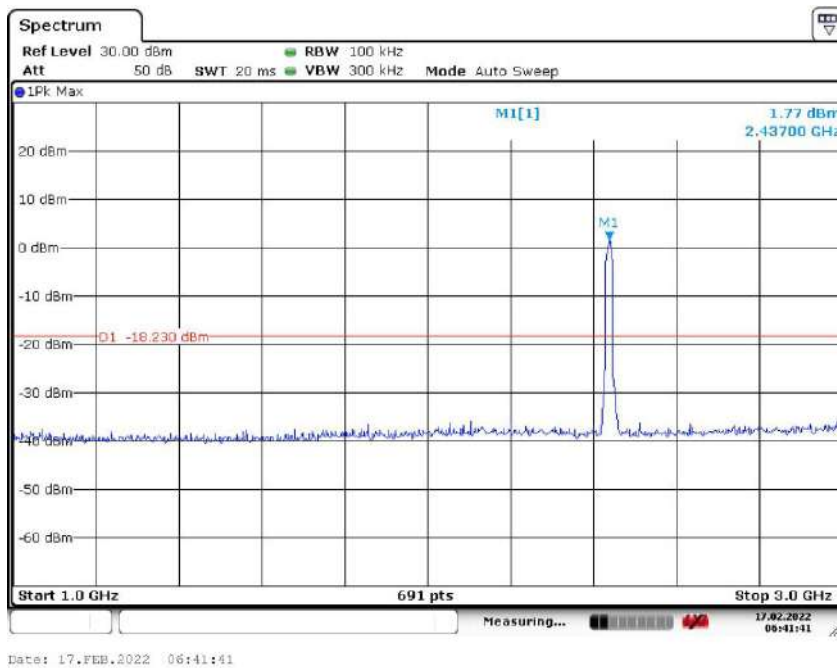

3 G to 13 GHz

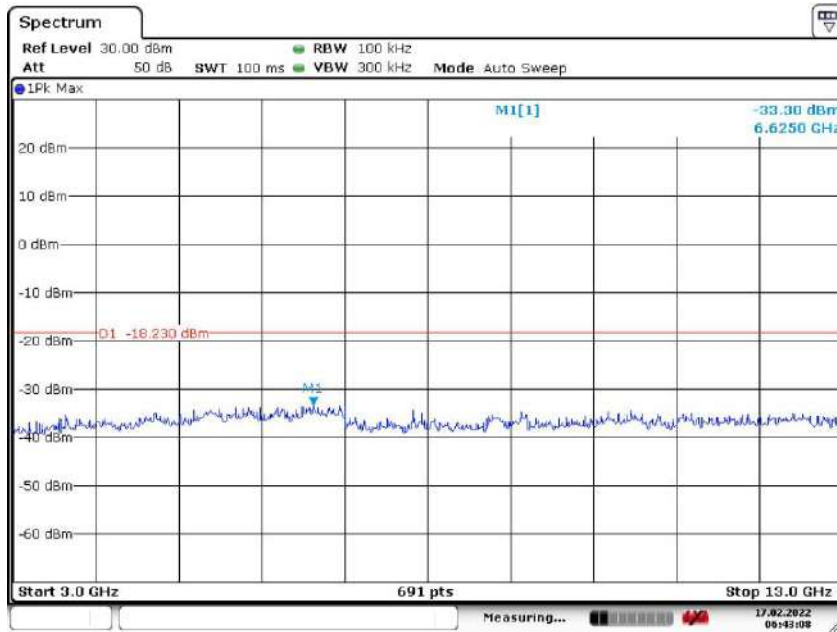

Date: 17.FEB.2022 06:43:09

13 G to 25 GHz

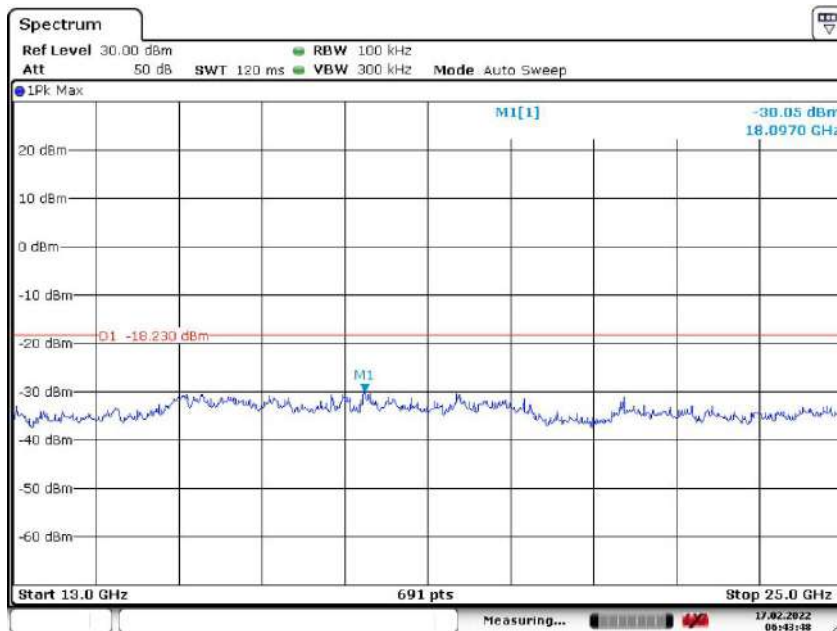

Date: 17.FEB.2022 06:43:48

Channel 11:2.462 GHz

30 MHz to 1 GHz

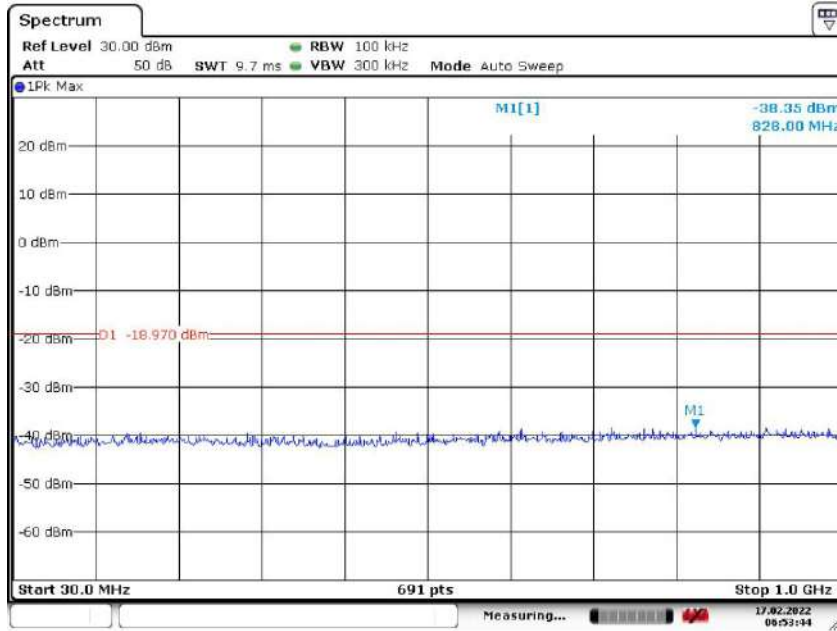

Date: 17.FEB.2022 06:53:44

1 G to 3 GHz

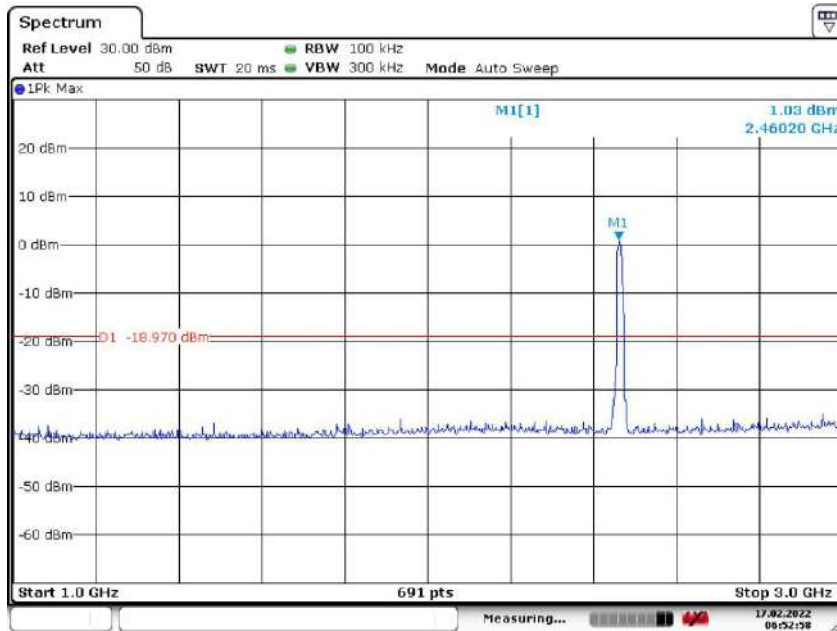

Date: 17.FEB.2022 06:52:58

3 G to 13 GHz

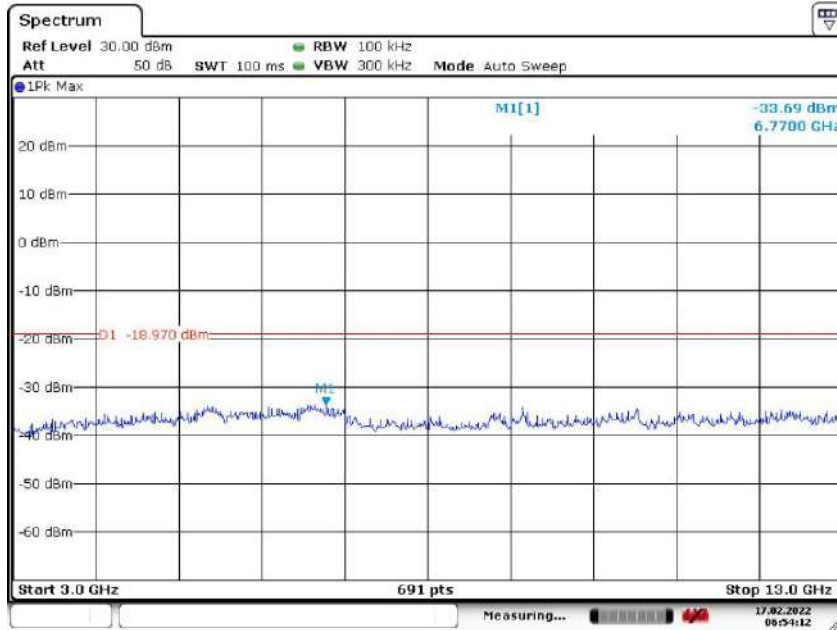

Date: 17.FEB.2022 06:54:12

13 G to 25 GHz

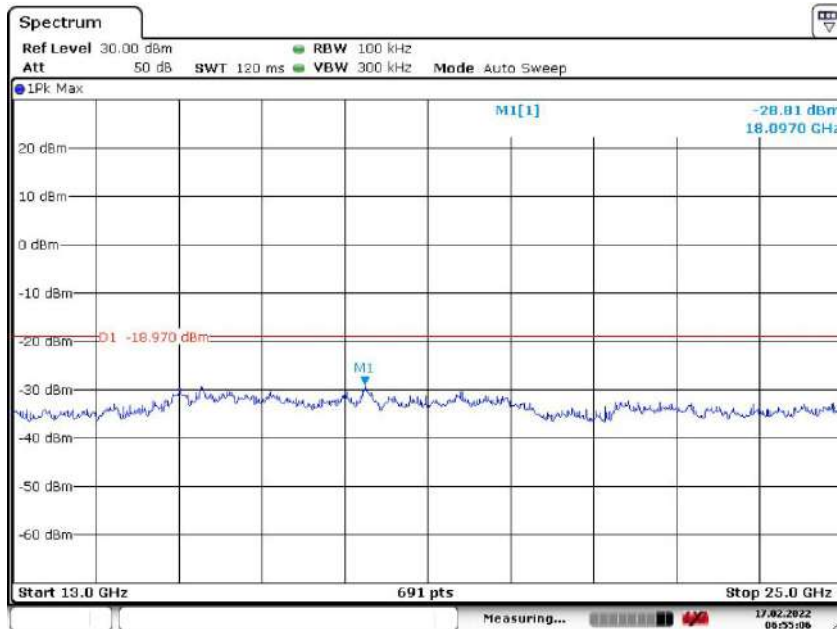

Date: 17.FEB.2022 06:55:06

802.11n(HT20) mode with 72.2Mbps data rate

Channel 1: 2.412GHz:

30 MHz to 1 GHz

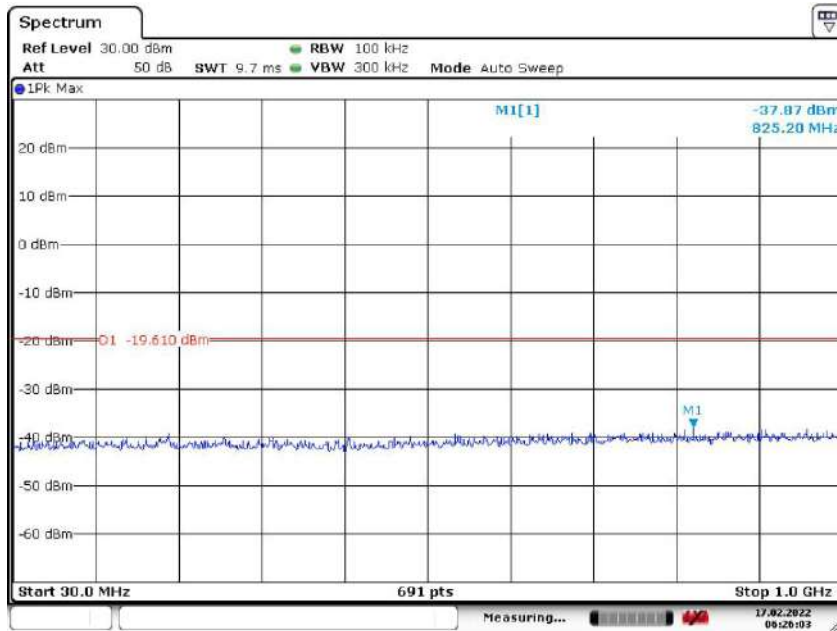

Date: 17.FEB.2022 06:26:03

1 G to 3 GHz

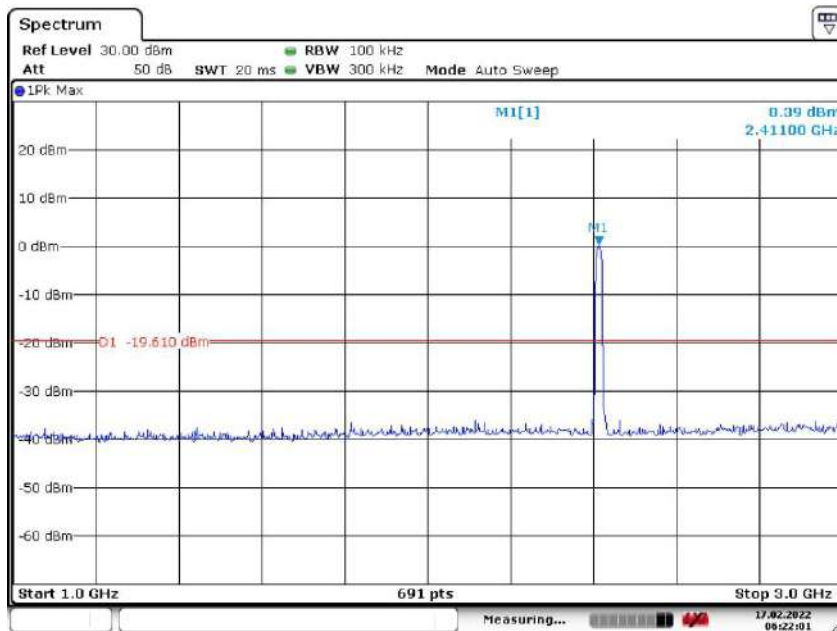

Date: 17.FEB.2022 06:22:01

3 G to 13 GHz

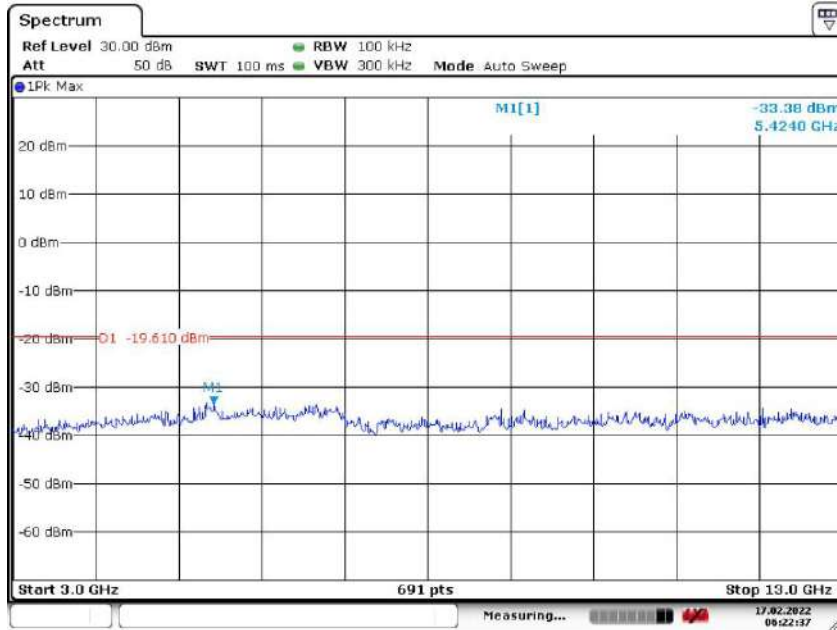

Date: 17.FEB.2022 06:22:37

13 G to 25 GHz

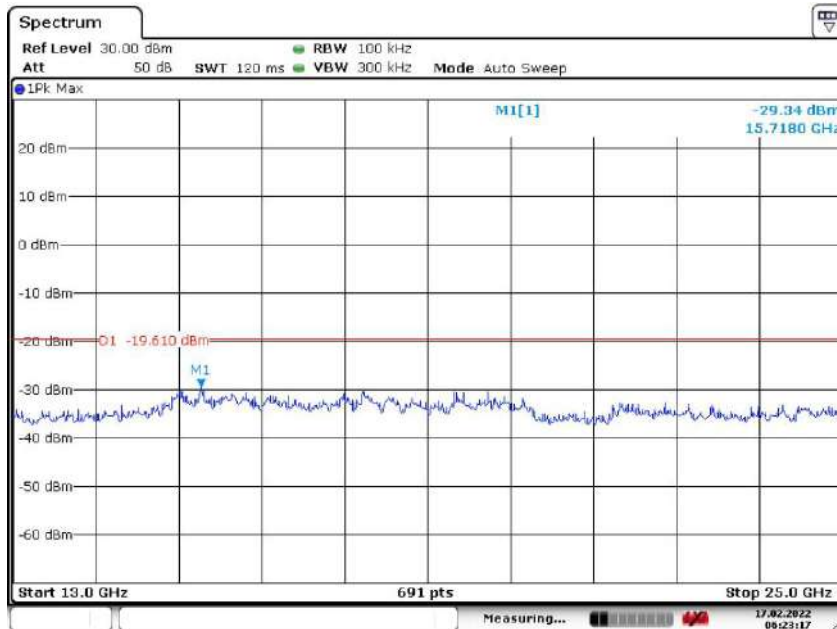

Date: 17.FEB.2022 06:23:17

Channel 6: 2.437GHz:

30 MHz to 1 GHz

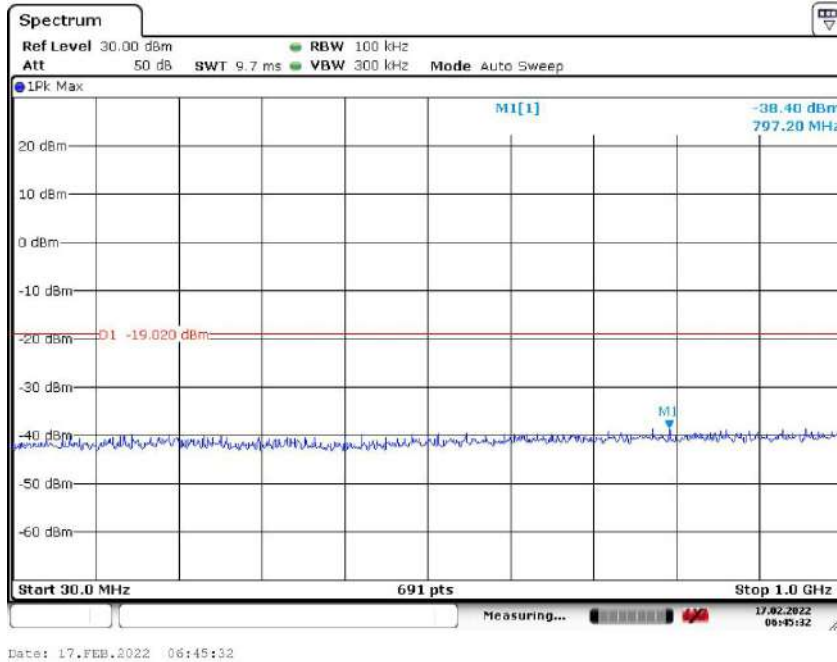

1 G to 3 GHz

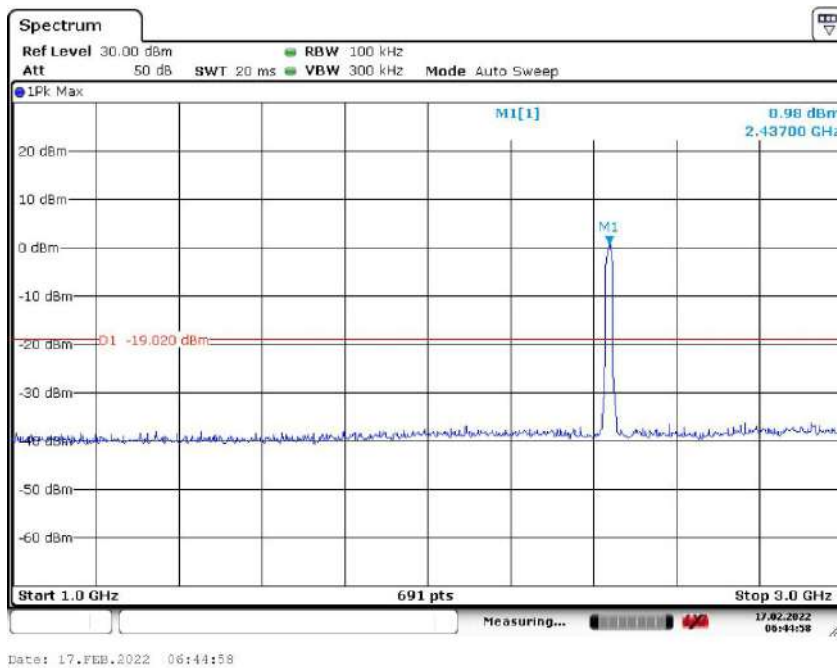

3 G to 13 GHz

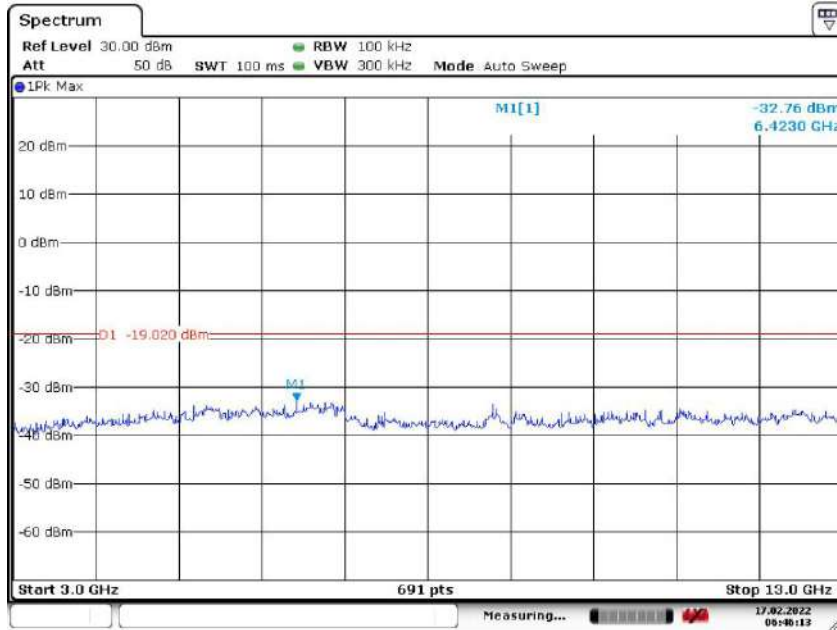

Date: 17.FEB.2022 06:46:13

13 G to 25 GHz

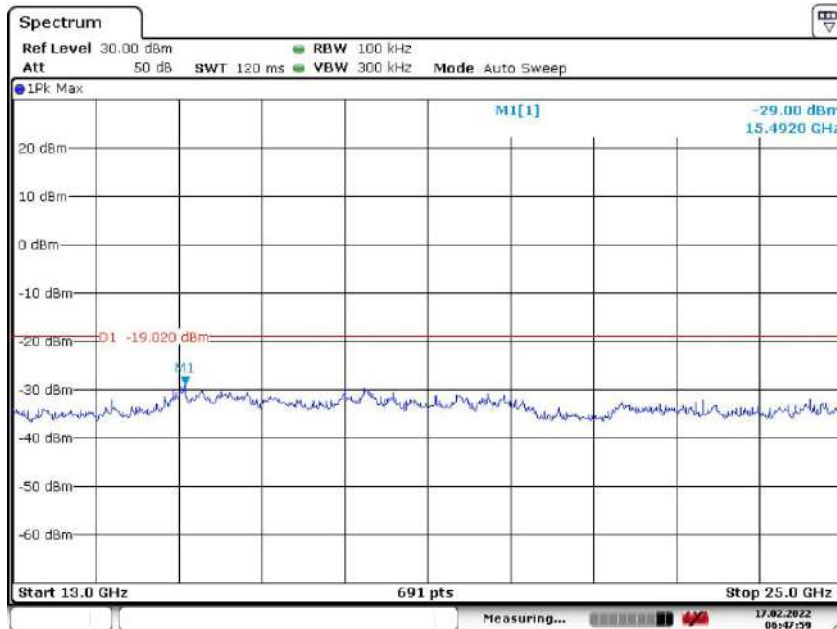

Date: 17.FEB.2022 06:47:59

Channel 11:2.462 GHz

30 MHz to 1 GHz

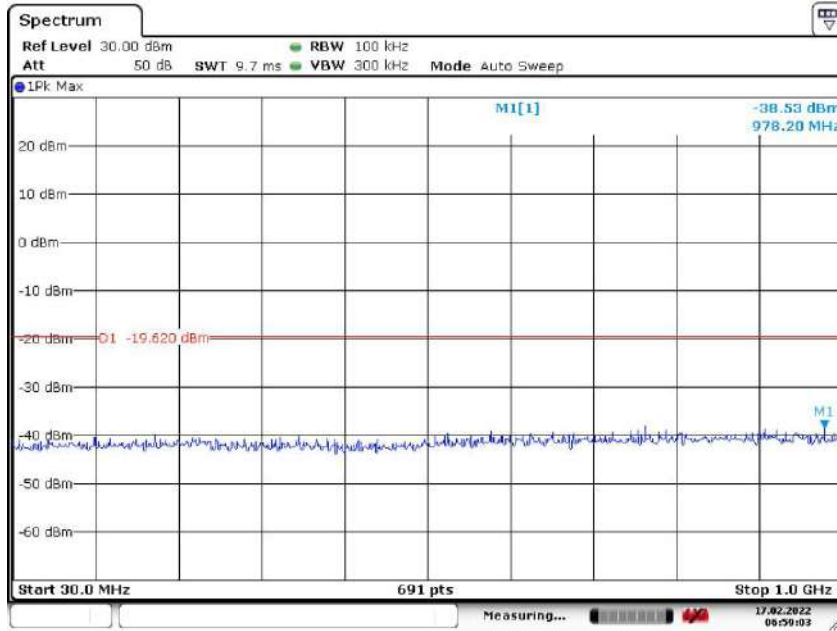

1 G to 3 GHz

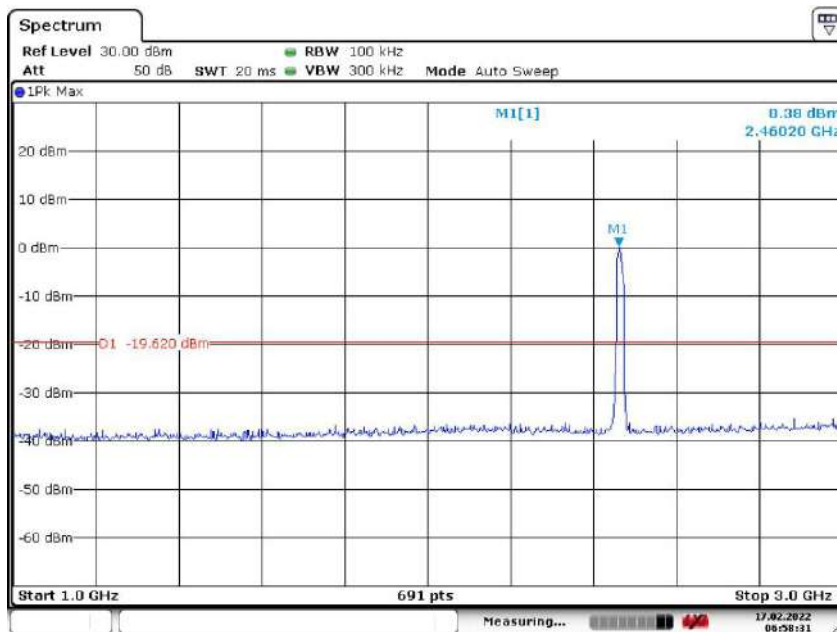

3 G to 13 GHz

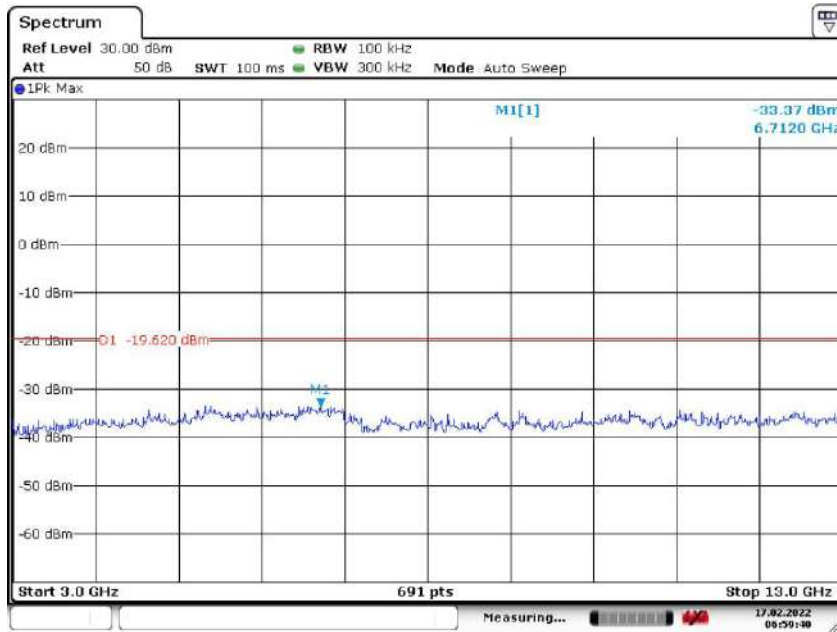

Date: 17.FEB.2022 06:59:40

13 G to 25 GHz

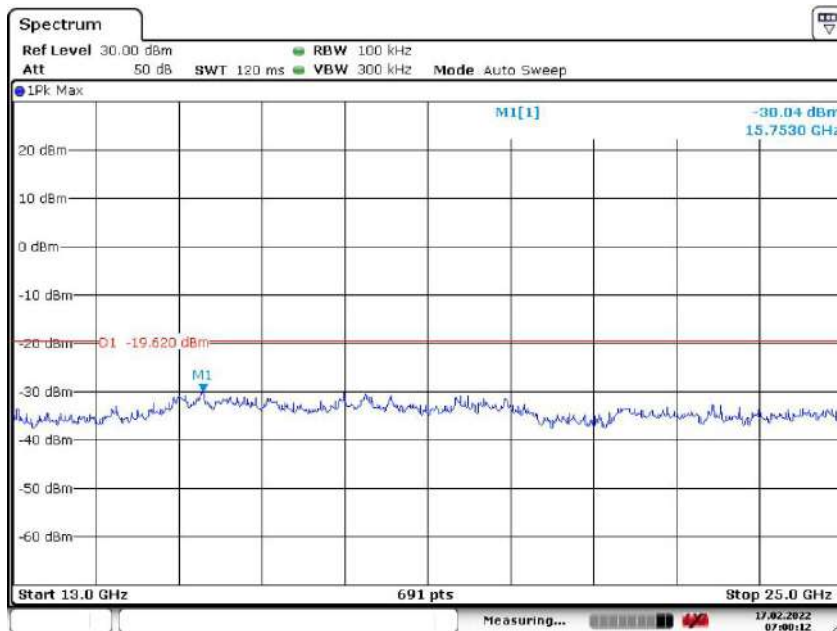

Date: 17.FEB.2022 07:00:12

802.11n(HT40) mode with 150Mbps data rate

Channel 3: 2.422GHz:

30 MHz to 1 GHz

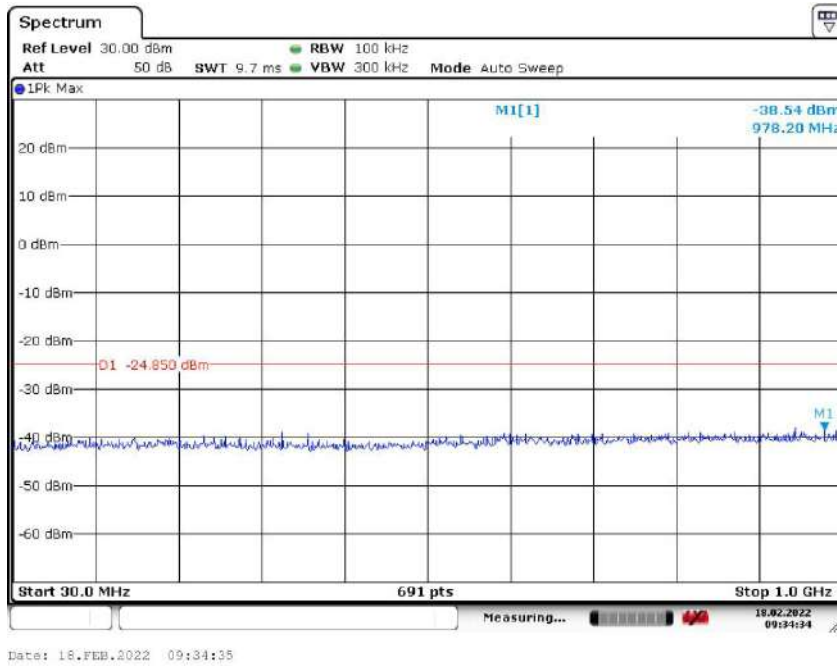

1 G to 3 GHz

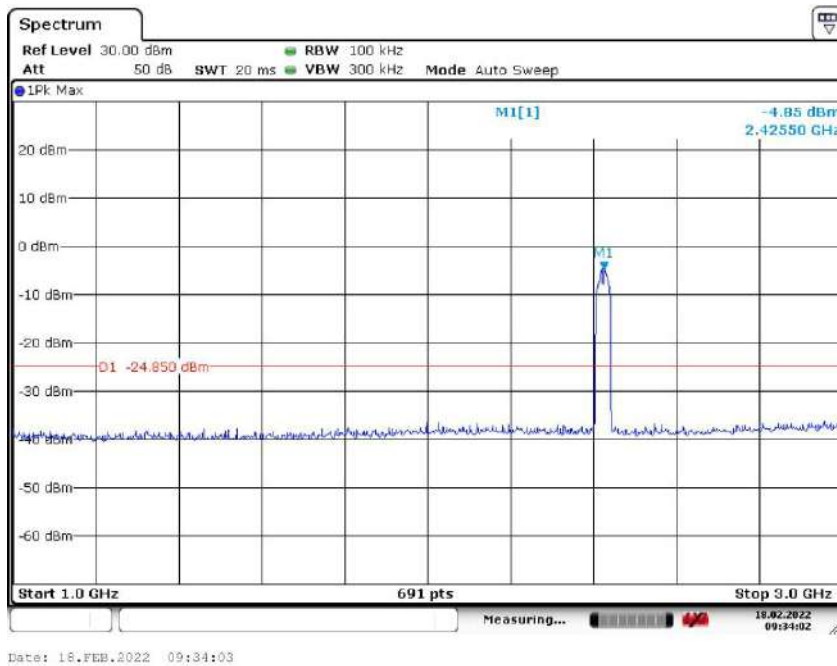

3 G to 13 GHz

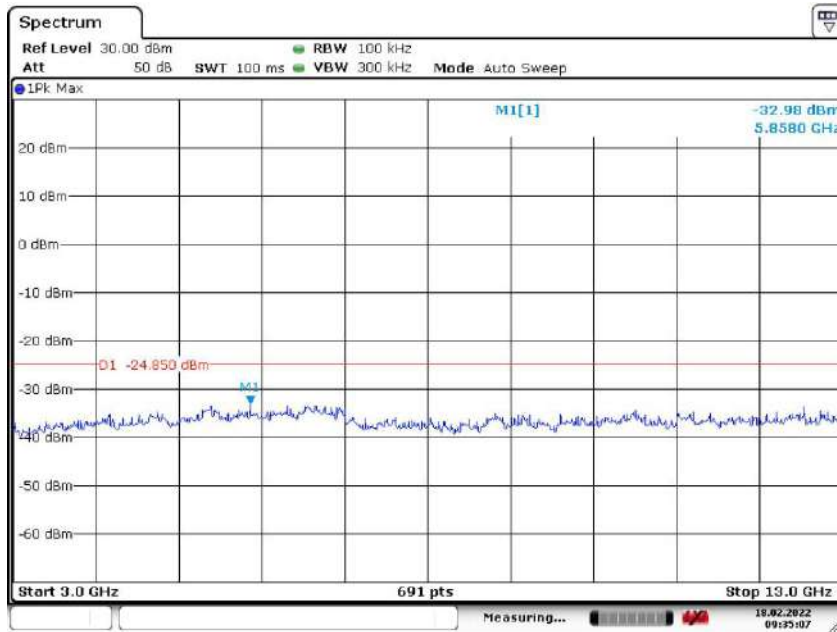

Date: 18.FEB.2022 09:35:07

13 G to 25 GHz

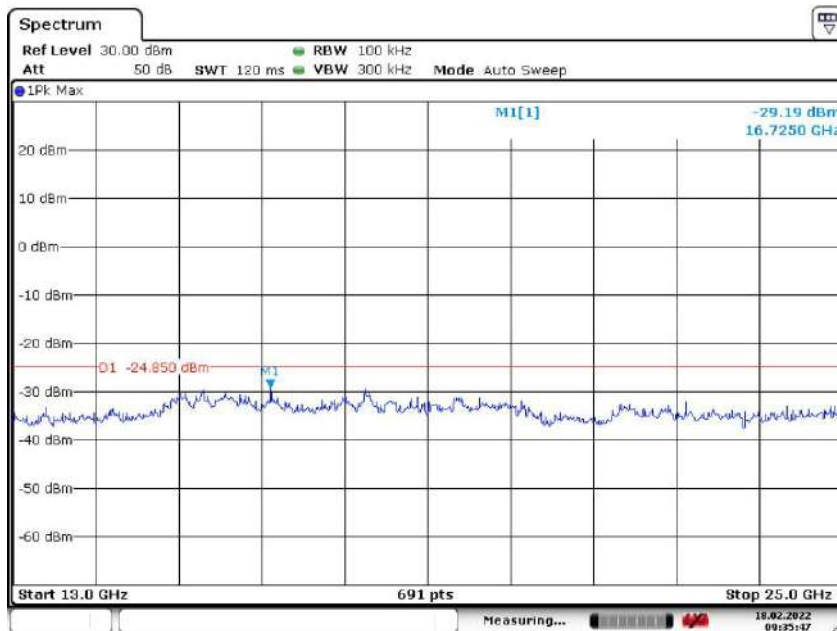

Date: 18.FEB.2022 09:35:48

Channel 6: 2.437GHz:

30 MHz to 1 GHz

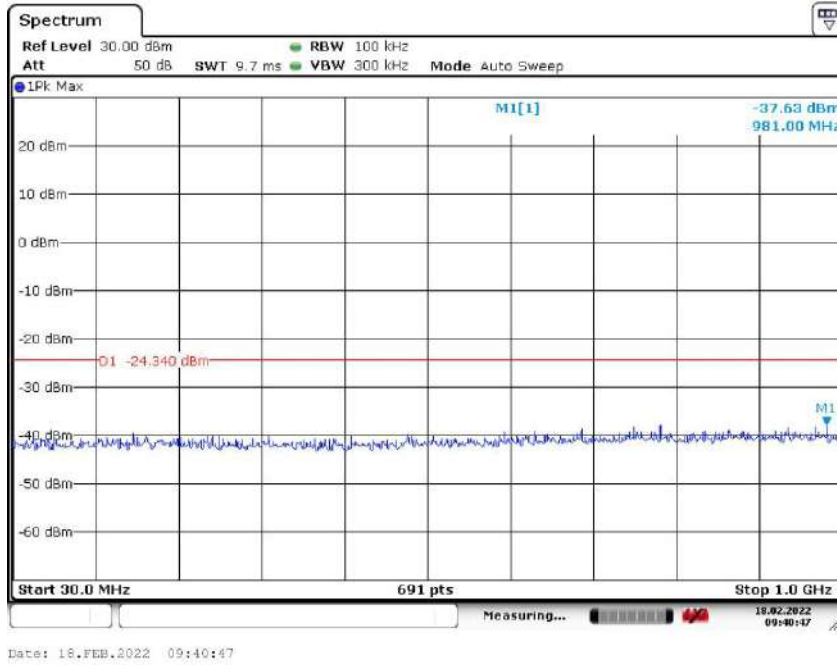

1 G to 3 GHz

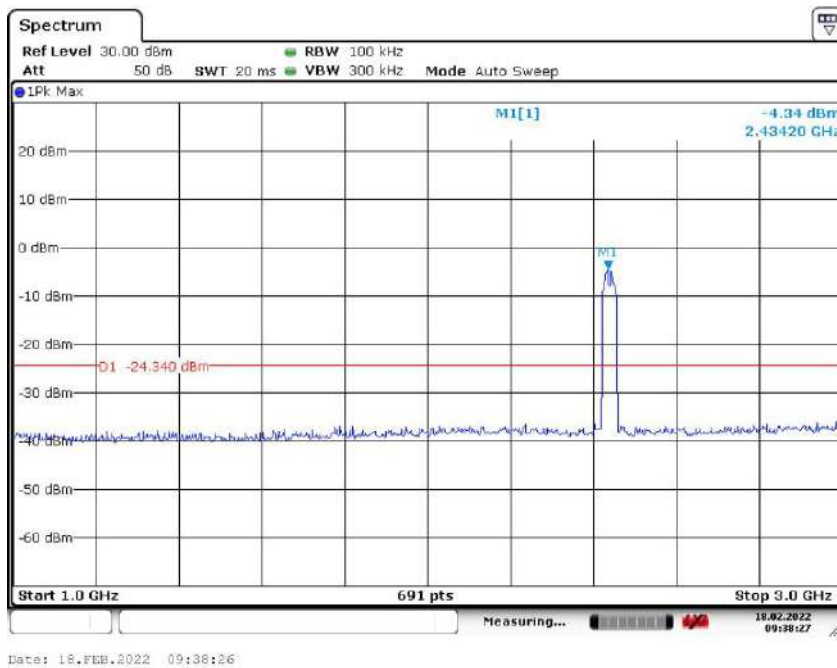

3 G to 13 GHz

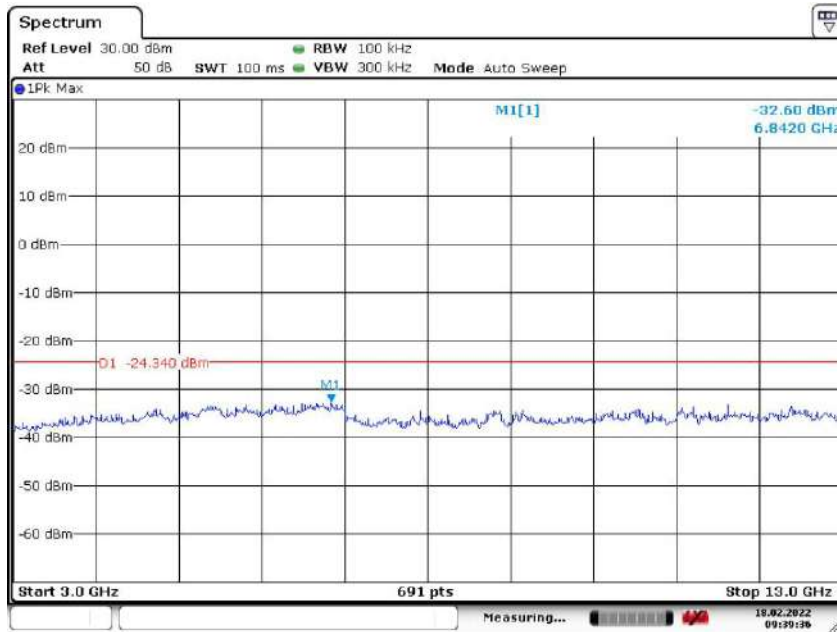

Date: 18.FEB.2022 09:39:36

13 G to 25 GHz

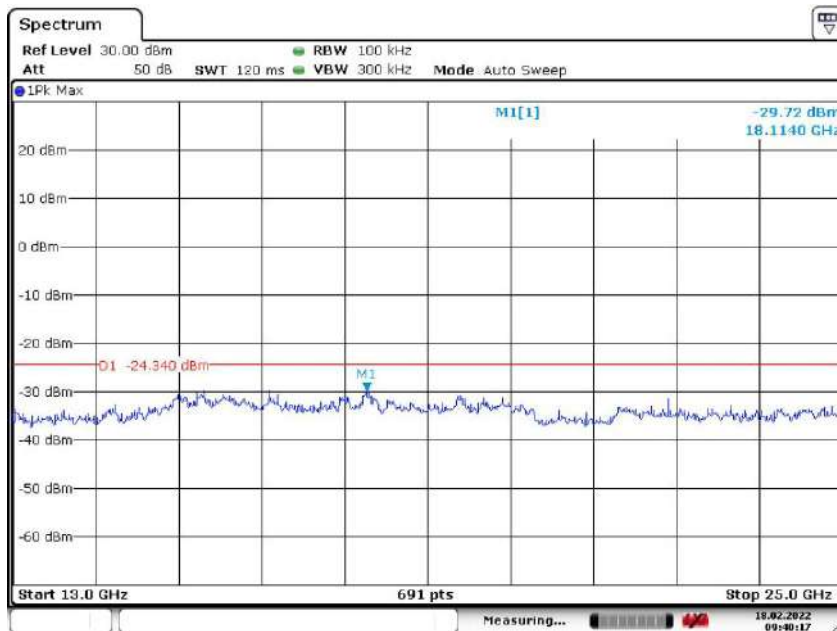

Date: 18.FEB.2022 09:40:17

Channel 9:2.452 GHz

30 MHz to 1 GHz

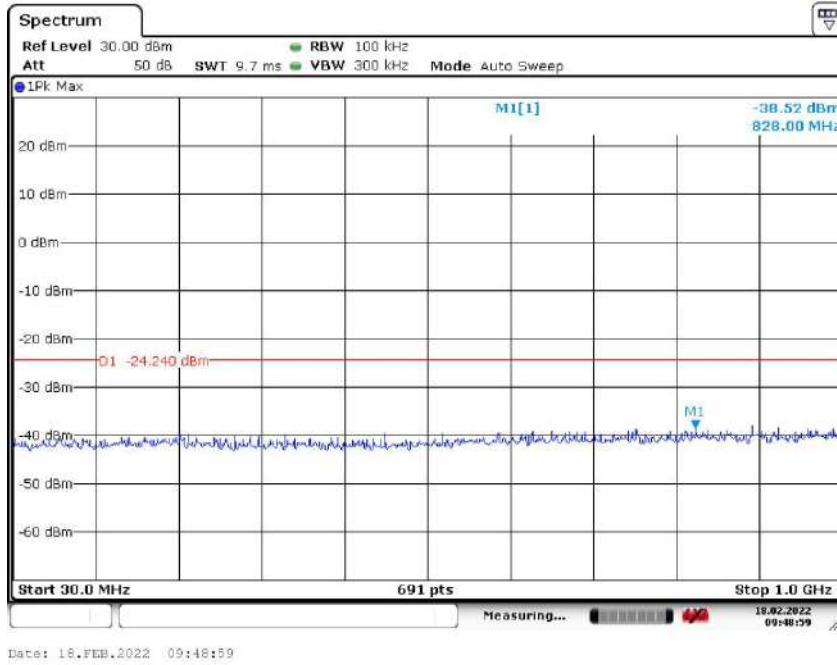

1 G to 3 GHz

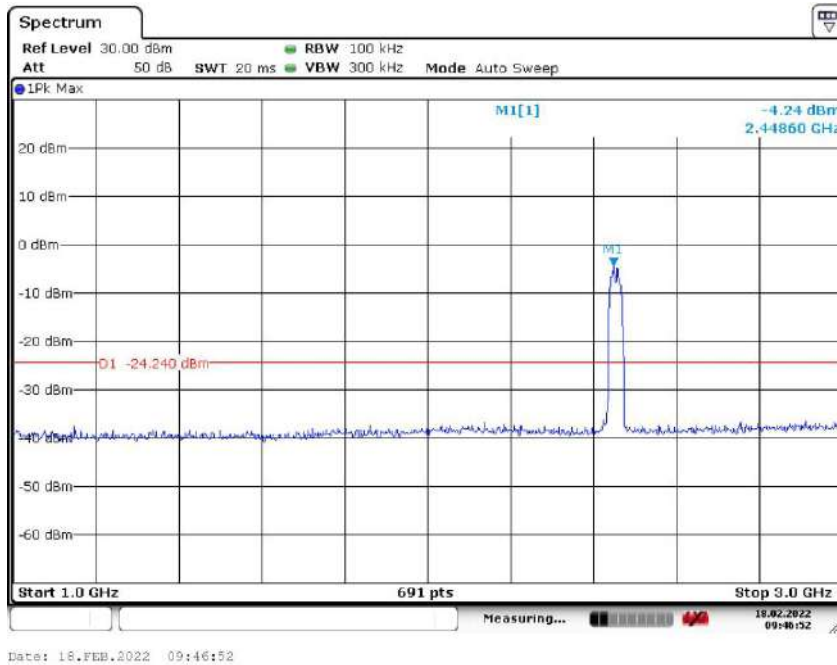

3 G to 13 GHz

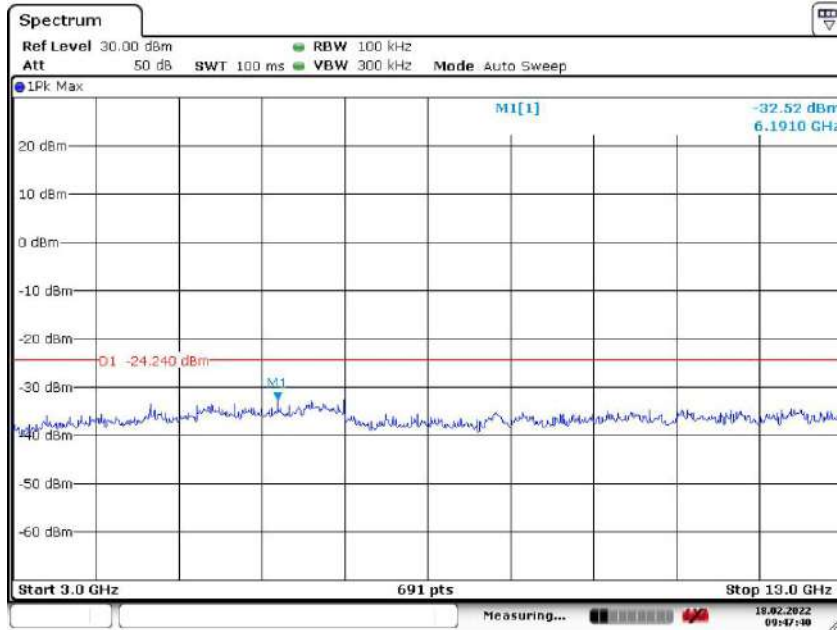

Date: 18.FEB.2022 09:47:39

13 G to 25 GHz

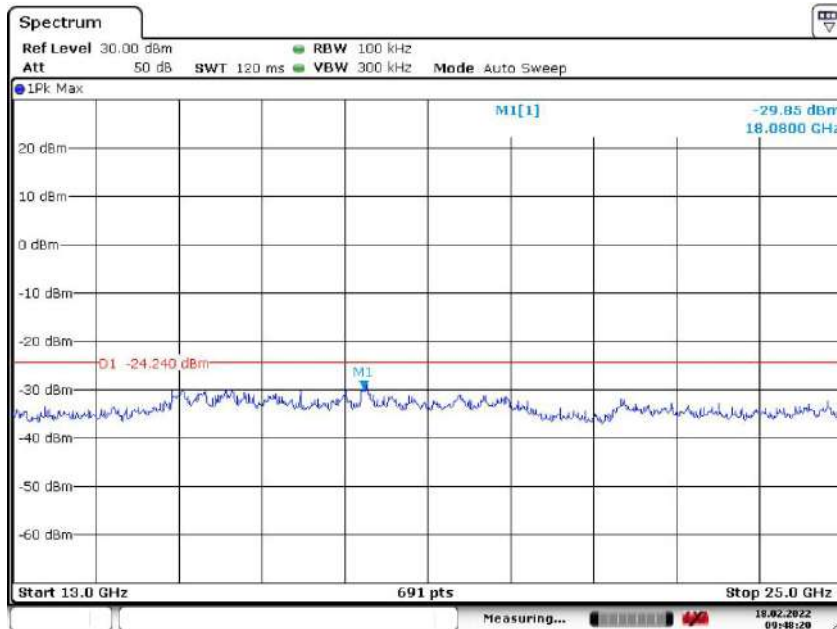

Date: 18.FEB.2022 09:48:21

Result plot as follows: ANT J4
802.11b mode with 11Mbps data rate

Channel 1: 2.412GHz:

30 MHz to 1 GHz

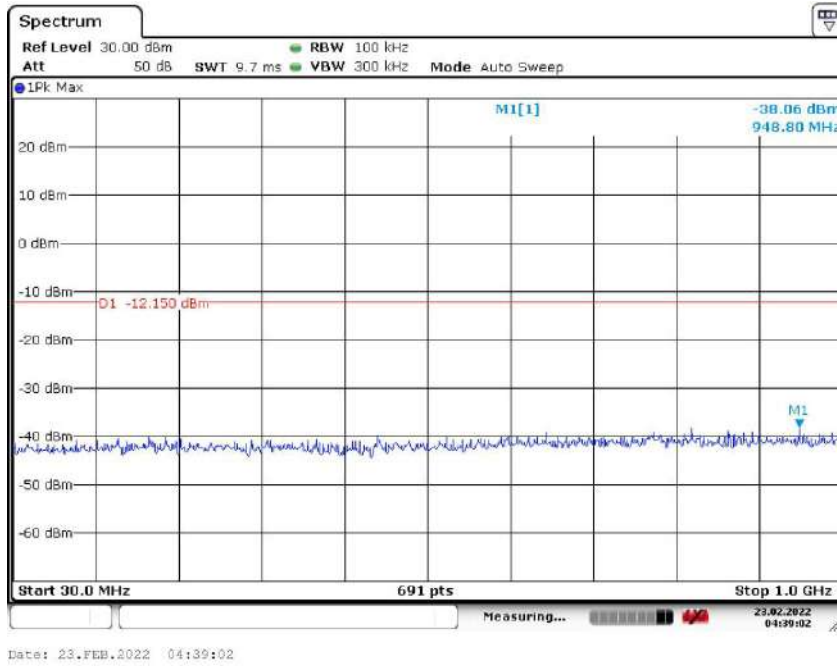

1 G to 3 GHz

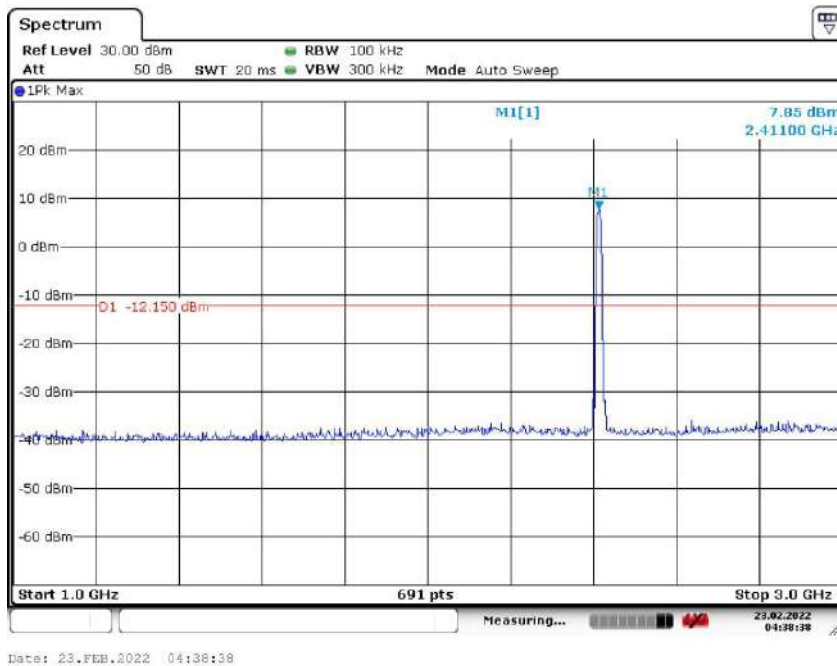

3 G to 13 GHz

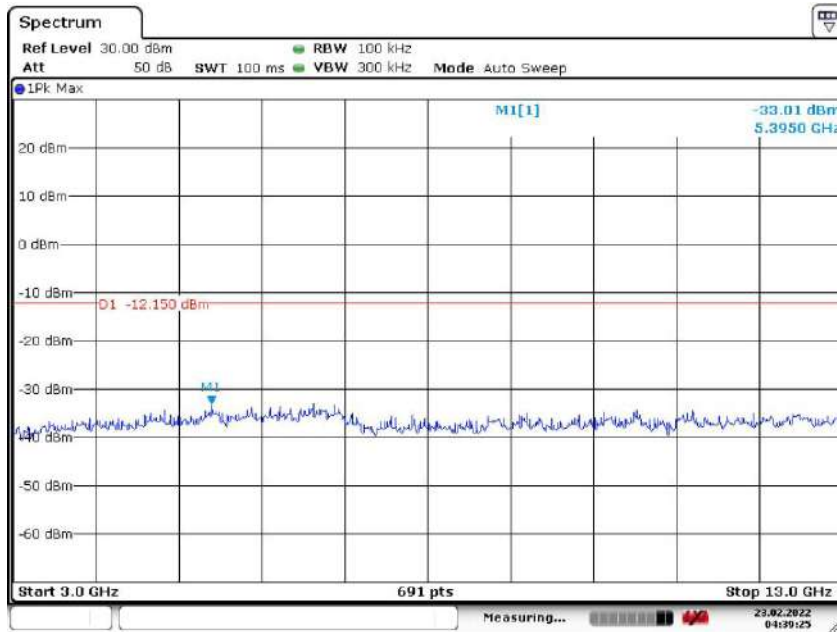

Date: 23.FEB.2022 04:39:25

13 G to 25 GHz

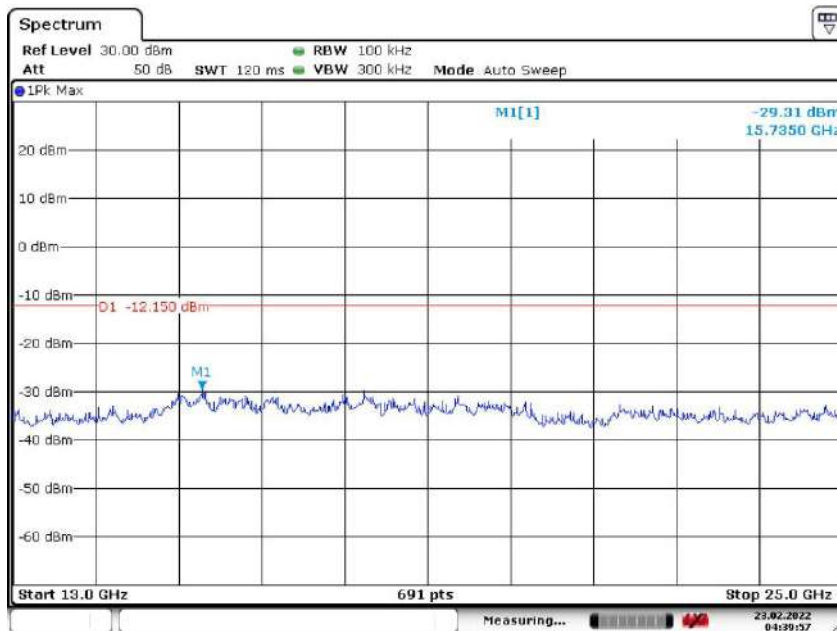

Date: 23.FEB.2022 04:39:57

Channel 6: 2.437GHz:

30 MHz to 1 GHz

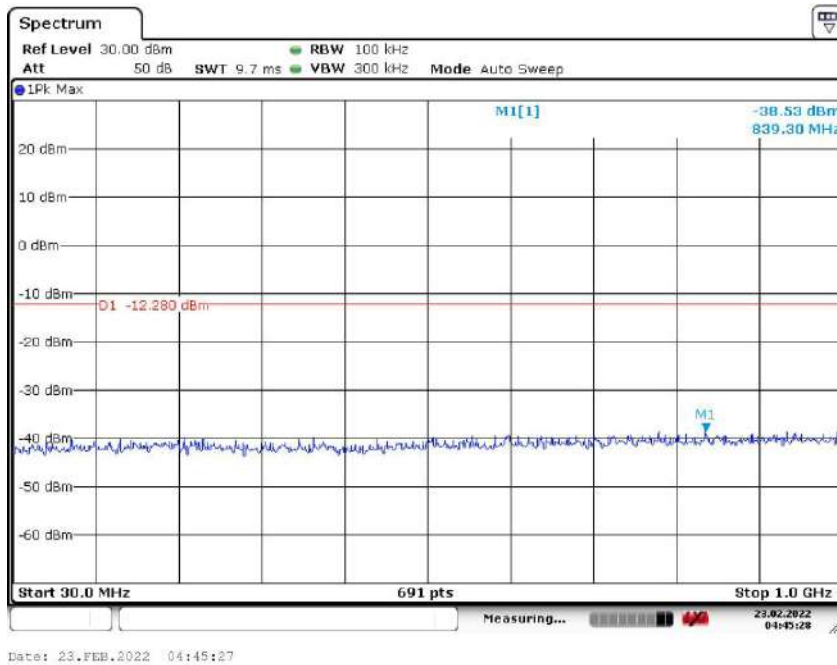

1 G to 3 GHz

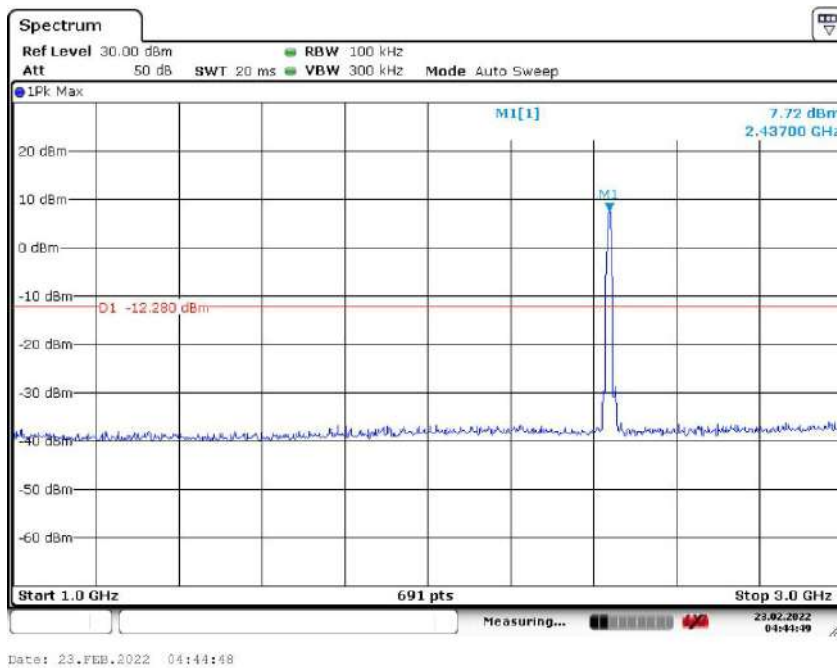

3 G to 13 GHz

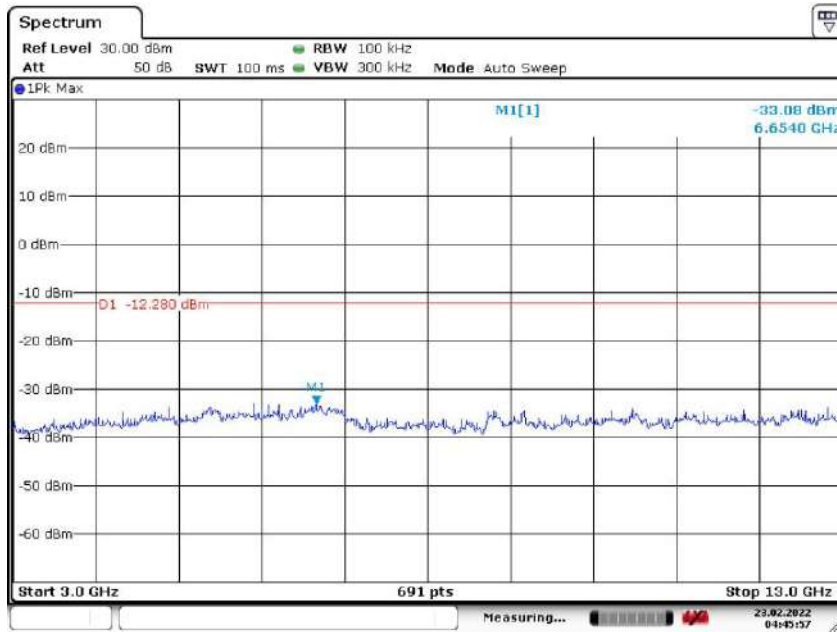

Date: 23.FEB.2022 04:45:56

13 G to 25 GHz

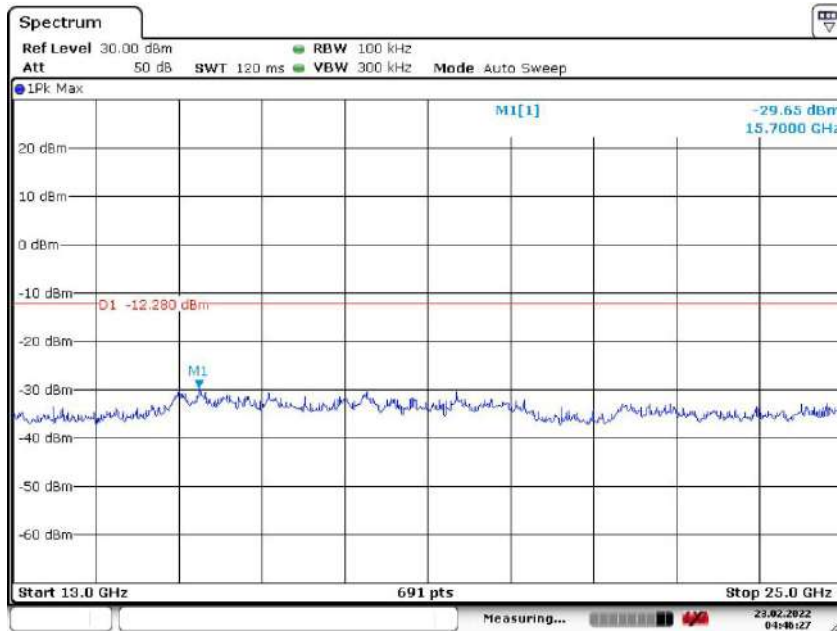

Date: 23.FEB.2022 04:46:27

Channel 11:2.462 GHz

30 MHz to 1 GHz

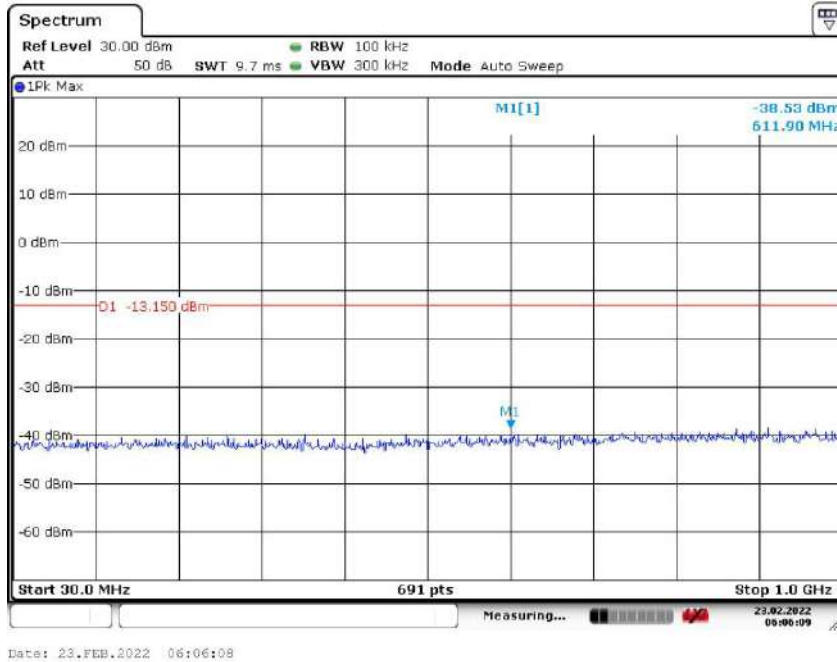

1 G to 3 GHz

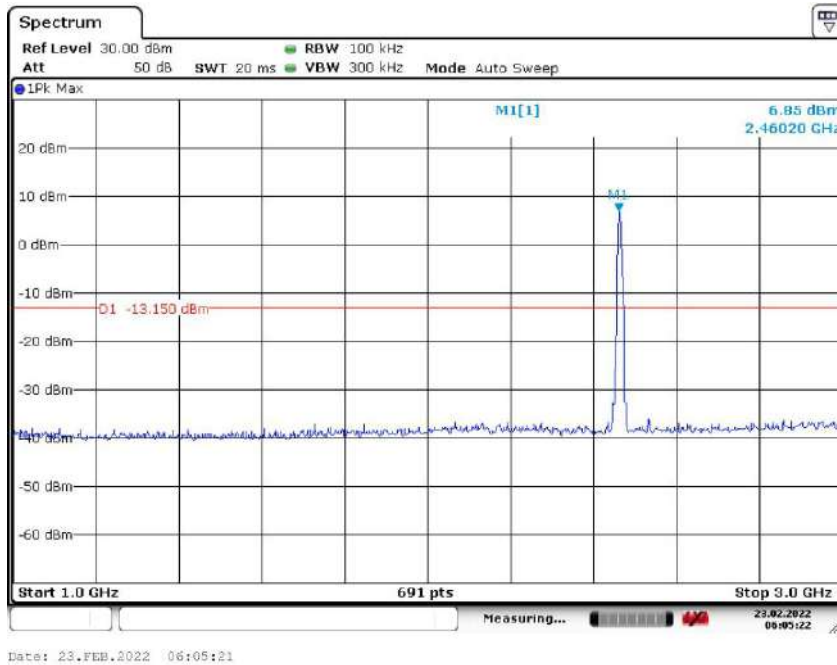

3 G to 13 GHz

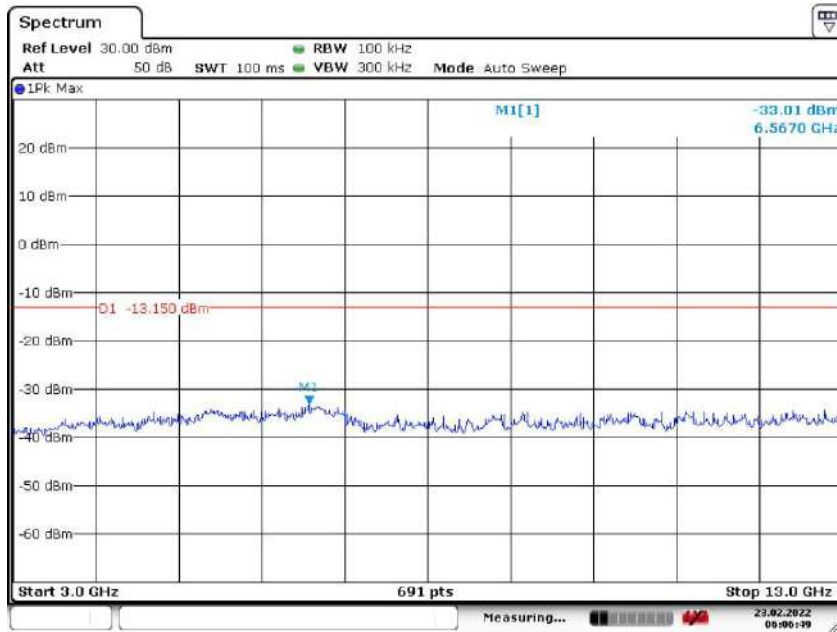

Date: 23.FEB.2022 06:06:49

13 G to 25 GHz

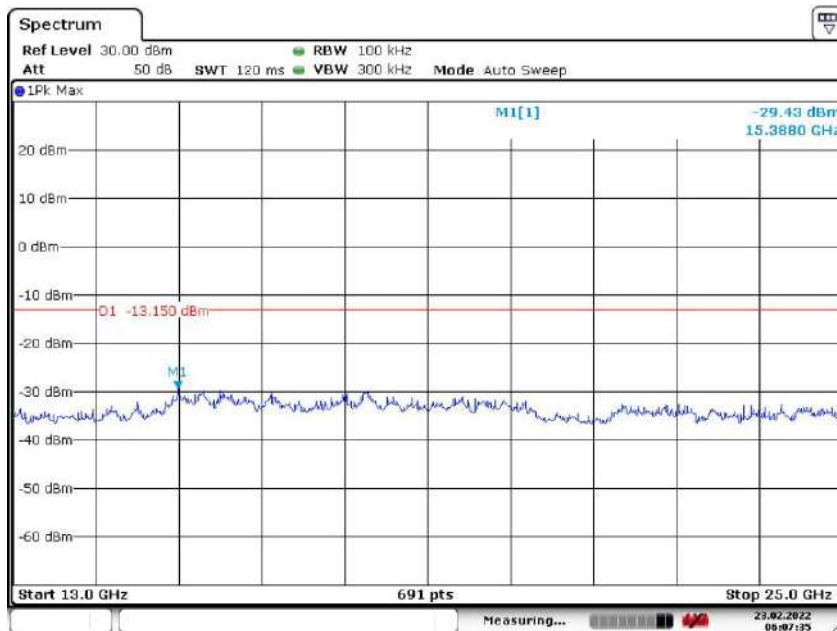

Date: 23.FEB.2022 06:07:34

802.11g mode with 54Mbps data rate

Channel 1: 2.412GHz:

30 MHz to 1 GHz

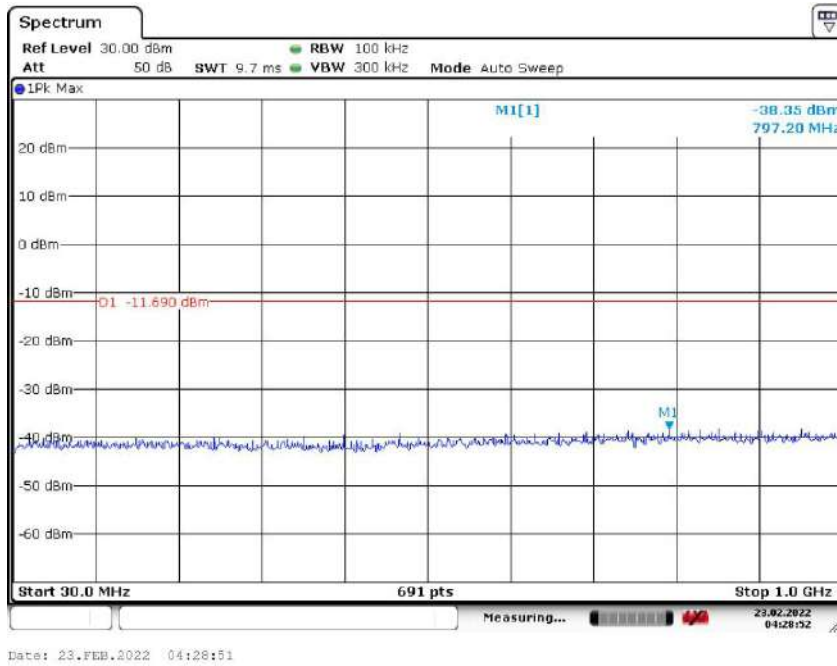

1 G to 3 GHz

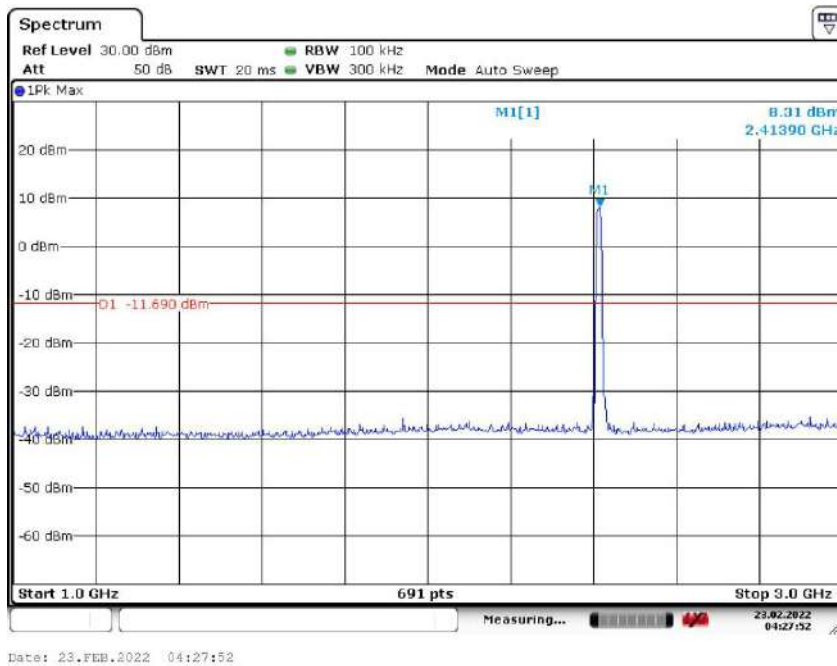

3 G to 13 GHz

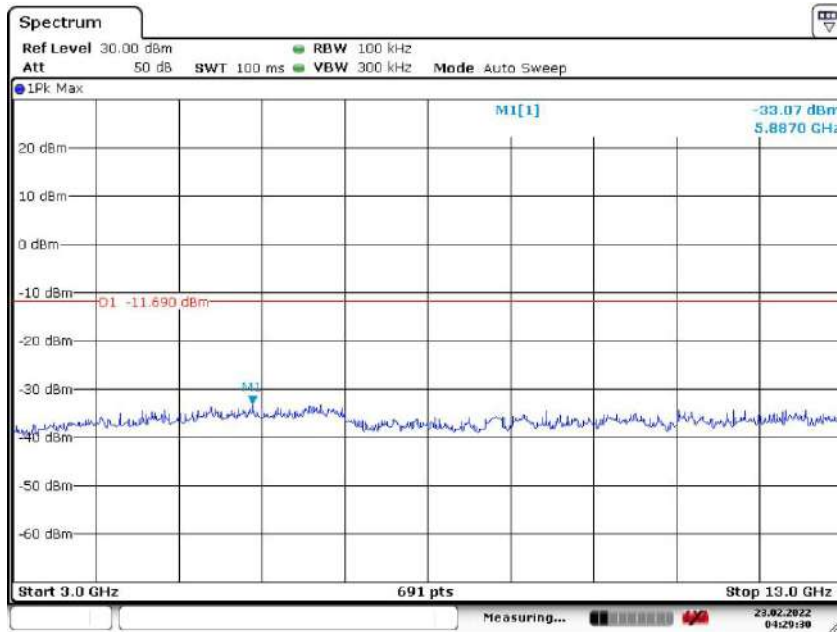

Date: 23.FEB.2022 04:29:29

13 G to 25 GHz

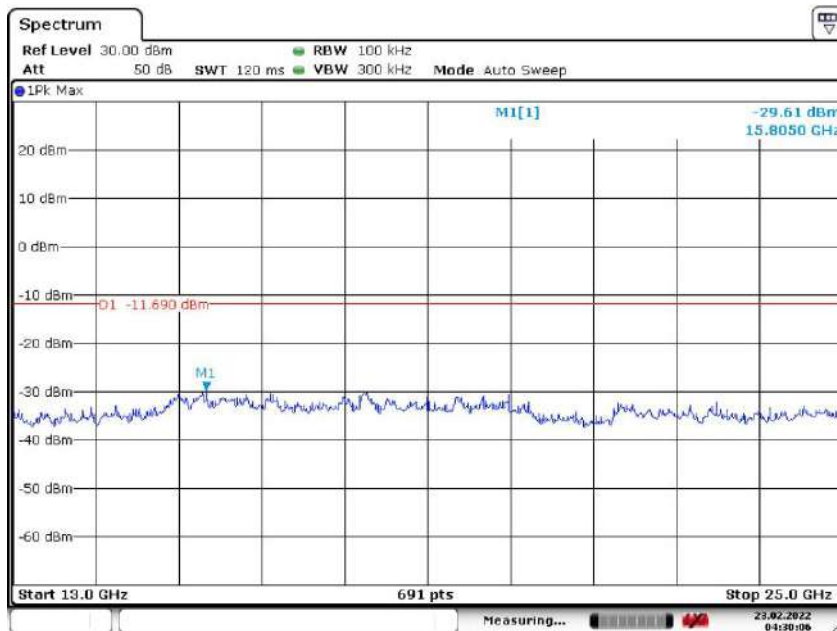

Date: 23.FEB.2022 04:30:05

Channel 6: 2.437GHz:

30 MHz to 1 GHz

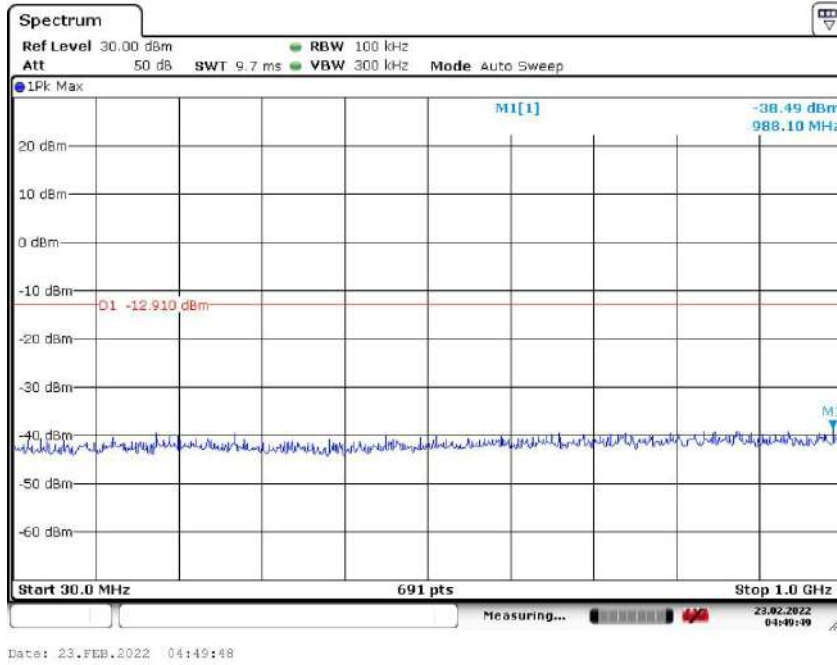

1 G to 3 GHz

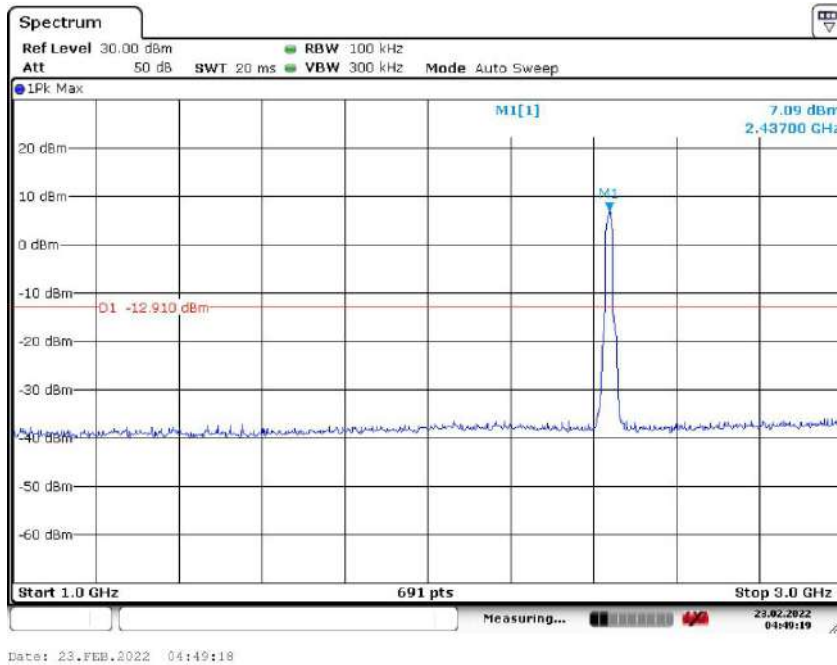

3 G to 13 GHz

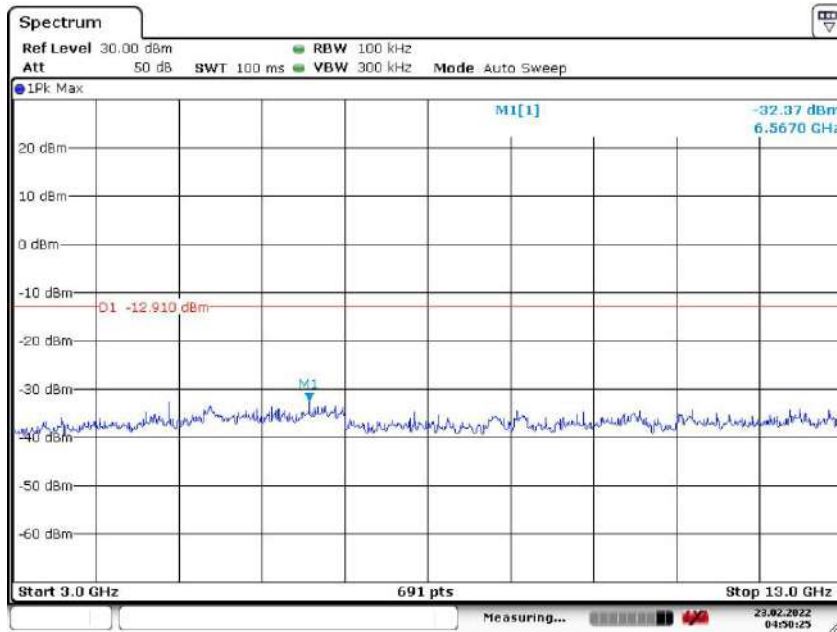

Date: 23.FEB.2022 04:50:24

13 G to 25 GHz

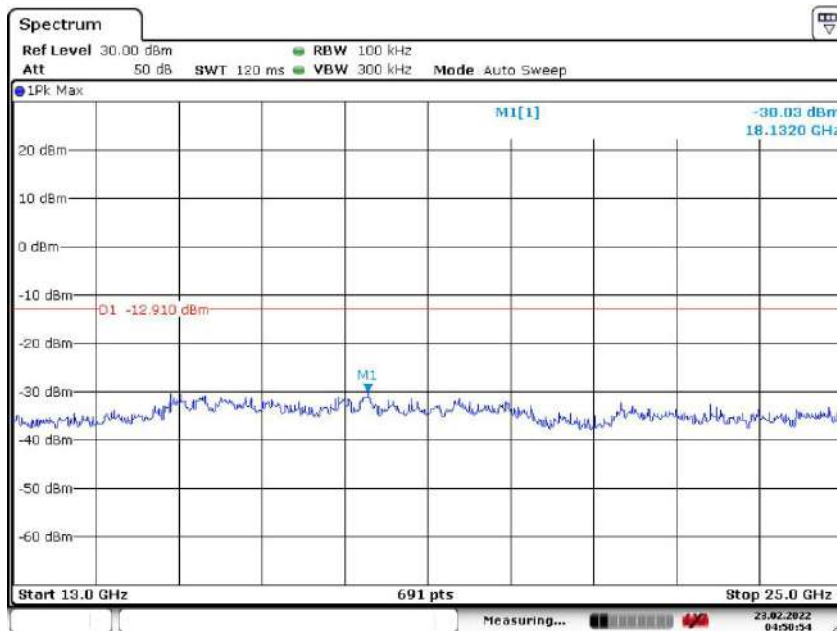

Date: 23.FEB.2022 04:50:54

Channel 11:2.462 GHz

30 MHz to 1 GHz

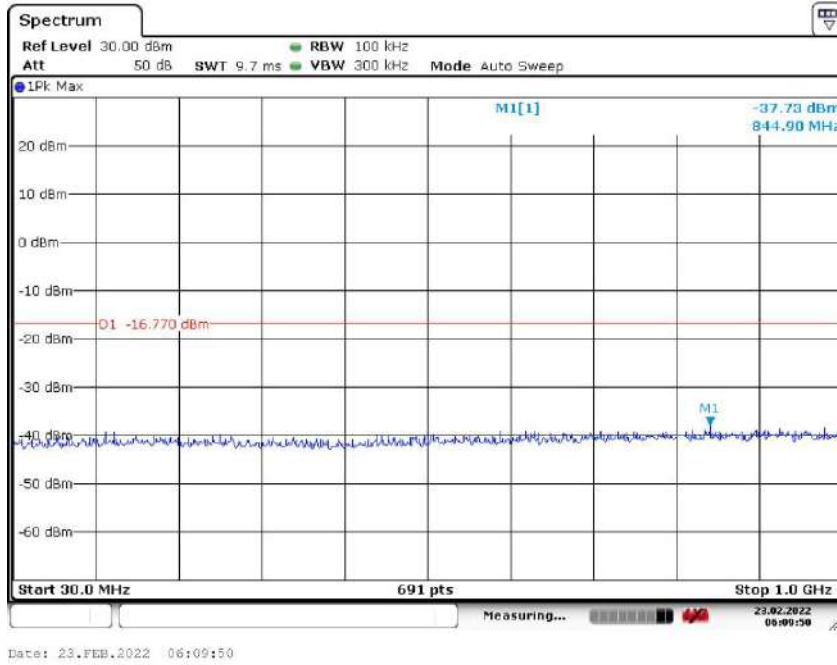

1 G to 3 GHz

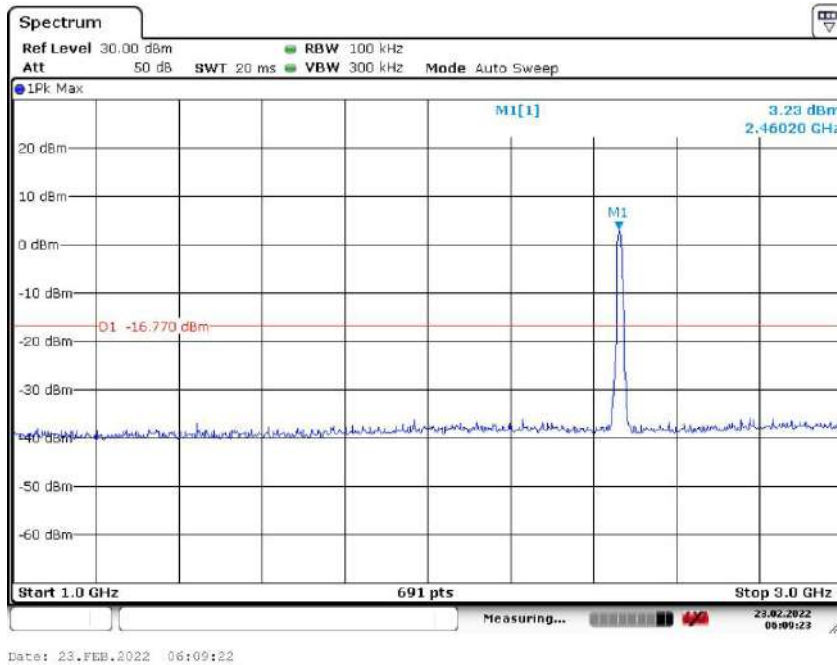

3 G to 13 GHz

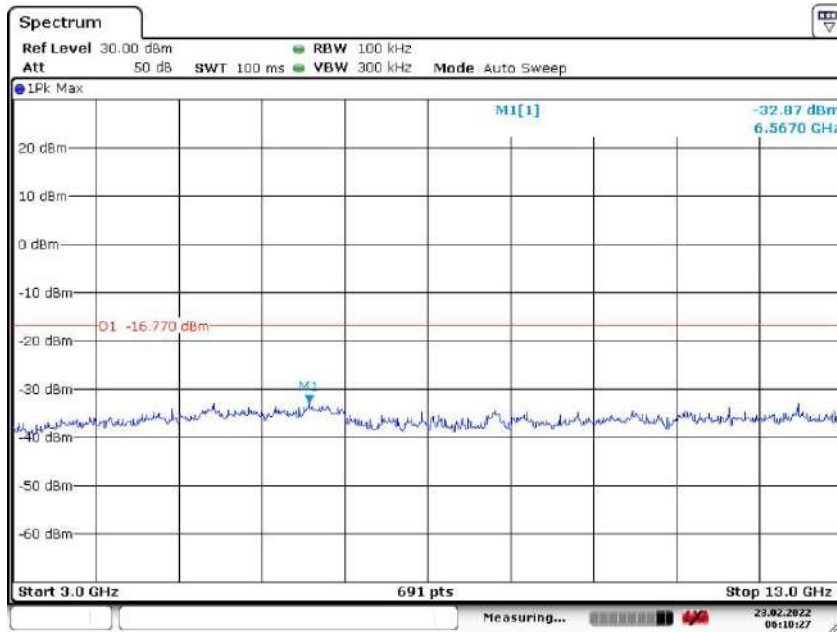

Date: 23.FEB.2022 06:10:27

13 G to 25 GHz

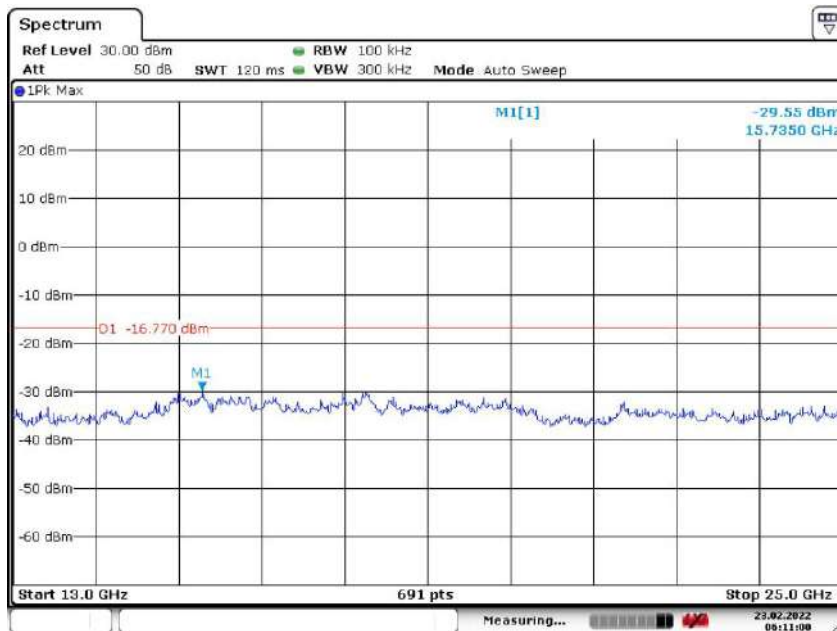

Date: 23.FEB.2022 06:10:59

802.11n(HT20) mode with 72.2Mbps data rate

Channel 1: 2.412GHz:

30 MHz to 1 GHz

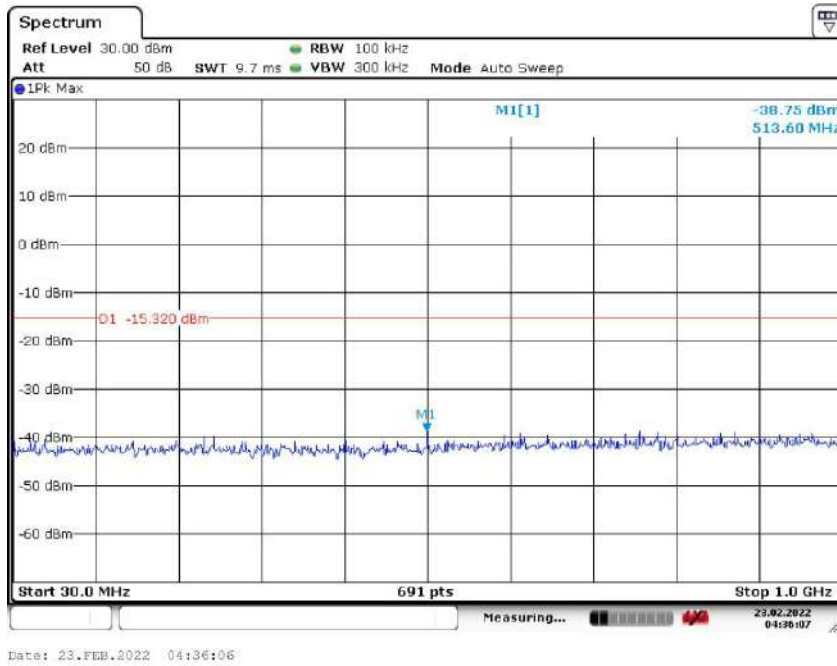

1 G to 3 GHz

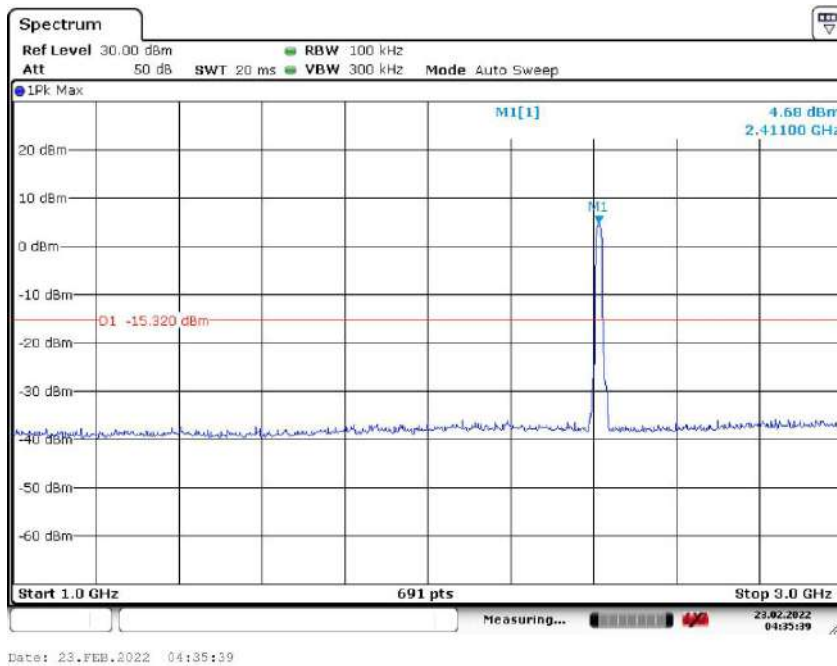

3 G to 13 GHz

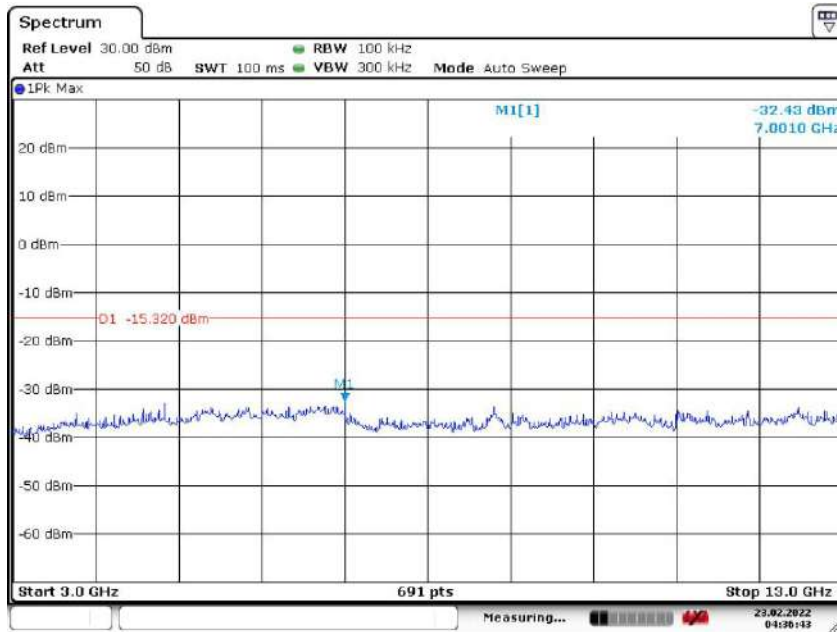

Date: 23.FEB.2022 04:36:43

13 G to 25 GHz

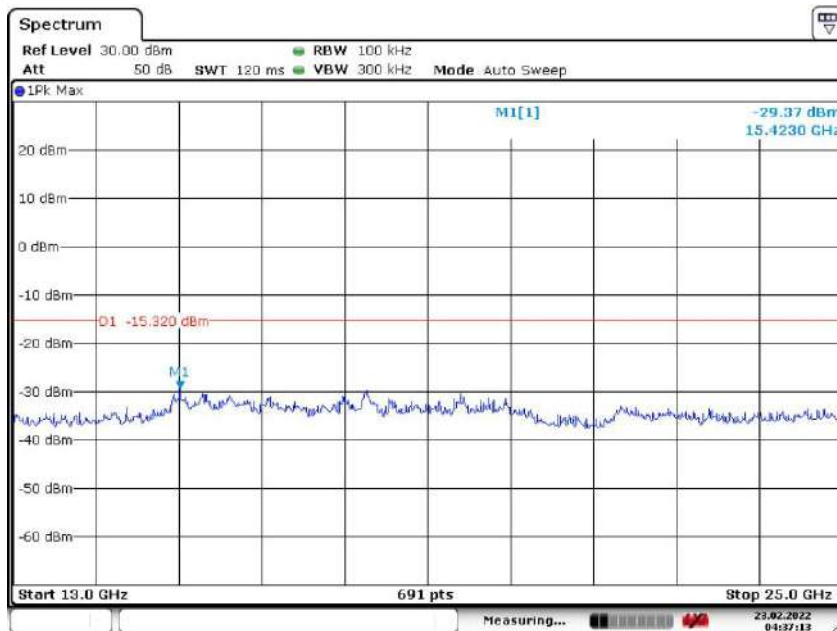

Date: 23.FEB.2022 04:37:13

Channel 6: 2.437GHz:

30 MHz to 1 GHz

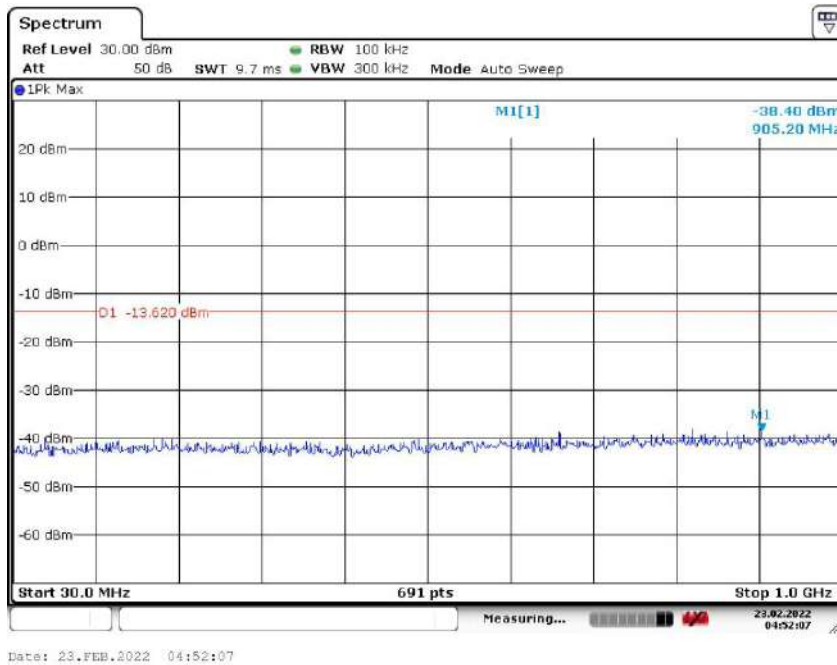

1 G to 3 GHz

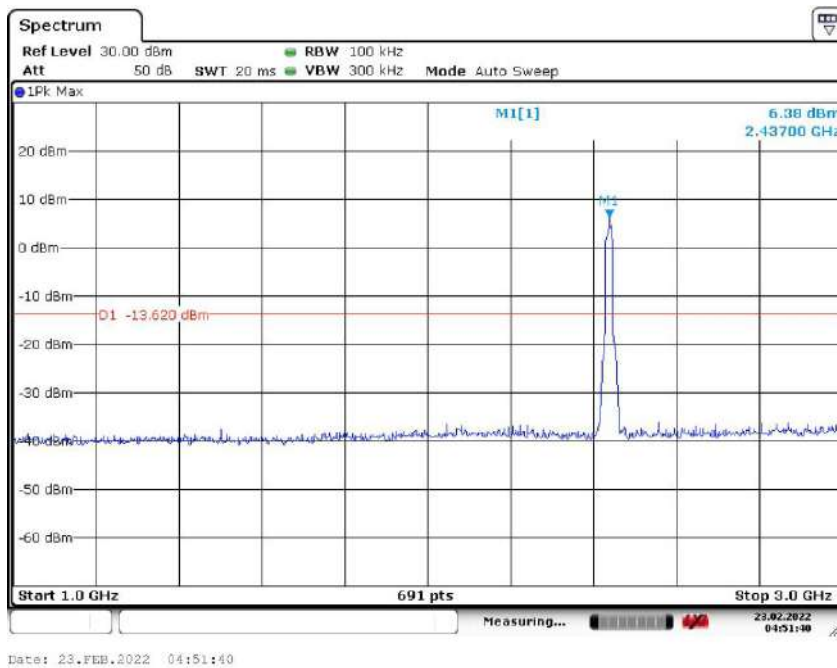

3 G to 13 GHz

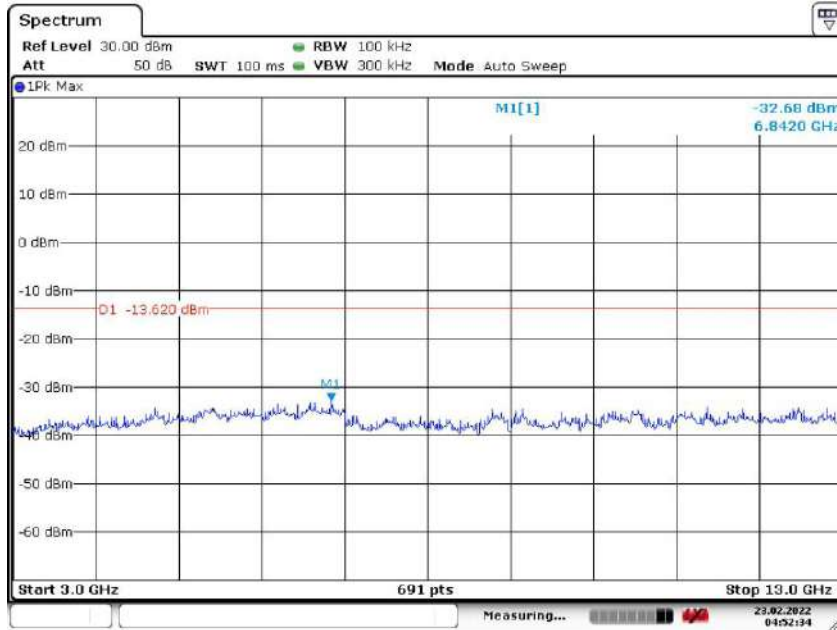

Date: 23.FEB.2022 04:52:34

13 G to 25 GHz

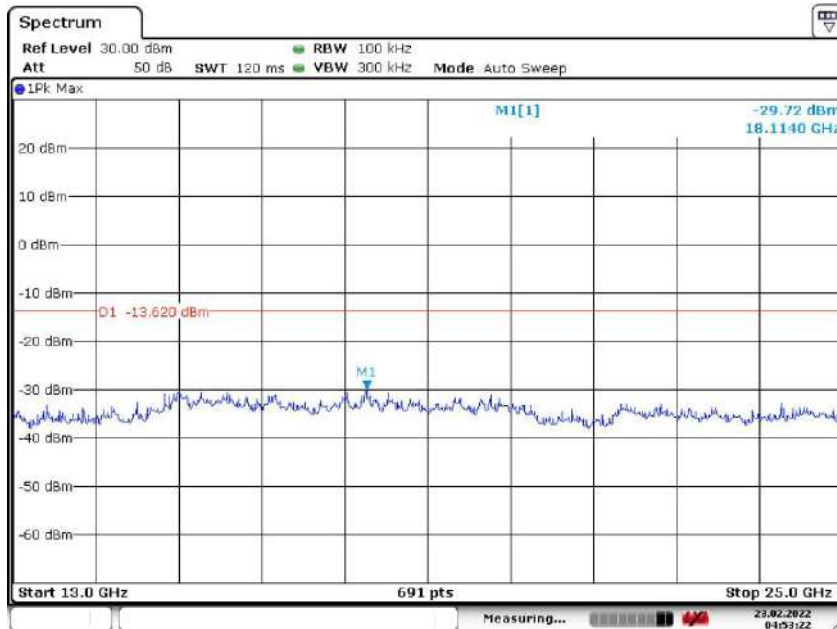

Date: 23.FEB.2022 04:53:22

Channel 11:2.462 GHz

30 MHz to 1 GHz

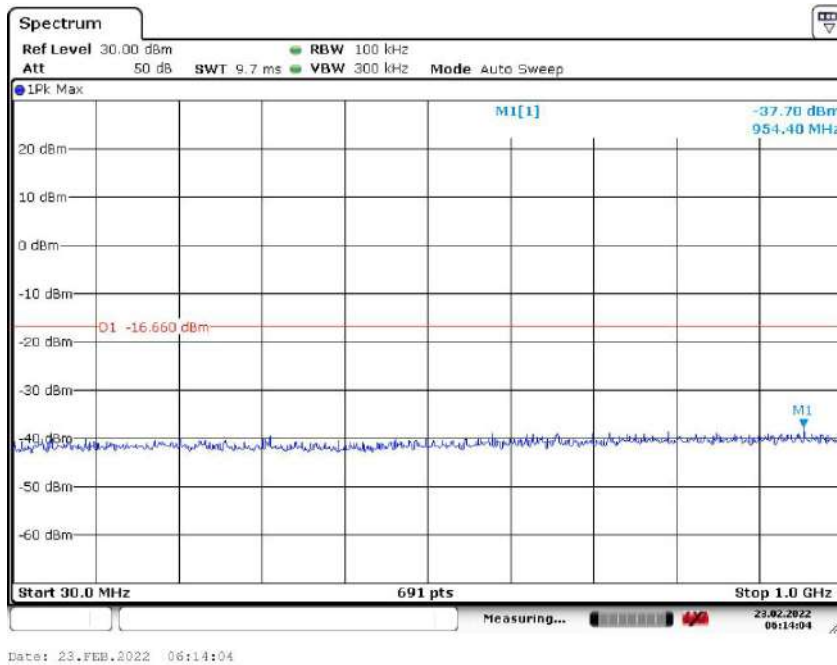

1 G to 3 GHz

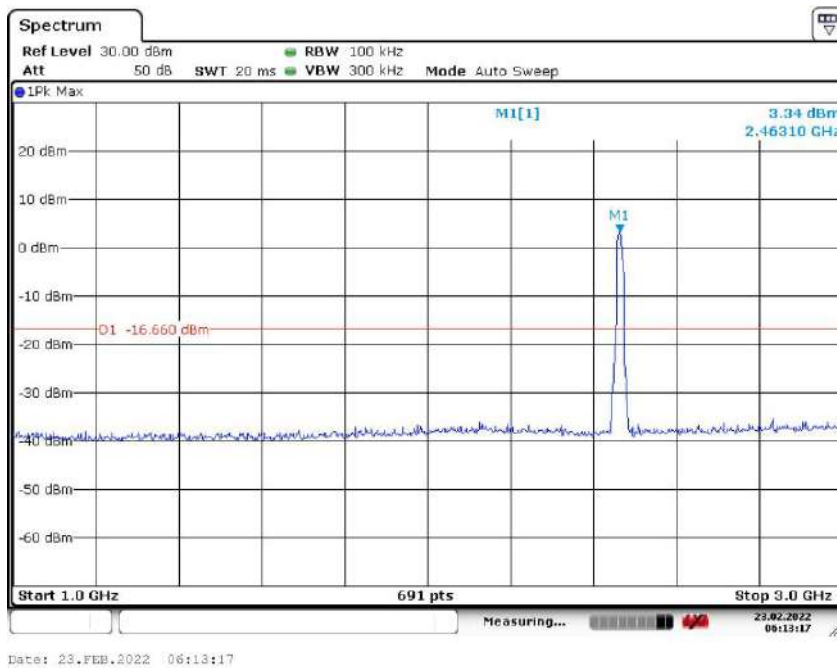

3 G to 13 GHz

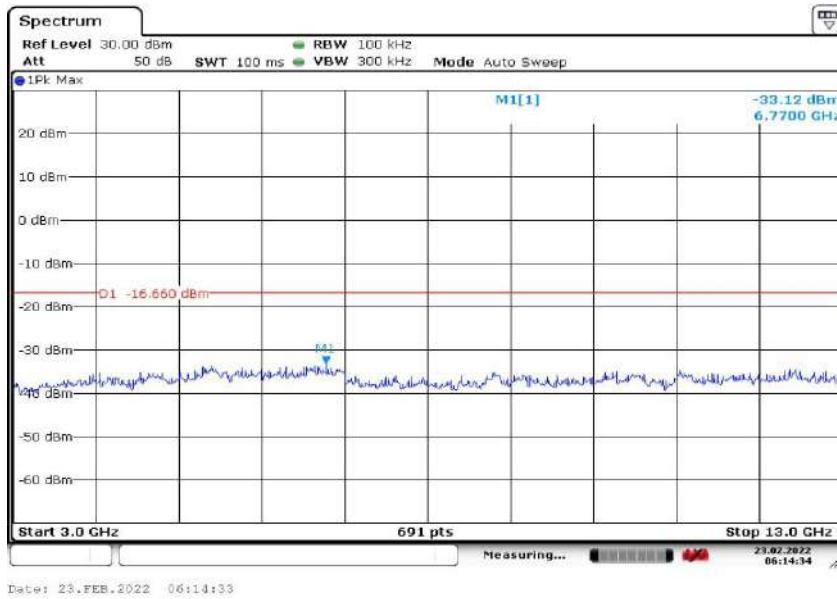

13 G to 25 GHz

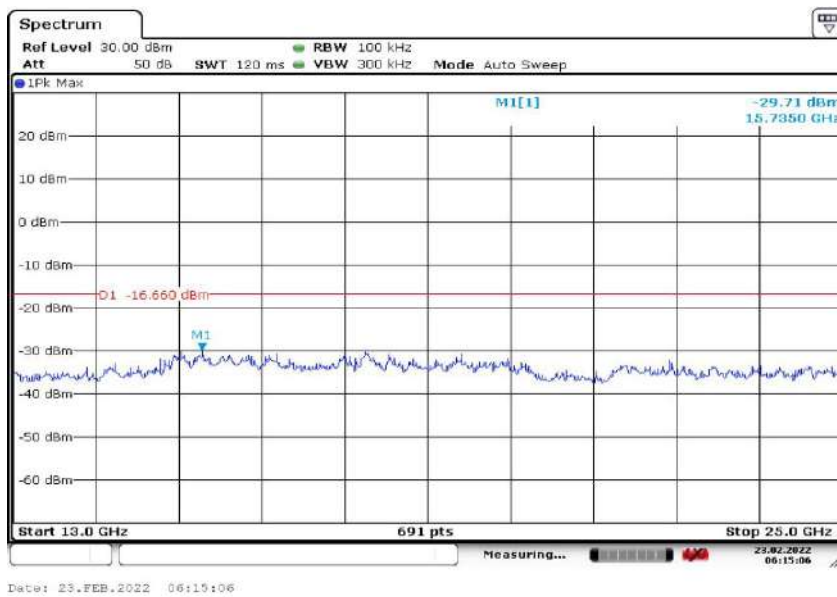

****End of report****