

SKU	
型号+产品名称+文件名称	D30BL & G50BL & D50BL & D100BL 泛光灯 蓝牙款 (带插头不带开关) 说明书 Onforu
尺寸(长x宽x高)mm	展开尺寸: 770 X 130mm 折后尺寸110 X 130mm
材质	105G双铜纸 四色印刷 正反面印刷 风琴折
料号	A33D1017Z02
版本号	Z02 (增加D50BL 型号)

包装	电子	结构	确认人	审核人
林利诚				
日期: 2023.1.31	日期:	日期:	日期:	日期:



LED FLOOD LIGHT
Product Manual

MODEL: D30BL G50BL
 D50BL D100BL

COMPONENTS AND STRUCTURE

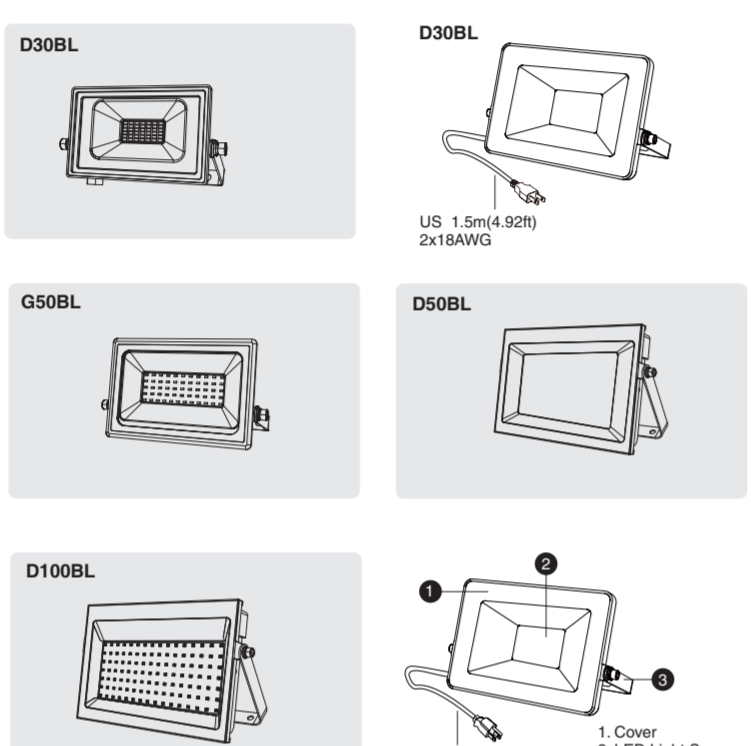

D30BL: US 1.5m(4.92ft) 2x18AWG

D50BL: 1. Cover
2. LED Light Source
3. Lamp Bracket

D100BL: US 1.5m(4.92ft) 3x18AWG

SPECIFICATIONS

LED FLOOD LIGHT				
Model	D30BL	G50BL	D50BL	D100BL
Input Voltage	100-120V ~ 60Hz			
Input Current	0.32A	0.56A	0.56A	1.07A
Rated Power	25W	50W	50W	100W
Luminous Flux	2000lm	4000lm	4000lm	7200lm
CCT	2700K			
CRI	≥90			
Color	RGB			
Power Factor	≥0.5			
Beam Angle	120°			
ta	-20~40°C/-4°F~104°F			
Luminaire Location	SUITABLE FOR WET LOCATIONS			
DIMENSIONS				
Model	D30BL	G50BL		
Dimensions (LxHxW)	205x30x125 mm / 8.07x1.18x4.92 in	230x35x139 mm / 9.06x1.36x5.47 in		
Weight	0.49 kg / 1.08 lb	0.95KG / 2.09lb		
Model	D50BL	D100BL		
Dimensions (LxHxW)	208x127x37 mm / 8.19x5x1.46in	289x39x177 mm / 11.38x1.54x6.97in		
Weight	0.58 kg / 1.28 lb	1.2 kg / 2.65 lb		

APP INSTALLATIONS

STEP 1

- Please scan the QR code.
- Search for "Happy Lighting" in the Apple Store or Google Play.
- Download and install the App, as shown in the picture.



STEP 2

Note:

- Before using the app, please make sure that the Bluetooth of your mobile phone is enabled.
- Unable to connect to Bluetooth: After you open the app and select the color, the color doesn't change on the flood light, it means that the Bluetooth fails to connect. The light might have been connected to the other phone.

- You need to disconnect the Bluetooth of the other phone, and then your phone will be automatically connected to the light. At this time, when you turn on the Bluetooth, it will show that the device Trick-XXXX is come led, which means that the Bluetooth is connected now.
- Open the APP and place the phone near the light, it will be connected to the nearest Bluetooth without blocking, after the light is turned off and turned on again.

APP OPERATING INSTRUCTIONS

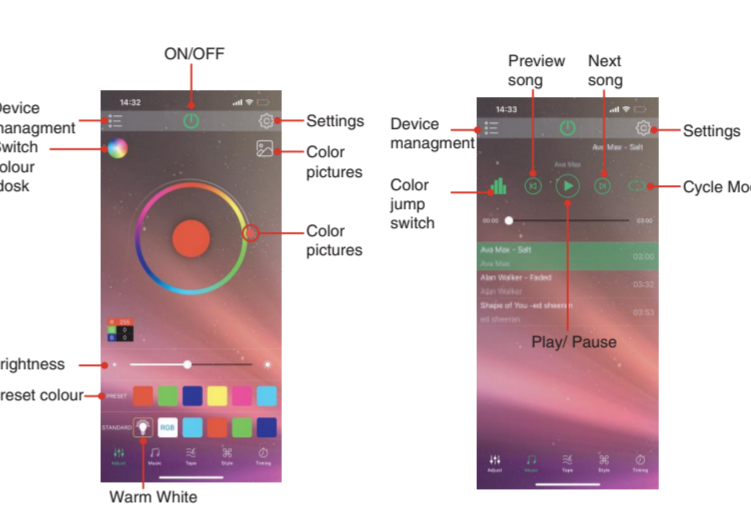

Brightness Selection Interface: You could adjust the brightness.

Music Mode Interface: You could control the brightness and dynamic changes of the light by playing local music in the phone.

APP OPERATING INSTRUCTIONS

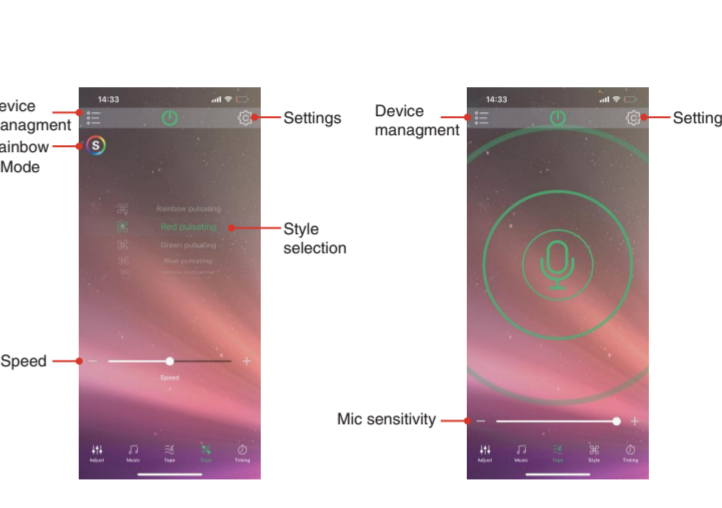

Dynamic Mode Interface: The light has 5 dynamic modes (Gradient, Breathing, Strobe, Jump, Auto), and speed can be adjusted.

Mobile Speaker: The dynamic modes can change with the sound inside the phone or other external sounds.

APP OPERATING INSTRUCTIONS

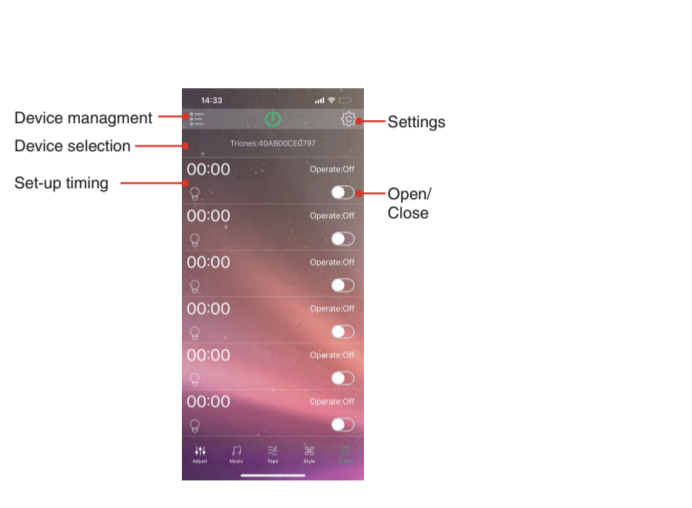

Timing Interface: You can turn on or turn off the light regularly.

HOW TO CONTROL LIGHTS IN GROUPS

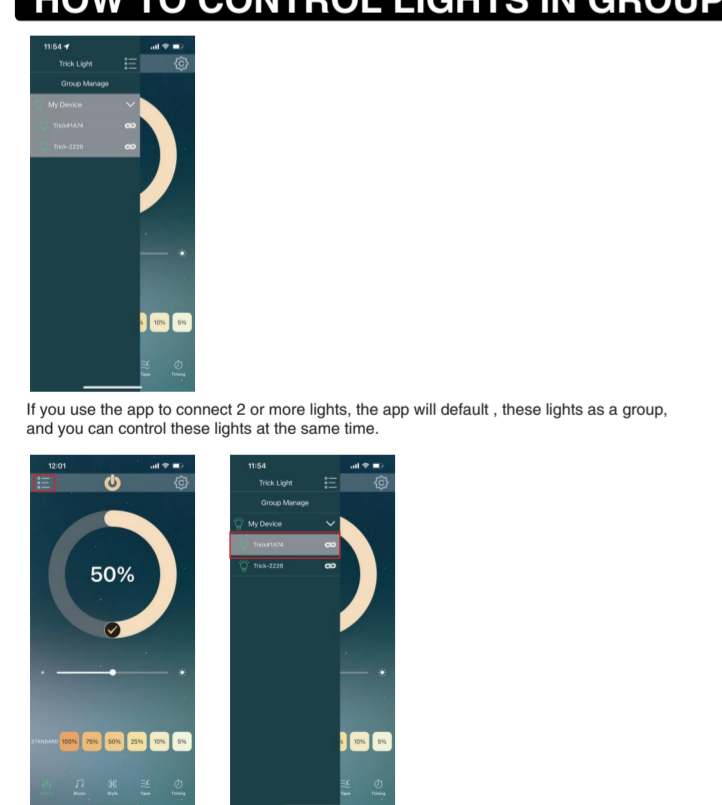

If you use the app to connect 2 or more lights, the app will default , these lights as a group, and you can control these lights at the same time.

If you want to control one of the lights separately, select the light first and then control it.

PREPARATION

Check all components for damage, do not use the product if it is damaged.
Estimated Assembly Time:10-30 minutes

TOOLS REQUIRED (not included)

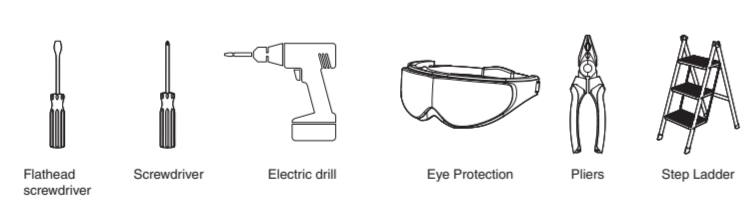

PREPARATION

CAUTION: PLEASE MAKE SURE YOUR WALL SWITCH AND POWER AT MAIN CIRCUIT BREAKER BOTH ARE OFF. IF IN DOUBT ABOUT ELECTRICAL INSTALLATION, CONSULT A LICENSED ELECTRICIAN.

WARNING: INSTALLING THIS LIGHT IN AN UNGROUNDED ELECTRICAL SYSTEM MAY CAUSE THE METAL PARTS OF THE LIGHT TO CARRY CURRENT IF ANY WIRES OR WIRE CONNECTIONS ARE DAMAGED OR LOOSE. IN THIS CASE, ANYONE WHO TOUCHES THE LIGHT WILL RECEIVE AN ELECTRIC SHOCK, RESULTING IN INJURY OR DEATH.

BE CAREFUL NOT TO DAMAGE OR CUT THE WIRE INSULATION (COVERING) DURING INSTALLATION. DO NOT LET THE WIRES TOUCH ANY SHARP EDGES.

WARNING: THIS PRODUCT MUST BE INSTALLED IN ACCORDANCE WITH THE APPLICABLE INSTALLATION CODE BY A PERSON FAMILIAR WITH THE CONSTRUCTION AND OPERATION OF THE PRODUCT AND THE HAZARDS INVOLVED. RISK OF SHOCK- BEFORE BEGINNING INSTALLATION,TURN OFF ELECTRICITY AT THE CIRCUIT BREAKER BOX OR THE MAIN FUSE BOX.

INSTALLATION STEPS

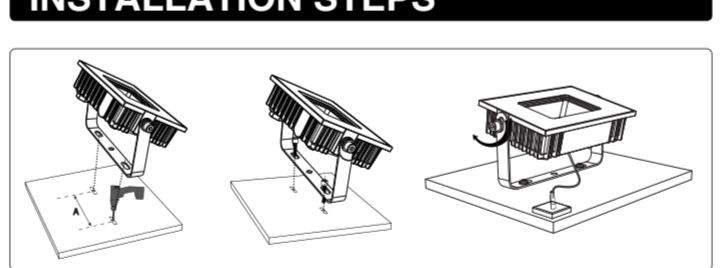

- Step 1: According to the spacing (see the "A" part of the picture) of two screw bits on the LED Light bracket, drill two mounting holes.
- Step 2: Put the bracket onto the prepared mounting holes and then screw it on.
- Step 3: Adjust the beam direction as you like, Wiring.
- Step 4: Adjust the beam direction as you like, and then plug into the main socket.

FCC ID: 2A3W8D100BLM

FCC Warning:

Any Changes or modifications not expressly approved by the party responsible for compliance could void the user's authority to operate the equipment.

This device complies with part 15 of the FCC Rules. Operation is subject to the following two conditions:

- (1) This device may not cause harmful interference, and
- (2) this device must accept any interference received, including interference that may cause undesired operation.

Note: This equipment has been tested and found to comply with the limits for a Class B digital device, pursuant to part 15 of the FCC Rules. These limits are designed to provide reasonable protection against harmful interference in a residential installation. This equipment generates uses and can radiate radio frequency energy and, if not installed and used in accordance with the instructions, may cause harmful interference to radio communications. However, there is no guarantee that interference will not occur in a particular installation. If this equipment does cause harmful interference to radio or television reception, which can be determined by turning the equipment off and on, the user is encouraged to try to correct the interference by one or more of the following measures:

- Reorient or relocate the receiving antenna.
- Increase the separation between the equipment and receiver.
- Connect the equipment into an outlet on a circuit different from that to which the receiver is connected.
- Consult the dealer or an experienced radio/TV technician for help.

This equipment complies with FCC radiation exposure limits set forth for an uncontrolled environment. This equipment should be installed and operated with minimum distance 20cm between the radiator & your body.

HK Bright International Lighting Co., Limited
Unit 616, 6/F., Kam Teem Industrial Building, 135
Connaught Road West, Sai Wan Hong Kong
Manufacturer/Hersteller: MDH LIGHTING LTD
Suite 302, 292 Strovolos Avenue, 2048 Strovolos Nicosia,
Cyprus
UK Importer: MDH LIGHTING LTD
69 Abensden Avenue, Cambridge CB2 8DL,
United Kingdom
Made in China

support@onforuled.com www.onforuleds.com

