

SPECIFICATION

SHEET FOR APPROVAL

(Revision: R: A0)

CUSTOMER	Hesung Innovation Limited
CS P/N	DR-HTF010S
PART NAME	WIFI Antenna
FREQUENCY	2400~2500MHz
ZTX NO.	2.00006417
DATE	2023-11-09

CUSTOMER			
QA CHECKED	ME CHECKED	RF CHECKED	MANAGER CHECKED

Remark:

Sign:

Shenzhen ZTX Communication Technology Co., Ltd				
MANAGER CHECKED	MANAGER CHECKED	ME CHECKED	RF CHECKED	LISTER
		Qin Le	Feng Jianeng	

 **中天迅**

Shenzhen ZTX Communication Technology Co., Ltd

Address: No.34, Shilong Avenue, Shiyao Town, Baoan District, Shenzhen, (Tengda Industrial Park) 518000

Tel.: 0755-27588320 Fax: 0755-27588045 <http://www.chinaztx.com>

ANTENNA SPECIFICATION

CUS P/N :DR-HTF010S WIFI Antenna

Application Date:Nov,09,2023

Rev: R:A0

ZTX P/N :DR-HTF010S WIFI Antenna

Editor:

Page 1 of 9

Revision history

Edition	Date	state
A0	2023-11-09	First edition

ANTENNA SPECIFICATION

CUS P/N :DR-HTF010S WIFI Antenna

Application Date:Nov,09,2023

Rev: R:A0

ZTX P/N :DR-HTF010S WIFI Antenna

Editor:

Page 2 of 9

Index

		Revision history	1
		Index	2
1		Mechanical Specification	3
	1-1	Mechanical Specification(WIFI Antenna)	3
2		Test equipment	4
3		Test Results Summary	5
	3-1	Active Test	5
	3-2	VSWR	5
	3-3	No-source test data	6
	3-4	2D/3D Radiation Pattern Results	7~8
	3-5	Environmental treatment	9

ANTENNA SPECIFICATION

CUS P/N :DR-HTF010S WIFI Antenna
ZTX P/N :DR-HTF010S WIFI Antenna

Application Date:Nov,09,2023
Editor:

Rev: R:A0
Page 3 of 9

1. Mechanical Specification

1-1 Mechanical Configuration (WIFI Antenna)

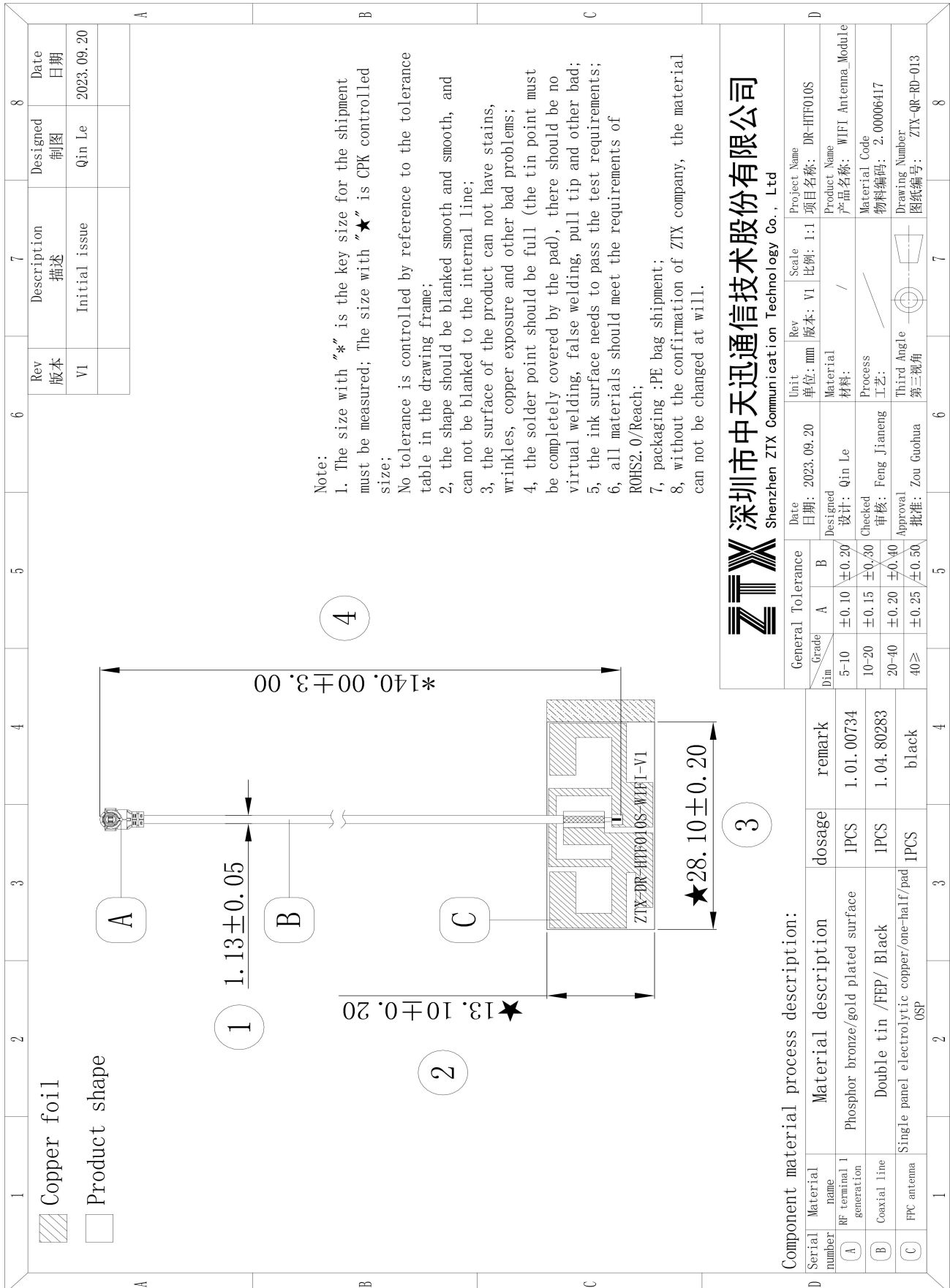

ANTENNA SPECIFICATION

CUS P/N :DR-HTF010S WIFI Antenna
ZTX P/N :DR-HTF010S WIFI Antenna

Application Date:Nov,09,2023
Editor:

Rev: R:A0
Page 4 of 9

2. Test equipment

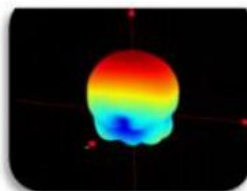
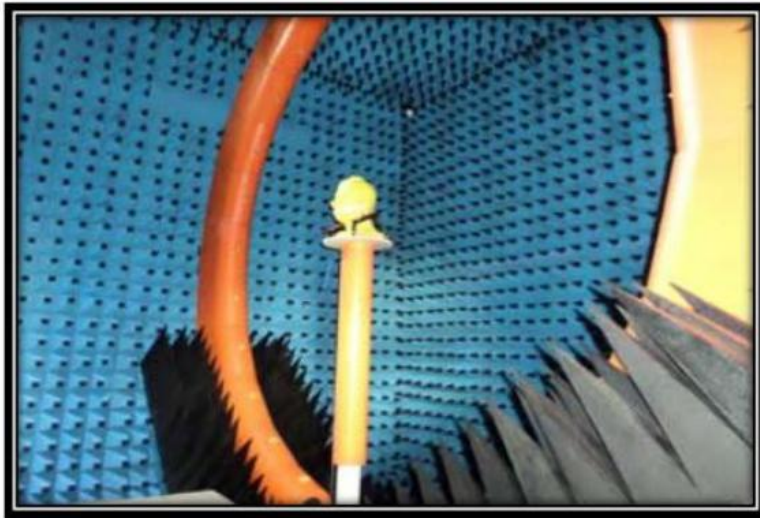

Owned 6 microwave dark room, equipped 2 sets world leading France Satimo SG24 OTA certification test systems (one in SHENZHEN, another one in Shanghai), ETS OTA Standard test system, Blue test reverberation test system which is High repeatability, high accuracy and high resolution. It can quickly provide accurate test reports, fully meet the CTIA standards.

Testing range:

Support active, passive testing of GSM/CDMA/WCDMA/TD-SCDMA/LTE/WIFI/WLAN/WiMax/BT/GPS/MIMO/UWB within 0.4-6G.

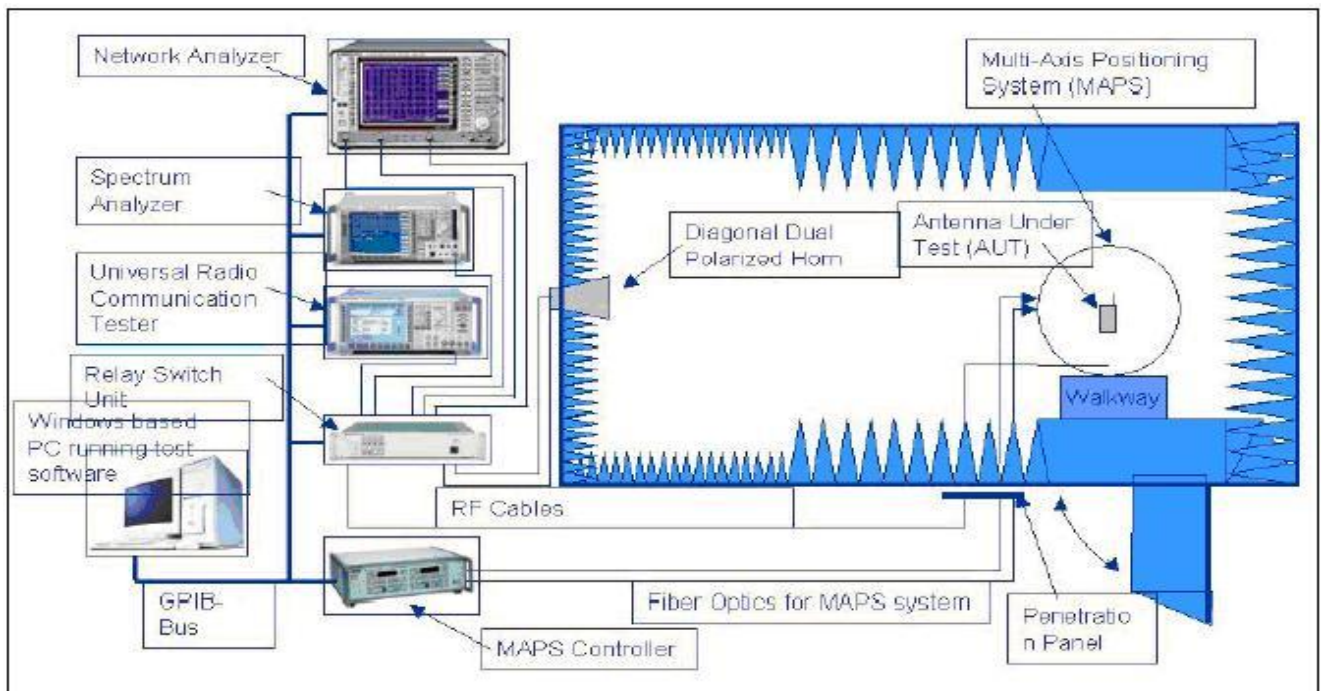

ANTENNA SPECIFICATION

CUS P/N :DR-HTF010S WIFI Antenna
ZTX P/N :DR-HTF010S WIFI Antenna

Application Date:Nov,09,2023
Editor:

Rev: R:A0
Page 5 of 9

3.Test Results Summary 3-1 Active Test

2.4G		
B模	TRP (1M)	TIS (11M)
1	15.97	-84.89
6	15.00	-84.80
11	15.73	-84.39

N模	TRP (MCS0)	TIS (MCS7)
1	13.03	-66.99
6	12.24	-66.12
11	12.54	-66.34

G模	TRP (6M)	TIS (11M)
1	13.77	-71.28
6	12.40	-70.78
11	12.72	-71.34

3-2 VSWR

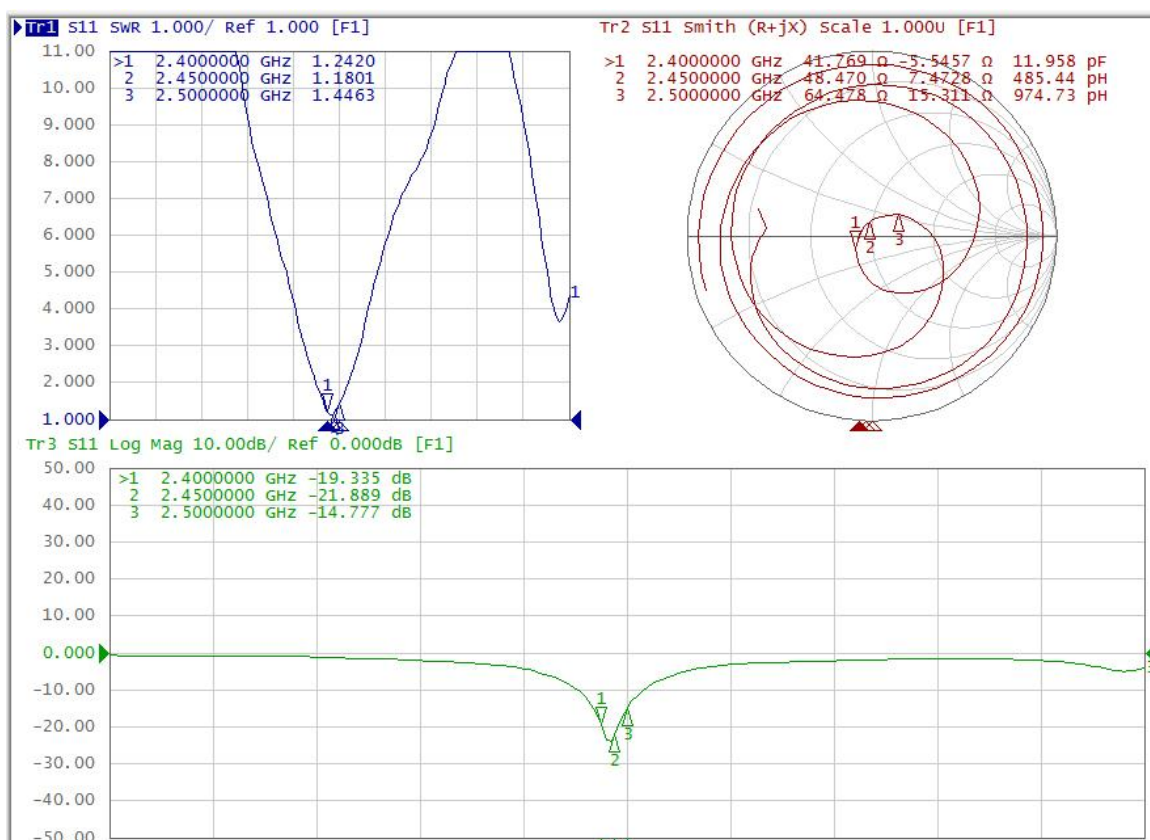

ANTENNA SPECIFICATION

CUS P/N :DR-HTF010S WIFI Antenna

Application Date:Nov,09,2023

Rev: R:A0

ZTX P/N :DR-HTF010S WIFI Antenna

Editor:

Page 6 of 9

3-3 No-source test data

Frequency	Efficiency	Efficiency . dB	Gain . dB
2400	56%	-2.51	3.53
2410	55%	-2.59	3.54
2420	58%	-2.35	3.87
2430	58%	-2.39	3.79
2440	59%	-2.32	3.79
2450	59%	-2.31	3.71
2460	58%	-2.36	3.65
2470	57%	-2.45	3.77
2480	58%	-2.39	3.94
2490	56%	-2.48	3.93
2500	56%	-2.50	3.76

ANTENNA SPECIFICATION

CUS P/N :DR-HTF010S WIFI Antenna
ZTX P/N :DR-HTF010S WIFI Antenna

Application Date:Nov,09,2023
Editor:

Rev: R:A0
Page 7 of 9

3-4 2D/3D Radiation Pattern Results

XOZ面

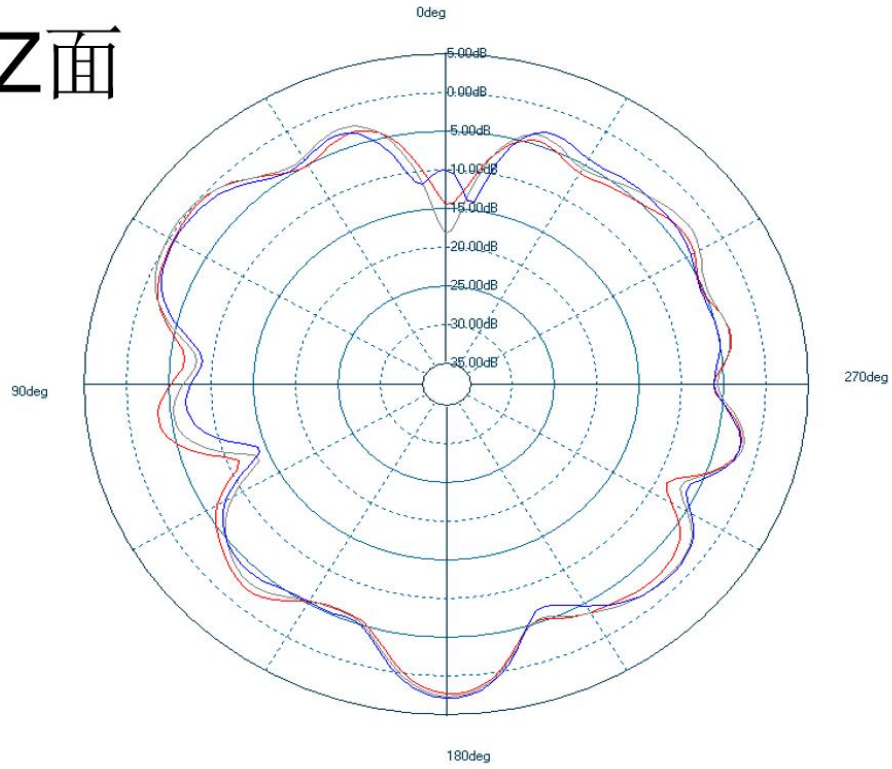

YOZ面

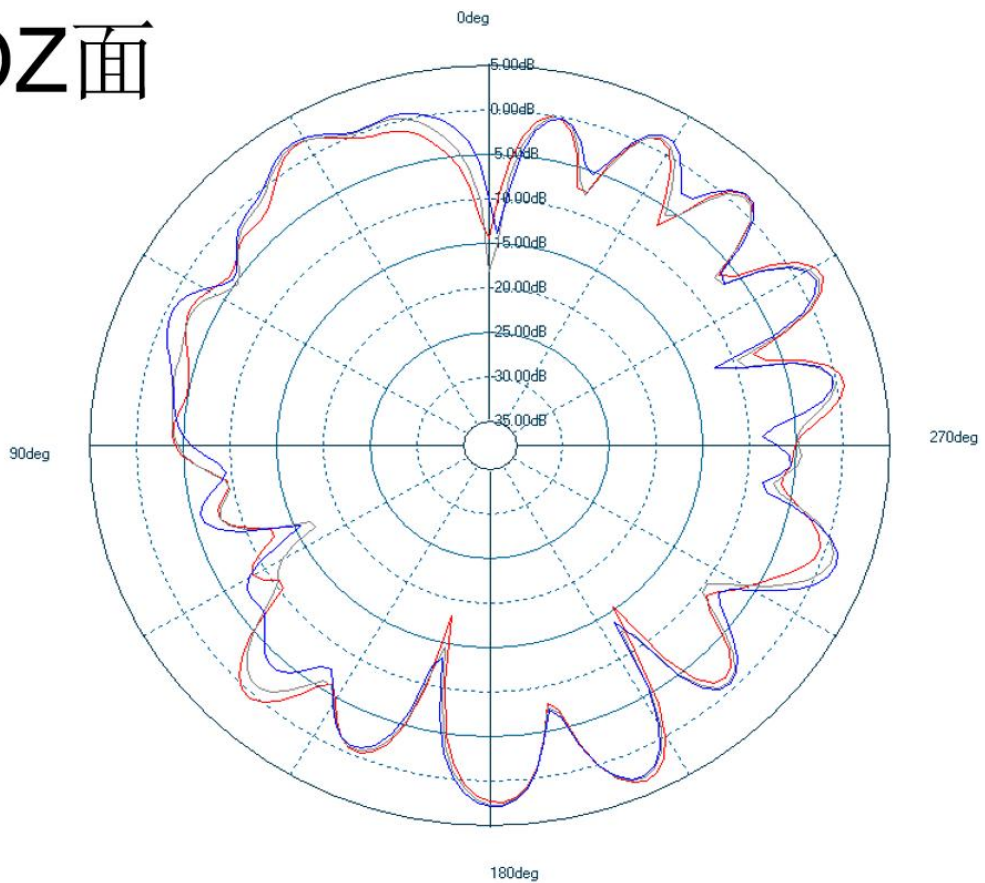

ANTENNA SPECIFICATION

CUS P/N :DR-HTF010S WIFI Antenna
ZTX P/N :DR-HTF010S WIFI Antenna

Application Date:Nov,09,2023
Editor:

Rev: R:A0
Page 8 of 9

XOY面

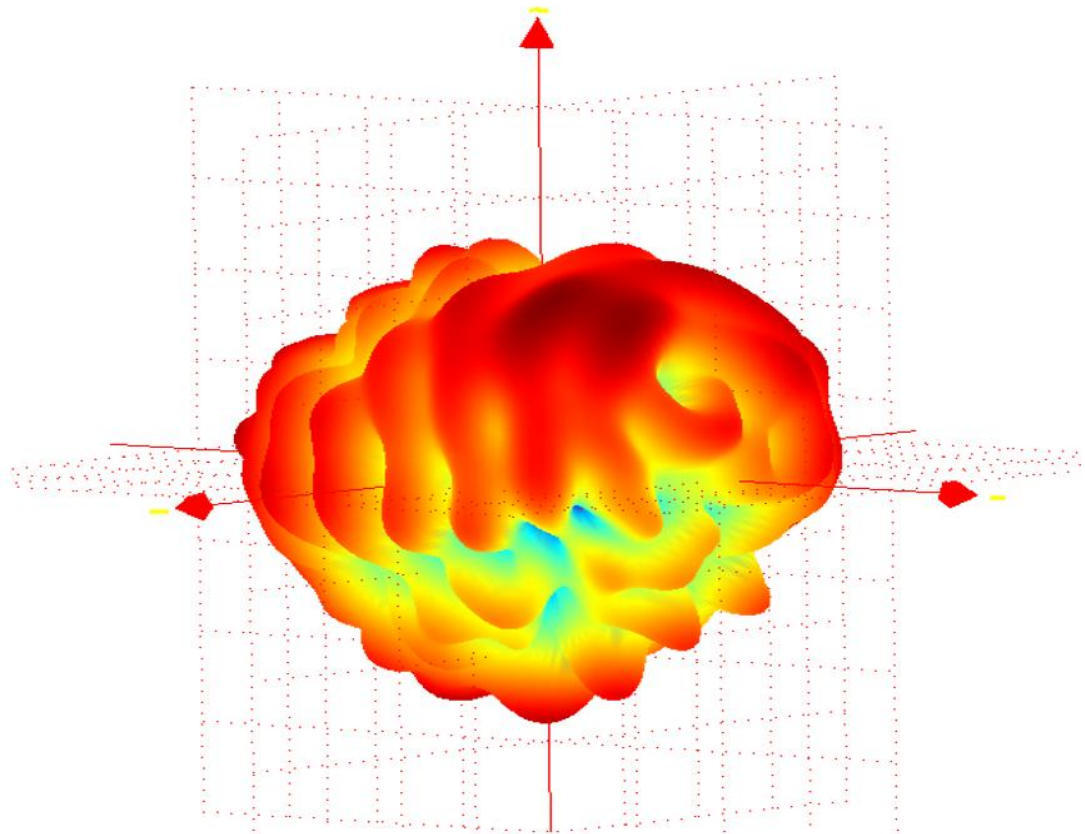
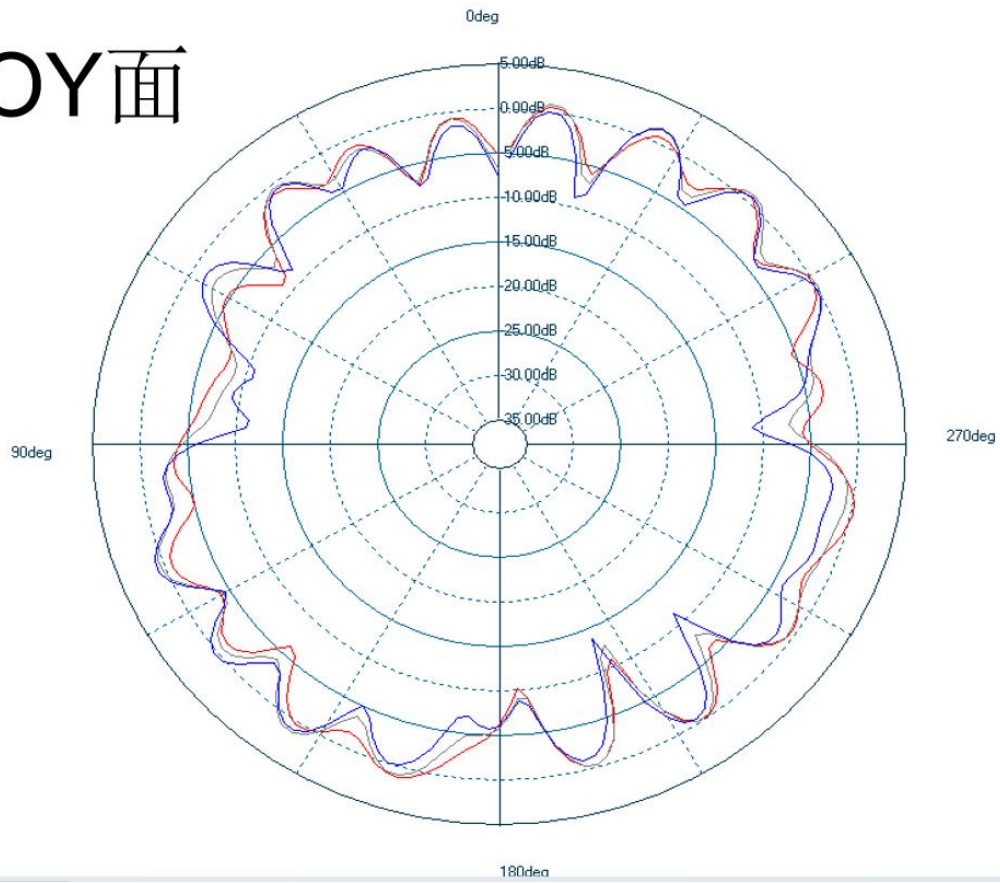

ANTENNA SPECIFICATION

CUS P/N :DR-HTF010S WIFI Antenna

Application Date:Nov,09,2023

Rev: R:A0

ZTX P/N :DR-HTF010S WIFI Antenna

Editor:

Page 9 of 9

3-5 Environmental treatment



Antenna