

设计版本号	产品名称 Product name	比例 scale	日期 Date	设计师 Designer	审核 Audit
Rev_1.2_EN	DR-HSH009S_美观_说明书	1: 1	230717	张依妮	
Hesung Innovation 和创新	材质印刷与 技术要求	封面封底:80g书纸 内页: 80g书纸 印刷要求: 双面印刷, 文字线图清晰 装订方式: 骑马钉装订	字体 Fonts	Manrope	尺寸 Size 105mm × 150mm

*此页删除不做印刷

图纸设计禁止修改, 尺寸刀模图为准

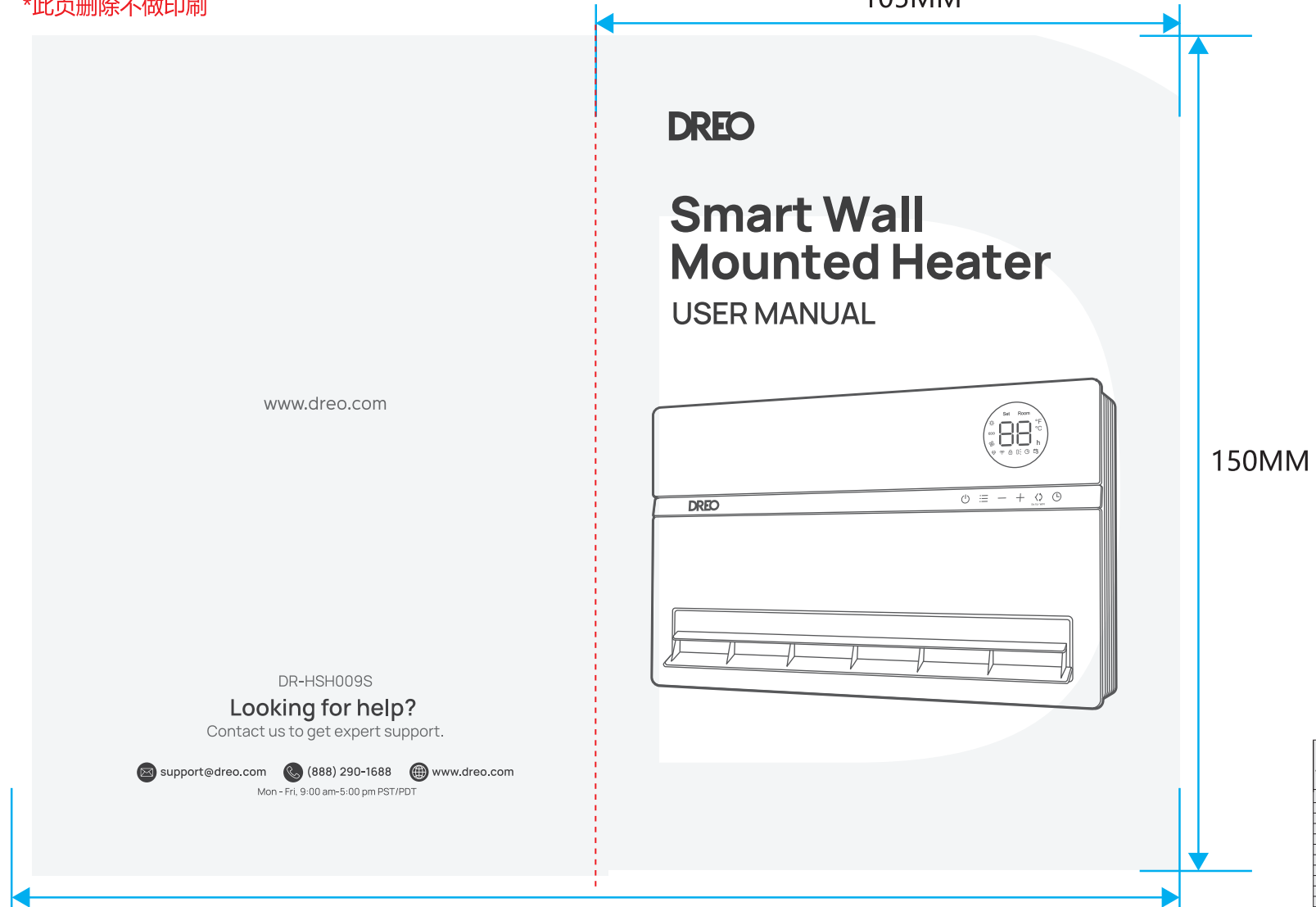

	裁切线
	正折线
	反折线
	出血位
	粘胶区域

<p>图层使用规范:</p> <p>1、备注信息图层为非印刷区域, 展示印刷物料基础信息。 2、刀板线、备注工艺、尺寸层展示印刷工艺部分。 3、画面信息层展示印刷展示图片与文字。</p> <p>*电子文档为Adobe Illustrator制作</p>
<p>文件格式: mode规格类目日期.AI (为可编辑原始文档)</p> <p>文件格式: mode规格类目日期.pdf (为文件转曲不可编辑文档)</p>

<p>审核</p> <p>检查事项</p> <p>全套以“2”形式确认 (含关联“加购确认”)</p> <p>审核检查事项</p> <p>商检规范</p> <p>字符高度</p> <p>工艺材质</p> <p>颜色标识</p> <p>产品文案</p> <p>条码检查</p> <p>厂址</p> <p>金成分</p> <p>警告标注</p> <p>执行标准</p> <p>产品尺寸</p> <p>外/内箱尺寸</p> <p>印刷信息*</p> <p>产品信息</p> <p>产品包装信息</p> <p>请相关部门确认产品、包装等信息!</p> <p>* OEM信息:</p> <p>委托方及被委托方信息 (名称、地址、邮编、电话、生产许可证、卫生许可证)</p>

设计师	审核	产品负责人	法规	采购
-----	----	-------	----	----

DREO

Smart Wall Mounted Heater

USER MANUAL

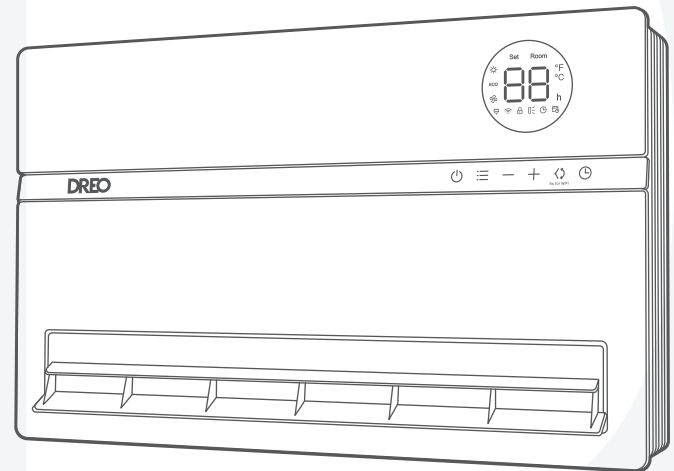

www.dreo.com



DR-HSH009S

Looking for help?

Contact us to get expert support.

 support@dreo.com  (888) 290-1688  www.dreo.com

Mon - Fri, 9:00 am-5:00 pm PST/PDT

//

Thanks for Choosing DREO!

Your support means the world to us. We hope you enjoy our product as much as we did creating it.

EXTEND YOUR WARRANTY FOR FREE

Scan or visit dreo.com/warranty

To extend your warranty for free by registering your product. If you have any product issues, we always stand ready to help.



support@dreo.com



www.dreo.com



(888) 290-1688

Mon - Fri, 9:00 am-5:00 pm PST/PDT

CONTENTS

01

IMPORTANT SAFETY INSTRUCTIONS

2-4

03

INSTALLATION INSTRUCTIONS

6-7

05

USING YOUR HEATER

9-12

07

TROUBLESHOOTING

15-16

02

KNOWING YOUR HEATER

5

04

OPERATING INSTRUCTIONS

8

06

CLEANING AND MAINTENANCE

13-14

08

DREO CUSTOMER CARE

17-18

IMPORTANT SAFETY INSTRUCTIONS

01



When using electrical appliances, basic precautions should always be followed to reduce the risk of fire, electric shock, and injury to persons, including the following:



Do not use the fan heater near flammables and combustibles.

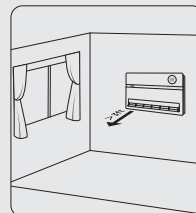

CAUTION - High temperature, risk of fire, keep electrical cords, drapery, furnishings, and other combustibles at least 3 feet (0.9) from the front of the heater and away from the side and rear.

IMPORTANT INSTRUCTIONS

1. Read all instructions before installing or using this heater.
2. This heater is hot when in use. To avoid burns, do not let bare skin touch hot surfaces. Keep combustible materials, such as furniture, pillows, bedding, papers, clothes, etc. And curtains at least 3 feet (0.9m) from the front of the heater and keep them away from the sides (restrictions apply to location dedicated heaters only).
3. Extreme caution is necessary when any heater is used by or near children or invalids and whenever the heater is left operating and unattended.
4. Do not operate any heater after it malfunctions. Disconnect power at service panel and have heater inspected by a reputable electrician before reusing.
5. To disconnect the heater, turn off power from the control panel or remote control, wait for the heater to stop blowing air (about 30 seconds), and unplug the heater from its power outlet.

6. CAUTION: TO PREVENT ELECTRIC SHOCK, MATCH WIDE BLADE OF PLUG TO WIDE SLOT AND FULLY INSERT.

7. In order to avoid overheating, do not cover the heater. It cannot be used in a wardrobe.

8. Do not use outdoors.

9. CAUTION: Whenever the heater is left operating unattended, caution may be necessary if children or invalids are nearby.

10. The appliance should not be used by children or persons with reduced physical, sensory or mental capabilities, or lack of experience and knowledge, unless they have been given supervision or instruction.

11. Do not insert or allow foreign objects to enter any ventilation or exhaust opening as this may cause an electric shock or fire, or damage the heater.

12. Do not operate the outlet fin manually as this may cause malfunction and risk of fire. Always use the control panel, remote control or the Dreo app to change the blowing angle.

13. Unsupervised children should be instructed not to play with the appliance.

14. Do not let children operate the appliance through the Dreo app.

15. To prevent a possible fire, do not block air intakes or exhaust in any manner.

16. Do not operate any heater with a damaged cord or plug or after the heater malfunctions, has been dropped or damaged in any manner. Discard heater, or return to an authorized service facility for examination and/or repair.

17. If the supply cord is damaged, it must be replaced by the manufacturer, its service agent, or similarly qualified persons in order to avoid hazard.

18. A heater has hot and arcing or sparking parts inside. Do not use it in areas where gasoline, paint, or flammable vapors or liquids are used or stored.

19. There is a thermostat limiter inside the heater. When the inner temperature over-heats or abnormal heating occurs, the heater will automatically cut off power supply to avoid risk of fire or damage to the heater.

20. Use this heater only as described in this manual. Any other use not recommended by the manufacturer may cause fire, electric shock, or injury to persons.

21. The output of this heater may vary and its temperature may become hot enough to burn exposed skin. Use of this heater is not recommended for persons with a high sensitivity to heat or an inability to react to avoid burns.

22. Do not attempt to modify or repair the product by yourself. Doing so could void the warranty and cause damage or personal injury. Only a repair technician may disassemble or repair this product.

23. Make sure that no pieces of polystyrene or other packaging material have been left between elements of the appliance. It may be necessary to pass over the appliance with a vacuum cleaner.

24. If the machine is not working as it should, has received a sharp blow, has been dropped, damaged, left outdoors, or dropped into water, do not use and contact Customer Support.

25. Do not run the cord under carpeting. Do not cover the cord with throw rugs, runners, or similar coverings. Do not route cord under furniture or appliances. Place the cord away from high traffic areas. Place the cord where it will NOT cause tripping hazard.

26. Extreme caution is necessary when any heater is used by or near children or invalids and whenever the heater is left operating and unattended.

27. This heater is intended for use as WALL MOUNTED heater only. Failure to properly secure the heater to a flat, level and vertical wall may result in heater malfunction and/or property damage.

28. This heater is not intended for use in bathrooms, laundry areas and similar indoor locations. Never locate heater where it may fall into a bathtub or other water container.

29. CAUTION - High temperature, keep electrical cords, drapery, and other furnishings at least 3 feet (0.9m) from the front of the heater and away from the side and rear.

30. Voltage protection: This heater is intended for 120V outlets only. If heater is plugged in a 240V outlet by mistake, the PCBA will cut off the heating immediately, it will show a "UH" error code, and the heater must be unplugged. The heater will function properly when plugged in the right voltage.

FOR HOUSEHOLD USE ONLY

READ AND SAVE THESE INSTRUCTIONS

SAVE THESE INSTRUCTIONS

Gentle Reminder:

 <p>Check the appliance regularly and refer to TROUBLESHOOTING or contact our customer support if it shows any of the following signs:</p> <ul style="list-style-type: none">- Power cord or plug is damaged.- Loud noise, unusual smell or excessive heat.	Model	DR-HSH009S
	Rated Power	1500W
	Input	120V~60Hz
	Remote Control Battery	CR2025,3V

HOT SURFACE

THE FRONT SURFACE CAN BE VERY HOT DURING USE.
DO NOT TOUCH WHEN IN USE.

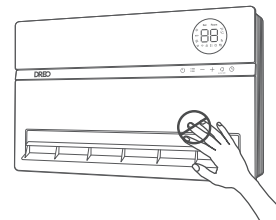

KNOWING YOUR HEATER

02

Package Contents

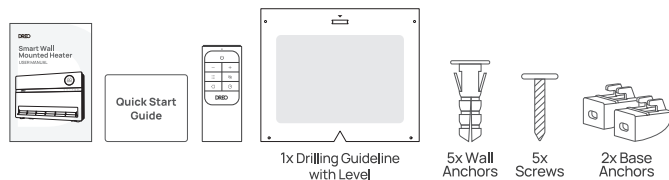
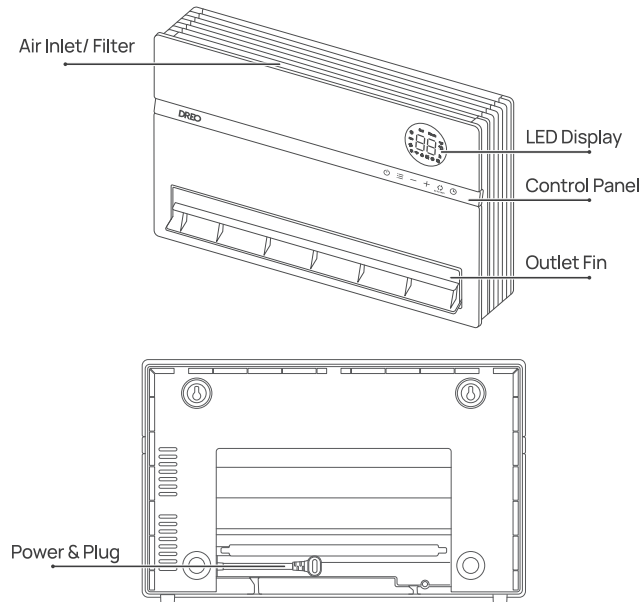

INSTALLATION INSTRUCTIONS

03

THE HEATER MUST BE PROPERLY INSTALLED BEFORE IT IS USED.

CAUTION: YOUR HEATER MUST BE INSTALLED ON A WALL. DO NOT PROP THE HEATER UP AGAINST OBJECTS OR USE THE HEATER WITH THE GRILL PLACED VERTICALLY.

Tools needed for installation:
Electric Drill (5/16 inches, 96mm)
Phillips Screwdriver (5/16 inches, 150mm)
Pencil



Scan the QR code to watch the installation video.

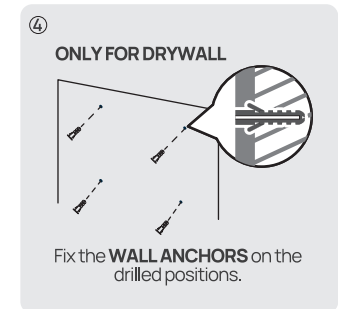
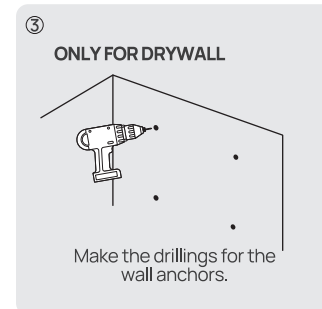
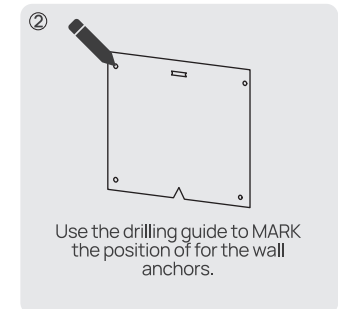
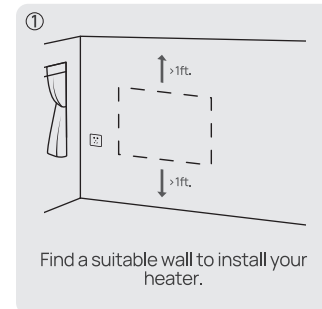

OPERATING INSTRUCTIONS

04

CONNECTING TO YOUR HEATER







Before connecting the appliance to your mobile device, please scan the QR code on the left or go to the app store and search "Dreo", then select and download the app.

This device includes the radio transmitting module whose CMIIT ID is FCC ID: 2A3SYHSH009.



You can use the Dreo app to connect your smart heater to **Amazon Alexa** or **Google Assistant**.

Please follow the in-app instructions to set up your voice assistant.
Note: You must create a Dreo account to access voice assistants.

- 1 Launch Dreo and sign in or create an account by following in-app instructions.
- 2 Enable Bluetooth on your mobile device and plug in your heater.
- 3 Hold the Fan Angle button  for 5s to start WiFi connection settings.
(Tip: The WiFi icon  will keep flashing when pairing.)
- 4 Tap + Add Device and select WH719S.
- 5 Follow in-app instructions to complete WiFi connection.
- 6 You're now ready to control the appliance on your app.
(Tip: To restart connection settings, hold the Fan Angle button  again for 5 seconds.)
Long press 10 seconds power button  to unpair WiFi and restore factory settings.

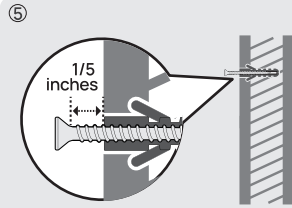

Screw **ONLY THE TWO TOP ANCHORS** first leaving at least a 1/5 inches gap.

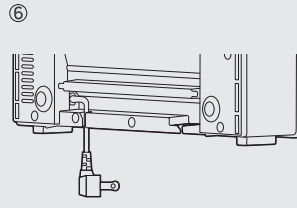

Unfold the power cord.
Note: Make sure the cord can reach the outlet.

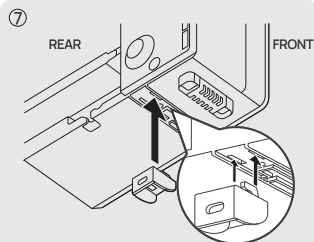

Attach the **TWO BASE ANCHORS** into the bottom of the heater.

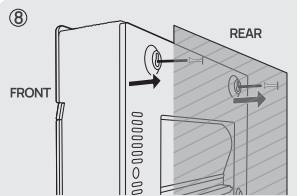

Hang the heater from the top.
Make sure it is firmly hanged before securing the bottom anchors.

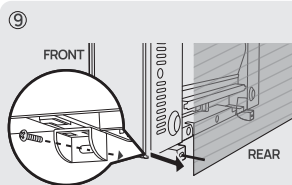

Screw the **BASE ANCHORS** to secure the heater.

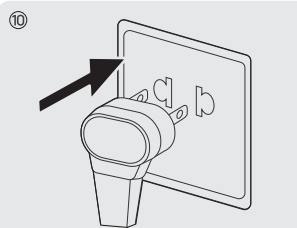

Plug-in the heater.

USING YOUR HEATER 05



CAUTION: Moving the outlet fin manually could lead to malfunction and risk of fire.

Always use the control panel, remote control or the Dreo app to change the blowing angle.

Control Panel



Power On/Off

- Touch to turn the heater on or off.
- Long press for 10s to restore factory settings.

Note:

- When the heater is plugged into the electric outlet, the power indicator  will light in red.



Mode Settings

Touch to switch between **ECO**   .
Long press for 5s to calibrate the thermostat temperature.



Power Heat with three heating levels:
H1(900W), H2(1300W), H3(1500W).



The heater will automatically select its optimal heating power, depending on the difference between the set temperature (41-95°F) and room temperature.

Note:







- When activating ECO Mode, the display will flash the target temperature for 3 seconds.



Fan Only.



Heat Level/ Temperature

- In Power Heat mode, touch  or  to adjust the heating level.
- In ECO mode, touch  or  to adjust the set temperature.
- In Timer mode, touch  or  to set the timer between (0-24h).



Note:

In ECO mode, the heater will flash the °F/°C indicator light and turn off automatically when the set temperature has been reached. If your heater turns off frequently, please raise the set temperature or switch to Power Heat mode.



Timer

- When the heater is on, touch to set a timer (0-24h). After the timer ends, the heater will turn off automatically.
- To cancel, set the timer to "-" hour.
- Long press for 3s to deactivate the schedule function.

Note: You can activate the schedule function through the Dreo app.



Fan Angle

- Touch to change air blowing angle from 120/90/60/Oscillation.
- The LED Display indicates the angle of fan angle accordingly:

 60°

 90°

 120°

 Oscillation

- Long press for 5s to enter WiFi pairing mode (LED WiFi indicator will flash and a countdown will be shown on the display while long pressing.)

Caution: Moving the outlet fin manually could lead to malfunction and risk of fire.

Note: When turning off the heater, it will continue to blow air for 30s to close the air outlet.



Child Lock

- Long press + and - for 3s (LED display will show a countdown) to activate/deactivate Child Lock.

LED Display

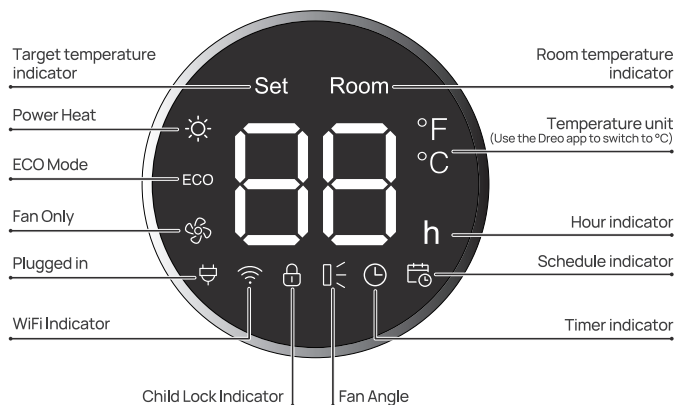

More Features

<p>Display Auto Dimming</p>	<p>In low light conditions, the Led lights will automatically turn off. You may press any button in the control panel, remote control or app to turn lights back on.</p> <p>Note: This function is activated by default, you can turn this feature off/on through the Dreo app.</p>
<p>Mute/Unmute</p>	<p>You can turn off the beep sounds by touching on  your remote control, or in the settings of your Dreo app.</p>
<p>Overheat Protection</p>	<p>When the fin is working abnormally, the appliance will stop heating to avoid risks of fire. (See troubleshooting page 15.)</p>

Thermostat Calibration

This thermostat comes with a built-in thermostat to read room temperatures. If desired, the thermostat on the heater can be calibrated to match your HVAC system using the Dreo app.

Remote Control

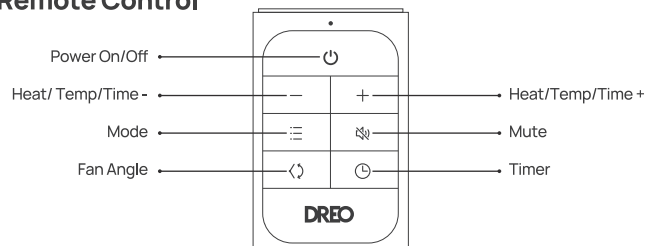

Battery Replacement

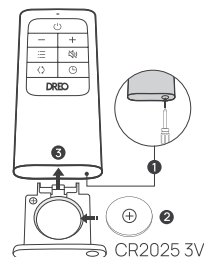

1. Press the locking button to pop out the battery holder.
2. Replace with the same battery type with the (+) side facing up.
3. Push in the holder until securely locked into place

Note: If the indicator on the remote control doesn't turn on anymore, please consider replacing the battery.



WARNING

Chemical Burn Hazard.
Keep batteries away from children.

This product contains a lithium button/coin cell battery. If a new or used lithium button/coin cell battery is swallowed or enters the body, it can cause severe internal burns and can lead to death in as little it can cause severe internal burns and can lead to death in as little the battery compartment does not close securely, stop using the product, remove the battery, and keep it away from children. If you think batteries might have been swallowed or placed inside any part of the body, seek immediate medical attention.

The batteries must be disposed of properly, including keeping them away from children. Even used cells may cause injury.

CLEANING AND MAINTENANCE

06

Cleaning and Maintenance

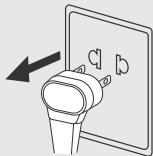

Always turn off and unplug before cleaning.
Wait for the heating element to cool-off before cleaning.

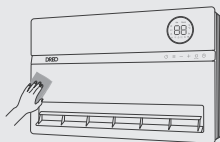

Outer Surface
Use a soft, dry cloth to gently wipe clean the outer surface.

Note: Do not move the outlet fin while cleaning.

Filter Cleaning Recommended once every month.

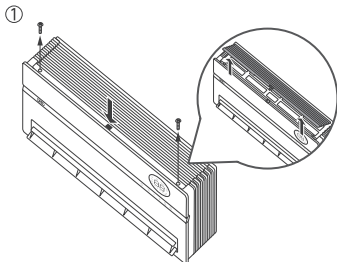

Unscrew both sides and press the center to remove the air inlet cover.

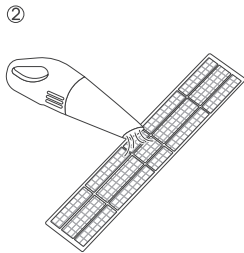

Clean the surface of the air inlet cover and the filter with a handheld vacuum cleaner.

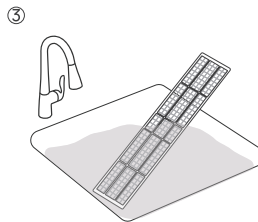

Rinse the air inlet cover and the filter with lukewarm water.

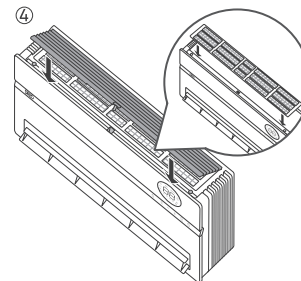

Put the filter back in place, then match the tabs in the cover with the cavities in the heater, then press the center and screw both sides to replace the cover.
Note: Let the filter dry properly before placing it back on the heater.



ATTENTION



DO NOT unscrew the unit.



DO NOT use cleaning agents.



DO NOT use abrasive scrubbers.



Fire or electrical shock hazard, DO NOT immerse the main unit in water. NEVER allow water to get inside the heater.



Except for cleaning, any servicing should be performed by an authorized service representative.



Store in a cool, dry area and keep the cable out of high-traffic areas to avoid tripping hazards.

TROUBLESHOOTING

07

Troubleshooting

Problem	Possible Causes	Solution
Malfunction codes on LED display	F1 - Outlet Fin Protection Error	Wait until the heater cools down to re-start it. Make sure the outlet fin is working properly. If the problem persists, contact Customer Support.
	F2 - Overheat Protection	Unplug and wait for it to cool down before plugging in again.
	BP - Outlet Fin Deviation	Make sure there are no objects obstructing the outlet fin, re-start the appliance. Do not manually adjust the outlet fin angle. If the problem persists, contact Customer Support.
	E0 - PCBA Panel Connection Error	Unplug it from the power source and contact Customer Support.
	E1 - Temperature Sensor Error	Unplug it from the power source and contact Customer Support.

Heater does not start	No power is passing through the unit.	Remove any objects on or near the heater. Ensure that your circuit breaker or fuse is working properly.
	The set temperature is lower than the ambient temperature.	Ensure that the temperature is set to be higher than the ambient temperature.
The heater suddenly stops during heating.	The temperature exceeds the threshold of the thermal cutoff.	Turn off and unplug the unit. Allow it to cool and plug into the electrical outlet again.
	In ECO mode, the heater will turn off automatically when the set temperature has been reached.	This is normal. If your heater turns off frequently, please raise the set temperature or switch to Power Heat mode.
The heater doesn't raise temperature	ECO mode doesn't reach my target temperature.	If you are farther away from your heater, you can raise the target temperature or switch to Power Heat mode.

If your problem is not listed or still persists, contact our Customer Support (see page 17).

DREO CUSTOMER CARE

08

Default 12-Month Warranty

This appliance is covered by Dreo warranty for 12 months from the date of its original purchase.

Extend Your Warranty

Extend your warranty by registering your new appliance on our website <https://dreo.com/warranty>.

The warranty will not apply in cases of:

1. Accident, misuse, or repairs performed by unauthorized personnel.
2. Any unit that has been tampered with or used for commercial purposes.
3. Normal wear and tear of wearable parts.
4. Use of force, damage caused by external influences.
5. Damage caused by non-observance of the User Manual, e.g. connection to an unsuitable mains supply or noncompliance with the instructions.
6. Partially or completely dismantled appliances.
7. Defects caused by or resulting from damages from shipping or from repairs, service, or alteration to the product or any of its parts that have been performed by a repair person not authorized by Dreo.

We can only provide after-sales service for products that are sold by Dreo or Dreo authorized retailers and distributors. If you have purchased the appliance from a different place, please contact your seller for return and warranty issues.

FCC Statement

This device complies with Part 15 of the FCC Rules.

This equipment has been tested and found to comply with the limits for a Class B digital device, pursuant to Part 15 of the FCC Rules. These limits are designed to provide reasonable protection against harmful interference in a residential installation. This equipment generates, uses and can radiate radio frequency energy and, if not installed and used in accordance with the instructions, may cause harmful interference to radio communications. However, there is no guarantee that interference will not occur in a particular installation.

Please note that changes or modifications of this product is not expressly approved by the party responsible for compliance could void the user's authority to operate the equipment.

If this equipment does cause harmful interference to radio or television reception, which can be determined by turning the equipment off and on, the user is encouraged to try to correct the interference by one or more of the following measures:

- Reorient or relocate the receiving antenna.
- Increase the separation between the equipment and receiver.
- Connect the equipment into an outlet on a circuit different from that to which the receiver is connected.
- Consult the dealer or an experienced radio/TV technician for help.

This device complies with Part 15 of the FCC Rules. Operation is subject to the following two conditions: (1) this device may not cause harmful interference, and (2) this device must accept any interference received, including interference that may cause undesired operation.

This equipment complies with FCC radiation exposure limits set forth for an uncontrolled environment. This equipment should be installed and operated with a minimum distance of 20cm between the radiator & your body. This transmitter must not be co-located or operating in conjunction with any other antenna or transmitter.

We're Here to Help!

- ✉ support@dreo.com 🌐 www.dreo.com
- ☎ (888) 520-3736 Mon - Fri, 9:00 am-5:00 pm PST/PDT
- 🏢 Shenzhen Hesung Innovation Technology Co., LTD
- 📍 26F, Bldg A7, Creative City, Shenzhen, China



Rev_1.0_EN