

设计版本号	产品名称 Product name	比例 scale	日期 Date	设计师 Designer	审核 Audit	
Rev_V0_EN	DR-HHM008S_美规说明书	1:1	20240715	Beryl	Alyssa	
Hesung Innovation 和生创新	材质印刷与 技术要求	封面封底:80g书纸 内页:80g书纸 印刷要求:双面印刷,文字线图清晰 装订方式:骑马钉装订	字体 Fonts	Manrope	尺寸 Size	105mm × 150mm

*此页删除不做印刷

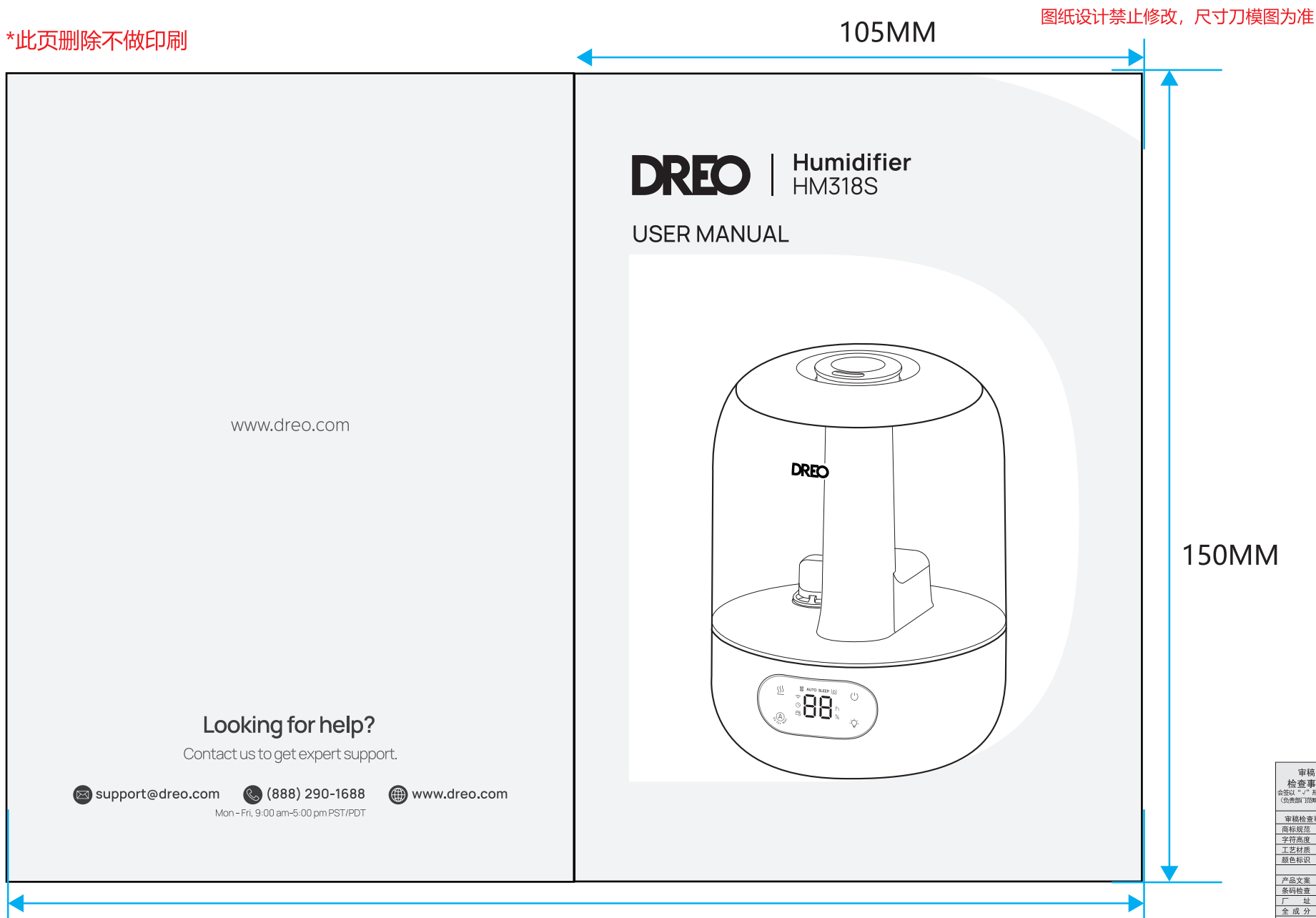

	裁切线
	正折线
	反折线
	出血位
	粘胶区域

图层使用规范:
1、备注信息图层为非印刷区域, 展示印刷物料基础信息。 2、刀板线、备注工艺、尺寸层展示印刷工艺部分。 3、画面信息层展示印刷展示图片与文字。 *电子文档为Adobe Illustrator制作
文件格式: model规格类自日期.AI (为可编辑原始文档) 文件格式: model规格类自日期.pdf (为文件转曲不可编辑文档)

审核
审核事项 会议议“”形式确认 (负责部/页/项/项)
审核检查事项
商标规范
字符高度
工艺材质
颜色标识
产品文案
条码检查
厂址
全成分
警告标语
执行标准
产品尺寸
外/内箱尺寸
OEM信息*
产品包装信息
请相关部门确认产 品、包装等信息!
*OEM信息: 委托方及被委托方 信息(名称、地址、 邮编、电话、生产 许可证、卫生许可 证)

设计师	审核	产品负责人	法规	采购
-----	----	-------	----	----

DREO

Humidifier HM318S

USER MANUAL

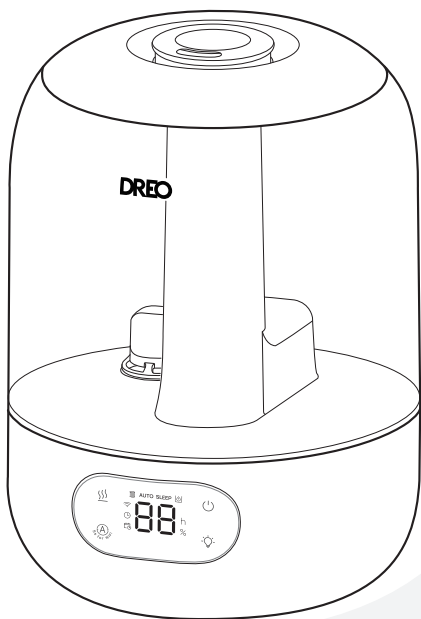

”

Thanks for Choosing **DREO!**

Your support means the world to us.
We hope you enjoy our product as much as
we did creating it.

CONTENTS

01

IMPORTANT SAFETY
INSTRUCTIONS

1-2

02

KNOWING YOUR
HUMIDIFIER

3-5

03

CONNECTING TO
YOUR HUMIDIFIER

6

04

USING YOUR HUMIDIFIER

7-8

05

CLEANING AND
MAINTENANCE

9-13

06

TROUBLESHOOTING

14-15

07

DREO CUSTOMER
CARE

16-18

IMPORTANT SAFETY INSTRUCTIONS

01



READ ALL CAUTIONARY MARKINGS ON THE APPLIANCE AND SAFETY INSTRUCTIONS IN THE USER MANUAL BEFORE USE.



DO NOT block or cover the nozzle while in operation.



DO NOT touch or hold the mains plug with wet hands.



DO NOT let children or pets play with this appliance.

GENERAL SAFETY

- 1.Children shall not play with the appliance. Cleaning and maintenance shall not be performed by children without supervision.
- 2.Use the appliance as described in the user manual only. Any other use not recommended in the user manual may cause fire, electrical shock, or personal injury.
- 3.This appliance can be used by children aged above 8 years and persons with reduced physical, sensory or mental capabilities or lack of experience and knowledge if they have been given supervision or instruction concerning use of this appliance in a safe way and understand the hazards involved.

LOCATION SAFETY

- 1.Always place this appliance on a firm, flat and level surface to avoid dropping or tilt.
- 2.Always place this appliance 2 feet (60cm) above the floor, 12 inches (30cm) away from the wall or wooden furniture.
- 3.DO NOT move this appliance while it is on.
- 4.DO NOT attempt to repair any parts on this appliance. Doing so will void your warranty. The inside of this appliance contains no user serviceable parts., All servicing should be performed by qualified personnel only.

Electricity Safety

1. Make sure that the voltage of your electricity supply is the same as that indicated on the appliance.
2. Always unplug before cleaning or leaving the appliance unused for a long period of time. Keep your hands dry when plugging/unplugging.
3. To avoid fire hazard, NEVER put the cord under rugs, near heat registers, radiator, stoves or heaters.
4. Do not use this appliance if the cord has been damaged to avoid fire or electric hazard.
5. Keep the cord out of heavy traffic areas and where it will not be tripped over.
6. Do not operate any humidifier with a damaged cord or plug. Discard the appliance or return to an authorized service facility for examination and/or repair.
7. Do not run cord under carpeting. Do not cover cord with throw rugs, runners, or similar coverings. Do not route cord under furniture or appliances. Arrange cord away from traffic area and where it will not be tripped over.
8. **WARNING:** To reduce the risk of fire or electric shock, do not use this humidifier with any solid-state speed control device.
9. This appliance has a polarized plug (one blade is wider than the other). To reduce the risk of electric shock, this plug is intended to fit in a polarized outlet only one way. If the plug does not fit fully in the outlet, reverse the plug. If it still does not fit, contact a qualified electrician. Do not attempt to defeat this safety feature.

FOR HOUSEHOLD USE ONLY

Gentle Reminder



Check the appliance regularly and refer to TROUBLESHOOTING or contact our customer support if it shows any of the following signs:

- Power cord or plug is damaged.
- Loud noise, unusual smell or excessive heat.

Specifications

Model	DR-HHM008S
Input	120V 60Hz
Rated Power	29W
Water Tank Capacity	1.06 Gal (4L)

KNOWING YOUR HUMIDIFIER

02

Package Contents

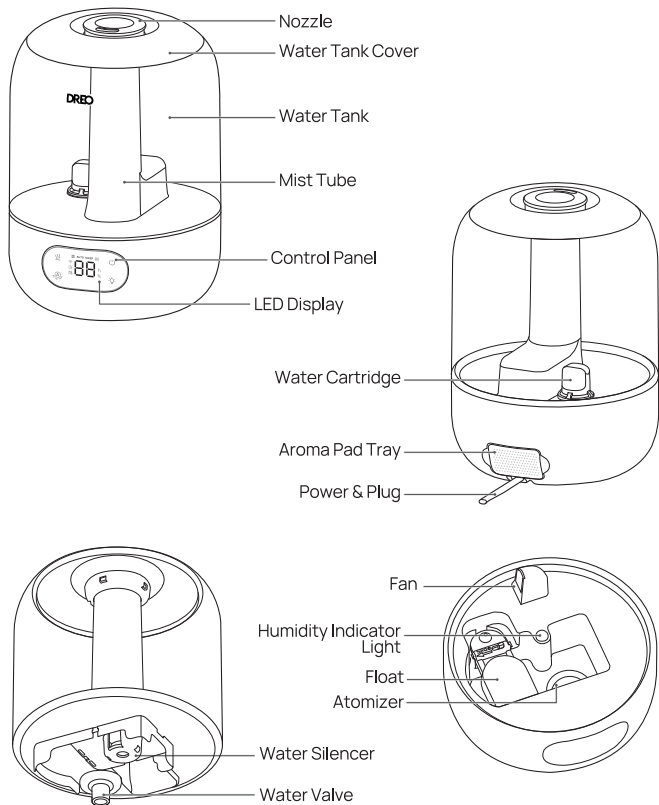



User Manual

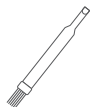

Cleaning Brush



Quick Start Guide



Aroma Pad



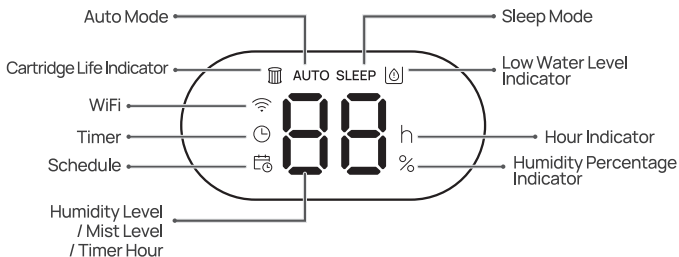



LED Display



Note:

- When humidity levels are below 10%, the display will show "LO".
- When humidity levels are above 90%, the display will show "HI".
- When the water is low, the Low Water Level Indicator will flash for 5 seconds then the humidifier will switch to standby.
- When receiving Software upgrades, the display will show "UP", and the humidifier can't be operated until the upgrade ends.
- You can activate/deactivate Sleep Mode through the DREO app.

Control Panel

 Power Button	<ul style="list-style-type: none">- Turn the humidifier on/off.- Long press for 7s to restore WiFi and factory settings.
 Manual Mode Button	Switch between Low/Medium/High mist level
 Auto Mode Button	<ul style="list-style-type: none">-Turn Auto Mode on Long press 5s to enter WiFi settings-When first activated, the screen will display the target humidity.-Tap the  button to increase the target humidity by 5% (target humidity range from 30% to 90%.)-In Auto Mode, mist level is adjusted according to your target humidity.- Press the Manual Mode Button  to exit Auto Mode.
 Humidity Indicator Light	<ul style="list-style-type: none">- Turn the humidity indicator light on/off You can turn off the beep sounds using the humidity indicator light button or through the Dreo app.- Long press for 5s to start cartridge life countdown. You can check the cartridge life percentage through the Dreo app.

Humidity Indicator Light

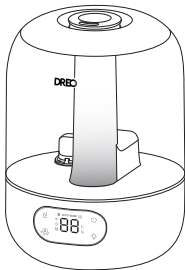

The indicator light will change according to your room humidity level.

Light Color	Humidity Level
Yellow	$\leq 30\%$
Green	31% - 60%
Blue	$\geq 61\%$

CONNECTING TO YOUR HUMIDIFIER

03



Before connecting the appliance to your mobile device, please scan the QR code on the left or go to the app store and search “DREO”, then select and download the app.

FCC ID: 2A3SYHHM008

Look for “HM318S” when connecting your new humidifier.



Download on the
App Store







GET IT ON
Google Play



You can use the DREO app to connect your smart appliance to **Amazon Alexa** or **Google Home**. Please follow the in-app instruction to set up your voice assistant.

NOTE: You must create a DREO account to access voice assistants.

- 1 Launch DREO and sign in or create account by following in-app instructions.
- 2 Enable Bluetooth on your mobile device and plug in your humidifier.
- 3 Hold the Auto Mode button  for 5 seconds to start WiFi connection settings.
(Tip: The WiFi icon  will keep flashing when pairing.)
- 4 Tap **+ Add Device** and select **HM318S**.
- 5 Follow in-app instructions to complete WiFi connection.
- 6 You're now ready to control the appliance on your app.
(Tip: To restart connection settings, hold the  button again for 5 seconds. Long press the power button  for 7s to unpair WiFi and restore factory settings.)

USING YOUR HUMIDIFIER

04

Before Use

When using your humidifier for the first time, remove the wraps and follow the steps below.

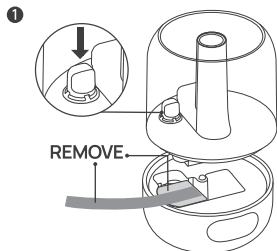

Make sure the water cartridge is installed correctly and the wrap has been removed.

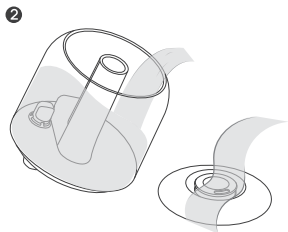

Detach the cover and water tank from the humidifier and clean thoroughly.

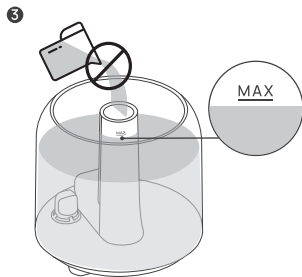

Fill the tank with water, making sure the water doesn't pass the MAX line.
Note: DO NOT add water into the mist tube.

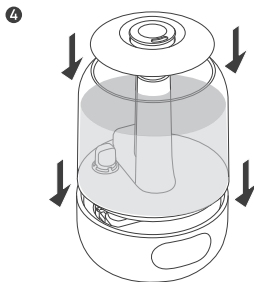

Put the water tank back in place and close the top cover.

5

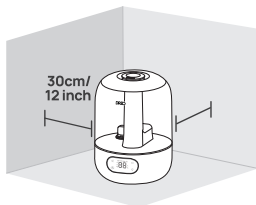

Place the humidifier on a flat, level surface, keeping at least 30 cm / 12 inch away from walls or any major obstacles.

ATTENTION:

- It is recommended to add purified or distilled water to prevent white powder residue from forming.
- Do not add essential oil into the water tank to avoid damage to the tank.
- Do not place the humidifier on the carpet or floor directly.
- Direct the mist away from walls, furniture and electrical appliances.
- It is recommended to place a water-resistant mat under the humidifier to catch spills and droplets.

Adding Essential Oil

1

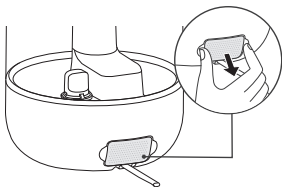

Pull out the aroma pad tray.

2

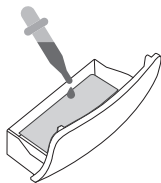

Add 5-10 drops of essential oil on the aroma pad.

3

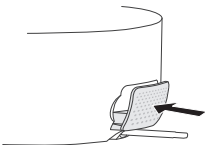

Put the aroma pad tray back in place.

Note:

- Add essential oils on the aroma pad only. Do not add into the water tank or any other places.
- The scent may be soft, this humidifier is not intended to work as an aroma diffuser.
- The scent level cannot be adjusted.
- If the aroma pad becomes too stiff, it needs to be replaced.

CLEANING AND MAINTENANCE

05

Scan the QR code to watch the cleaning and installation video:



- Always turn off and UNPLUG the humidifier before any cleaning or maintenance.
- Do not clean the main body under running water.
- Do not let water splash into the air outlets.
- Do not use any chemical agents when cleaning the humidifier.
- Store in a cool, dry place and cover it to protect from dust.
- Empty and clean the humidifier before storage. Clean the humidifier before next use.
- Do not overfilling the humidifier due to the potential risk of electric shock.

Filling & Refilling

1

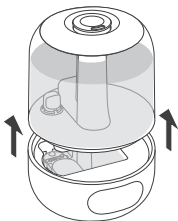

Detach the water tank from the base.

2

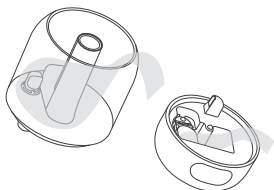

Take out the water tank cover, drain any remaining water from the tank and the base.

3

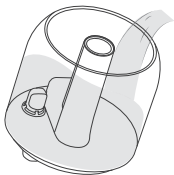

Rinse the tank with warm water.

4



Gently clean the base with a soft cloth or the included cleaning brush.

5



Wipe the tank clean with a soft, damp cloth.

6

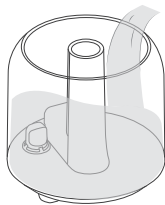

Fill the tank with room temperature water. Do not fill with hot water.

7

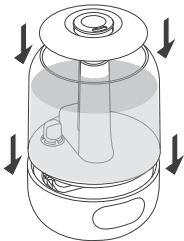

Attach the water tank to the base, replace the top cover.

Descaling

RECOMMENDED ONCE A MONTH

1

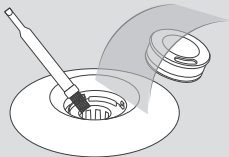

Detach the water tank from the base. Take out the water tank cover and rinse it with warm water.

For a throughout cleaning, you may detach the nozzle from the cover and clean it with the included brush.

2

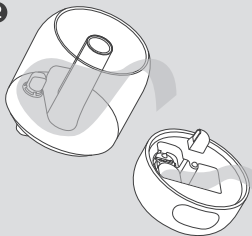

Drain any remaining water from the tank and the base.

3

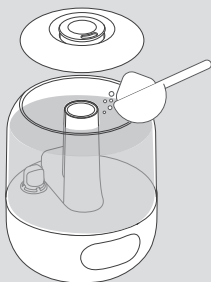

Fill the tank with a solution of bleach and water (one teaspoon of bleach for each gallon of water.) . Replace the tank cover and shake around the tank.

4

15-20min

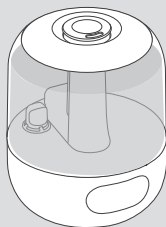

Attach the water tank to the base. Let it sit for 15-20 minutes.

5

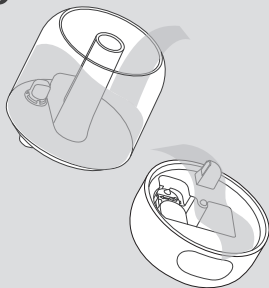

Remove the tank and detach the cover, drain any remaining solution from the tank and the base. Rinse the tank with water until the bleach smell is gone.

6

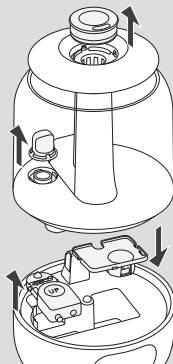

Remove the nozzle, water cartridge, water silencer, and float.

7



Clean all parts with a soft cloth, you may use the included cleaning brush to remove excess of mineral deposit. Make sure all parts are dry before reassembling your humidifier.

Cleaning the aroma pad tray

RECOMMENDED ONCE A WEEK

1

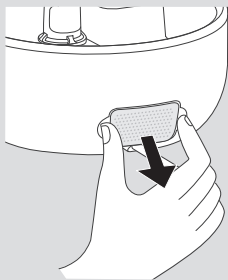

Pull out the aroma pad tray at the back of the base.

2

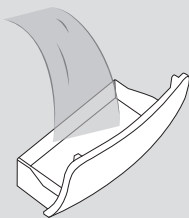

Rinse with water and place back into the base.

Is Your New Humidifier Leaking?

REMOVE

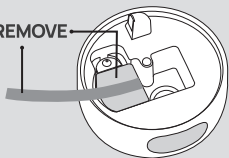

Make sure to remove the wrap.

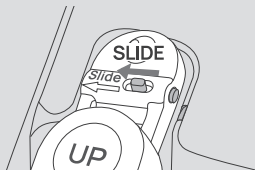

Fix the left prong on the bracket, then slide the other prong to secure the float in place.

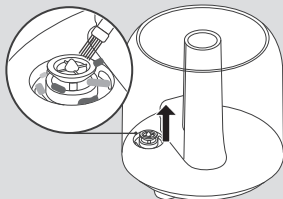

Remove any particles or hair blocking the water valve.

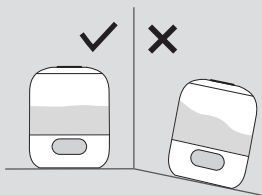

Make sure the humidifier is placed on a flat surface.

Contact Customer Service If...

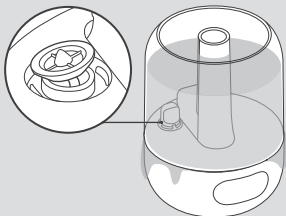

The water valve is not flat or the tank leaks water when refilling.



Your water tank has leakage due to prolonged use of essential oils.

If your humidifier keeps leaking water, please contact customer support (see page 18).

My humidifier does not work.

1. Make sure that the cord is connected to a powered outlet and the mains voltage corresponds with the voltage indicated on the humidifier.
2. The humidifier will shut down automatically in the event of low water.
3. Check if the water tank is installed properly.
4. In Auto Mode, the humidifier will stop adding moisture when it reaches the room humidity target.

My humidifier is not misting.

1. Turn the mist level to a higher setting.
2. The base has too much water. Empty the base and refill the water tank (not the base).
3. Please check whether the air inlet is blocked.
4. Make sure the nozzle is not blocked.
5. Make sure the humidifier is not a flat surface.
6. The water temperature may be too low. Turn the mist level to the highest setting and let it run for a while, then adjust to the desired setting.
7. If the water tank or base have been washed with detergent, rinse thoroughly with clean water to remove any remaining detergent.

There is white dust in the water tank.

You should descale the humidifier regularly. Using purified or distilled water can help prevent the formation of scale.

The mist produces an unpleasant smell.

1. Use purified or distilled water only. It is not recommended to use tap water.
2. Change water regularly to avoid dirty water accumulation.
3. Clean the humidifier and keep it dry for 12 hours with the cover detached.
4. Clean the aroma pad tray, change the aroma pad.

Water leaks from my humidifier.

1. Make sure the silicone sealing ring around the water outlet valve is secure.
2. Avoid running the humidifier in a room with over 60% relative humidity.
3. Wipe any excess water.
4. Do not shake the humidifier.
5. Make sure to place the humidifier on a flat, level surface.
6. Check the water tank for leaks. If there are leaks, contact Customer Support (see page 18).

If your problem is not listed or still persists, contact our Customer Support (**see page 18**).

DREO CUSTOMER CARE

07

Default 12-Month Warranty

This appliance is covered by Dreo warranty for 12 months from the date of its original purchase.

Extend Your Warranty

Extend your warranty by registering your new appliance on our website <https://dreo.com/warranty>.

The warranty will not apply in cases of:

1. Accident, misuse, or repairs performed by unauthorized personnel.
2. Any unit that has been tampered with or used for commercial purposes.
3. Normal wear and tear of wearable parts.
4. Use of force, damage caused by external influences.
5. Damage caused by non-observance of the User Manual, e.g. connection to an unsuitable mains supply or noncompliance with the instructions.
6. Partially or completely dismantled appliances.
7. Defects caused by or resulting from damages from shipping or from repairs, service, or alteration to the product or any of its parts that have been performed by a repair person not authorized by DREO.

We can only provide after-sales service for products that are sold by DREO or DREO authorized retailers and distributors. If you have purchased your unit from a different place, please contact your seller for return and warranty issues.

FCC REQUIREMENT

Any changes or modifications not expressly approved by the party responsible for compliance could void the user's authority to operate the equipment. This device complies with Part 15 of the FCC Rules. Operation is subject to the following two conditions:

- (1) this device may not cause harmful interference, and
- (2) this device must accept any interference received, including interference that may cause undesired operation.

Note: This equipment has been tested and found to comply with the limits for a Class B digital device, pursuant to Part 15 of the FCC Rules. These limits are designed to provide reasonable protection against harmful interference in a residential installation. This equipment generates, uses, and can radiate radio frequency energy, and if not installed and used in accordance with the instructions, may cause harmful interference to radio communications. However, there is no guarantee that interference will not occur in a particular installation. If this equipment does cause harmful interference to radio or television reception, which can be determined by turning the equipment off and on, the user is encouraged to try to correct the interference by one or more of the following measures:

- Reorient or relocate the receiving antenna.
- Increase the separation between the equipment and receiver.
- Connect the equipment into an outlet on a circuit different from that to which the receiver is connected.
- Consult the dealer or an experienced radio/TV technician for help.

This equipment complies with FCC radiation exposure limits set forth for an uncontrolled environment. This equipment should be installed and operated with a minimum distance of 20cm between the radiator & your body. This transmitter must not be co-located or operating in conjunction with any other antenna or transmitter.

ISED Statement

This device contains licence-exempt transmitter(s)/receiver(s) that comply with Innovation, Science and Economic Development Canada's licence-exempt RSS(s). Operation is subject to the following two conditions:

- (1) This device may not cause interference.
- (2) This device must accept any interference, including interference that may cause undesired operation of the device.

L'émetteur/récepteur exempt de licence contenu dans le présent appareil est conforme aux CNR d'Innovation, Sciences et Développement économique Canada applicables aux appareils radio exempts de licence. L'exploitation est autorisée aux deux conditions suivantes :

- 1) L'appareil ne doit pas produire de brouillage;
- 2) L'appareil doit accepter tout brouillage radioélectrique subi, même si le brouillage est susceptible d'en compromettre le fonctionnement.

Safety Exposure

The device meets the exemption from the routine evaluation limits in section 2.5 of RSS 102 and compliance with RSS-102 RF exposure, users can obtain Canadian information on RF exposure and compliance.

Le dispositif rencontre l'exemption des limites courantes d'évaluation dans la section 2.5 de RSS 102 et la conformité à l'exposition de RSS-102 rf, utilisateurs peut obtenir l'information canadienne sur l'exposition et la conformité de rf.

This transmitter must not be co-located or operating in conjunction with any other antenna or transmitter. This equipment should be installed and operated with a minimum distance of 20 centimeters between the radiator and your body.

Cet émetteur ne doit pas être Co-placé ou ne fonctionnant en même temps qu'aucune autre antenne ou émetteur. Cet équipement devrait être installé et actionné avec une distance minimum de 20 centimètres entre le radiateur et votre corps.

Model No.:DR-HHM008S
Rev_1.0_EN

We're Here to Help!

 (888) 290-1688 Mon - Fri, 9:00 am-5:00 pm PST/PDT

 www.dreo.com

 support@dreo.com

 Shenzhen Hesung Innovation Technology Co., LTD

 26F, Bldg A7, Creative City, Shenzhen, China



MADE IN CHINA



Intertek

www.dreo.com

Looking for help?

Contact us to get expert support.



support@dreo.com



[\(888\) 290-1688](tel:(888)290-1688)



www.dreo.com

Mon - Fri, 9:00 am-5:00 pm PST/PDT