



## **Wi-Fi module (XY3721-B2C) specifications**

### **User's Guide**

Version updated 2024-4-23

Confidential, not for distribution without written permission from Rin

Version 1.0

## 1 Product Overview

XY3721\_B2C is a low-power embedded Wi-Fi module developed by Shenzhen Xiyun Technology Co., LTD. It is equipped with Bluetooth 5.2 and Wi-Fi 802.11nA chips, and it can run independently or as a slave to other MCUS. When the module is equipped with external applications and serves as the only application processor in the device, it can be directly launched from the built-in Flash. It also contains low power consumption, up to 160MHz main frequency, built-in 288KB RAM, 2Mbyte flash and rich peripheral resources.

XY3721\_B2C WiFi module supports IEEE 802.11b /g/n protocol standard, BLE5.2, lightweight TCP/IP protocol stack, and supports STA, AP, AP+STA modes. Users can use the module to add networking capabilities to existing devices or to build standalone network controllers. To provide customers with a complete hardware, software reference scheme, in order to shorten your product development cycle, for you to save cost investment.

### 1.1 Features

- Supports 802.11b /g/n/BLE5.2 standard protocols
- Built-in lightweight TCP/IP protocol stack
- Built-in TR switch, Balun, LNA, PA, and integrated onboard antenna  
(compatible with external antenna)
- MCU up to 160M clock rate +288KB RAM
- Built-in 2Mbit Flash
- Support remote firmware OTA upgrade, upgrade can be started through  
the mobile APP, AT command
- Support STAAPAP+STA working mode
- Supports WEP/TKIP/WPA/WPA2 security protocols
- Supports 802.11e and WMM/WMM PS protocols
- Supports Smart Link intelligent networking
- Support HT20
- Supports six hardware PWM channels
- Max output power of +16dBm in Wi-Fi 802.11b mode
- Bluetooth maximum output power +6dBm
- The voltage ranges from 2.7V to 3.6VDC. It is recommended to use 3.3V  
500mA single power supply
- Onboard antenna

## 1.2 Main application field

- Intelligent lighting
- Smart home
- Intelligent sensing
- Smart office
- Intelligent gateway
- Intelligent industry

## 2 Module interface

### 2.1 Dimensional Package

The XY3721\_B2C Wi-Fi module has 2 rows of pins, totaling 11 pins with a 2mm pin spacing. XY3721\_B2C Wi-Fi module size:  $15 \pm 0.35\text{mm}$  (W)  $\times$   $17.95 \pm 0.35\text{mm}$  (L)  $\times$   $3.0 \pm 0.1\text{mm}$  (H), PCB thickness  $0.8\text{mm} \pm 0.1\text{mm}$ , package as shown below:

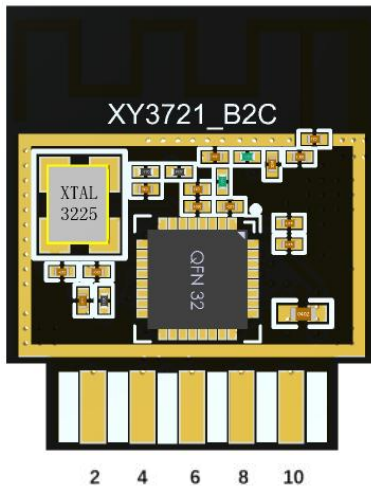

Top view

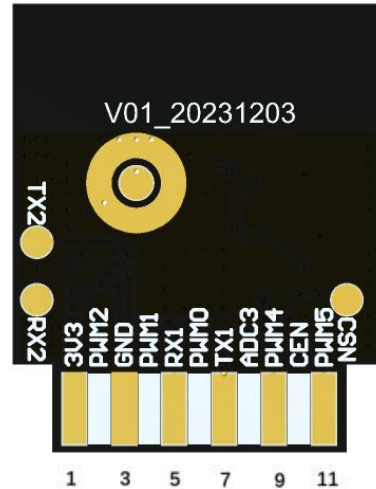

Bottom view

## 2.2 Pin definition

Pin number	syμβo	IO type	Feature
1	VCC	P	Module power supply pin (typical 3.3V)
2	PWM2	I/O	Ordinary IO port, can do LED drive PWM output, corresponding to IC P8, PWM2
3	GND	P	Power reference point
4	PWM1	I/O	Ordinary IO port, can do LED driver PWM output, corresponding to IC P7, PWM1
5	RX1	I/O	Serial port receiving pin UART_RXD1, which can be reused as a common I/O port, corresponding to the P10 of the IC
6	PWM0	I/O	Ordinary IO port, can do LED driver PWM output, corresponding to IC P6, PWM0
7	TX1	I/O	Serial port receiving pin UART_TXD1, which can be reused as a common I/O port, corresponding to P11 of the IC

8	ADC3	I/O	ADC port, which can be reused as ordinary IO, corresponding to the P20 of the IC
9	PWM4	I/O	Ordinary IO port, can do LED driver PWM output, corresponding to IC P24, PWM4
10	CEN	I/O	Module enable pin, internal pull up processing, compatible with other module design docking
11	PWM5	I/O	Ordinary IO port, can do LED driver PWM output, corresponding to IC P26, PWM5
Test point	RX2	I/O	UART_RX2, which corresponds to P1 of IC
Test point	TX2	I/O	UART_TX2, corresponding to P0 of the IC, prints the log port
Test point	CSN	I/O	Common I/O port, corresponding to P15 of the IC

Description: VCC indicates the power supply pin, I/O indicates the input/output pin,

ADC indicates the analog input

## 3 Electrical parameter

argument	Numerical value
Operating frequency	2.4GHz ISM band
Wireless standard	Wi-Fi 802.11n + BLE 5.2
Antenna type	Onboard PCB antenna
Storage temperature	-55°C ~ +125°C
Supply voltage	2.7~3.6V
Electrostatic release voltage (mannequin)	TAMB-25°C 4KV

Electrostatic release voltage (machine model)	TAMB-25°C 0.2KV
Operating voltage	3.3V
Operating temperature	-40°C ~ +85°C

## 3.1 RF Output power

argument	Minimum value	Typical value	Maximum value	unit
Working frequency Wi-Fi	2412		2462	MHz
Operating frequency BLE	2402		2480	MHz
Input impedance		50		Ω

## 3.2 RX receiving sensitivity

argument	Minimum value	Typical value	Maximum value	unit
sensitivity ( 802.11b@11Mbps,CCK )		-88		dBm
sensitivity ( 802.11g@54Mbps,OFDM )		-75		dBm
Sensitivity( 802.11n@HT20,MCS7 )		-72		dBm

Sensitivity ( BLE@1M )		-92		dBm
------------------------	--	-----	--	-----

### 3.3 Transmitting power

argument	Minimum value	Typical value	Maximum value	unit
Output power ( 802.11b@11Mbps )		16	13.13	dBm
BLE Output power ( 802.11g@54Mbps )		17	11.03	dBm
Output power ( 802.11n@HT20,MCS7 )		19	10.80	dBm
Output power ( BLE@1M )		5	9.97	dBm

### 3.4 Power dissipation

The following power consumption data are measured data under 3.3V power supply

condition :

Working condition	mode	speed	Transmit & receive power	Mean value	Peak value (Typical value)	unit
send	802.11b	11Mbps	16dBm	81	270	mA
send	802.11g	54Mbps	15dBm	82	260	mA
send	802.11n	MCS7	14dBm	85	253	mA
receive	802.11b	11Mbps	Continuous	73	73	mA
receive	802.11g	54Mbps	Continuous	75	75	mA



receive	802.11n	MCS7	Continuo us	75	75	mA
---------	---------	------	----------------	----	----	----

## 4 Antenna information

### 4.1 Antenna type

The XY3721\_B2C Bluetooth module uses an onboard PCB antenna

### 4.2 Reduce antenna interference

To ensure optimal RF performance, it is recommended that the distance between the antenna part of the module and other metal parts be at least 15mm. If metal materials are used around the antenna in the environment, the wireless signal will be greatly attenuated, and the RF performance will be deteriorated. Because the module is installed as a plug-in, be sure to reserve enough space for the antenna area.

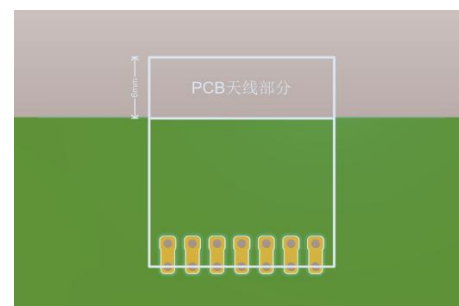
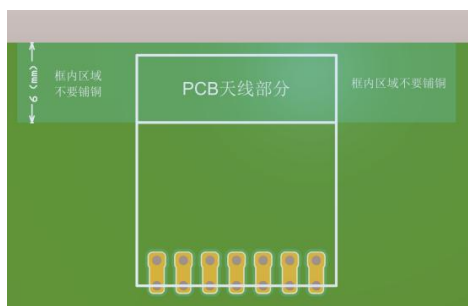

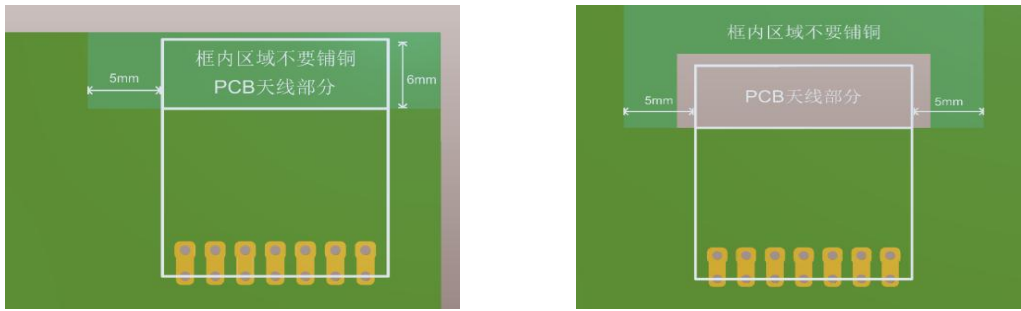

## 5 Module encapsulation

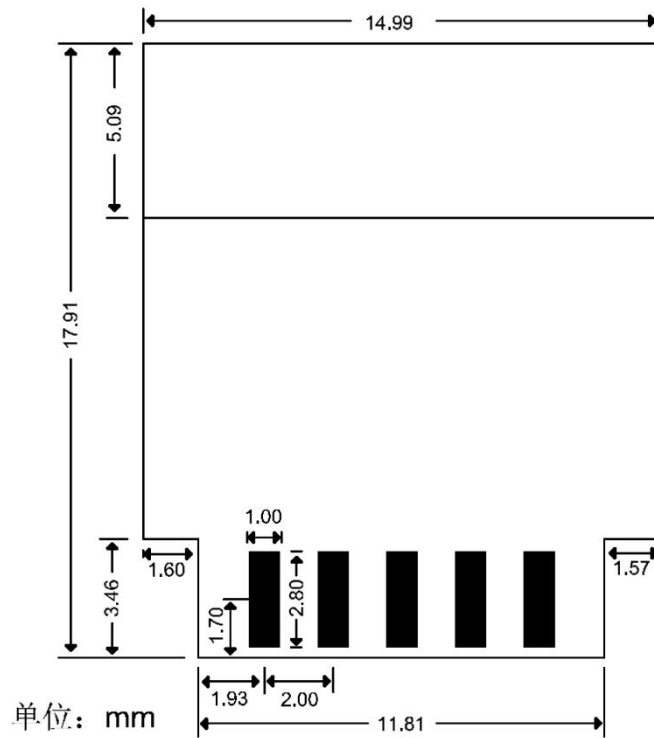

Top view:

Note: The default module dimension tolerance is  $\pm 0.35\text{mm}$ , and the critical dimension

tolerance is  $\pm 0.1\text{mm}$

The circular pad in the left center of the module is the RF test point of the module, and this part of the pad is not drawn in the package library.

## 6 Recommended the furnace

Please apply the SMT patch according to the reflow soldering curve. The peak temperature is  $245^{\circ}\text{C}$ , and the reflow soldering temperature curve is shown in the figure below :

Refer to IPC/JEDEC standard ; Peak Temperature:  $<250^{\circ}\text{C}$  ; Number of Times :  $\leq 2$  times

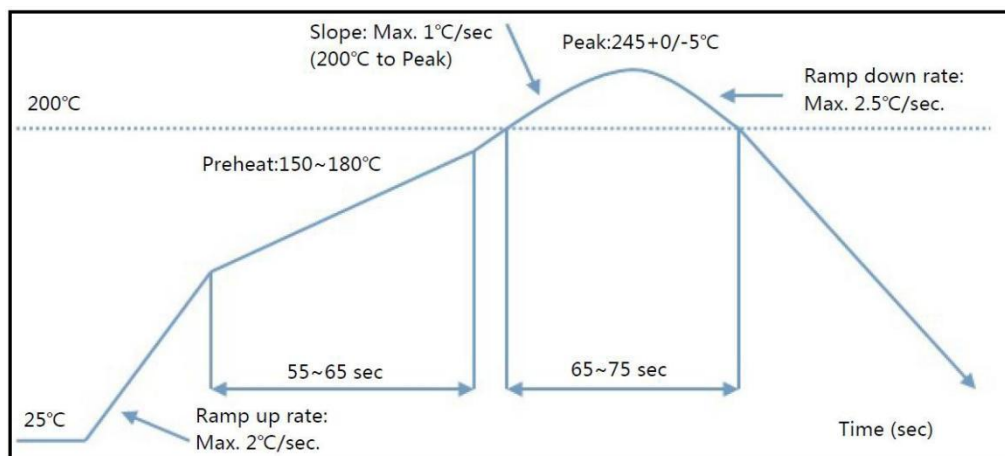

## 7 Module MOQ with packaging information

Product model	MOQ ( PCS )	Shipping packing method	Shipped packing quantity	Number of reels per carton
XY3721-B2C	3600	Carrying reel	900	4

## List of applicable FCC rules FCC Part 15 Subpart C 15.247&15.209

Specific operational use conditions.

The module can be used for mobile applications with a maximum 0.13dBi antenna. The manufacturer installing this module into their product must ensure that the final composite product complies with the FCC requirements by a technical assessment or evaluation to the FCC rules, including the transmitter operation. The host manufacturer has to be aware not to provide information to the end user regarding how to install or remove this RF module in the user's manual of the end product which integrates this module. The end user manual shall include all required regulatory information / warning as shown in this manual.

Limited module procedures. Not applicable.

The module is a Single module and complies with the requirement of FCC part 15.212.

Trace antenna designs. Not applicable.

The module has its own antenna, and doesn't need a host printed board microstrip antenna etc

RF exposure considerations.

The module must be installed in the host equipment such that at least 20cm is maintained between the antenna and user's body, and if RF exposure statement or module layout is changed, then the host product manufacturer is required to take responsibility of the module through a change in FCC ID or new application. The FCC ID of the module cannot be used on the final product. In these circumstances, the host manufacturer will be responsible for evaluating the end product (including the transmitter) and obtaining a separate FCC authorization.

Antennas: Antenna Specification are as follows:

Type: PCB Antenna

Gain: 0.13dBi Max

This device is intended only for host manufacturers under the following conditions: The module shall be only used with the PCB antennas that has been originally tested and certified with this module. The antenna must be either permanently attached or employ a unique antenna coupler. As long as the conditions above are met, further transmitter test will not be required. However, the host manufacturer is still responsible for testing their end-product for any additional compliance requirements required with this module installed for example, digital device emissions, PC peripheral requirements, etc.)

Label and compliance information

Host product manufacturers need to provide a physical or e-label stating "Contains FCC ID: 2A9TO-XY3721-C with their finished product."

Information on the modes and additional testing requirements

Host manufacturer's forms of radiated & conducted emission and spurious emission in all test modes for a stand-alone modular transmitter in host, as well as for multi-silicon ramming modules or other transmitters in a host product. Only when all the test results of test modes comply with FCC requirements, then the end product can be sold legally.

Additional testing, Part 15 subpart B disclaimer. The modular transmitter is only FCC authorized for FCC Part 15 Subpart C 15.247 & 15.209 and that the host product manufacturer is responsible for compliance to any other FCC rules that apply to the host not covered by the modular transmitter grant of certification.

If the grantee markets their product as being Part 15 Subpart B compliant when it also contains unintentional-radiator digital circuitry, then the grantee shall provide a notice stating that the final host product still requires Part 15 Subpart B compliance testing.

**CAUTION:** Any changes or modifications not expressly approved could void the user's authority to operate the equipment.

Any changes or modifications not expressly approved by the party responsible for compliance could void the user's authority to operate the equipment. This device complies with Part 15 of the FCC Rules. Operation is subject to the following two conditions: (1) this device may not cause harmful interference, and (2) this device must accept any interference received, including interference that may cause undesired operation.

Note: This equipment has been tested and found to comply with the limits for a digital device, pursuant to Part 15 of the FCC Rules. These limits are designed to provide reasonable protection against harmful interference in a residential installation. This equipment generates, uses, and can radiate radio frequency energy, and if not installed and used in accordance with the instructions, may cause harmful interference to radio communications. However, there is no guarantee that interference will not occur in a particular installation. If this equipment does cause harmful interference to radio or television reception, which can be determined by turning the equipment off and on, the user is encouraged to try to correct the interference by one or more of the following measures:

- Reorient or relocate the receiving antenna.
- Increase the separation between the equipment and receiver.
- Connect the equipment into an outlet on a circuit different from that to which the receiver is connected.
- Consult the dealer or an experienced radio/TV technician for help.

This equipment complies with FCC radiation exposure limits set forth for an uncontrolled environment. This equipment should be installed and operated with a minimum distance of 20cm between the radiator & your body. This transmitter must not be co-located or operating in conjunction with any other antenna or transmitter.