

# SPECIFICATION

## SHEET FOR APPROVAL

(Revision: R: A0)

CUSTOMER	Hesung Innovation Limited
CS P/N	DR-HAC006S
PART NAME	WIFI Antenna
FREQUENCY	2400~2500MHz
ZTX NO.	2.00000641
DATE	2024-01-08

CUSTOMER			
QA CHECKED	ME CHECKED	RF CHECKED	MANAGER CHECKED

Remark:

Sign:

Shenzhen ZTX Communication Technology Co., Ltd				
MANAGER CHECKED	MANAGER CHECKED	ME CHECKED	RF CHECKED	LISTER
		Youjie Ke	Gang Liu	

 **中天迅**

Shenzhen ZTX Communication Technology Co., Ltd

Address: No.34, Shilong Avenue, Shiyao Town, Baoan District, Shenzhen, (Tengda Industrial Park) 518000

Tel.: 0755-27588320 Fax: 0755-27588045 <http://www.chinaztx.com>

# ANTENNA SPECIFICATION

CUS P/N :DR-HAC006S WIFI Antenna

Application Date:Jan,08,2024

Rev: R:A0

ZTX P/N :DR-HAC006S WIFI Antenna

Editor:

Page 1 of 8

---

## Revision history

Edition	Date	state
A0	2024-01-08	First edition

# ANTENNA SPECIFICATION

CUS P/N :DR-HAC006S WIFI Antenna  
ZTX P/N :DR-HAC006S WIFI Antenna

Application Date:Jan,08,2024  
Editor:

Rev: R:A0  
Page 2 of 8

---

## Index

		<b>Revision history</b>	<b>1</b>
		<b>Index</b>	<b>2</b>
<b>1</b>		<b>Mechanical Specification</b>	<b>3</b>
	<b>1-1</b>	<b>Mechanical Specification(WIFI Antenna)</b>	<b>3</b>
<b>2</b>		<b>Test equipment</b>	<b>4</b>
<b>3</b>		<b>Test Results Summary</b>	<b>5</b>
	<b>3-1</b>	<b>Active Test</b>	<b>5</b>
	<b>3-2</b>	<b>VSWR</b>	<b>5</b>
	<b>3-3</b>	<b>No-source test data</b>	<b>6</b>
	<b>3-4</b>	<b>2D/3D Radiation Pattern Results</b>	<b>7</b>
	<b>3-5</b>	<b>Environmental treatment</b>	<b>8</b>

# ANTENNA SPECIFICATION

CUS P/N :DR-HAC006S WIFI Antenna  
ZTX P/N :DR-HAC006S WIFI Antenna

Application Date:Jan,08,2024  
Editor:

Rev: R:A0  
Page 3 of 8

## 1. Mechanical Specification

### 1-1 Mechanical Configuration (WIFI Antenna)

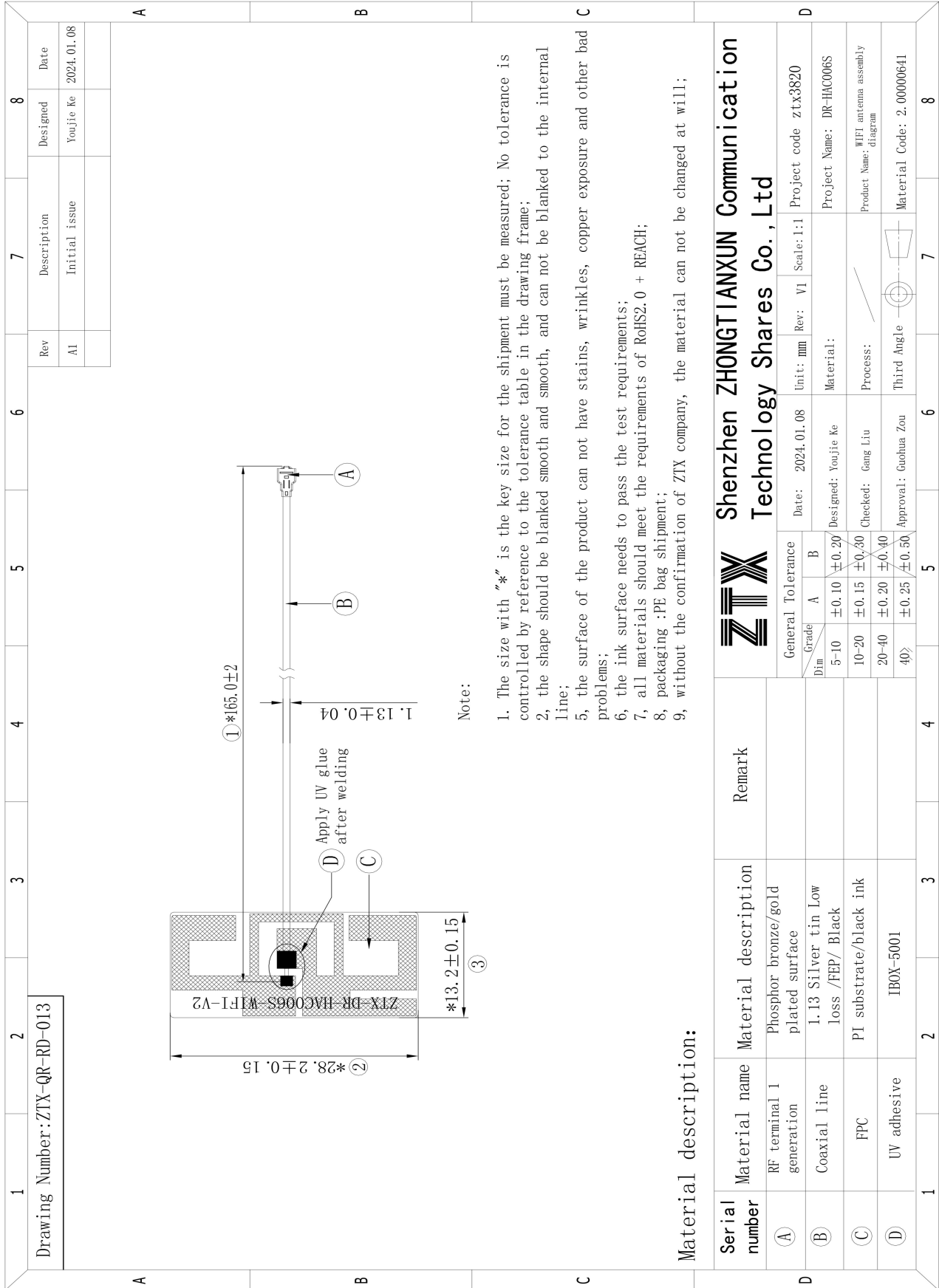

**ZTX** Shenzhen ZHONGTIANXUN Communication Technology Shares Co., Ltd

# ANTENNA SPECIFICATION

CUS P/N :DR-HAC006S WIFI Antenna  
ZTX P/N :DR-HAC006S WIFI Antenna

Application Date:Jan,08,2024  
Editor:

Rev: R:A0  
Page 4 of 8

## 2. Test equipment

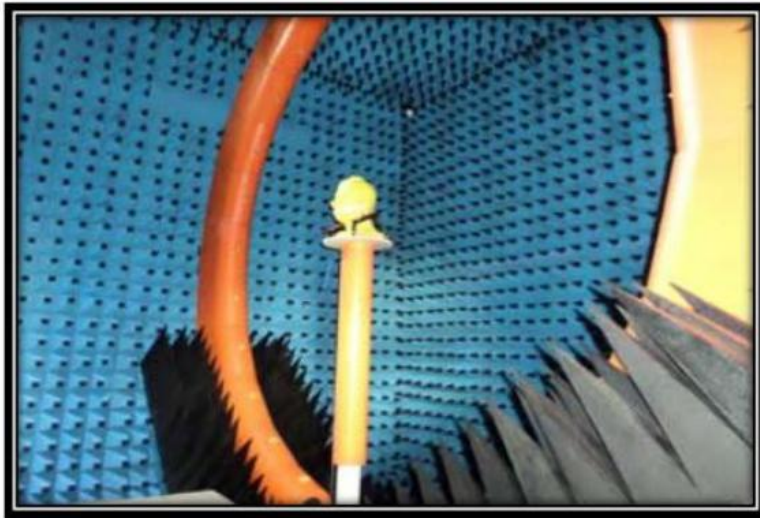

Owned 6 microwave dark room, equipped 2 sets world leading France Satimo SG24 OTA certification test systems (one in SHENZHEN, another one in Shanghai), ETS OTA Standard test system, Blue test reverberation test system which is High repeatability, high accuracy and high resolution. It can quickly provide accurate test reports, fully meet the CTIA standards.

Testing range:

Support active, passive testing of GSM/CDMA/WCDMA/TD-SCDMA/LTE/WIFI/WLAN/WiMax/BT/GPS/MIMO/UWB within 0.4-6G.

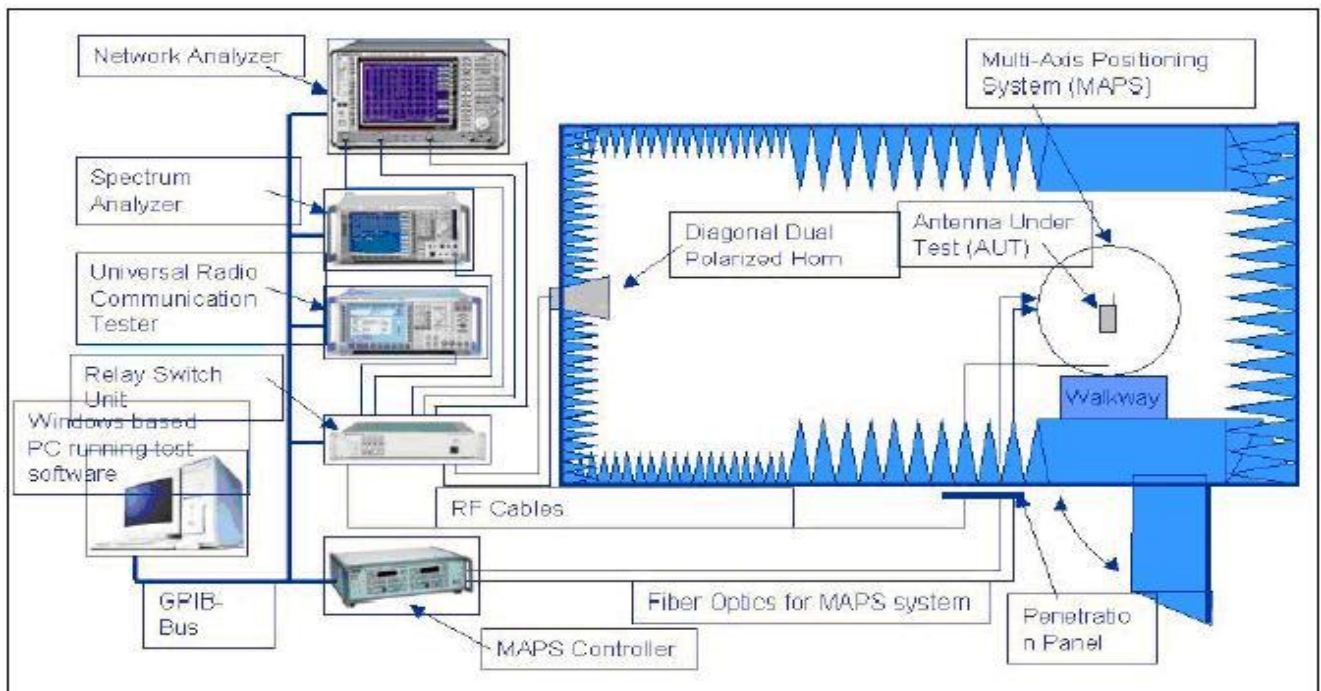

# ANTENNA SPECIFICATION

CUS P/N :DR-HAC006S WIFI Antenna  
ZTX P/N :DR-HAC006S WIFI Antenna

Application Date:Jan,08,2024  
Editor:

Rev: R:A0  
Page 5 of 8

## 3.Test Results Summary 3-1 Active Test

11b	Channels	TRP (11M)	TIS (11M)
	1	15.58	-83.67
	6	15.68	-83.82
	11	15.89	-83.73
11g	Channels	TRP (54M)	TIS (54M)
	1	12.03	-70.78
	6	12.11	-70.77
	11	12.45	-70.86
11n	Channels	TRP (MCS7)	TIS (MCS7)
	1	11.89	-66.44
	6	12.07	-66.53
	11	12.38	-66.88

## 3-2 VSWR

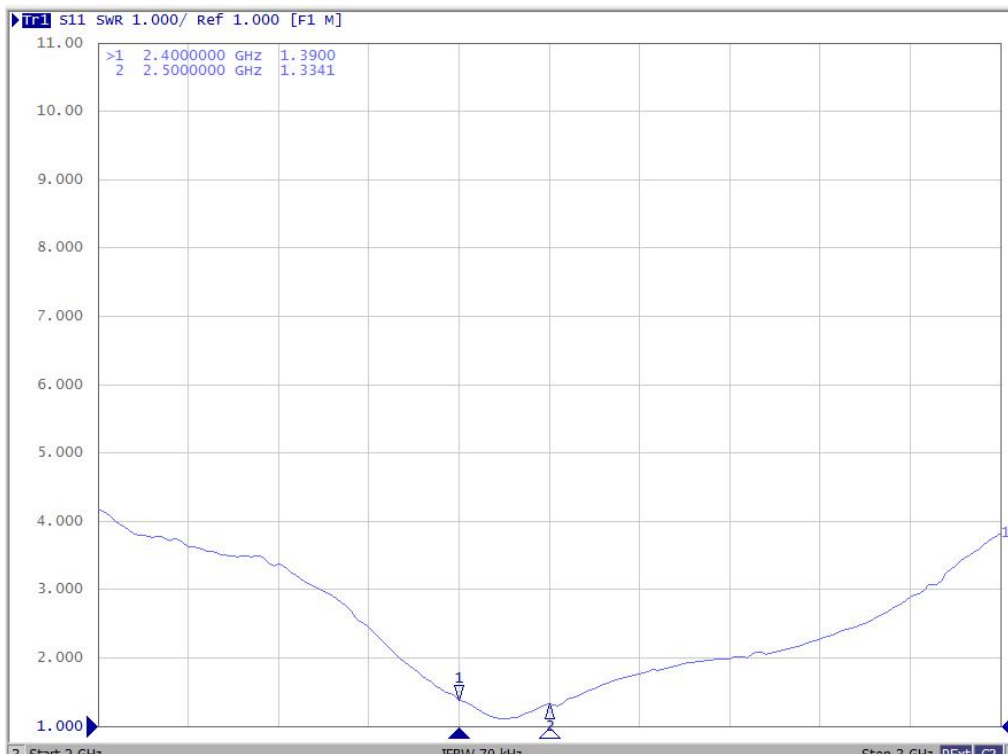

# ANTENNA SPECIFICATION

CUS P/N :DR-HAC006S WIFI Antenna  
ZTX P/N :DR-HAC006S WIFI Antenna

Application Date:Jan,08,2024  
Editor:

Rev: R:A0  
Page 6 of 8

## 3-3 No-source test data

Frequency	Efficiency	Efficiency (dB)	Gain (dB)
2400MHz	63%	-1.98	5.95
2410MHz	64%	-1.95	5.52
2420MHz	65%	-1.85	5.63
2430MHz	66%	-1.83	5.53
2440MHz	65%	-1.89	5.58
2450MHz	65%	-1.86	5.74
2460MHz	66%	-1.83	5.91
2470MHz	65%	-1.88	6.02
2480MHz	65%	-1.89	5.92
2490MHz	64%	-1.96	5.96
2500MHz	63%	-2.01	6.06

# ANTENNA SPECIFICATION

CUS P/N :DR-HAC006S WIFI Antenna  
ZTX P/N :DR-HAC006S WIFI Antenna

Application Date:Jan,08,2024  
Editor:

Rev: R:A0  
Page 7 of 8

## 3-4 2D/3D Radiation Pattern Results

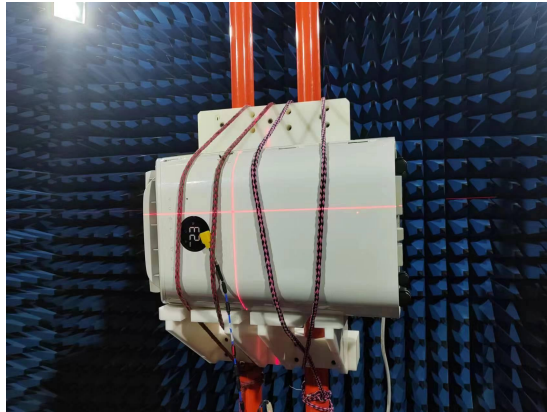

xoy

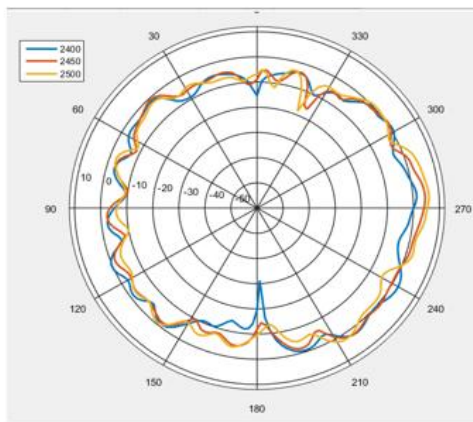

yoZ

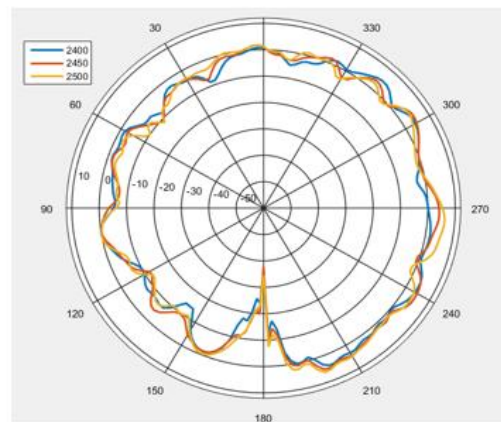

XOZ

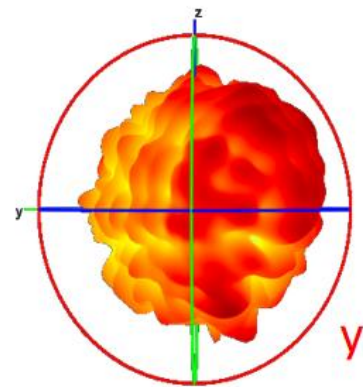
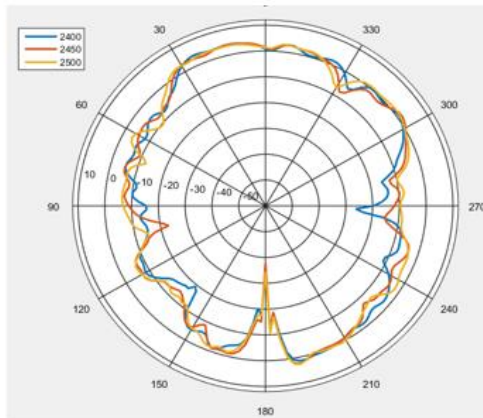



# ANTENNA SPECIFICATION

CUS P/N :DR-HAC006S WIFI Antenna  
ZTX P/N :DR-HAC006S WIFI Antenna

Application Date:Jan,08,2024  
Editor:

Rev: R:A0  
Page 8 of 8

## 3-5 Environmental treatment

