

DREO

5 INCH HD SPLIT SCREEN BABY MONITOR



DREO
www.dreo.com

Looking for help?

Contact us to get expert support.

 (888) 520-3736
Mon - Fri, 9:00 am-5:00 pm PST/PDT

 www.dreo.com

 support@dreo.com

Model: DR-BBM001

USER MANUAL

FCC ID: 2A3SY-BBM001
FCC ID: 2A3SY-BBM001B

// Thanks For Choosing **DREO!**

Your support means the world to us. We hope you enjoy our product as much as we did creating it.

EXTEND YOUR WARRANTY FOR FREE

Scan or visit dreocom/warranty to extend your warranty for free by registering your product. If you have any product issues, we always stand ready to help.



(888) 520-3736

Mon - Fri, 9:00 am-5:00 pm PST/PDT



support@dreocom



www.dreocom



FOLLOW US TO DISCOVER MORE

Find us on social media to stay connected and find new inspiration.

Join the Dreocom community on Facebook:

facebook.com/groups/dreobabycare



IMPORTANT SAFETY INSTRUCTIONS	1		
General Safety	1		
Location Safety	1		
Electricity Safety	2		
FCC Statement	2		
Specifications	3		
KNOWING YOUR BABY MONITOR	4		
Package Contents	4		
Product Diagram	5		
USING YOUR BABY MONITOR	7		
Getting Started	7		
Plugging in the Camera	7		
Charging the Monitor	7		
Pairing the Camera with the Monitor	7		
Positioning the Camera	7		
Wall Mounting the Camera (Optional)	7		
Functions & Operations	8		
Interface Overview	8		
Volume Settings	10		
Brightness Settings	11		
		Screen Timeout	11
		Add a Camera	12
		View a Camera	12
		Delete a Camera	13
		Auto Switch	13
		Split Screen	14
		VOX (Voice Activated Alert)	14
		Nursing Reminder	15
		Talkback	16
		Sleep Mode	16
		Zoom In & Zoom Out	17
		Pan & Tilt	17
		Night Vision	17
		Temperature Alert	18
		Other Settings	18
		TROUBLESHOOTING	19
		DREO CUSTOMER CARE	22

IMPORTANT SAFETY INSTRUCTIONS

READ ALL CAUTIONARY MARKINGS ON THE APPLIANCE AND SAFETY INSTRUCTIONS IN THE USER MANUAL BEFORE USE.

General Safety



Not a Substitute for Proper Adult Supervision:
You MUST check your children's activities regularly.
Not Intended for Use as a Medical Camera:
this appliance should not replace adult supervision.
Not a Toy:
Do not allow children to play with this appliance.
Risk of Suffocation:
Keep all packaging materials out of reach of children.

Location Safety

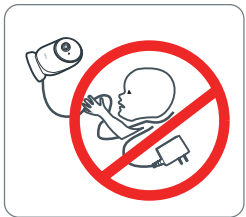
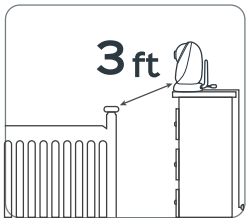

Strangulation Hazard:
Children can be entangled in cords. Keep the appliance, adapter and power cords out of the reach of children at all times, at least 3 feet away.
Danger from Power Cords:
To avoid possible danger from power cords, the cords should be secured and never be hung on or near the crib or playpen. Do not place in the crib, bed or playpen.
Keep Away From Heat:
Do not install near any heat sources such as radiators, heat registers and stoves.
Water and Moisture:
Do not use the appliance near water, including near a bathtub, sink, laundry machine, wet basement, etc.

Electricity Safety

- Only use the AC adapters provided.
- Do not insert anything into upgrade pinholes.
- Do not block any ventilation openings.
- Unplug the appliance during lightening storms.
- Only use attachments and accessories provided.
- Unplug the appliance when unused for long periods of time.

HOUSEHOLD USE ONLY READ AND SAVE THESE INSTRUCTIONS

FCC Statement

Changes or modifications not expressly approved by the party responsible for compliance could void the user's authority to operate the equipment. This device complies with Part 15 of the FCC Rules. Operation is subject to the following two conditions:

this device may not cause harmful interference, and this device must accept any interference received, including interference that may cause undesired operation.

Note: This equipment has been tested and found to comply with the limits for a Class B digital device, pursuant to Part 15 of the FCC Rules. These limits are designed to provide reasonable protection against harmful interference in a residential installation. This equipment generates, uses, and can radiate radio frequency energy, and if not installed and used in accordance with the instructions, may cause harmful interference to radio communications. However, there is no guarantee that interference will not occur in a particular installation. If this equipment does cause harmful interference to radio or television reception, which can be determined by turning the equipment off and on, the user is encouraged to try to correct the interference by one or more of the following measures:

- Reorient or relocate the receiving antenna.
- Increase the separation between the equipment and receiver.
- Connect the equipment into an outlet on a circuit different from that to which the receiver is connected.
- Consult the dealer or an experienced radio/TV technician for help.

FCC 20cm Statement

This equipment complies with FCC radiation exposure limits set forth for an uncontrolled environment. This equipment should be installed and operated with a minimum distance of 20cm between the radiator & your body. This transmitter must not be co-located or operating in conjunction with any other antenna or transmitter.

SPECIFICATIONS

General System

Connectivity	2.4GHz FHSS
RF Frequency	2400 MHz-2483 MHz
Type of Modulation	GFSK
Selectable Camera Channels	4

Monitor

Resolution	1280 X 780P
Display	5 inch TFT Color Display
Input Voltage	100-240V~50/60Hz
Operating Voltage	5.0V==2A
Battery	5000mAh
Zoom	2X&4X

Camera

COMS	1280 X 720P
Input Voltage	100-240V~50/60Hz
Operating Voltage	5V==1.2A
Night Vision	Black and white
Pan & Tilt	90 degrees vertical (up=60°, down=30°) 300 degrees horizontal

Gentle Reminder

Check the appliance regularly and refer to TROUBLESHOOTING or contact our customer support if it shows any of the following signs:

- Power cord or plug is damaged.
- Poor reception.
- Noise.

KNOWING YOUR BABY MONITOR

Package Contents

*Actual contents may vary depending on your purchase.



Camera

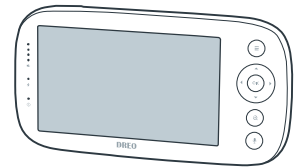

Baby Monitor

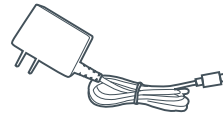

AC Adapter (For Camera)

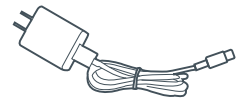

USB Charger and Charging Cable (For Monitor)



Wall Mount Screw



User Manual



Quick Start Guide

PRODUCT DIAGRAM

Camera

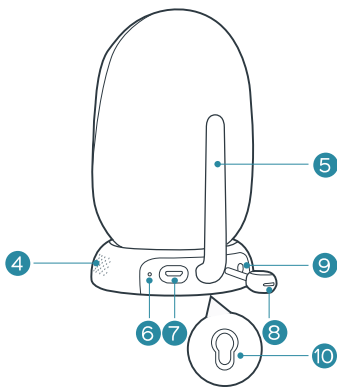
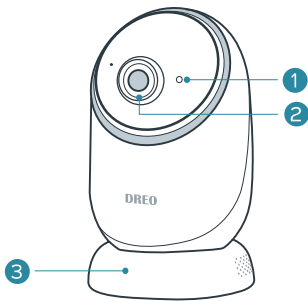

- 1 Light sensor
- 2 Lens
- 3 Camera Base
- 4 Speaker
- 5 Antenna
- 6 Power Indicator
- 7 Micro USB Port
- 8 Temperature Sensor
- 9 Pair Button
- 10 Mounting Hole

Baby Monitor

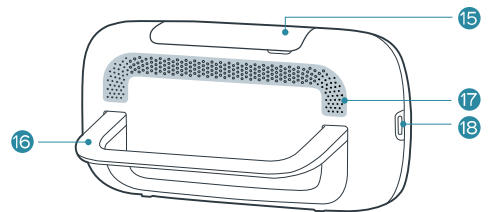
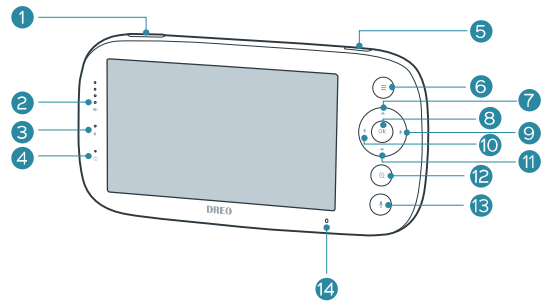

- 1 Volume Button
- 2 Volume Indicators
- 3 Charging Indicator
- 4 Power Indicator
- 5 Power/Sleep Button
- 6 Menu/Back Button
- 7 Up Button
- 8 OK Button
- 9 Right Button
- 10 Left Button
- 11 Down Button
- 12 Zoom Button
- 13 Talk Button
- 14 Microphone
- 15 Antenna
- 16 Back Stand
- 17 Speaker
- 18 USB-C Port

USING YOUR BABY MONITOR

Getting Started

1. Plugging in the Camera

Connect the camera to the power supply with the included AC adapter.

! Place the camera and power cord out of reach of children. Camera is not battery powered. Keep plugged in when in use.

2. Charging the Monitor

Charge the monitor with the included USB-C charging cable and USB charger.

💡 It takes around 7 hours to fully charge. The charging indicator will turn on while charging and off when fully charged.

3. Pairing the Camera with the Monitor

By default, the camera has been paired with the monitor when manufactured. If the camera is disconnected, please refer to page 12.

! Keep camera and monitor within a distance of 12-40 inches (30-100cm) when pairing. Note that microphone feedback might occur when they are close to each other.

4. Positioning the Camera

Keep the camera away from your baby for safety reason, at least 3 feet / 1 meter away.

5. Wall Mounting the Camera (Optional)

Select an ideal spot to mount the camera, keeping it beyond the reach of children. Install the screw into the wall and mount the camera onto the screw.

! Do not release the camera until you're sure it is firmly mounted.

FUNCTIONS & OPERATIONS



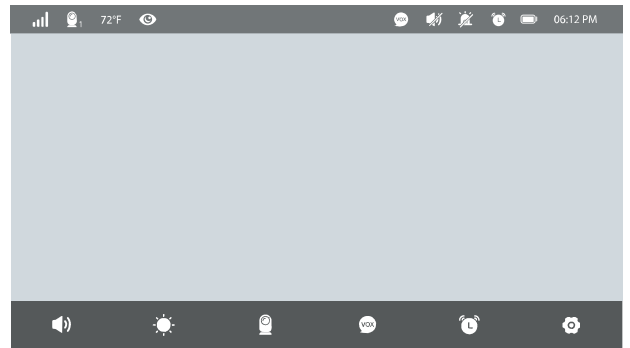



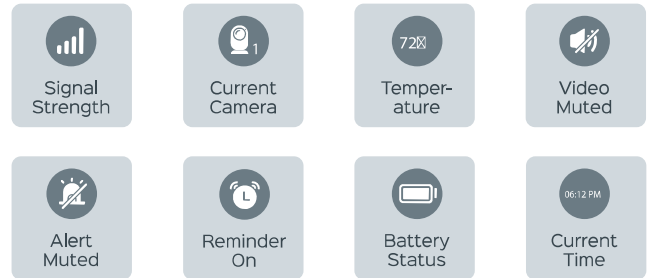

















1. Interface Overview



Status Bar



Menu Bar

 Volume Settings	 Video Volume	Adjust video volume
	 Alert Volume	Adjust alert/reminder volume
 Brightness Settings	 Brightness	Adjust brightness level
	 Screen Timeout	Change screen timeout to 1 min, 3 mins, 5 mins, or never
 Camera Settings	 Add	Add new camera
	 Auto Switch	Auto switch between cameras
	 Cam View	View cameras in full/split screen
	 Delete	Delete camera
 VOX Settings	 VOX On	Turn on VOX
	 VOX Off	Turn off VOX
 Reminder Settings	 Reminder	Set reminder at a specific time
	 Repeat	Create a repeating reminder (2 hrs, 4 hrs, 6 hrs, or never)
	 Reminder Off	Turn off reminder
 Other Settings	 Time	Set the date and time on the monitor
	 Temperature	Select temperature scale between °C and °F
	 Refresh Rate	Select refresh rate between 60Hz and 50Hz
	 Reset	Reset the monitor to factory settings
	 Support	View support page for customer service

2. Volume Settings

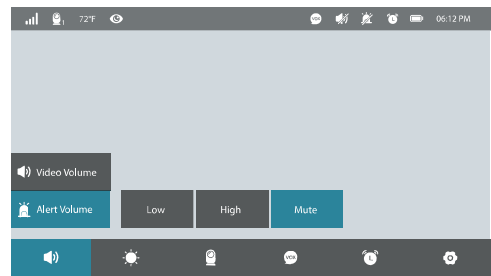
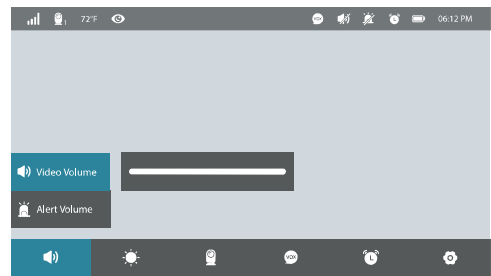
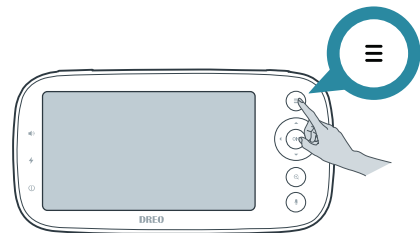

Press , select through  →  Video Volume /  Alert Volume, and press  /  →  to set the desired volume level.



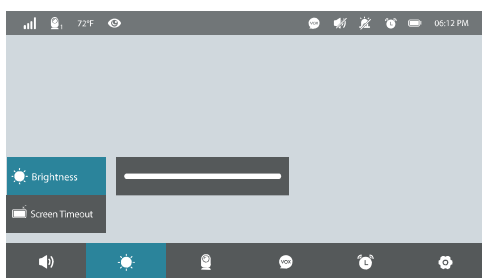



3. Brightness Settings

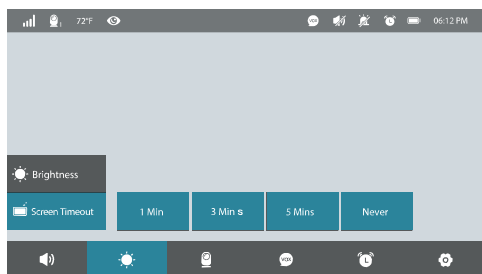

Press , select through  → , and press  /  →  to set the desired brightness level.





4. Screen Timeout

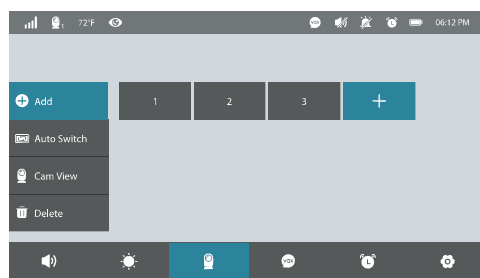

Press , select through  → , and press  /  →  to set the desired time for the screen to turn off automatically.

5. Add Camera



Press , select through  →  → , and press the PAIR button on the camera, then the camera will pair with the monitor automatically.

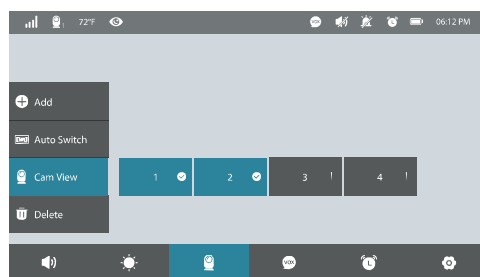

6. View a Camera

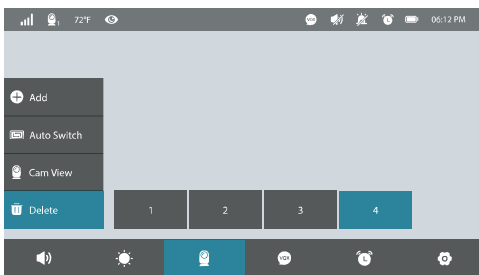

Press , select through  → , and select the camera number 1/2/3/4 to view.

7. Delete a Camera



Press , select through  → ,

and select the camera number 1/2/3/4 to view.



- At least one camera should stay connected.
- The current camera number will appear at the top of the screen.

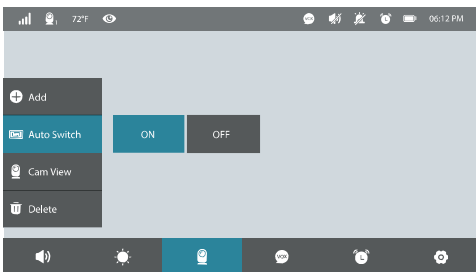

8. Auto Switch



1) Press , select through  →  → .



2) Once set, the screen will automatically switch from one camera to another camera (if connected) every 15 seconds.

9. Split Screen

- 1) Press , select through  → , select two cameras.
- 2) Once two cameras are selected, you can view two cameras in split-screen mode.
- 3) In split-screen mode, the audio will switch between cameras every 15 seconds.

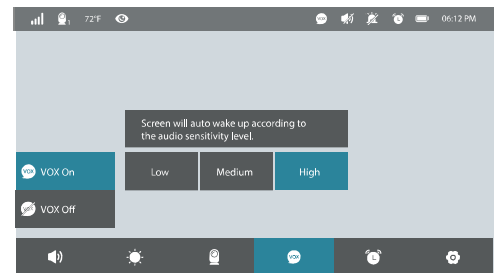



10. VOX (Voice Activated Alert)

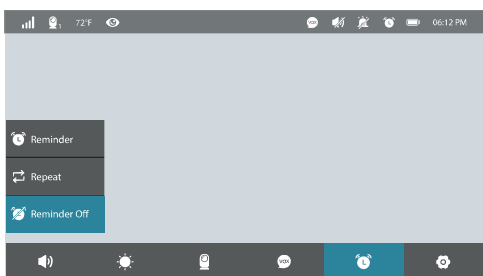

- 1) Press , select through  → .
- 2) Choose a sensitivity level. The higher the VOX sensitivity level, the more sensitive the camera is in detecting sounds for transmitting to the monitor.
- 3) Once set, the screen will go into sleep and enter VOX mode.
- 4) In VOX mode, the screen will stop broadcasting sounds from the camera side until the audio detected is above the alert level.

11. Nursing Reminder







Press , select through  →  **Reminder**, and set a specific time for the monitor to alert you for nursing. You can also select through  →  **Repeat**, and select 2 Hours, 4 Hours, or 6 Hours to create a repeating reminder.



The reminder will sound for 30 seconds and again after 1 minute if no action is taken, but will shut off automatically if none is taken after three times.

12. Talkback





- 1) Push  to talk and release to listen.
- 2) In split screen mode: the talkback function is activated on the left camera by default. You can press  /  →  to select one camera to talk to.

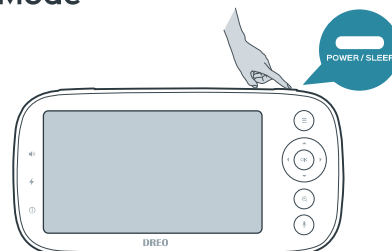

- When the video volume is set low, you might not be able to hear from the camera side.
- When  is pressed, the sound from the camera side will not be heard.

13. Sleep Mode



- 1) Short press  to enter sleep mode. Press any button to wake up.
- 2) In sleep mode, the screen will turn off, but the monitor will continue to receive sounds from the camera.

14. Zoom In & Zoom Out

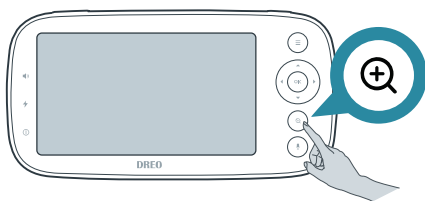

When viewing a camera, press  to magnify the screen at 2x or 4x.

15. Pan & Tilt

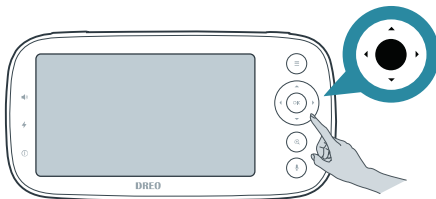

When viewing a camera, press     to view from different angles, 90 degrees vertically and 300 degrees horizontally.

16. Night Vision

The night vision is automatically activated in a dim environment. Infrared LEDs attached on the front of the camera allow you to see the baby in a dark room.



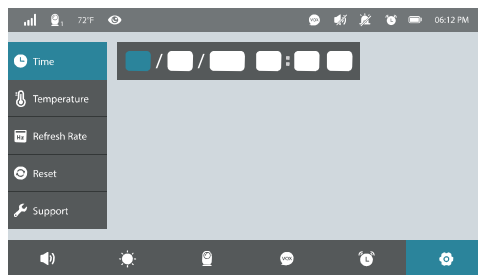

17. Temperature Alert

The monitor will prompt high temperature and low temperature alerts when the ambient temperature is below 50°F / 10°C or above 86°F / 30°C.

18. Other Settings



Press , and select  to enter other settings.

- 1)  Time : Set the date and time on the monitor.
- 2)  Temperature : Select temperature scale between °C and °F.
- 3)  Refresh Rate : Select refresh rate between 60Hz and 50Hz.
- 4)  Reset : Reset the monitor to factory settings.
- 5)  Support : View support page for customer service.

TROUBLESHOOTING



Why won't my baby monitor turn on?

- Make sure the monitor is turned on and there is still power left.
- Charge with the included power cable only.
- Check if the charging indicator is on. If not, please switch to another power outlet or change the adapter.





Is a WiFi connection required to set up and use?

This non-WiFi appliance does not need internet connection for setup. The baby monitor and camera use 2.4GHz radio frequency for transmission.

Why won't my baby monitor connect to the camera?

- Make sure the camera is securely plugged in. Check if the plug and power cord are damaged.
- Make sure the monitor is close to the camera when pairing.
- Check if there are large metallic objects like doors, refrigerators, mirrors that might block signal transmission.
- Check if there are existing 2.4GHz equipment like WiFi networks and microwave ovens that might interfere with signal transmission.
- Press the Menu Button, select through  →  → , and press the PAIR button on the camera, then the camera will pair with the monitor automatically.





Why does the monitor screen keep switching off when I'm using it?

- Press the Menu Button, select through  → , and press  /  →  to set the desired time for the screen to turn off automatically.
- You may have the VOX (Voice Activated Alert) mode on so that the screen will only come on when the sound is above the alert level. You can switch this feature off within the menu.

Why is the screen black when I view a camera?

- Make sure the camera is in range and securely plugged in.
- Check if the plug and power cord are damaged.
- Adjust the monitor antenna to improve the signal strength.

Why is there no sound from the monitor?

- Check if the video volume is too low. Press the Menu Button, select through  → , and press  →  to set the desired volume level.
- Check if VOX mode is turned on. Note that in VOX mode the screen will stop broadcasting sounds from the camera side until the audio detected is above the alert level.

Why is the temperature shown on the monitor not accurate?

- The temperature sensor is on the camera. Please make sure there is enough air circulation around the sensor.
- Do not place the camera near heat sources, including heaters, air-conditioning vents, and lamps.
- The air at the ceiling is warmer than the air at the floor. Place the camera at a relatively low height to read the temperature more accurately.
- Power the monitor and camera off and on again, reset the monitor to factory settings, and pair the camera with the monitor again.





Why did the monitor video suddenly turn black and white?

Night vision may have become activated. Turn on the room lights and night vision will turn off automatically.

Why is the screen a bit choppy?

- Make sure the camera is in range.
- Adjust the monitor antenna to improve the signal strength.

My baby monitor makes a noise.

- Microphone feedback might occur when the monitor is too close to the camera. Keep them away from each other.
- Volume is too high. Press the Menu Button, select through  →  Video Volume, and press  →  to lower the volume.
- The camera is not in range. Please keep the distance within 30 feet / 10 meters.

DREO CUSTOMER CARE

Default 12-Month Warranty

This appliance is covered by Dreo warranty for 12 months from the date of its original purchase.

Extend Your Warranty

Extend your warranty by registering your new appliance on our website <https://dreo.com/warranty>.

The warranty will not apply in cases of:

- Accident, misuse, or repairs performed by unauthorized personnel.
- Any unit that has been tampered with or used for commercial purposes.
- Normal wear and tear of wearable parts.
- Use of force, damage caused by external influences.
- Damage caused by non-observance of the User Manual, e.g. connection to an unsuitable mains supply or noncompliance with the instructions.
- Partially or completely dismantled appliances.
- Defects caused by or resulting from damages from shipping or from repairs, service, or alteration to the product or any of its parts that have been performed by a repair person not authorized by Dreo.

We can only provide after-sales service for products that are sold by Dreo or Dreo authorized retailers and distributors. If you have purchased the appliance from a different place, please contact your seller for return and warranty issues.

We're Here to Help!

 (888) 520-3736
Mon - Fri, 9:00 am-5:00 pm PST/PDT

 www.dreo.com

 support@dreo.com

 www.dreo.com

 Shenzhen Hesung Innovation Technology Co., LTD

 26F, Bldg A7, Creative City, Shenzhen, China

MADE IN CHINA
Rev_1.0_EN

Baby Monitor | 22

尺寸：105*150mm

材质：封面封底200克铜版纸，
内页80克书纸

印刷：双面四色印刷，线条清晰

装订：骑马钉