

TEST REPORT

Report No.: BCTC2208519528-4E

Applicant: ROCKPI TRADING LIMITED

Product Name: Radxa ROCK 3 Model C

Model/Type reference: ROCK 3C D1

Tested Date: 2022-08-08 to 2022-08-15

Issued Date: 2022-08-16



Shenzhen **BCTC Testing Co., Ltd.**



FCC ID:2A3PA-ROCK3C

Product Name: Radxa ROCK 3 Model C
Trademark: N/A
Model/Type reference: ROCK 3C D1
ROCK 3C D2, ROCK 3C D4, ROCK 3C D8
Prepared For: ROCKPI TRADING LIMITED
Address: Room 11, 27 / f, Ga wah international centre, 191 Javaroad, north point, Hong Kong
Manufacturer: ROCKPI TRADING LIMITED
Address: Room 11, 27 / f, Ga wah international centre, 191 Javaroad, north point, Hong Kong
Prepared By: Shenzhen BCTC Testing Co., Ltd.
Address: 1-2/F., Building B, Pengzhou Industrial Park, No.158, Fuyuan 1st Road,
Zhancheng, Fuhai Subdistrict, Bao'an District, Shenzhen, Guangdong, China
Sample Received Date: 2022-08-08
Sample tested Date: 2022-08-08 to 2022-08-15
Issue Date: 2022-08-16
Report No.: BCTC2208519528-4E
Test Standards: FCC Part15 15.407
ANSI C63.10-2013
KDB 789033 D02 v02r01
Test Results: PASS
Remark: This is WIFI-5GHz band radio test report.

Tested by:

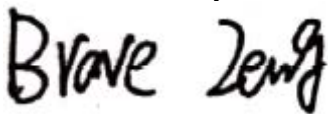

Brave Zeng/ Project Handler

Approved by:



Zero Zhou/Reviewer

The test report is effective only with both signature and specialized stamp. This result(s) shown in this report refer only to the sample(s) tested. Without written approval of Shenzhen BCTC Testing Co., Ltd, this report can't be reproduced except in full. The tested sample(s) and the sample information are provided by the client.

Table Of Content

	Page
Test Report Declaration	
1. Version	5
2. Test Summary	6
3. Measurement Uncertainty	7
4. Product Information And Test Setup	8
4.1 Product Information	8
4.2 Test Setup Configuration	9
4.3 Support Equipment	9
4.4 Channel List	9
4.5 Test Mode	10
4.6 Table Of Parameters Of Text Software Setting	10
5. Test Facility And Test Instrument Used	11
5.1 Test Facility	11
5.2 Test Instrument Used	11
6. Conducted Emissions	13
6.1 Block Diagram Of Test Setup	13
6.2 Limit	13
6.3 Test procedure	13
6.4 EUT operating Conditions	13
6.5 Test Result	14
7. Radiated Emissions	16
7.1 Block Diagram Of Test Setup	16
7.2 Limit	17
7.3 Test procedure	18
7.4 EUT operating Conditions	19
7.5 Test Result	19
8. Power Spectral Density Test	28
8.1 Block Diagram Of Test Setup	28
8.2 Limit	28
8.3 Test procedure	29
8.4 EUT operating Conditions	29
8.5 Test Result	30
9. 26dB & 99% Emission Bandwidth	38
9.1 Block Diagram Of Test Setup	38
9.2 Limit	38
9.3 Test procedure	38
9.4 EUT operating Conditions	39
9.5 Test Result	39
10. Maximum Conducted Output Power	54
10.1 Block Diagram Of Test Setup	54
10.2 Limit	54
10.3 Test procedure	54
10.4 EUT operating Conditions	55
10.5 Test Result	56
11. Out Of Band Emissions	64
11.1 Block Diagram Of Test Setup	64

11.2	Limit	64
11.3	Test procedure	64
11.4	EUT operating Conditions	64
11.5	Test Result	65
12.	Spurious RF Conducted Emissions	71
12.1	Block Diagram Of Test Setup	71
12.2	Limit	71
12.3	Test procedure	71
12.4	Test Result	71
13.	Frequency Stability Measurement	79
13.1	Block Diagram Of Test Setup	79
13.2	Limit	79
13.3	Test procedure	79
13.4	Test Result	80
14.	Antenna Requirement	83
14.1	Limit	83
14.2	Test Antenna	83
15.	EUT Photographs	84
16.	EUT Test Setup Photographs	85

(Note: N/A Means Not Applicable)

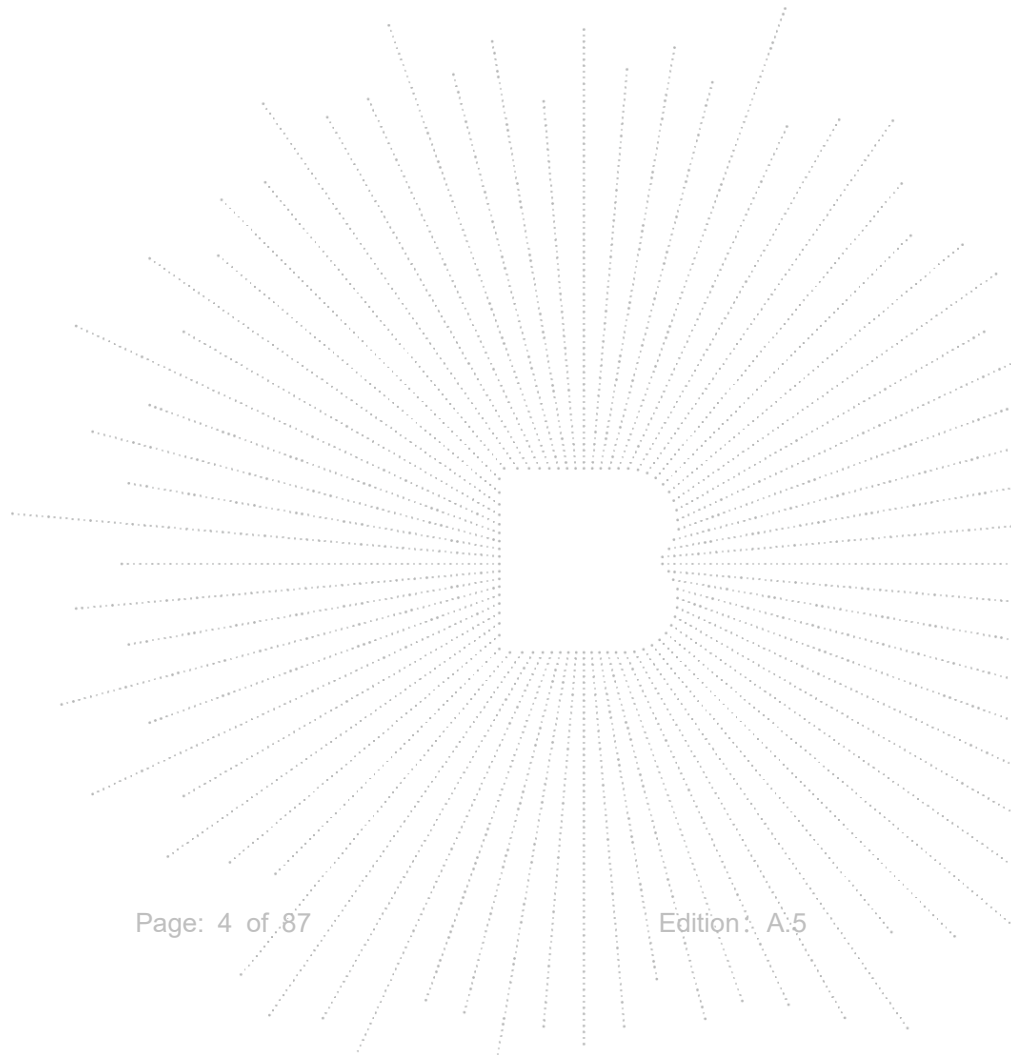

1. Version

Report No.	Issue Date	Description	Approved
BCTC2208519528-4E	2022-08-16	Original	Valid

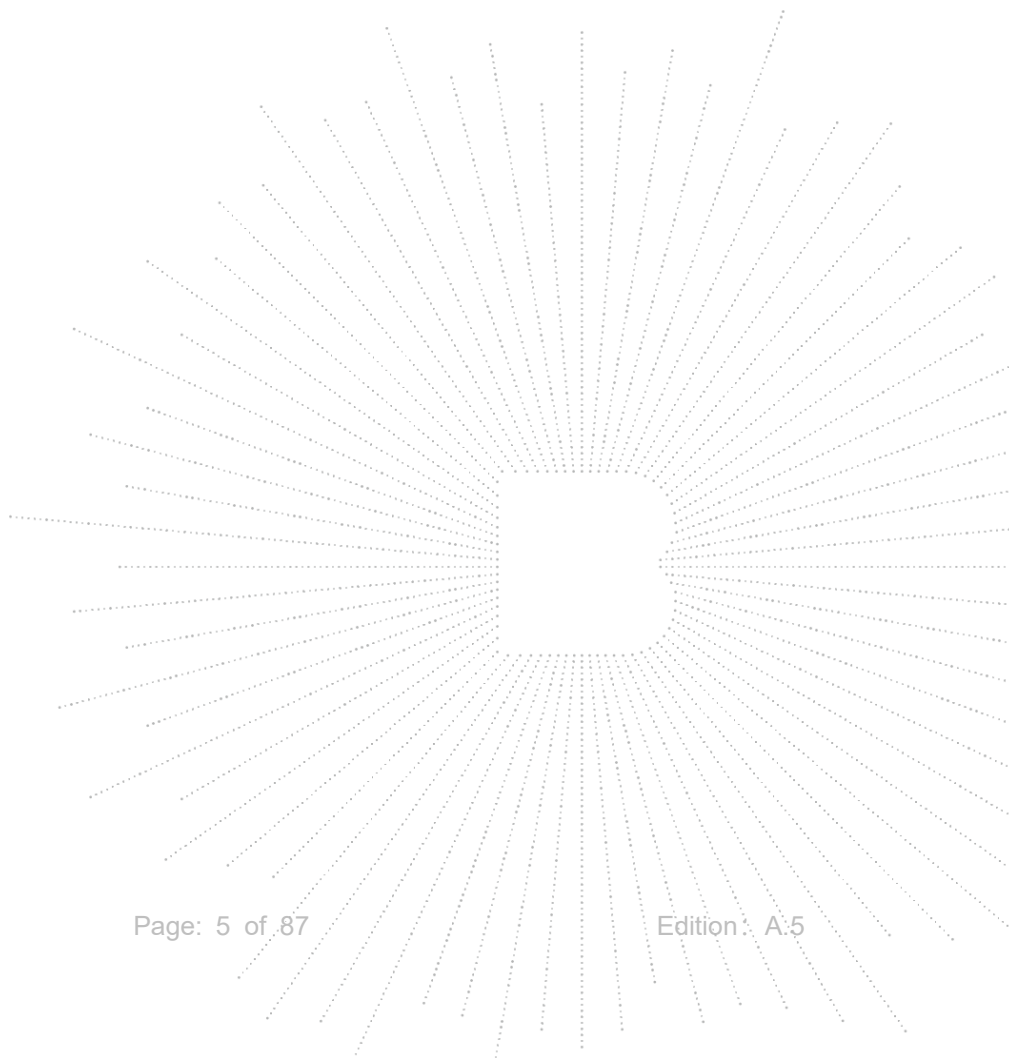

2. Test Summary

The Product has been tested according to the following specifications:

1	Test Parameter	Clause No.	Results
1	Spurious Radiated Emissions	15.209(a), 15.407 (b)(1) 15.407 (b)(4) 15.407 (b)(8)	PASS
2	Conducted Emission	15.207	PASS
3	26 dB and 99% Emission Bandwidth	15.407 (a)(12) 15.1049	PASS
4	Minimum 6 dB bandwidth	15.407(e)	N/A
5	Maximum Conducted Output Power	15.407 (a)(1) 15.407 (a)(3)	PASS
6	Band Edge	2.1051, 15.407(b)(1) 15.407(b)(4)	PASS
7	Power Spectral Density	15.407 (a)(1) 15.407 (a)(3)	PASS
8	Spurious Emissions at Antenna Terminals	2.1051, 15.407(b)	PASS
9	Antenna Requirement	15.203	PASS

3. Measurement Uncertainty

Where relevant, the following measurement uncertainty levels have been estimated for tests performed on the Product as specified in CISPR 16-4-2. This uncertainty represents an expanded uncertainty expressed at approximately the 95% confidence level using a coverage factor of k=2.

No.	Item	Uncertainty
1	3m chamber Radiated spurious emission(30MHz-1GHz)	U=4.3dB
2	3m chamber Radiated spurious emission(9KHz-30MHz)	U=3.7dB
3	3m chamber Radiated spurious emission(1GHz-18GHz)	U=4.5dB
4	3m chamber Radiated spurious emission(18GHz-40GHz)	U=3.34dB
5	Conducted Emission (150kHz-30MHz)	U=3.20dB
6	Conducted Adjacent channel power	U=1.38dB
7	Conducted output power uncertainty Above 1G	U=1.576dB
8	Conducted output power uncertainty below 1G	U=1.28dB
9	humidity uncertainty	U=5.3%
10	Temperature uncertainty	U=0.59°C

4. Product Information And Test Setup

4.1 Product Information

Model/Type reference:	ROCK 3C D1 ROCK 3C D2, ROCK 3C D4, ROCK 3C D8
Model differences:	All the model are the same circuit and RF module, except model names.
Hardware Version:	N/A
Software Version:	N/A
IEEE 802.11 WLAN Mode Supported:	802.11a/n/ac(20MHz channel bandwidth) 802.11n/ac(40MHz channel bandwidth) 802.11ac(80MHz channel bandwidth)
Operation Frequency:	5180-5240MHz for 802.11a/n(HT20)/ac20; 5190-5230MHz for 802.11n(HT40)/ac40; 5210MHz for 802.11 ac80
Data Rate	802.11a: 6,9,12,18,24,36,48,54Mbps; 802.11n(HT20/HT40):MCS0-MCS15; 802.11ac(VHT20): NSS1, MCS0-MCS8 802.11ac(VHT40/VHT80):NSS1, MCS0-MCS
Type of Modulation:	OFDM with BPSK/QPSK/16QAM/64QAM/256QAM for 802.11a/n/ac;
Number Of Channel	4 channels for 802.11a/n20 in the 5180-5240MHz band ; 2 channels for 802.11 n40 in the 5190-5230MHz band ; 1 channels for 802.11 ac80 in the 5210MHz band
Antenna installation:	Chip antenna
Antenna Gain:	2 dBi
Ratings:	DC 5V From adapter

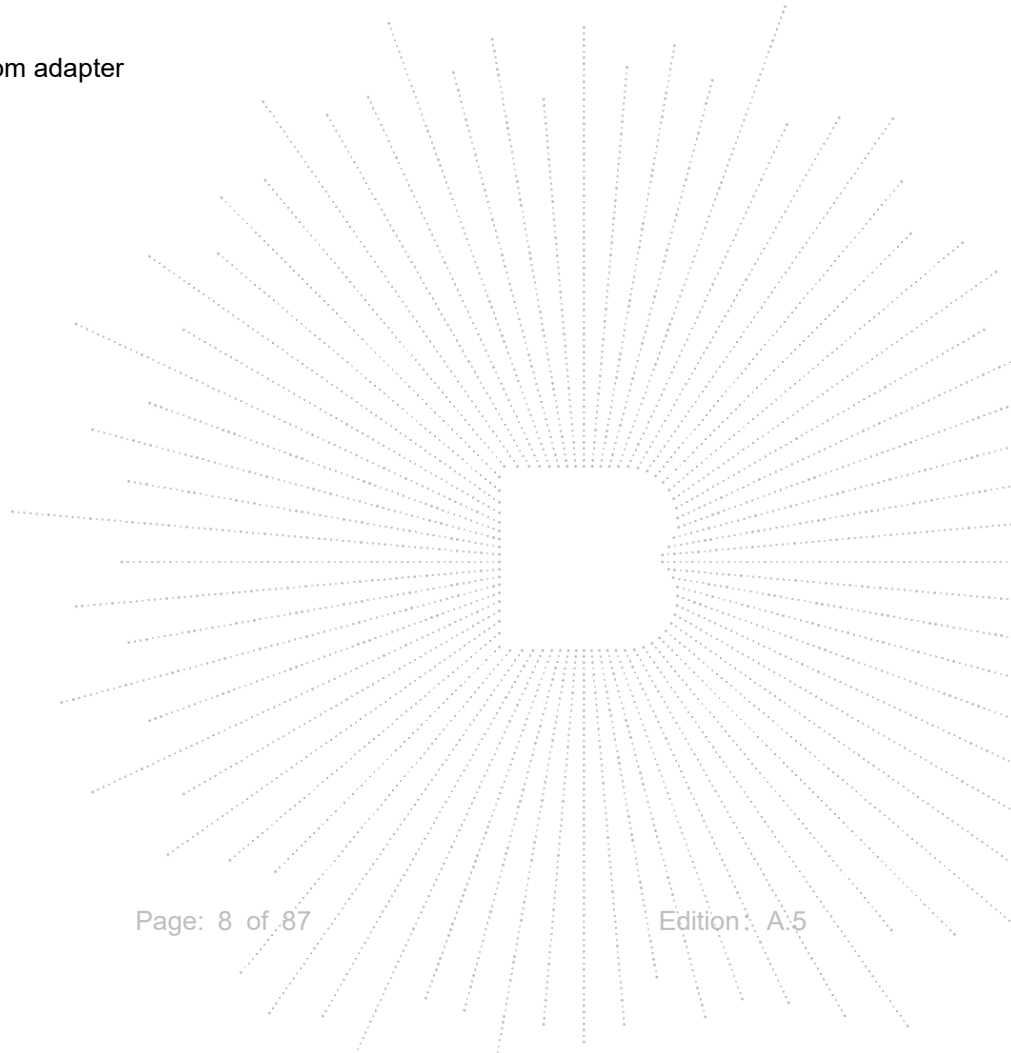

4.2 Test Setup Configuration

See test photographs attached in *EUT TEST SETUP PHOTOGRAPHS* for the actual connections between Product and support equipment.

Conducted Emission:

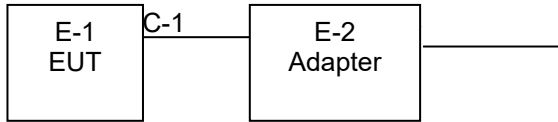

Radiated Spurious Emission

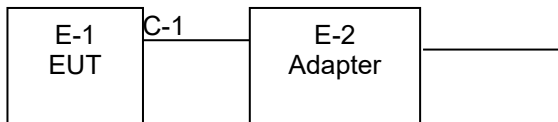

4.3 Support Equipment

No.	Device Type	Brand	Model	Series No.	Note
E-1	Radxa ROCK 3 Model C	N/A	ROCK 3C D1	Ref. the Section 4.1	EUT
E-2	Adapter	N/A	BCTC001	N/A	Auxiliary

Item	Shielded Type	Ferrite Core	Length	Note
C-1	N/A	N/A	0.3M	DC cable unshielded

Notes:

- All the equipment/cables were placed in the worst-case configuration to maximize the emission during the test.
- Grounding was established in accordance with the manufacturer's requirements and conditions for the intended use.

4.4 Channel List

Frequency and Channel list for 802.11a/n/ac (5180-5240MHz):

802.11a/n/ac(20MHz) Carrier Frequency Channel							
Channel	Frequency (MHz)	Channel	Frequency (MHz)	Channel	Frequency (MHz)	Channel	Frequency (MHz)
36	5180	44	5220	40	5200	48	5240

802.11n/ac(40MHz) Carrier Frequency Channel							
Channel	Frequency (MHz)	Channel	Frequency (MHz)	Channel	Frequency (MHz)	Channel	Frequency (MHz)
38	5190	46	5230	-	-	-	-

802.11ac (80MHz) Carrier Frequency Channel							
Channel	Frequency (MHz)	Channel	Frequency (MHz)	Channel	Frequency (MHz)	Channel	Frequency (MHz)
42	5210	-	-	-	-	-	-

4.5 Test Mode

To investigate the maximum EMI emission characteristics generates from EUT, the test system was pre-scanning tested base on the consideration of following EUT operation mode or test configuration mode which possible have effect on EMI emission level. Each of these EUT operation mode(s) or test configuration mode(s) mentioned above was evaluated respectively.

Pretest Mode	Description
Mode 1	802.11a / n/ ac 20 CH36/ CH40/ CH 48
Mode 2	802.11n/ ac40 CH38/ CH 46
Mode 3	802.11 ac80 CH 42
Mode 4	Link Mode

Conducted Emission	
Final Test Mode	Description
Mode 4	Link Mode

For Radiated Emission	
Final Test Mode	Description
Mode 1	802.11a / n/ ac 20 CH36/ CH40/ CH 48
Mode 2	802.11n/ ac40 CH38/ CH 46
Mode 3	802.11 ac80 CH 42

Note: The measurements are performed at all Bit Rate of Transmitter, the worst data was reported.

4.6 Table Of Parameters Of Text Software Setting

During testing channel & power controlling software provided by the customer was used to control the operating channel as well as the output power level. The RF output power selection is for the setting of RF output power expected by the customer and is going to be fixed on the firmware of the final end product power parameters

Test software Version	CMD		
Parameters	DEF	DEF	DEF

5. Test Facility And Test Instrument Used

5.1 Test Facility

All measurement facilities used to collect the measurement data are located at Shenzhen BCTC Testing Co., Ltd. Address:1-2/F., Building B, Pengzhou Industrial Park, No.158, Fuyuan 1st Road, Zhancheng, Fuhai Subdistrict, Bao'an District, Shenzhen, Guangdong, China. The site and apparatus are constructed in conformance with the requirements of ANSI C63.4 and CISPR 16-1-1 other equivalent standards.

FCC Test Firm Registration Number: 712850

IC Registered No.: 23583

5.2 Test Instrument Used

Conducted Emissions Test					
Equipment	Manufacturer	Model#	Serial#	Last Cal.	Next Cal.
Receiver	R&S	ESR3	102075	May 24, 2022	May 23, 2023
LISN	R&S	ENV216	101375	May 24, 2022	May 23, 2023
Software	Frad	EZ-EMC	EMC-CON 3A1	\	\
Attenuator	\	10dB C-6GHz	1650	May 24, 2022	May 23, 2023

RF Conducted Test					
Equipment	Manufacturer	Model#	Serial#	Last Cal.	Next Cal.
Power Metter	Keysight	E4419	\	May 24, 2022	May 23, 2023
Power Sensor (AV)	Keysight	E9300A	\	May 24, 2022	May 23, 2023
Signal Analyzer 20kHz-26.5G Hz	Keysight	N9020A	MY49100060	May 24, 2022	May 23, 2023
Spectrum Analyzer 9kHz-40GHz	R&S	FSP 40	\	May 24, 2022	May 23, 2023

Radiated Emissions Test (966 Chamber)					
Equipment	Manufacturer	Model#	Serial#	Last Cal.	Next Cal.
966 chamber	ChengYu	966 Room	966	Jun. 06. 2020	Jun. 05, 2023
Receiver	R&S	ESR3	102075	May 24, 2022	May 23, 2023
Receiver	R&S	ESRP	101154	May 24, 2022	May 23, 2023
Amplifier	SKET	LAPA_01G18 G-45dB	\	May 24, 2022	May 23, 2023
Amplifier	Schwarzbeck	BBV9744	9744-0037	May 24, 2022	May 23, 2023
TRILOG Broadband Antenna	Schwarzbeck	VULB9163	942	May 26, 2022	May 25, 2023
Horn Antenna	Schwarzbeck	BBHA9120D	1541	Jun. 06, 2022	Jun. 05, 2023
Horn Antenn (18GHz-40GHz)	Schwarzbeck	BBHA9170	00822	Jun. 06, 2022	Jun. 05, 2023
Amplifier (18GHz-40GHz)	MITEQ	TTA1840-35- HG	2034381	May 26, 2022	May 25, 2023
Loop Antenna (9KHz-30MHz)	Schwarzbeck	FMZB1519B	00014	May 26, 2022	May 25, 2023
RF cables1 (9kHz-30MHz)	Huber+Suhnar	9kHz-30MHz	B1702988-000 8	May 26, 2022	May 25, 2023
RF cables2 (30MHz-1GHz)	Huber+Suhnar	30MHz-1GHz	1486150	May 26, 2022	May 25, 2023
RF cables3 (1GHz-40GHz)	Huber+Suhnar	1GHz-40GHz	1607106	May 26, 2022	May 25, 2023
Power Metter	Keysight	E4419	\	May 26, 2022	May 25, 2023
Power Sensor (AV)	Keysight	E9300A	\	May 26, 2022	May 25, 2023
Signal Analyzer 20kHz-26.5GHz	Keysight	N9020A	MY49100060	May 26, 2022	May 25, 2023
Spectrum Analyzer 9kHz-40GHz	R&S	FSP 40	\	May 26, 2022	May 25, 2023
Software	Frad	EZ-EMC	FA-03A2 RE	\	\

6. Conducted Emissions

6.1 Block Diagram Of Test Setup

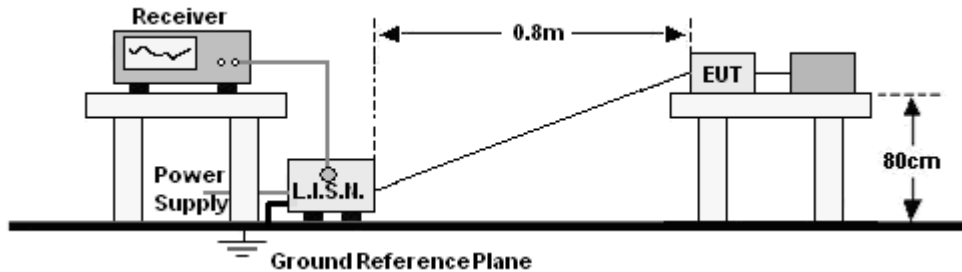

6.2 Limit

Frequency (MHz)	Limit (dBuV)	
	Quas-peak	Average
0.15 -0.5	66 - 56 *	56 - 46 *
0.50 -5.0	56.00	46.00
5.0 -30.0	60.00	50.00

Notes:

- *Decreasing linearly with logarithm of frequency.
- The lower limit shall apply at the transition frequencies.

6.3 Test procedure

Receiver Parameters	Setting
Attenuation	10 dB
Start Frequency	0.15 MHz
Stop Frequency	30 MHz
IF Bandwidth	9 kHz

- The Product was placed on a nonconductive table 0.8 m above the horizontal ground reference plane, and 0.4 m from the vertical ground reference plane, and connected to the main through Line Impedance Stability Network (L.I.S.N).
- The RBW of the receiver was set at 9 kHz in 150 kHz ~ 30MHz with Peak and AVG detector in Max Hold mode. Run the receiver's pre-scan to record the maximum disturbance generated from Product in all power lines in the full band.
- For each frequency whose maximum record was higher or close to limit, measure its QP and AVG values and record.

6.4 EUT operating Conditions

The EUT was configured for testing in a typical fashion (as a customer would normally use it). The EUT has been programmed to continuously transmit during test. This operating condition was tested and used to collect the included data.

We pretest AC 120V and AC 240V, the worst voltage was AC 120V and the data recording in the report.

6.5 Test Result

Temperature:	26 °C	Relative Humidity:	54%
Pressure:	101KPa	Test Voltage :	DC 5V
Test Mode:	Mode 4	Polarization :	L

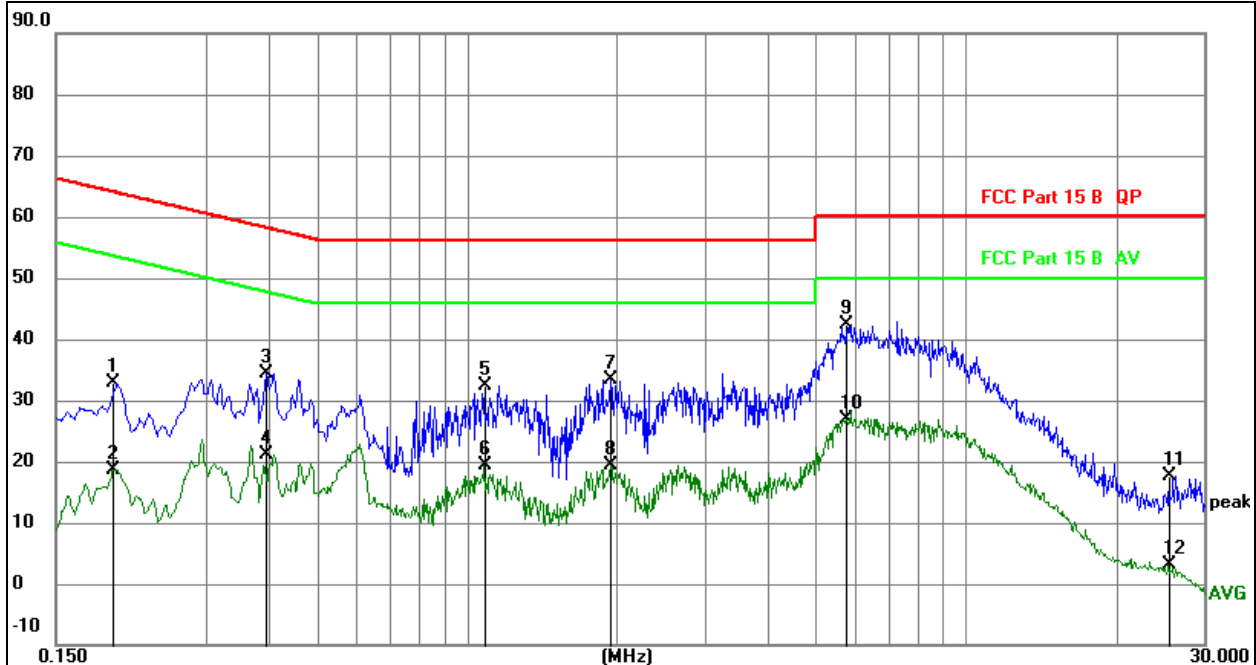

Remark:

1. All readings are Quasi-Peak and Average values.
2. Factor = Insertion Loss + Cable Loss.
3. Measurement = Reading Level + Correct Factor
4. Over = Measurement - Limit

No.	Mk.	Freq. MHz	Reading Level	Correct Factor dB	Measure- ment dBuV	Limit dBuV	Over dB	Detector
1		0.1945	13.15	19.79	32.94	63.84	-30.90	QP
2		0.1945	-1.10	19.79	18.69	53.84	-35.15	AVG
3		0.3955	14.73	19.75	34.48	57.95	-23.47	QP
4		0.3955	1.37	19.75	21.12	47.95	-26.83	AVG
5		1.0824	12.62	19.77	32.39	56.00	-23.61	QP
6		1.0824	-0.31	19.77	19.46	46.00	-26.54	AVG
7		1.9386	13.56	19.87	33.43	56.00	-22.57	QP
8		1.9386	-0.38	19.87	19.49	46.00	-26.51	AVG
9	*	5.7437	22.32	20.15	42.47	60.00	-17.53	QP
10		5.7437	6.83	20.15	26.98	50.00	-23.02	AVG
11		25.4560	-2.81	20.52	17.71	60.00	-42.29	QP
12		25.4560	-17.32	20.52	3.20	50.00	-46.80	AVG

Temperature:	26 °C	Relative Humidity:	54%
Pressure:	101KPa	Test Voltage :	DC 5V
Test Mode:	Mode 4	Polarization :	N

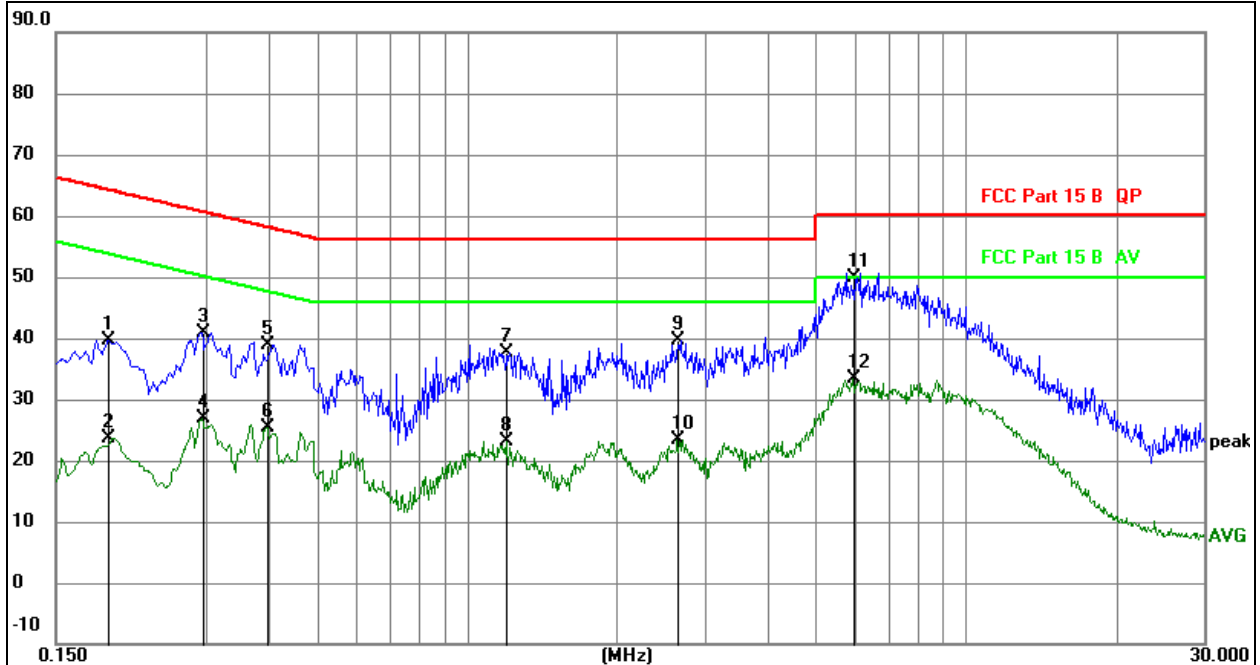
Remark:

1. All readings are Quasi-Peak and Average values.
2. Factor = Insertion Loss + Cable Loss.
3. Measurement = Reading Level + Correct Factor
4. Over = Measurement - Limit

No.	Mk.	Freq. MHz	Reading Level	Correct Factor dB	Measure- ment dBuV	Limit dBuV	Over dB	Detector
1		0.1905	19.93	19.78	39.71	64.01	-24.30	QP
2		0.1905	3.95	19.78	23.73	54.01	-30.28	AVG
3		0.2940	21.17	19.77	40.94	60.41	-19.47	QP
4		0.2940	7.21	19.77	26.98	50.41	-23.43	AVG
5		0.3975	19.14	19.75	38.89	57.91	-19.02	QP
6		0.3975	5.57	19.75	25.32	47.91	-22.59	AVG
7		1.2030	17.86	19.78	37.64	56.00	-18.36	QP
8		1.2030	3.43	19.78	23.21	46.00	-22.79	AVG
9		2.6430	19.66	19.95	39.61	56.00	-16.39	QP
10		2.6430	3.53	19.95	23.48	46.00	-22.52	AVG
11	*	5.9370	29.63	20.15	49.78	60.00	-10.22	QP
12		5.9370	13.33	20.15	33.48	50.00	-16.52	AVG

7. Radiated Emissions

7.1 Block Diagram Of Test Setup

(A) Radiated Emission Test-Up Frequency Below 30MHz

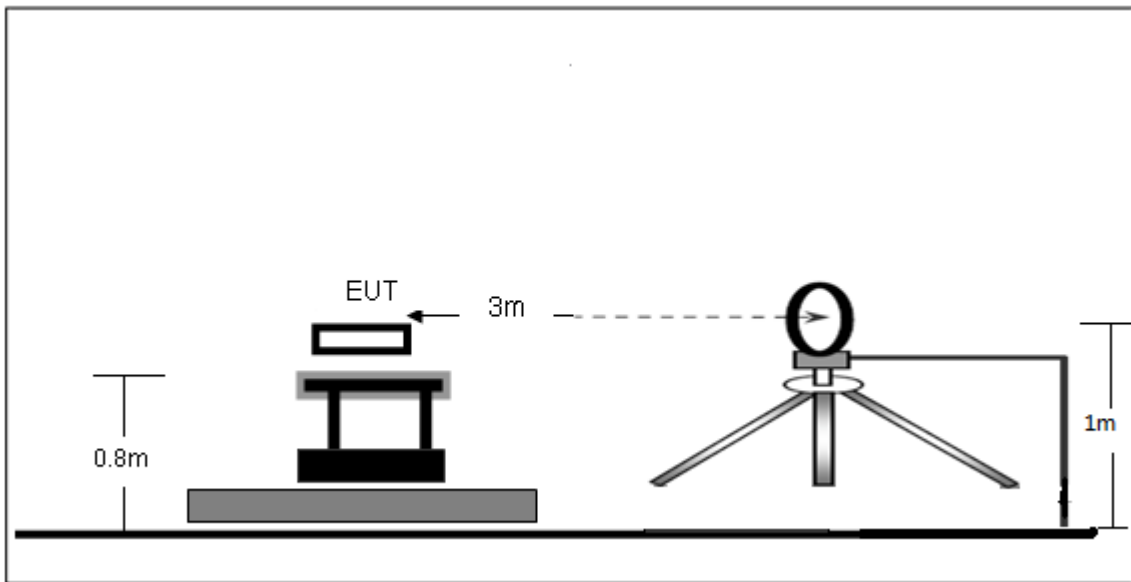

(B) Radiated Emission Test-Up Frequency 30MHz~1GHz

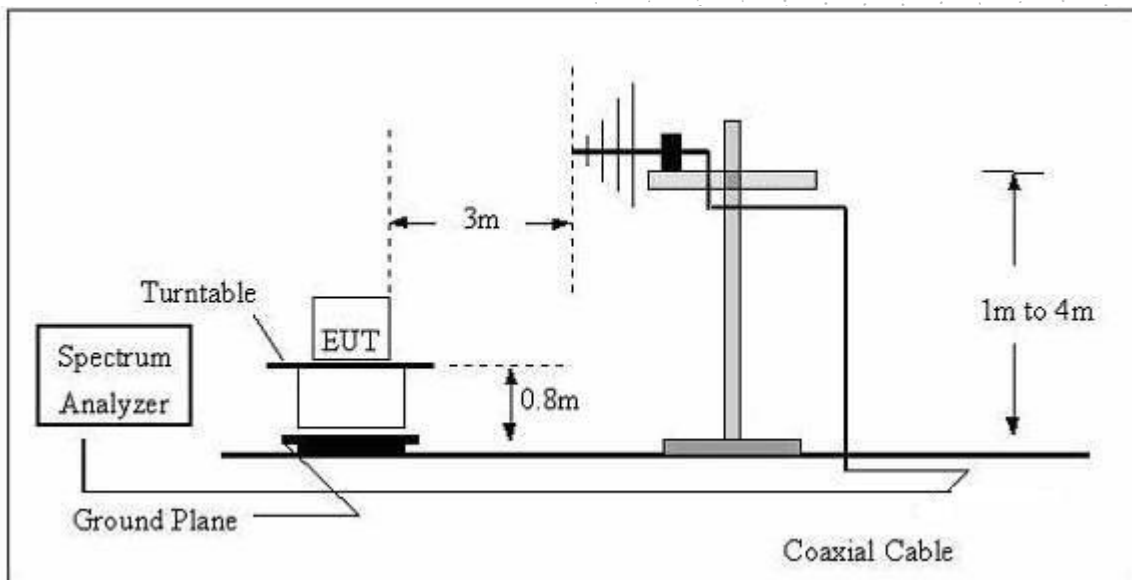

(C) Radiated Emission Test-Up Frequency Above 1GHz



7.2 Limit

20dBc in any 100 kHz bandwidth outside the operating frequency band. In case the emission fall within the restricted band specified on 15.205(a), then the 15.209(a) limit in the table below has to be followed.

Frequency (MHz)	Field Strength uV/m	Distance (m)	Field Strength Limit at 3m Distance	
			uV/m	dBuV/m
0.009 ~ 0.490	2400/F(kHz)	300	$10000 * 2400/F(\text{kHz})$	$20\log^{(2400/F(\text{kHz}))} + 80$
0.490 ~ 1.705	24000/F(kHz)	30	$100 * 24000/F(\text{kHz})$	$20\log^{(24000/F(\text{kHz}))} + 40$
1.705 ~ 30	30	30	$100 * 30$	$20\log^{(30)} + 40$
30 ~ 88	100	3	100	$20\log^{(100)}$
88 ~ 216	150	3	150	$20\log^{(150)}$
216 ~ 960	200	3	200	$20\log^{(200)}$
Above 960	500	3	500	$20\log^{(500)}$

Limits Of Radiated Emission Measurement (Above 1000MHz)

Frequency (MHz)	Limit (dBuV/m) (at 3M)	
	Peak	Average
Above 1000	74	54

Notes:

- (1)The limit for radiated test was performed according to FCC PART 15C.
- (2)The tighter limit applies at the band edges.
- (3) Emission level (dBuV/m)=20log Emission level (uV/m).

7.3 Test procedure

The test site semi-anechoic chamber has met the requirement of NSA tolerance 4 dB according to the standards: ANSI C63.10-2013. The test distance is 3m. The setup is according to the requirements in Section 13.1.4.1 of ANSI C63.10-2013 and CAN/CSA-CEI/IEC CISPR 22.

This test is required for any spurious emission that falls in a Restricted Band, as defined in Section 15.205.

It must be performed with the highest gain of each type of antenna proposed for use with the EUT. Use the following spectrum analyzer settings:

Spectrum Parameter	Setting
Attenuation	Auto
Start Frequency	1000 MHz
Stop Frequency	10th carrier harmonic
RB / VB (emission in restricted band)	1 MHz / 1 MHz for Peak, 1 MHz / 10Hz for Average

Receiver Parameter	Setting
Attenuation	Auto
Start ~ Stop Frequency	9kHz~150kHz / RB 200Hz for QP
Start ~ Stop Frequency	150kHz~30MHz / RB 9kHz for QP
Start ~ Stop Frequency	30MHz~1000MHz / RB 120kHz for QP

- The measuring distance of at 3 m shall be used for measurements at frequency up to 1GHz. For frequencies above 1GHz, any suitable measuring distance may be used.
- The EUT was placed on the top of a rotating table 0.8 m for below 1GHz and 1.5m for above 1GHz the ground at a 3 meter. The table was rotated 360 degrees to determine the position of the highest radiation.
- The height of the equipment or of the substitution antenna shall be 0.8 m for below 1GHz and 1.5m for above 1GHz; the height of the test antenna shall vary between 1 m to 4 m. Both horizontal and vertical polarizations of the antenna are set to make the measurement.
- The initial step in collecting conducted emission data is a spectrum analyzer peak detector mode pre-scanning the measurement frequency range. Significant peaks are then marked and then Quasi Peak detector mode re-measured.
- If the Peak Mode measured value compliance with and lower than Quasi Peak Mode Limit, the EUT shall be deemed to meet QP Limits and then no additional QP Mode measurement performed.
- For the actual test configuration, please refer to the related Item –EUT Test Photos.

Note:

Both horizontal and vertical antenna polarities were tested and performed pretest to three orthogonal axis. The worst case emissions were reported

During the radiated emission test, the Spectrum Analyzer was set with the following configurations:

Frequency Band (MHz)	Function	Resolution bandwidth	Video Bandwidth
30 to 1000	QP	120 kHz	300 kHz
Above 1000	Peak	1 MHz	1 MHz
	Average	1 MHz	10 Hz

Note: for the frequency ranges below 30 MHz, a narrower RBW is used for these ranges but the measured value should add a RBW correction factor (RBWCF) where $RBWCF [dB] = 10 \cdot \lg(100 [kHz] / \text{narrower RBW [kHz]})$. , the narrower RBW is 1 kHz and RBWCF is 20 dB for the frequency 9 kHz to 150 kHz, and the narrower RBW is 10 kHz and RBWCF is 10 dB for the frequency 150 kHz to 30 MHz.

7.4 EUT operating Conditions

The EUT was configured for testing in a typical fashion (as a customer would normally use it). The EUT has been programmed to continuously transmit during test. This operating condition was tested and used to collect the included data.

7.5 Test Result

Below 30MHz

Temperature:	26 °C	Relative Humidity:	54%
Pressure:	101KPa	Test Voltage:	DC 5V
Test Mode:	Mode 4	Polarization:	---

Freq.	Reading	Limit	Margin	State
(MHz)	(dBuV/m)	(dBuV/m)	(dB)	P/F
--	--	--	--	PASS
--	--	--	--	PASS

Note:

The amplitude of spurious emissions which are attenuated by more than 20dB below the permissible value has no need to be reported.

Distance extrapolation factor = $40 \log(\text{specific distance/test distance})(\text{dB})$;

Limit line = specific limits(dBuv) + distance extrapolation factor.

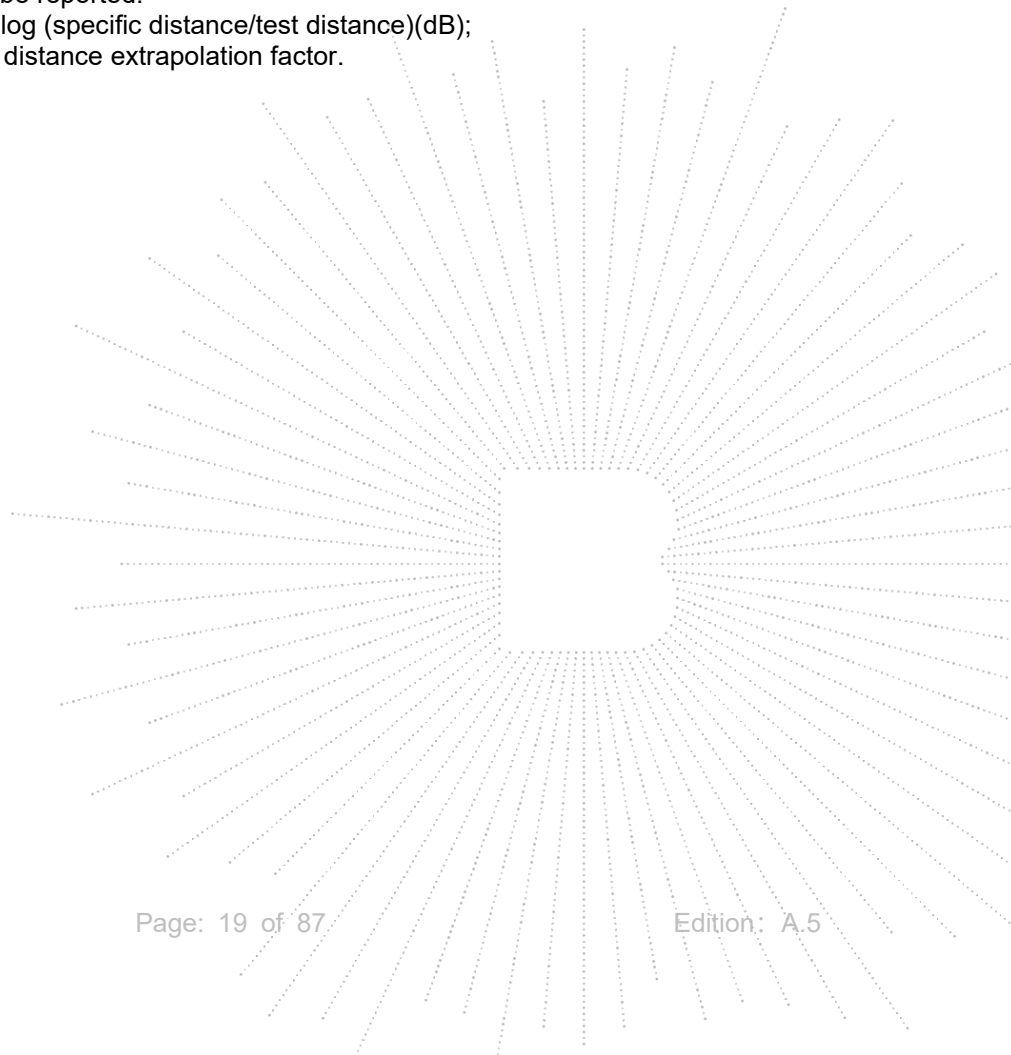

Temperature:	26 °C	Relative Humidity:	54%
Pressure:	101KPa	Test Voltage:	DC 5V
Test Mode:	Mode 4	Polarization:	Horizontal

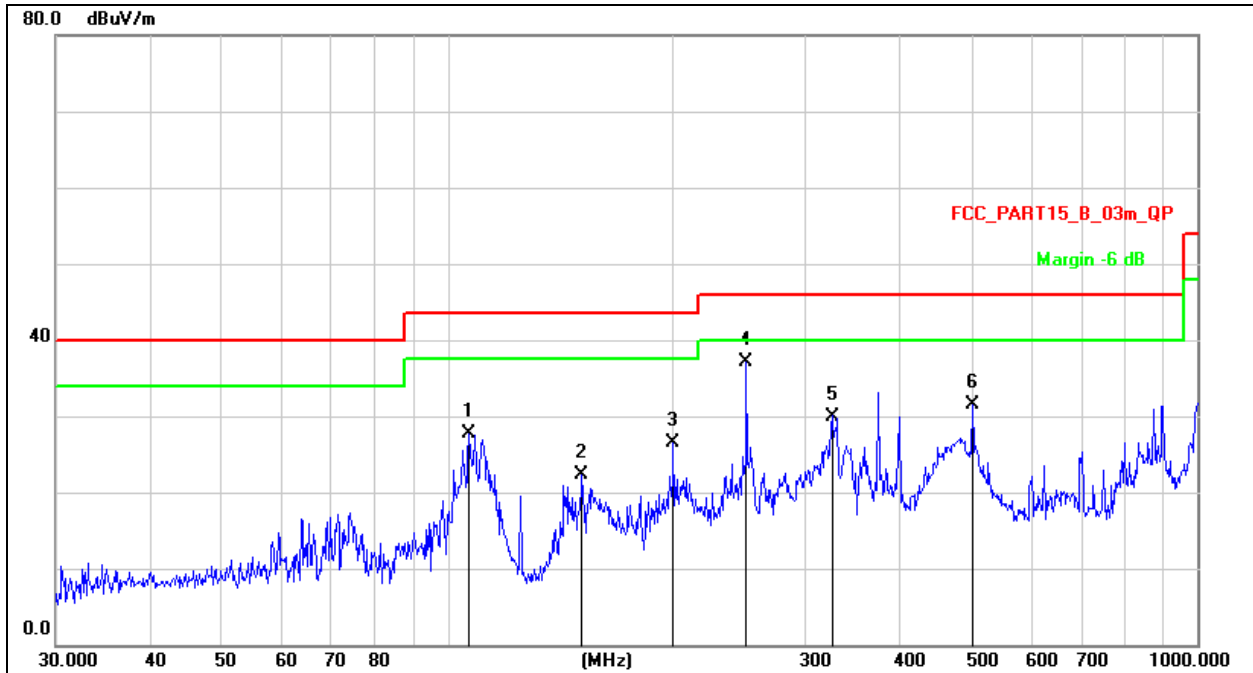
Remark:

1. Factor = Antenna Factor + Cable Loss – Pre-amplifier.
2. Measurement = Reading Level + Correct Factor
3. Over = Measurement - Limit

No.	Mk.	Freq.	Reading Level	Correct Factor	Measurement	Limit	Over	Detector
		MHz	dBuV	dB	dBuV/m	dB/m	dB	
1		106.7587	46.43	-18.67	27.76	43.50	-15.74	QP
2		151.0666	43.88	-21.62	22.26	43.50	-21.24	QP
3		199.9856	44.67	-18.10	26.57	43.50	-16.93	QP
4	*	250.3012	53.51	-16.43	37.08	46.00	-8.92	QP
5		325.5958	44.57	-14.57	30.00	46.00	-16.00	QP
6		501.1790	42.61	-11.11	31.50	46.00	-14.50	QP

Temperature:	26 °C	Relative Humidity:	54%
Pressure:	101KPa	Test Voltage:	DC 5V
Test Mode:	Mode 4	Polarization:	Vertical

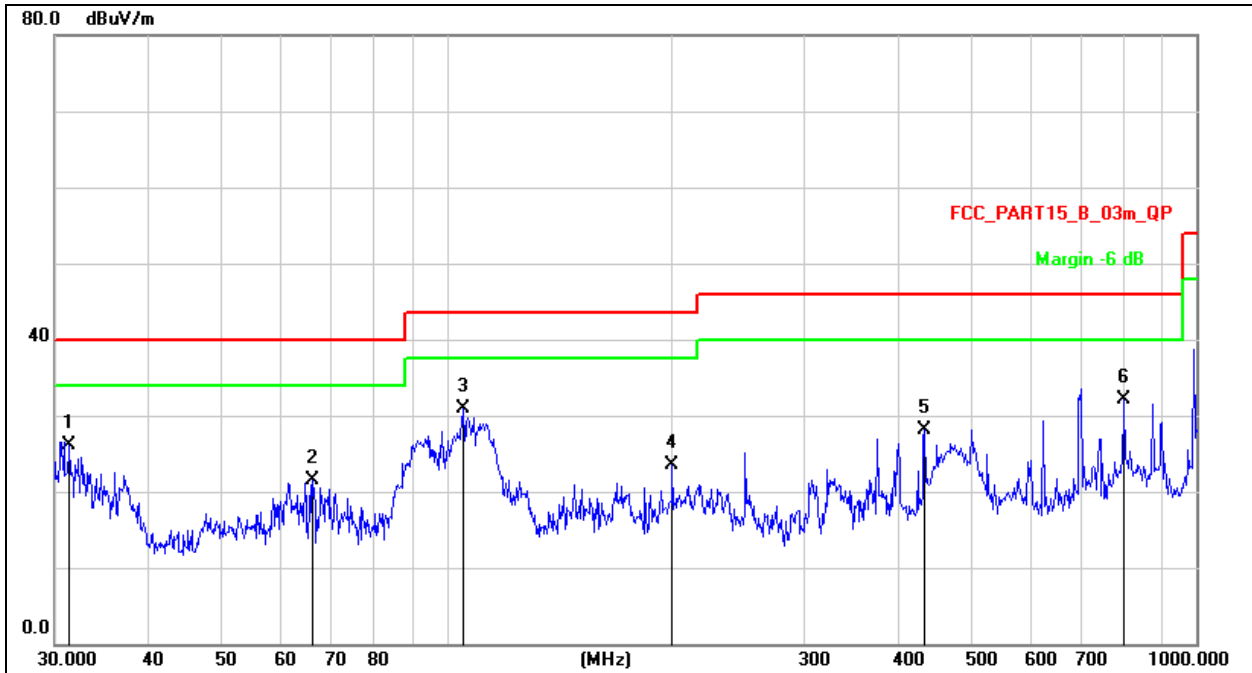

Remark:
 1. Factor = Antenna Factor + Cable Loss – Pre-amplifier.
 2. Measurement = Reading Level + Correct Factor
 3. Over = Measurement - Limit

No.	Mk.	Freq. MHz	Reading Level dBuV	Correct Factor dB	Measure- ment dBuV/m	Limit dB/m	Over dB	Detector
1		31.3992	44.87	-18.86	26.01	40.00	-13.99	QP
2		66.2662	40.76	-19.35	21.41	40.00	-18.59	QP
3	*	105.2718	49.41	-18.57	30.84	43.50	-12.66	QP
4		199.9856	41.55	-18.10	23.45	43.50	-20.05	QP
5		434.0651	40.58	-12.52	28.06	46.00	-17.94	QP
6		801.7863	38.70	-6.54	32.16	46.00	-13.84	QP

Test Mode:	TX(5.1G) - 802.11a
------------	--------------------

Polar (H/V)	Frequency	Meter Reading	Cable loss	Antenna Factor	Preamp Factor	Emission Level	Limits	Margin	Detector Type
	(MHz)	(dBuV)	(dB)	dB/m	(dB)	(dBuV/m)	(dBuV/m)	(dB)	
Low Channel (5180 MHz)-Above 1G									
V	4434.037	61.01	5.94	35.40	44.00	58.35	68.2	-9.85	PK
V	4434.037	43.09	5.94	35.40	44.00	40.43	54	-13.57	AV
V	10360.164	60.87	8.46	39.75	44.50	64.58	68.2	-3.62	PK
V	10360.164	43.59	8.46	39.75	44.50	47.30	54	-6.70	AV
V	15540.075	64.94	10.12	38.80	44.10	69.76	74	-4.24	PK
V	15540.075	43.95	10.12	38.80	42.70	50.17	54	-3.83	AV
H	4434.090	65.00	5.94	35.18	44.00	62.12	68.2	-6.08	PK
H	4434.090	43.27	5.94	35.18	44.00	40.39	54	-13.61	AV
H	10360.128	52.00	8.46	38.71	44.50	54.67	68.2	-13.53	PK
H	10360.128	42.01	8.46	38.71	44.50	44.68	54	-9.32	AV
H	15540.063	53.74	10.12	38.38	44.10	58.14	74	-15.86	PK
H	15540.063	41.14	10.12	38.38	44.10	45.54	54	-8.46	AV
Middle Channel (5200 MHz)-Above 1G									
V	4592.006	63.91	6.48	36.35	44.05	62.69	74	-11.31	PK
V	4592.006	43.89	6.48	36.35	44.05	42.67	54	-11.33	AV
V	10400.074	63.87	8.47	37.88	44.51	65.71	68.2	-2.49	PK
V	10400.074	43.65	8.47	37.88	44.51	45.49	54	-8.51	AV
V	15600.031	60.51	10.12	38.80	44.10	65.33	74	-8.67	PK
V	15600.031	43.61	10.12	38.80	42.70	49.83	54	-4.17	AV
H	4592.013	64.86	6.48	36.37	44.05	63.66	74	-10.34	PK
H	4592.013	43.81	6.48	36.37	44.05	42.61	54	-11.39	AV
H	10400.062	50.40	8.47	38.64	44.50	53.01	68.2	-15.19	PK
H	10400.062	40.71	8.47	38.64	44.50	43.32	54	-10.68	AV
H	15600.036	53.98	10.12	38.38	44.10	58.38	74	-15.62	PK
H	15600.036	43.83	10.12	38.38	44.10	48.23	54	-5.77	AV
High Channel (5240 MHz)-Above 1G									
V	4739.078	63.06	7.10	37.24	43.50	63.90	74	-10.10	PK
V	4739.078	43.21	7.10	37.24	43.50	44.05	54	-9.95	AV
V	10480.009	63.89	8.46	37.68	44.50	65.53	68.2	-2.67	PK
V	10480.009	43.40	8.46	37.68	44.50	45.04	54	-8.96	AV
V	15720.146	63.43	10.12	38.80	44.10	68.25	74	-5.75	PK
V	15720.146	43.07	10.12	38.80	42.70	49.29	54	-4.71	AV
H	4739.084	63.59	7.10	37.24	43.50	64.43	74	-9.57	PK
H	4739.084	43.29	7.10	37.24	43.50	44.13	54	-9.87	AV
H	10480.115	51.93	8.46	38.57	44.50	54.46	68.2	-13.74	PK
H	10480.115	43.01	8.46	38.57	44.50	45.54	54	-8.46	AV
H	15720.124	54.24	10.12	38.38	44.10	58.64	74	-15.36	PK
H	15720.124	43.75	10.12	38.38	44.10	48.15	54	-5.85	AV

Note: PK value is lower than the Average value limit, So average didn't record.

The 26.5-40G amplitude of spurious emissions that are attenuated by more than 20dB below the permissible value has no need to be reported.

Emission level (dBuV/m) = 20 log Emission level (uV/m).

Corrected Reading: Antenna Factor + Cable Loss + Read Level - Preamp Factor = Level.

Test Mode:	TX(5.1G) - 802.11n-HT20
------------	-------------------------

Polar (H/V)	Frequency	Meter Reading	Cable loss	Antenna Factor	Preamp Factor	Emission Level	Limits	Margin	Detector Type
	(MHz)	(dBuV)	(dB)	dB/m	(dB)	(dBuV/m)	(dBuV/m)	(dB)	
Low Channel (5180 MHz)-Above 1G									
V	4434.160	64.05	5.94	35.40	44.00	61.39	68.2	-6.81	PK
V	4434.160	43.70	5.94	35.40	44.00	41.04	54	-12.96	AV
V	10360.055	62.35	8.46	39.75	44.50	66.06	68.2	-2.14	PK
V	10360.055	43.23	8.46	39.75	44.50	46.94	54	-7.06	AV
V	15540.113	61.03	10.12	38.80	44.10	65.85	74	-8.15	PK
V	15540.113	43.91	10.12	38.80	42.70	50.13	54	-3.87	AV
H	4434.145	60.66	5.94	35.18	44.00	57.78	68.2	-10.42	PK
H	4434.145	43.29	5.94	35.18	44.00	40.41	54	-13.59	AV
H	10360.162	52.18	8.46	38.71	44.50	54.85	68.2	-13.35	PK
H	10360.162	42.52	8.46	38.71	44.50	45.19	54	-8.81	AV
H	15540.057	53.74	10.12	38.38	44.10	58.14	74	-15.86	PK
H	15540.057	40.70	10.12	38.38	44.10	45.10	54	-8.90	AV
Middle Channel (5200 MHz)-Above 1G									
V	4592.130	61.40	6.48	36.35	44.05	60.18	74	-13.82	PK
V	4592.130	43.39	6.48	36.35	44.05	42.17	54	-11.83	AV
V	10400.168	61.29	8.47	37.88	44.51	63.13	68.2	-5.07	PK
V	10400.168	43.67	8.47	37.88	44.51	45.51	54	-8.49	AV
V	15600.123	60.07	10.12	38.80	44.10	64.89	74	-9.11	PK
V	15600.123	43.02	10.12	38.80	42.70	49.24	54	-4.76	AV
H	4592.112	61.69	6.48	36.37	44.05	60.49	74	-13.51	PK
H	4592.112	43.14	6.48	36.37	44.05	41.94	54	-12.06	AV
H	10400.134	54.32	8.47	38.64	44.50	56.93	68.2	-11.27	PK
H	10400.134	44.10	8.47	38.64	44.50	46.71	54	-7.29	AV
H	15600.149	50.87	10.12	38.38	44.10	55.27	74	-18.73	PK
H	15600.149	40.41	10.12	38.38	44.10	44.81	54	-9.19	AV
High Channel (5240 MHz)-Above 1G									
V	4739.022	61.57	7.10	37.24	43.50	62.41	74	-11.59	PK
V	4739.022	43.36	7.10	37.24	43.50	44.20	54	-9.80	AV
V	10480.104	62.34	8.46	37.68	44.50	63.98	68.2	-4.22	PK
V	10480.104	43.52	8.46	37.68	44.50	45.16	54	-8.84	AV
V	15720.009	61.20	10.12	38.80	44.10	66.02	74	-7.98	PK
V	15720.009	43.41	10.12	38.80	42.70	49.63	54	-4.37	AV
H	4739.062	64.40	7.10	37.24	43.50	65.24	74	-8.76	PK
H	4739.062	43.42	7.10	37.24	43.50	44.26	54	-9.74	AV
H	10480.153	54.73	8.46	38.57	44.50	57.26	68.2	-10.94	PK
H	10480.153	40.74	8.46	38.57	44.50	43.27	54	-10.73	AV
H	15720.009	52.20	10.12	38.38	44.10	56.60	74	-17.40	PK
H	15720.009	41.03	10.12	38.38	44.10	45.43	54	-8.57	AV

Note: PK value is lower than the Average value limit, So average didn't record.
 The 26.5-40G amplitude of spurious emissions that are attenuated by more than 20dB below the permissible value has no need to be reported.
 Emission level (dBuV/m) = 20 log Emission level (uV/m).
 Corrected Reading: Antenna Factor + Cable Loss + Read Level - Preamp Factor = Level.

Test Mode:	TX(5.1G) - 802.11n-HT40
------------	-------------------------

Polar (H/V)	Frequency	Meter Reading	Cable loss	Antenna Factor	Preamp Factor	Emission Level	Limits	Margin	Detector Type
	(MHz)	(dBuV)	(dB)	dB/m	(dB)	(dBuV/m)	(dBuV/m)	(dB)	
Low Channel (5190 MHz)-Above 1G									
V	4434.200	64.67	5.94	35.40	44.00	62.01	68.2	-6.19	PK
V	4434.200	43.83	5.94	35.40	44.00	41.17	54	-12.83	AV
V	10380.172	60.82	8.46	39.75	44.50	64.53	68.2	-3.67	PK
V	10380.172	43.41	8.46	39.75	44.50	47.12	54	-6.88	AV
V	15570.122	60.37	10.12	38.80	44.10	65.19	74	-8.81	PK
V	15570.122	43.14	10.12	38.80	42.70	49.36	54	-4.64	AV
H	4434.167	64.19	5.94	35.18	44.00	61.31	74	-12.69	PK
H	4434.167	43.00	5.94	35.18	44.00	40.12	54	-13.88	AV
H	10380.095	53.86	8.46	38.71	44.50	56.53	68.2	-11.67	PK
H	10380.095	41.54	8.46	38.71	44.50	44.21	54	-9.79	AV
H	15570.033	52.89	10.12	38.38	44.10	57.29	74	-16.71	PK
H	15570.033	42.51	10.12	38.38	44.10	46.91	54	-7.09	AV
High Channel (5230 MHz)-Above 1G									
V	4739.189	64.93	6.48	36.35	44.05	63.71	68.2	-4.49	PK
V	4739.189	43.80	6.48	36.35	44.05	42.58	54	-11.42	AV
V	10460.074	63.87	8.47	37.88	44.51	65.71	68.2	-2.49	PK
V	10460.074	43.85	8.47	37.88	44.51	45.69	54	-8.31	AV
V	15690.016	62.04	10.12	38.80	44.10	66.86	74	-7.14	PK
V	15690.016	44.00	10.12	38.80	42.70	50.22	54	-3.78	AV
H	4739.059	62.67	6.48	36.37	44.05	61.47	68.2	-6.73	PK
H	4739.059	43.95	6.48	36.37	44.05	42.75	54	-11.25	AV
H	10460.132	51.05	8.47	38.64	44.50	53.66	68.2	-14.54	PK
H	10460.132	40.25	8.47	38.64	44.50	42.86	54	-11.14	AV
H	15690.081	52.33	10.12	38.38	44.10	56.73	74	-17.27	PK
H	15690.081	42.54	10.12	38.38	44.10	46.94	54	-7.06	AV

Note: PK value is lower than the Average value limit, So average didn't record.
 The 26.5-40G amplitude of spurious emissions that are attenuated by more than 20dB below the permissible value has no need to be reported.
 Emission level (dBuV/m) = 20 log Emission level (uV/m).
 Corrected Reading: Antenna Factor + Cable Loss + Read Level - Preamp Factor = Level.

Test Mode:	TX(5.1G) - 802.11ac-HT20
------------	--------------------------

Polar (H/V)	Frequency	Meter Reading	Cable loss	Antenna Factor	Preamp Factor	Emission Level	Limits	Margin	Detector Type
	(MHz)	(dBuV)	(dB)	dB/m	(dB)	(dBuV/m)	(dBuV/m)	(dB)	
Low Channel (5180 MHz)-Above 1G									
V	4434.060	63.56	5.94	35.40	44.00	60.90	68.2	-7.30	PK
V	4434.060	43.68	5.94	35.40	44.00	41.02	54	-12.98	AV
V	10360.139	60.77	8.46	39.75	44.50	64.48	68.2	-3.72	PK
V	10360.139	43.64	8.46	39.75	44.50	47.35	54	-6.65	AV
V	15540.135	61.07	10.12	38.80	44.10	65.89	74	-8.11	PK
V	15540.135	43.40	10.12	38.80	42.70	49.62	54	-4.38	AV
H	4434.085	63.01	5.94	35.18	44.00	60.13	68.2	-8.07	PK
H	4434.085	43.38	5.94	35.18	44.00	40.50	54	-13.50	AV
H	10360.106	54.70	8.46	38.71	44.50	57.37	68.2	-10.83	PK
H	10360.106	44.23	8.46	38.71	44.50	46.90	54	-7.10	AV
H	15540.025	54.60	10.12	38.38	44.10	59.00	74	-15.00	PK
H	15540.025	40.49	10.12	38.38	44.10	44.89	54	-9.11	AV
Middle Channel (5200 MHz)-Above 1G									
V	4592.166	63.47	6.48	36.35	44.05	62.25	74	-11.75	PK
V	4592.166	43.02	6.48	36.35	44.05	41.80	54	-12.20	AV
V	10400.137	63.88	8.47	37.88	44.51	65.72	68.2	-2.48	PK
V	10400.137	43.66	8.47	37.88	44.51	45.50	54	-8.50	AV
V	15600.015	61.66	10.12	38.80	44.10	66.48	74	-7.52	PK
V	15600.015	43.02	10.12	38.80	42.70	49.24	54	-4.76	AV
H	4592.089	62.55	6.48	36.37	44.05	61.35	74	-12.65	PK
H	4592.089	43.67	6.48	36.37	44.05	42.47	54	-11.53	AV
H	10400.135	54.43	8.47	38.64	44.50	57.04	68.2	-11.16	PK
H	10400.135	40.11	8.47	38.64	44.50	42.72	54	-11.28	AV
H	15600.058	52.54	10.12	38.38	44.10	56.94	74	-17.06	PK
H	15600.058	41.62	10.12	38.38	44.10	46.02	54	-7.98	AV
High Channel (5240 MHz)-Above 1G									
V	4739.071	61.41	7.10	37.24	43.50	62.25	74	-11.75	PK
V	4739.071	43.78	7.10	37.24	43.50	44.62	54	-9.38	AV
V	10480.015	63.90	8.46	37.68	44.50	65.54	68.2	-2.66	PK
V	10480.015	43.99	8.46	37.68	44.50	45.63	54	-8.37	AV
V	15720.171	62.98	10.12	38.80	44.10	67.80	74	-6.20	PK
V	15720.171	43.08	10.12	38.80	42.70	49.30	54	-4.70	AV
H	4739.125	61.14	7.10	37.24	43.50	61.98	74	-12.02	PK
H	4739.125	43.79	7.10	37.24	43.50	44.63	54	-9.37	AV
H	10480.090	53.31	8.46	38.57	44.50	55.84	68.2	-12.36	PK
H	10480.090	44.87	8.46	38.57	44.50	47.40	54	-6.60	AV
H	15720.147	53.41	10.12	38.38	44.10	57.81	74	-16.19	PK
H	15720.147	44.76	10.12	38.38	44.10	49.16	54	-4.84	AV

Note: PK value is lower than the Average value limit, So average didn't record.
 The 26.5-40G amplitude of spurious emissions that are attenuated by more than 20dB below the permissible value has no need to be reported.
 Emission level (dBuV/m) = 20 log Emission level (uV/m).
 Corrected Reading: Antenna Factor + Cable Loss + Read Level - Preamp Factor = Level.

Test Mode:	TX(5.1G) - 802.11ac-HT40
------------	--------------------------

Polar (H/V)	Frequency	Meter Reading	Cable loss	Antenna Factor	Preamp Factor	Emission Level	Limits	Margin	Detector Type
	(MHz)	(dBuV)	(dB)	dB/m	(dB)	(dBuV/m)	(dBuV/m)	(dB)	
Low Channel (5190 MHz)-Above 1G									
V	4434.085	64.65	5.94	35.40	44.00	61.99	68.2	-6.21	PK
V	4434.085	43.15	5.94	35.40	44.00	40.49	54	-13.51	AV
V	10380.055	60.49	8.46	39.75	44.50	64.20	68.2	-4.00	PK
V	10380.055	43.56	8.46	39.75	44.50	47.27	54	-6.73	AV
V	15570.086	62.18	10.12	38.80	44.10	67.00	74	-7.00	PK
V	15570.086	43.92	10.12	38.80	42.70	50.14	54	-3.86	AV
H	4434.009	64.02	5.94	35.18	44.00	61.14	74	-12.86	PK
H	4434.009	43.50	5.94	35.18	44.00	40.62	54	-13.38	AV
H	10380.078	52.05	8.46	38.71	44.50	54.72	68.2	-13.48	PK
H	10380.078	42.45	8.46	38.71	44.50	45.12	54	-8.88	AV
H	15570.171	52.27	10.12	38.38	44.10	56.67	74	-17.33	PK
H	15570.171	44.78	10.12	38.38	44.10	49.18	54	-4.82	AV
High Channel (5230 MHz)-Above 1G									
V	4739.196	62.92	6.48	36.35	44.05	61.70	68.2	-6.50	PK
V	4739.196	43.90	6.48	36.35	44.05	42.68	54	-11.32	AV
V	10460.161	61.68	8.47	37.88	44.51	63.52	68.2	-4.68	PK
V	10460.161	43.63	8.47	37.88	44.51	45.47	54	-8.53	AV
V	15690.018	64.17	10.12	38.80	44.10	68.99	74	-5.01	PK
V	15690.018	43.74	10.12	38.80	42.70	49.96	54	-4.04	AV
H	4739.158	60.16	6.48	36.37	44.05	58.96	68.2	-9.24	PK
H	4739.158	43.56	6.48	36.37	44.05	42.36	54	-11.64	AV
H	10460.108	53.74	8.47	38.64	44.50	56.35	68.2	-11.85	PK
H	10460.108	44.04	8.47	38.64	44.50	46.65	54	-7.35	AV
H	15690.054	54.14	10.12	38.38	44.10	58.54	74	-15.46	PK
H	15690.054	41.57	10.12	38.38	44.10	45.97	54	-8.03	AV

Note: PK value is lower than the Average value limit, So average didn't record.

The 26.5-40G amplitude of spurious emissions that are attenuated by more than 20dB below the permissible value has no need to be reported.

Emission level (dBuV/m) = 20 log Emission level (uV/m).

Corrected Reading: Antenna Factor + Cable Loss + Read Level - Preamp Factor = Level.

Test Mode:	TX(5.1G) - 802.11ac-HT80
------------	--------------------------

Polar (H/V)	Frequency	Meter Reading	Cable loss	Antenna Factor	Preamp Factor	Emission Level	Limits	Margin	Detector Type
	(MHz)	(dBuV)	(dB)	dB/m	(dB)	(dBuV/m)	(dBuV/m)	(dB)	
(5210 MHz)-Above 1G									
V	4434.122	63.13	5.94	35.40	44.00	60.47	68.2	-7.73	PK
V	4434.122	43.28	5.94	35.40	44.00	40.62	54	-13.38	AV
V	10420.198	61.16	8.46	39.75	44.50	64.87	68.2	-3.33	PK
V	10420.198	43.80	8.46	39.75	44.50	47.51	54	-6.49	AV
V	15630.061	63.58	10.12	38.80	44.10	68.40	74	-5.60	PK
V	15630.061	43.20	10.12	38.80	42.70	49.42	54	-4.58	AV
H	4434.076	64.66	5.94	35.18	44.00	61.78	68.2	-6.42	PK
H	4434.076	43.46	5.94	35.18	44.00	40.58	54	-13.42	AV
H	10420.153	50.94	8.46	38.71	44.50	53.61	68.2	-14.59	PK
H	10420.153	41.53	8.46	38.71	44.50	44.20	54	-9.80	AV
H	15630.112	51.89	10.12	38.38	44.10	56.29	74	-17.71	PK
H	15630.112	44.35	10.12	38.38	44.10	48.75	54	-5.25	AV

Note: PK value is lower than the Average value limit, So average didn't record.
 The 26.5-40G amplitude of spurious emissions that are attenuated by more than 20dB below the permissible value has no need to be reported.
 Emission level (dBuV/m) = 20 log Emission level (uV/m).
 Corrected Reading: Antenna Factor + Cable Loss + Read Level - Preamp Factor = Level.

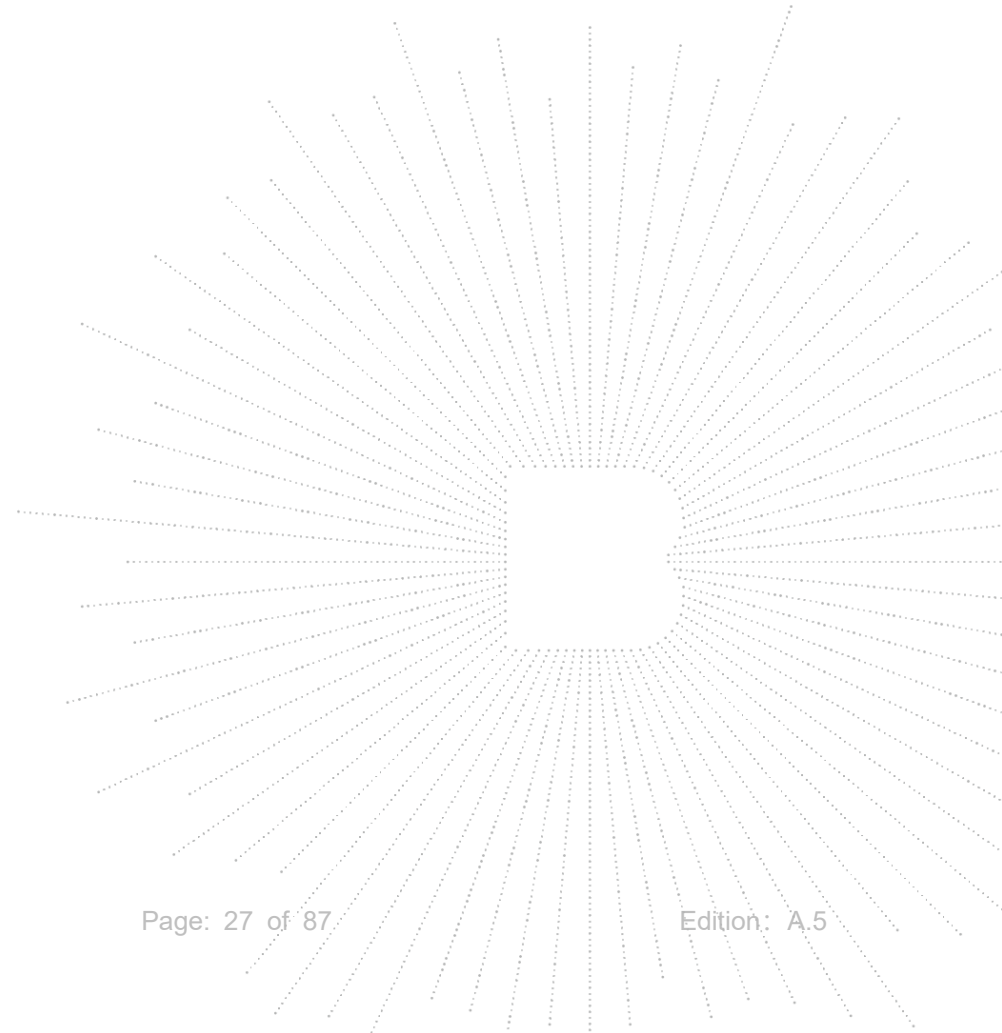

8. Power Spectral Density Test

8.1 Block Diagram Of Test Setup



8.2 Limit

For the band 5.15-5.25 GHz,

(i) For an outdoor Wifi Repeater operating in the band 5.15-5.25 GHz, the maximum power spectral density shall not exceed 17 dBm in any 1 megahertz band. If transmitting antennas of directional gain greater than 6 dBi are used, both the maximum conducted output power and the maximum power spectral density shall be reduced by the amount in dB that the directional gain of the antenna exceeds 6 dBi. The maximum e.i.r.p. at any elevation angle above 30 degrees as measured from the horizon must not exceed 125 mW (21 dBm).

(ii) For an indoor Wifi Repeater operating in the band 5.15-5.25 GHz, the maximum power spectral density shall not exceed 17 dBm in any 1 megahertz band. If transmitting antennas of directional gain greater than 6 dBi are used, both the maximum conducted output power and the maximum power spectral density shall be reduced by the amount in dB that the directional gain of the antenna exceeds 6 dBi.

(iii) For fixed point-to-point Wifi Repeaters operating in the band 5.15-5.25 GHz, the maximum power spectral density shall not exceed 17 dBm in any 1 megahertz band. Fixed point-to-point U-NII devices may employ antennas with directional gain up to 23 dBi without any corresponding reduction in the maximum conducted output power or maximum power spectral density. For fixed point-to-point transmitters that employ a directional antenna gain greater than 23 dBi, a 1 dB reduction in maximum conducted output power and maximum power spectral density is required for each 1 dB of antenna gain in excess of 23 dBi. Fixed, point-to-point operations exclude the use of point-to-multipoint systems, omnidirectional applications, and multiple collocated transmitters transmitting the same information. The operator of the U-NII device, or if the equipment is professionally installed, the installer, is responsible for ensuring that systems employing high gain directional antennas are used exclusively for fixed, point-to-point operations.

(iv) For client devices in the 5.15-5.25 GHz band, the maximum power spectral density shall not exceed 11 dBm in any 1 megahertz band. If transmitting antennas of directional gain greater than 6 dBi are used, both the maximum conducted output power and the maximum power spectral density shall be reduced by the amount in dB that the directional gain of the antenna exceeds 6 dBi.

For the band 5.725-5.85 GHz

(3) For the band 5.725-5.85 GHz, the maximum power spectral density shall not exceed 30 dBm in any 500-kHz band. If transmitting antennas of directional gain greater than 6 dBi are used, both the maximum conducted output power and the maximum power spectral density shall be reduced by the amount in dB that the directional gain of the antenna exceeds 6 dBi.

8.3 Test procedure

For devices operating in the bands 5.15-5.25 GHz, 5.25-5.35 GHz, and 5.47-5.725 GHz, the above procedures make use of 1 MHz RBW to satisfy directly the 1 MHz reference bandwidth specified in § 15.407(a)(5). For devices operating in the band 5.725-5.85 GHz, the rules specify a measurement bandwidth of 500 kHz. Many spectrum analyzers do not have 500 kHz RBW, thus a narrower RBW may need to be used. The rules permit the use of a RBWs less than 1 MHz, or 500 kHz, “provided that the measured power is integrated over the full reference bandwidth” to show the total power over the specified measurement bandwidth (i.e., 1 MHz, or 500 kHz). If measurements are performed using a reduced resolution bandwidth (< 1 MHz, or < 500 kHz) and integrated over 1 MHz, or 500 kHz bandwidth, the following adjustments to the procedures apply:

- a) Set $RBW \geq 1/T$, where T is defined in section II.B.I.a).
- b) Set $VBW \geq 3 RBW$.
- c) If measurement bandwidth of Maximum PSD is specified in 500 kHz, add $10\log(500\text{kHz}/RBW)$ to the measured result, whereas RBW (< 500 kHz) is the reduced resolution bandwidth of the spectrum analyzer set during measurement.
- d) If measurement bandwidth of Maximum PSD is specified in 1 MHz, add $10\log(1\text{MHz}/RBW)$ to the measured result, whereas RBW (< 1 MHz) is the reduced resolution bandwidth of spectrum analyzer set during measurement.
- e) Care must be taken to ensure that the measurements are performed during a period of continuous transmission or are corrected upward for duty cycle.

Note: As a practical matter, it is recommended to use reduced RBW of 100 KHz for the sections 5.c) and 5.d) above, since RBW=100 KHz is available on nearly all spectrum analyzers.

8.4 EUT operating Conditions

The EUT was configured for testing in a typical fashion (as a customer would normally use it). The EUT has been programmed to continuously transmit during test. This operating condition was tested and used to collect the included data.

8.5 Test Result

Temperature:	26 °C	Relative Humidity:	54%
Pressure:	101KPa	Test Voltage:	DC 5V
Test Mode:	(5180-5240MHz)		

Condition	Mode	Frequency (MHz)	Conducted PSD (dBm)	Limit (dBm)	Verdict
NVNT	a	5180	-2.03	11	Pass
NVNT	a	5200	-2.66	11	Pass
NVNT	a	5240	-1.69	11	Pass
NVNT	n20	5180	-5.30	11	Pass
NVNT	n20	5200	-2.11	11	Pass
NVNT	n20	5240	-1.74	11	Pass
NVNT	n40	5190	-10.68	11	Pass
NVNT	n40	5230	-11.03	11	Pass
NVNT	ac20	5180	-4.50	11	Pass
NVNT	ac20	5200	-4.44	11	Pass
NVNT	ac20	5240	-7.24	11	Pass
NVNT	ac40	5190	-11.12	11	Pass
NVNT	ac40	5230	-8.99	11	Pass
NVNT	ac80	5210	-17.32	11	Pass

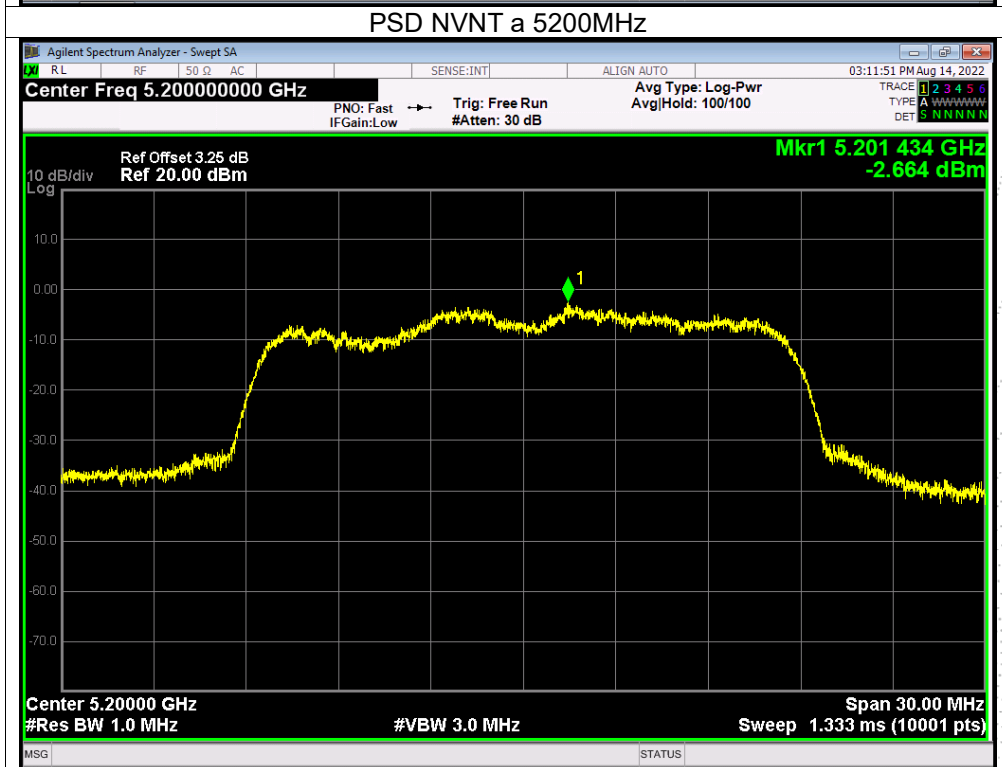
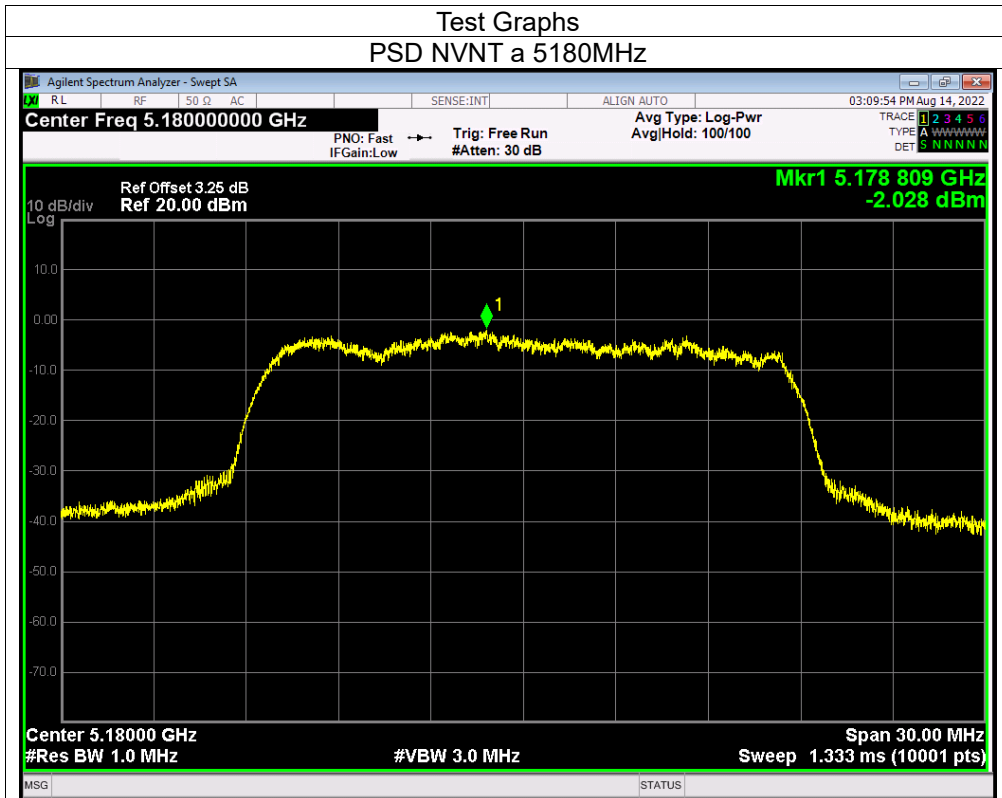

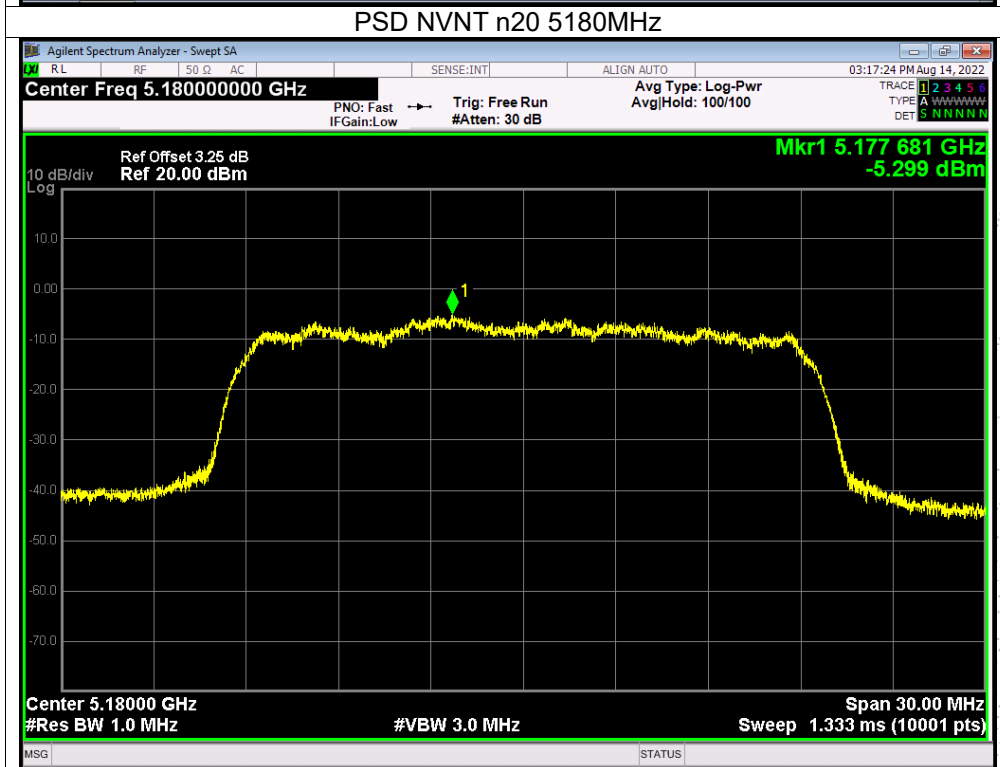
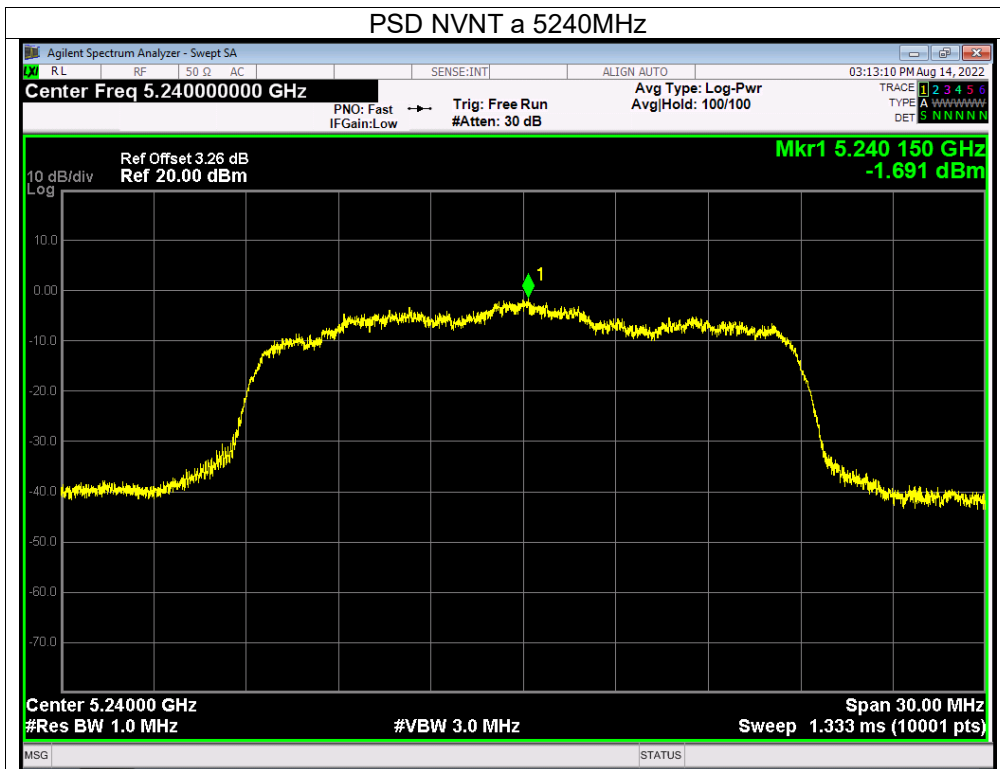

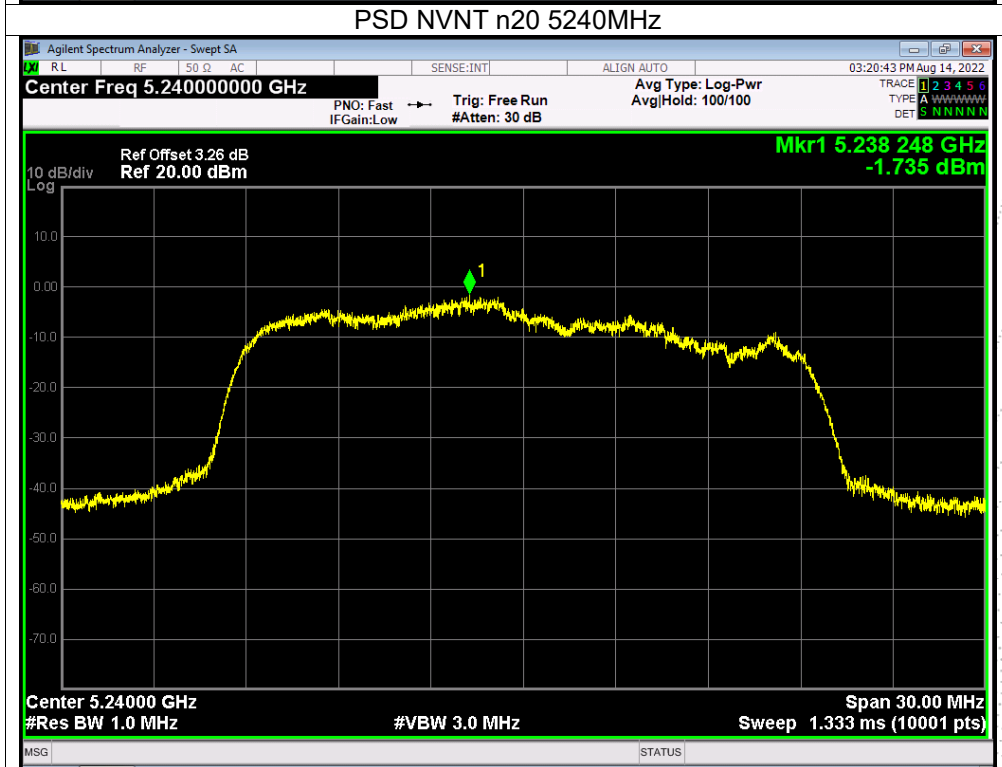
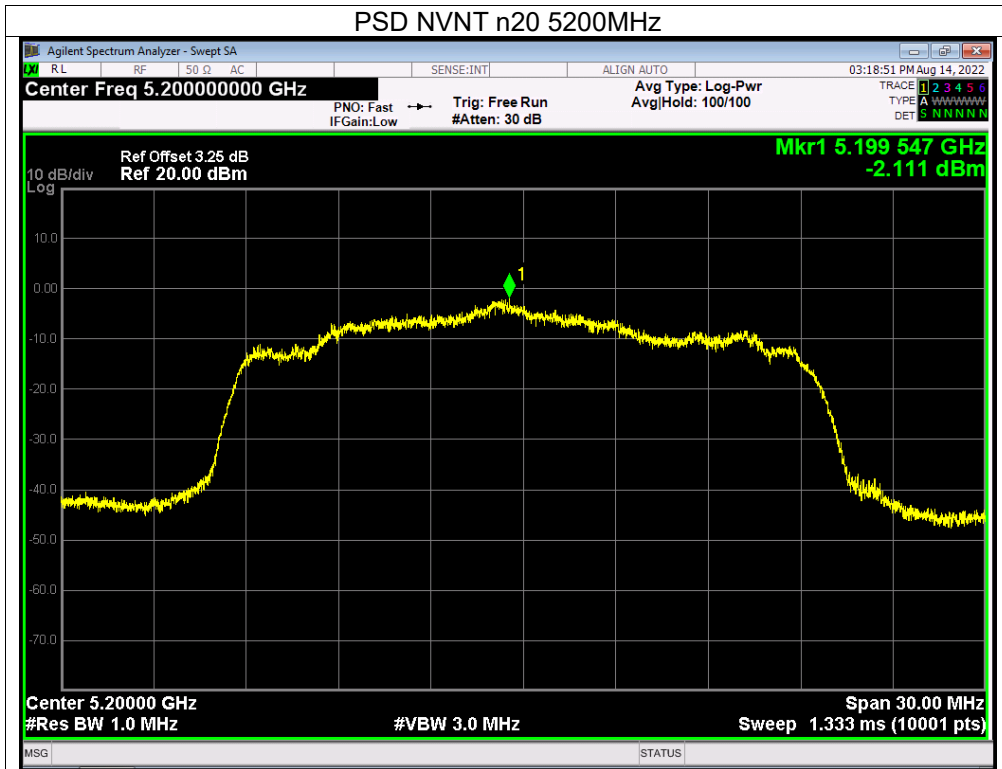

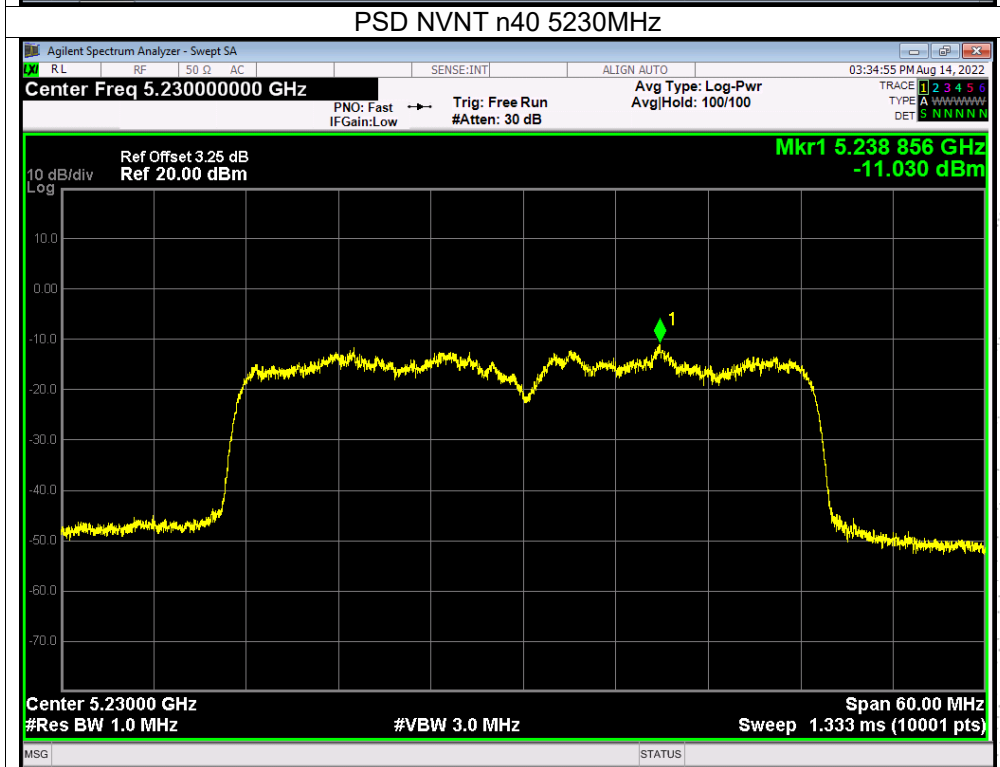
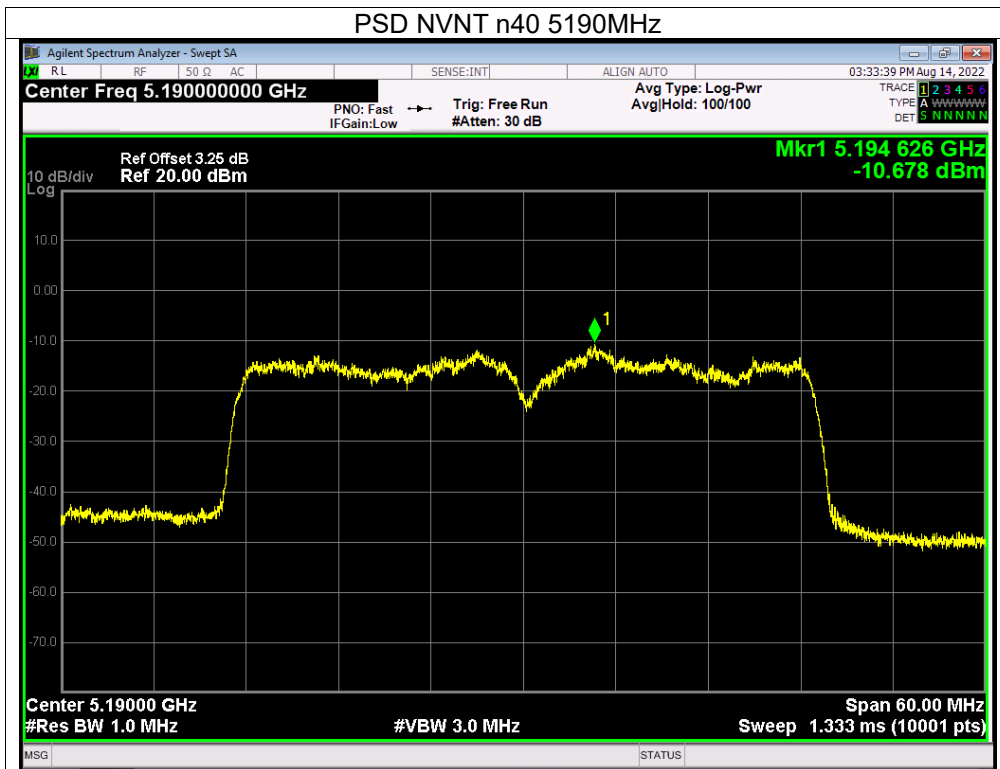

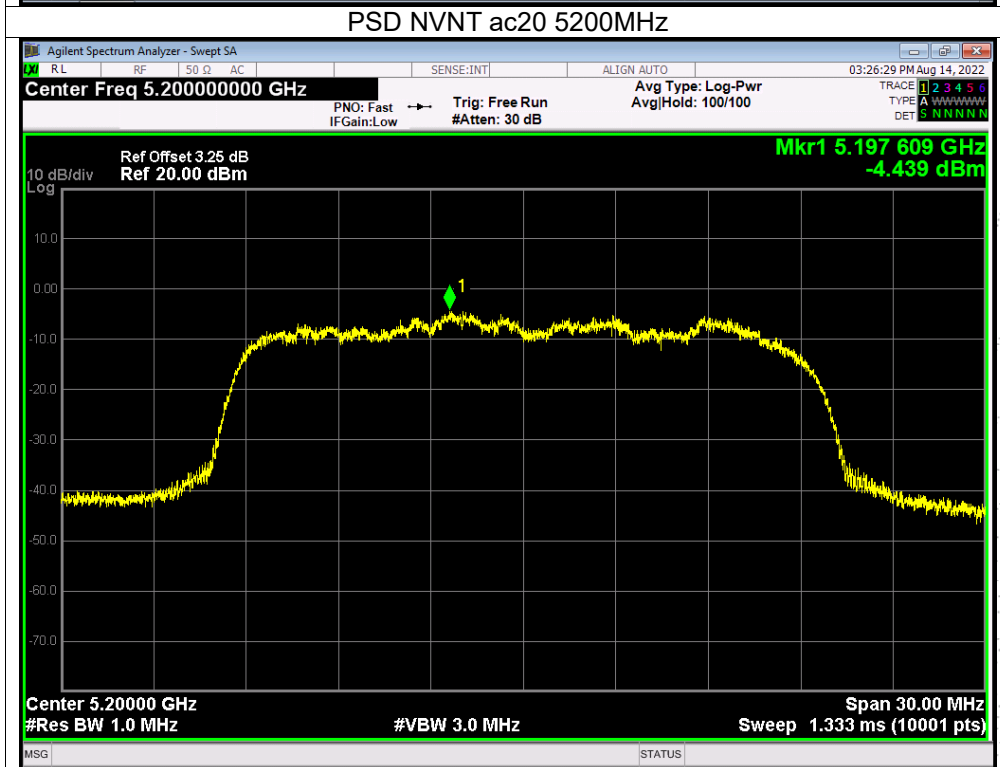
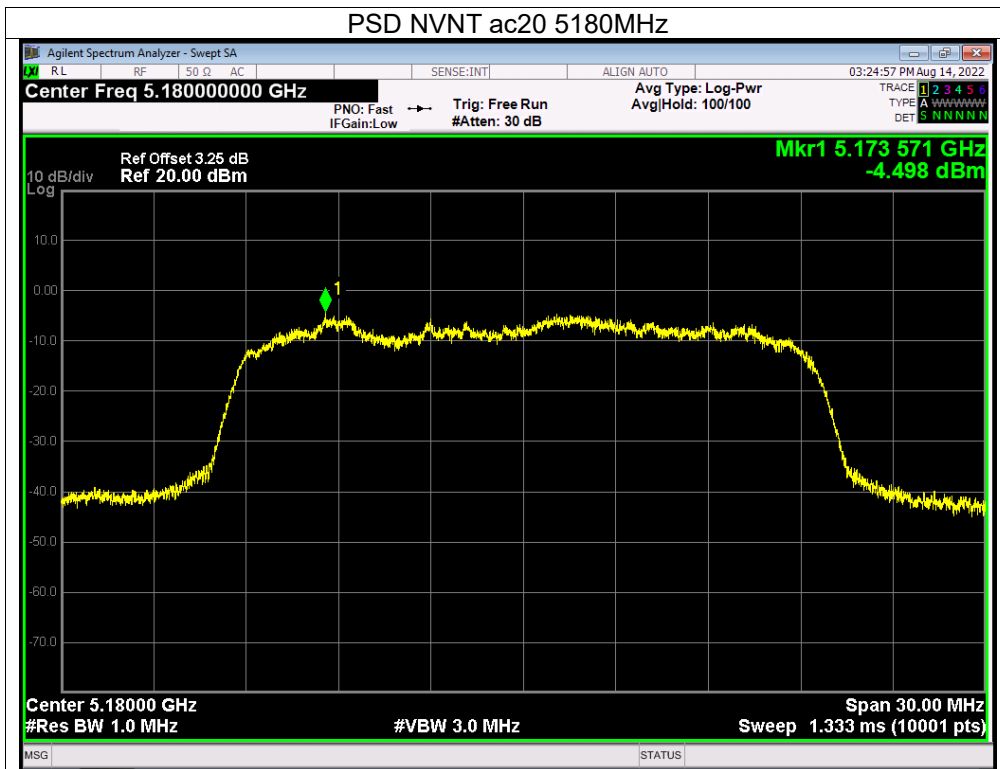

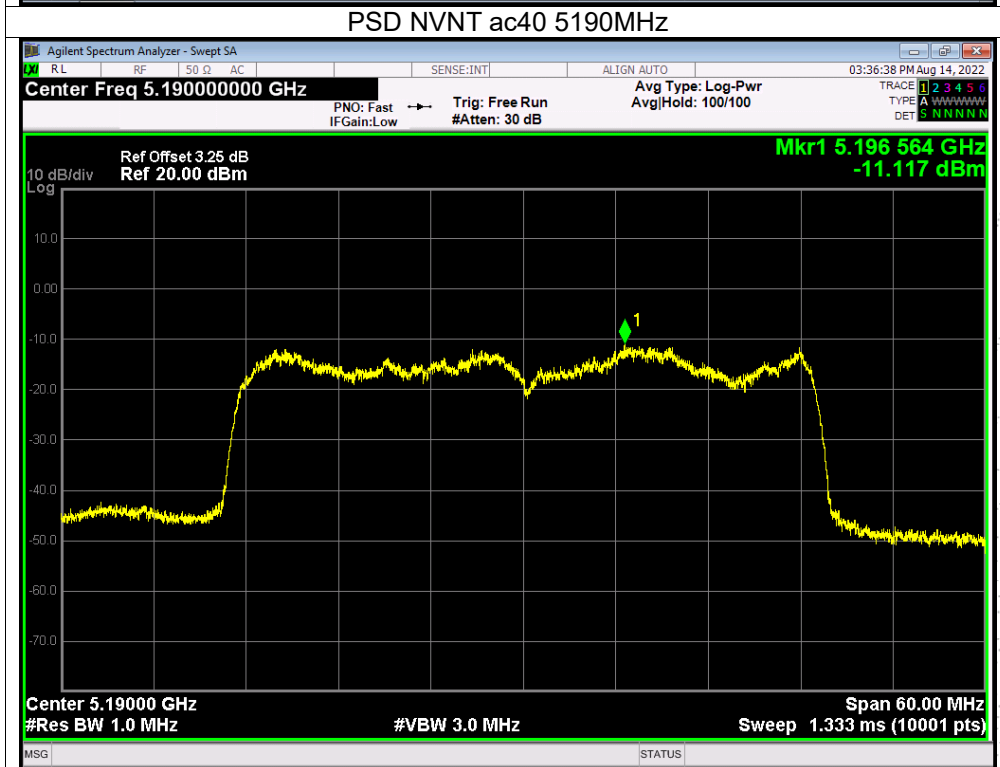
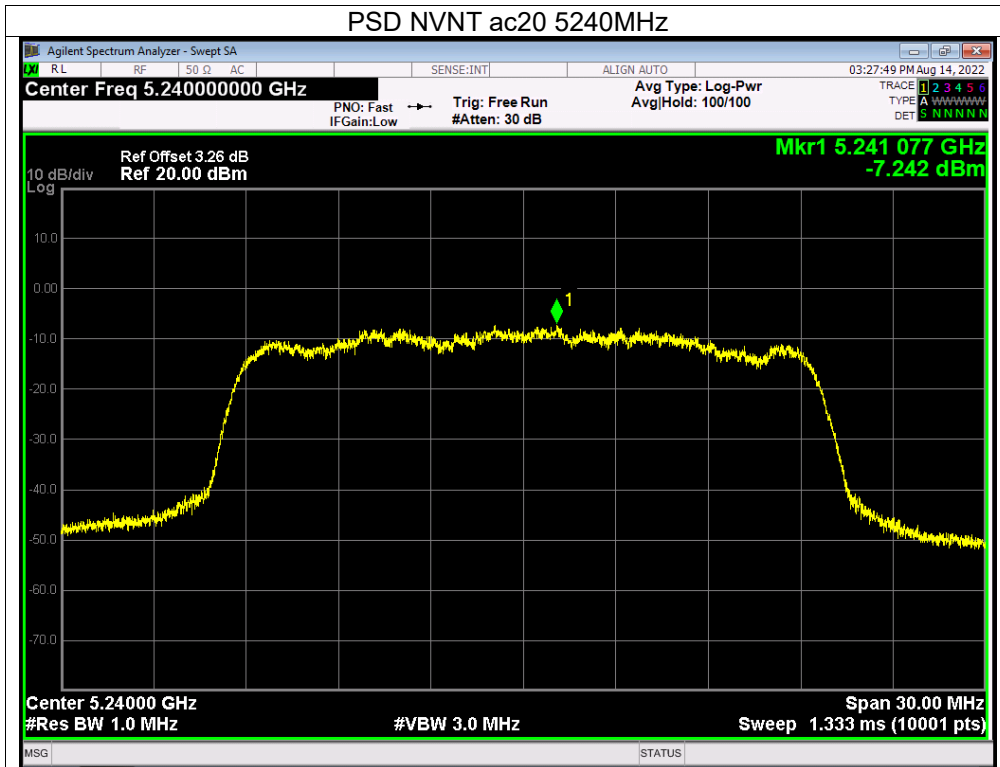

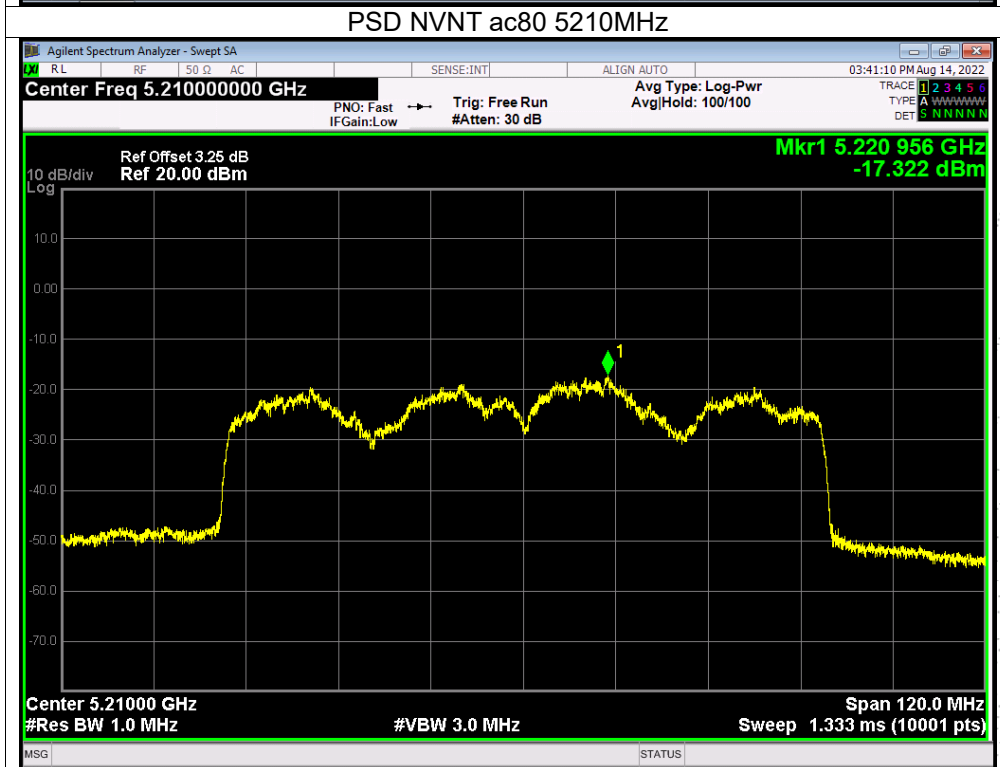
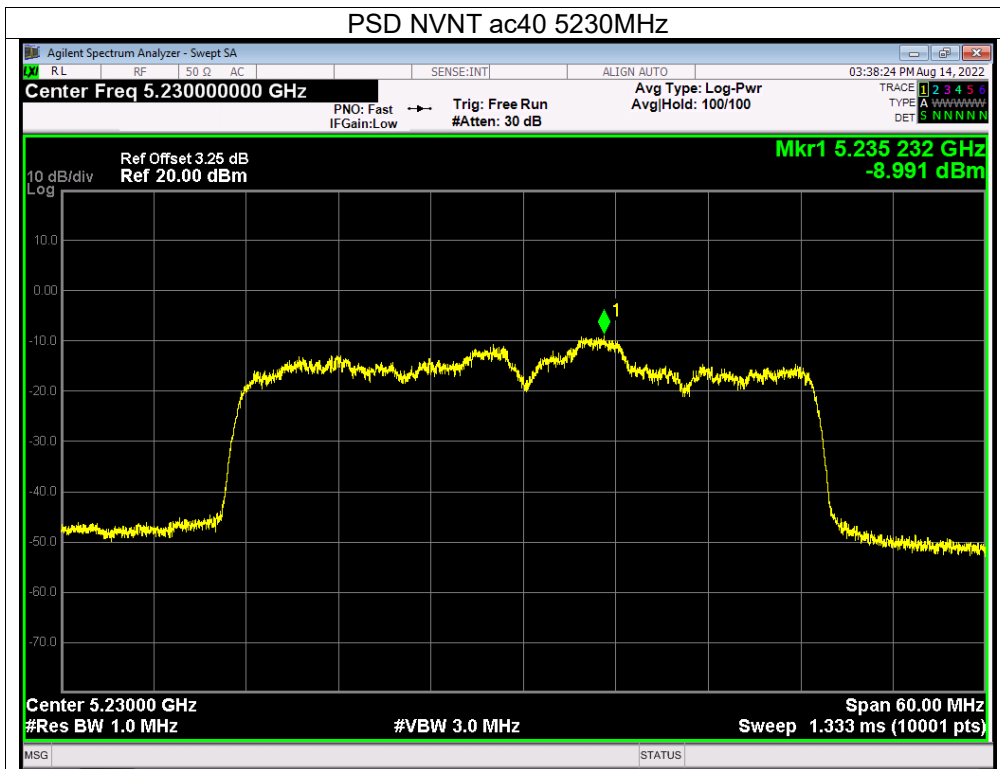

9. 26dB & 99% Emission Bandwidth

9.1 Block Diagram Of Test Setup

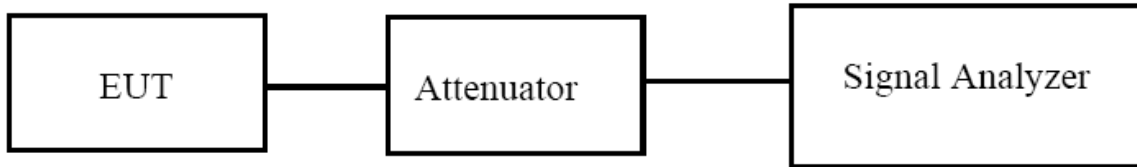

9.2 Limit

The maximum power spectral density is measured as a conducted emission by direct connection of a calibrated test instrument to the equipment under test. If the device cannot be connected directly, alternative techniques acceptable to the Commission may be used. Measurements in the 5.725-5.85 GHz band are made over a reference bandwidth of 500 kHz or the 26 dB emission bandwidth of the device, whichever is less. Measurements in the 5.15-5.25 GHz, 5.25-5.35 GHz, and the 5.47-5.725 GHz bands are made over a bandwidth of 1 MHz or the 26 dB emission bandwidth of the device, whichever is less. A narrower resolution bandwidth can be used, provided that the measured power is integrated over the full reference bandwidth.

9.3 Test procedure

a) Set RBW = approximately 1% of the emission bandwidth.

b) Set the VBW > RBW.

c) Detector = Peak.

d) Trace mode = max hold.

e) Measure the maximum width of the emission that is 26 dB down from the maximum of the emission. Compare this with the RBW setting of the analyzer. Readjust RBW and repeat measurement as needed until the RBW/EBW ratio is approximately 1%.

The following procedure shall be used for measuring (99 %) power bandwidth:

1. Set center frequency to the nominal EUT channel center frequency.

2. Set span = 1.5 times to 5.0 times the OBW.

3. Set RBW = 1 % to 5 % of the OBW

4. Set VBW $\geq 3 \cdot$ RBW

5. Video averaging is not permitted. Where practical, a sample detection and single sweep mode shall be used. Otherwise, peak detection and max hold mode (until the trace stabilizes) shall be used.

6. Use the 99 % power bandwidth function of the instrument (if available).

7. If the instrument does not have a 99 % power bandwidth function, the trace data points are recovered and directly summed in power units. The recovered amplitude data points, beginning at the lowest frequency, are placed in a running sum until 0.5 % of the total is reached; that frequency is recorded as the lower frequency. The process is repeated until 99.5 % of the total is reached; that frequency is recorded as the upper frequency. The 99% occupied bandwidth is the difference between these two frequencies.

9.4 EUT operating Conditions

The EUT was configured for testing in a typical fashion (as a customer would normally use it). The EUT has been programmed to continuously transmit during test. This operating condition was tested and used to collect the included data.

9.5 Test Result

Temperature:	26 °C	Relative Humidity:	54%
Pressure:	101KPa	Test Voltage:	DC 5V
Test Mode:	(5180-5240MHz)		

Condition	Mode	Frequency (MHz)	-26 dB Bandwidth (MHz)	Limit -26 dB Bandwidth (MHz)	Verdict
NVNT	a	5180	22.945	N/A	N/A
NVNT	a	5200	21.656	N/A	N/A
NVNT	a	5240	21.302	N/A	N/A
NVNT	n20	5180	21.322	N/A	N/A
NVNT	n20	5200	21.401	N/A	N/A
NVNT	n20	5240	21.524	N/A	N/A
NVNT	n40	5190	40.282	N/A	N/A
NVNT	n40	5230	40.418	N/A	N/A
NVNT	ac20	5180	21.643	N/A	N/A
NVNT	ac20	5200	21.257	N/A	N/A
NVNT	ac20	5240	21.529	N/A	N/A
NVNT	ac40	5190	43.501	N/A	N/A
NVNT	ac40	5230	40.433	N/A	N/A
NVNT	ac80	5210	80.898	N/A	N/A

Condition	Mode	Frequency (MHz)	99% OBW (MHz)
NVNT	a	5180	16.611
NVNT	a	5200	16.636
NVNT	a	5240	16.569
NVNT	n20	5180	17.730
NVNT	n20	5200	17.731
NVNT	n20	5240	17.703
NVNT	n40	5190	36.180
NVNT	n40	5230	36.170
NVNT	ac20	5180	17.738
NVNT	ac20	5200	17.760
NVNT	ac20	5240	17.707
NVNT	ac40	5190	36.197
NVNT	ac40	5230	36.136
NVNT	ac80	5210	75.471

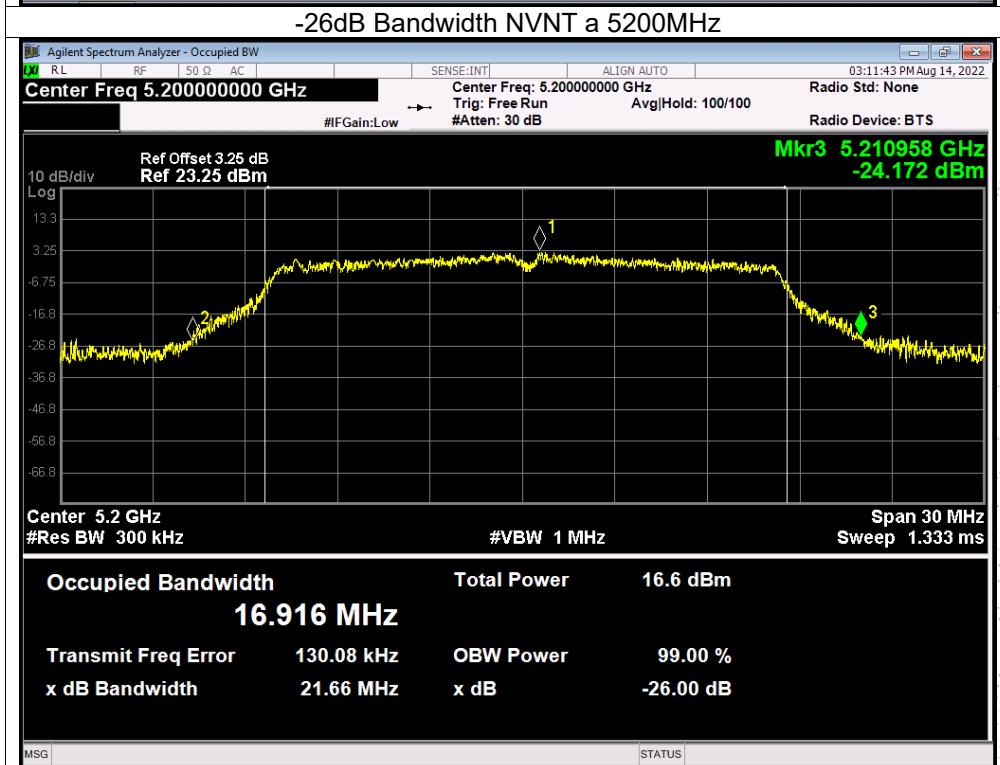
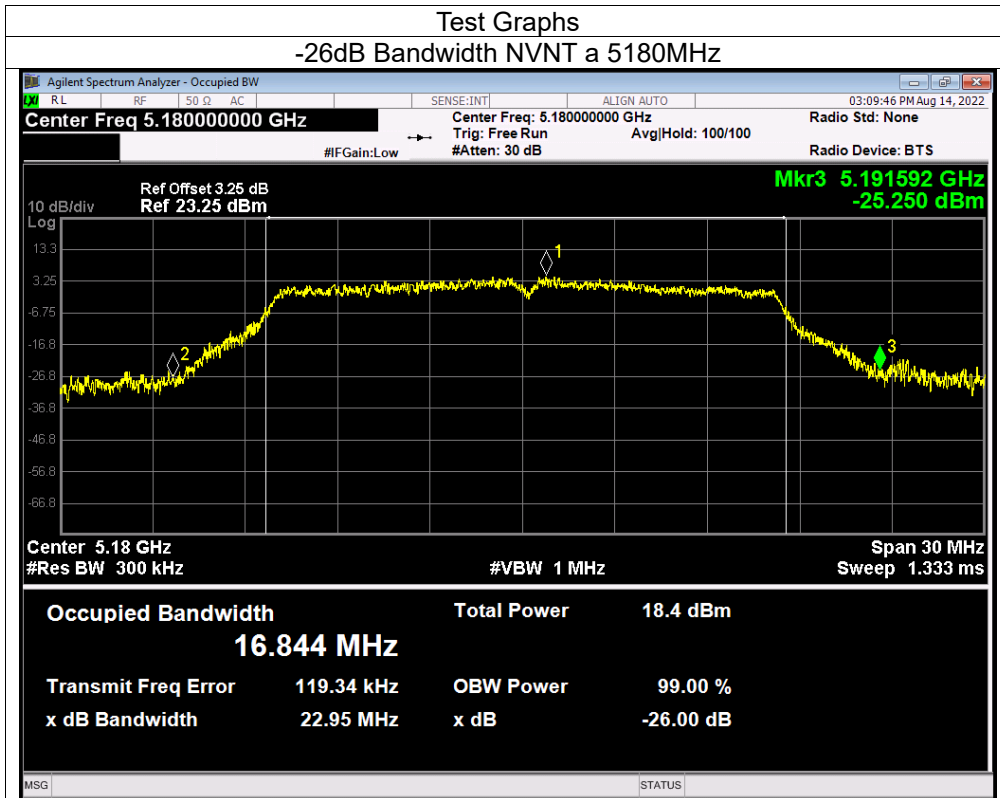

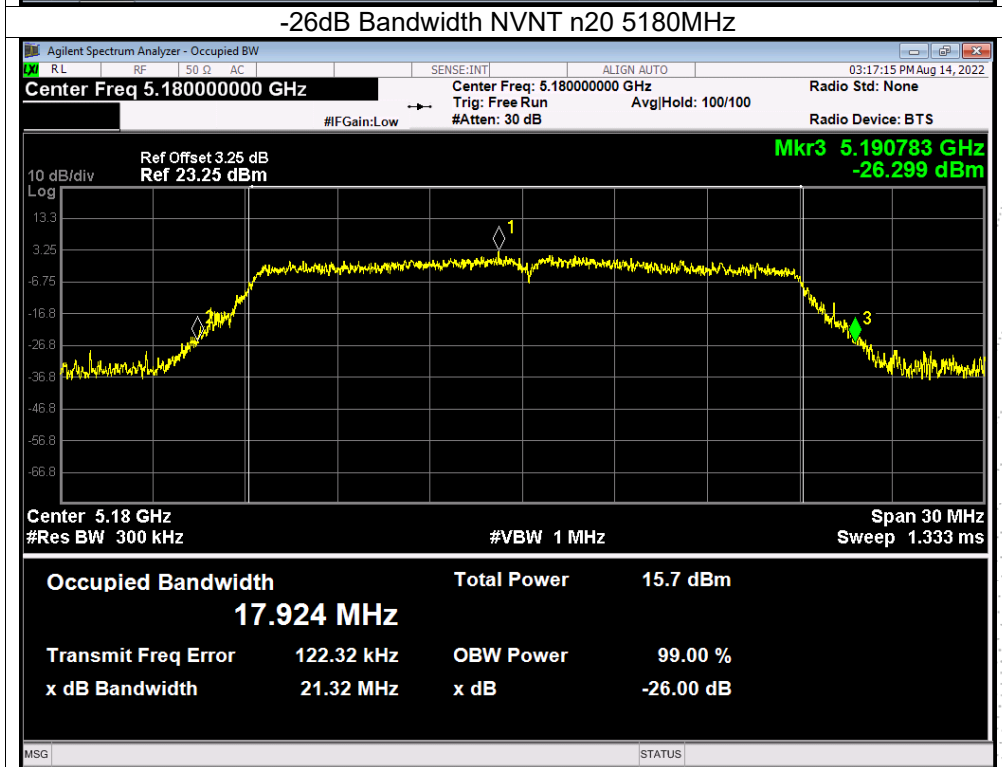
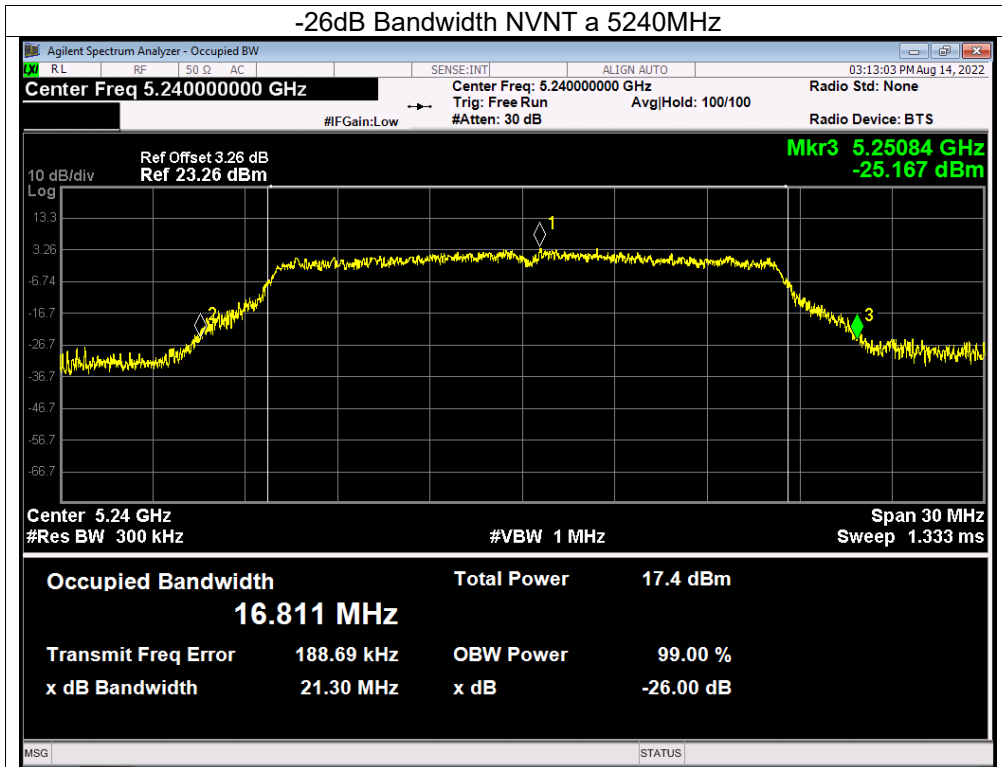

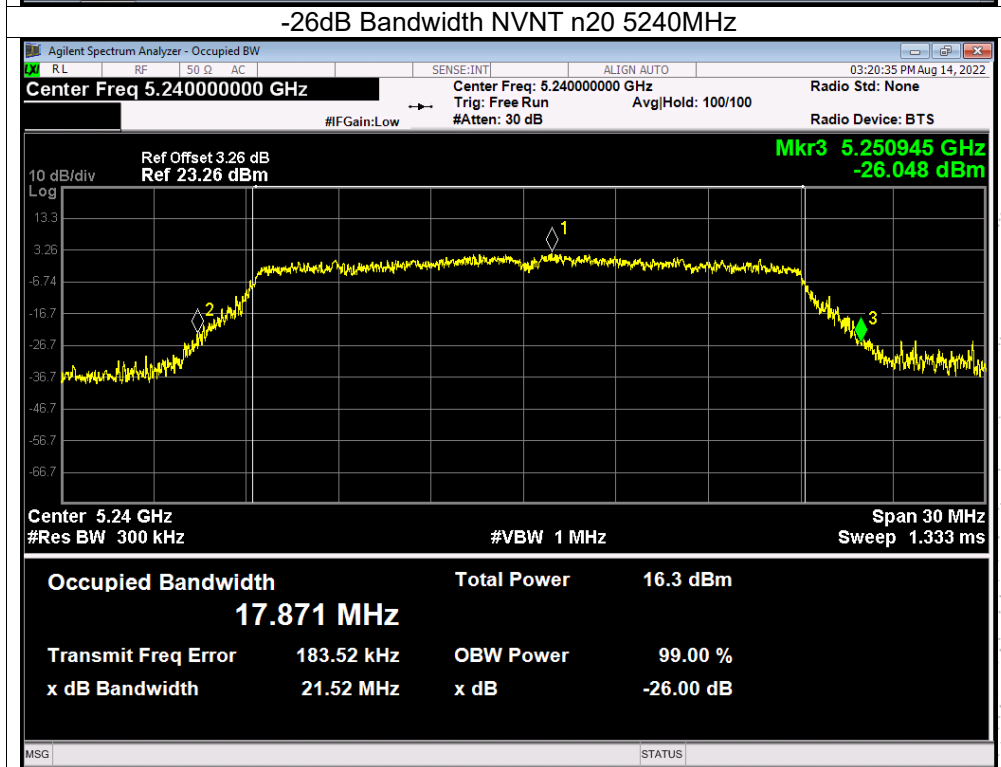
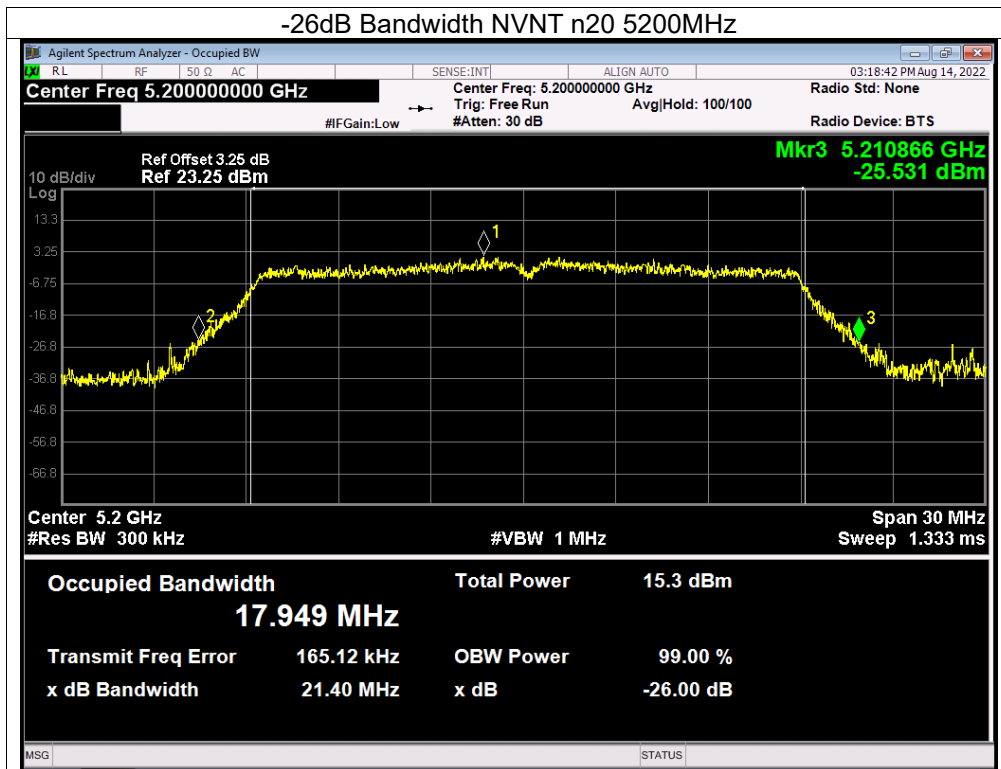

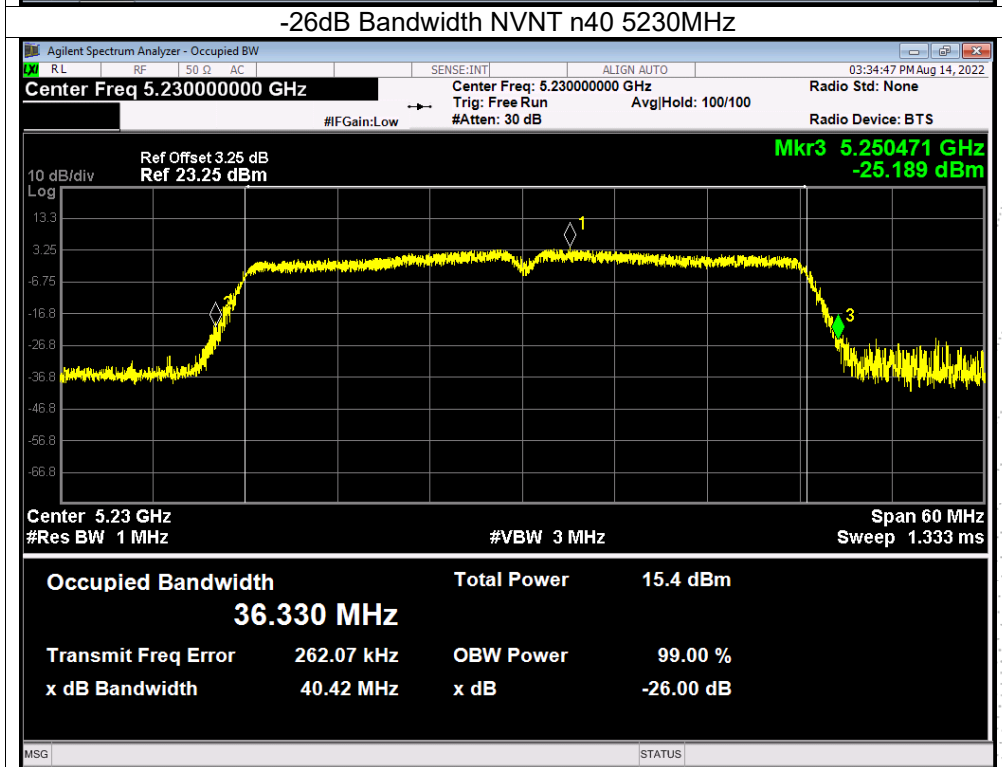
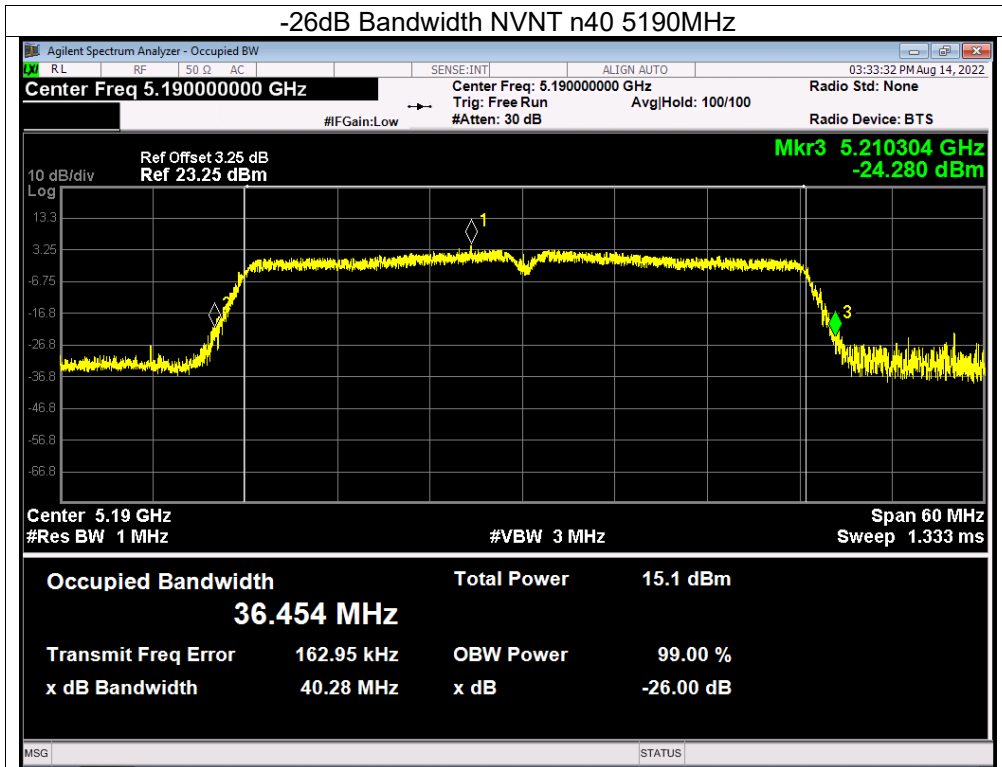

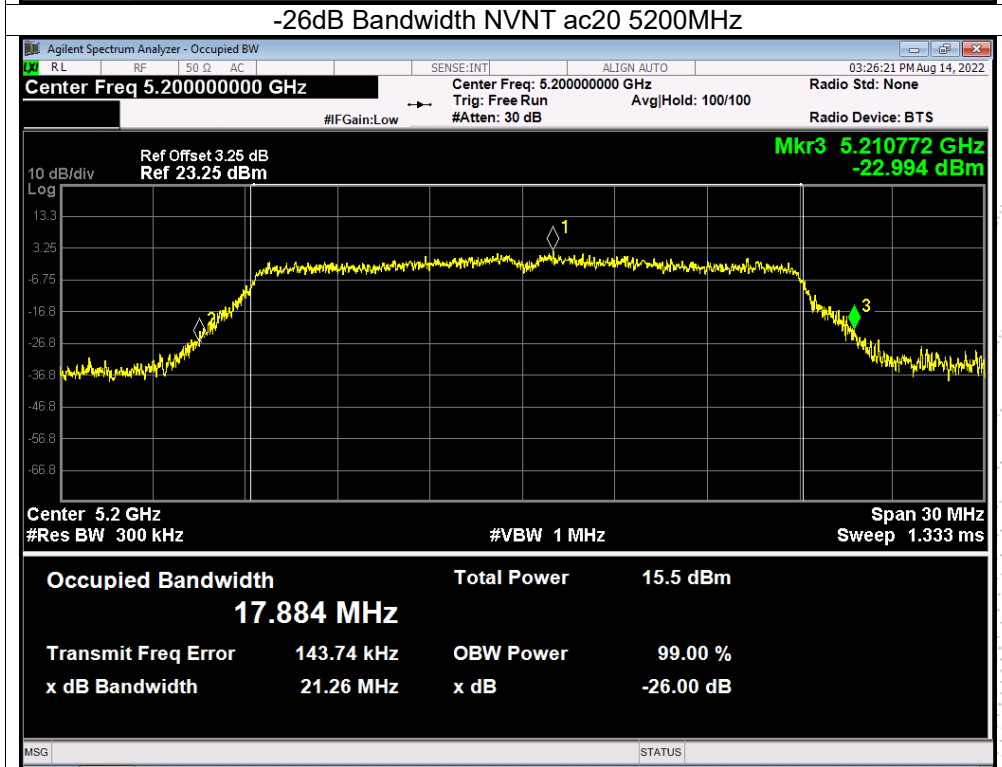
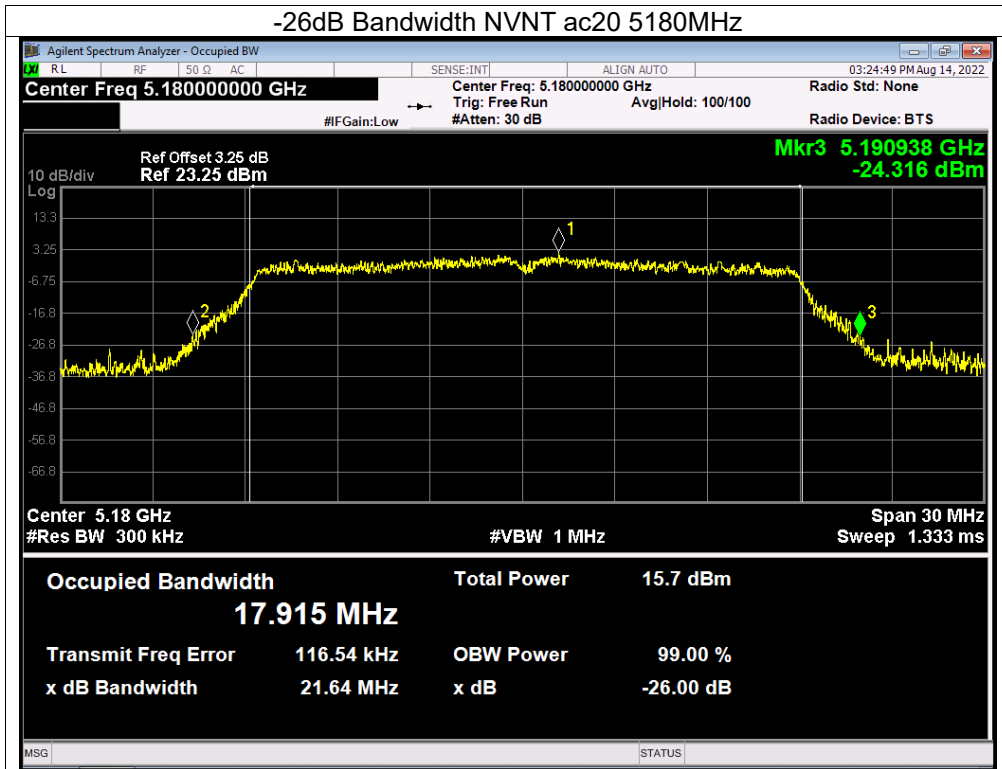

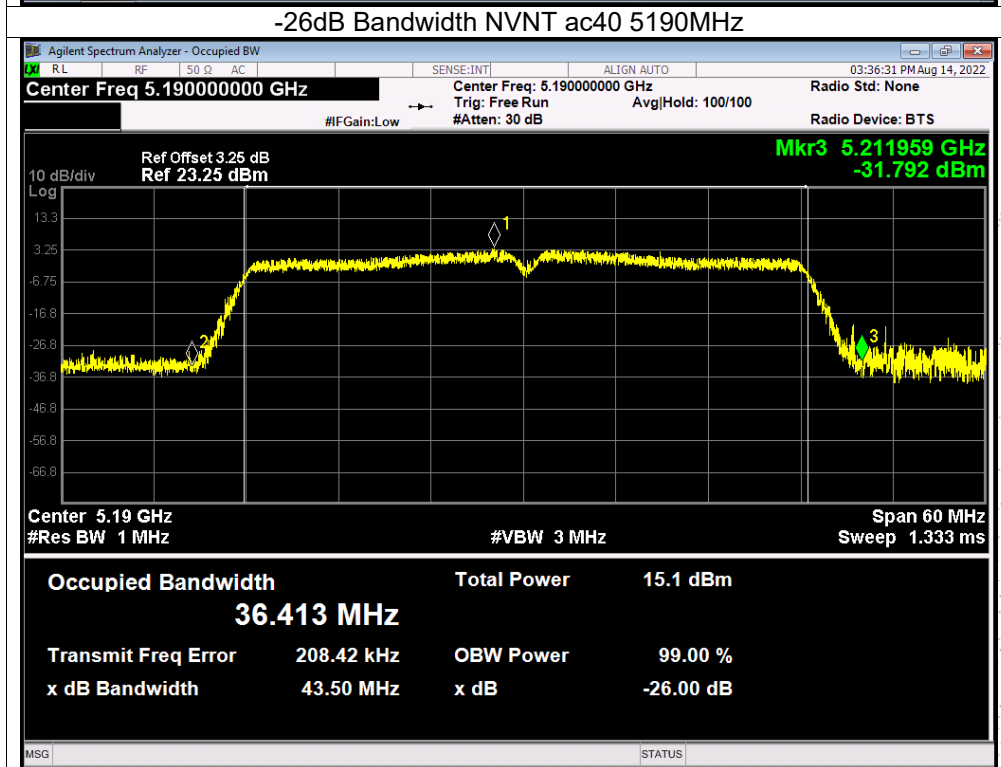
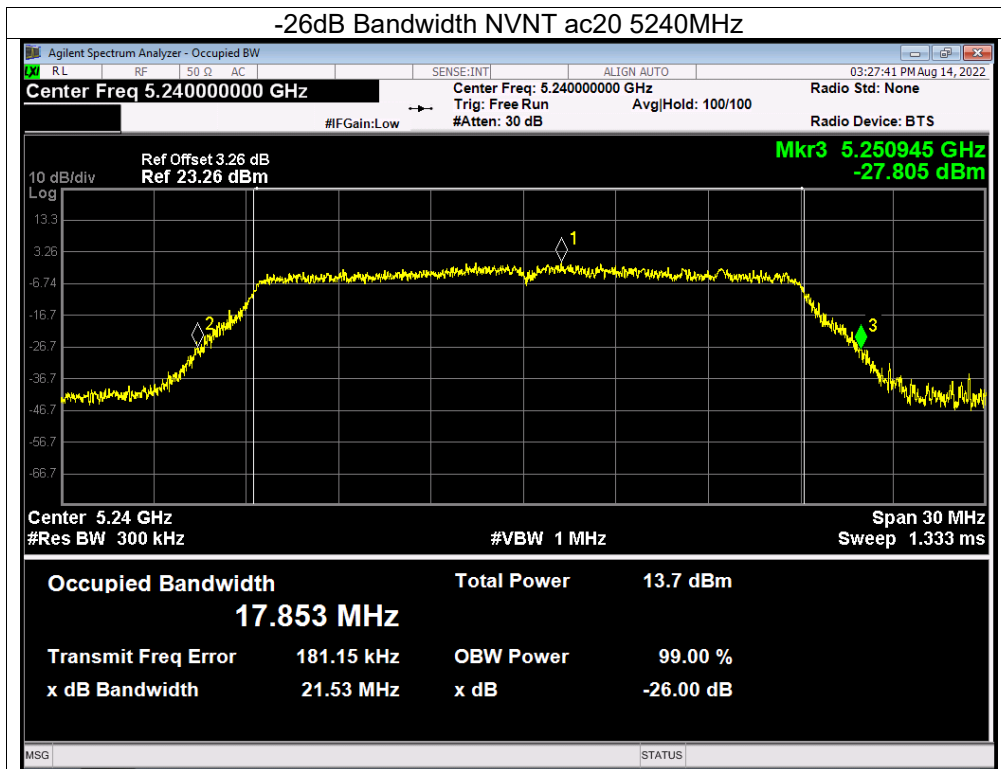

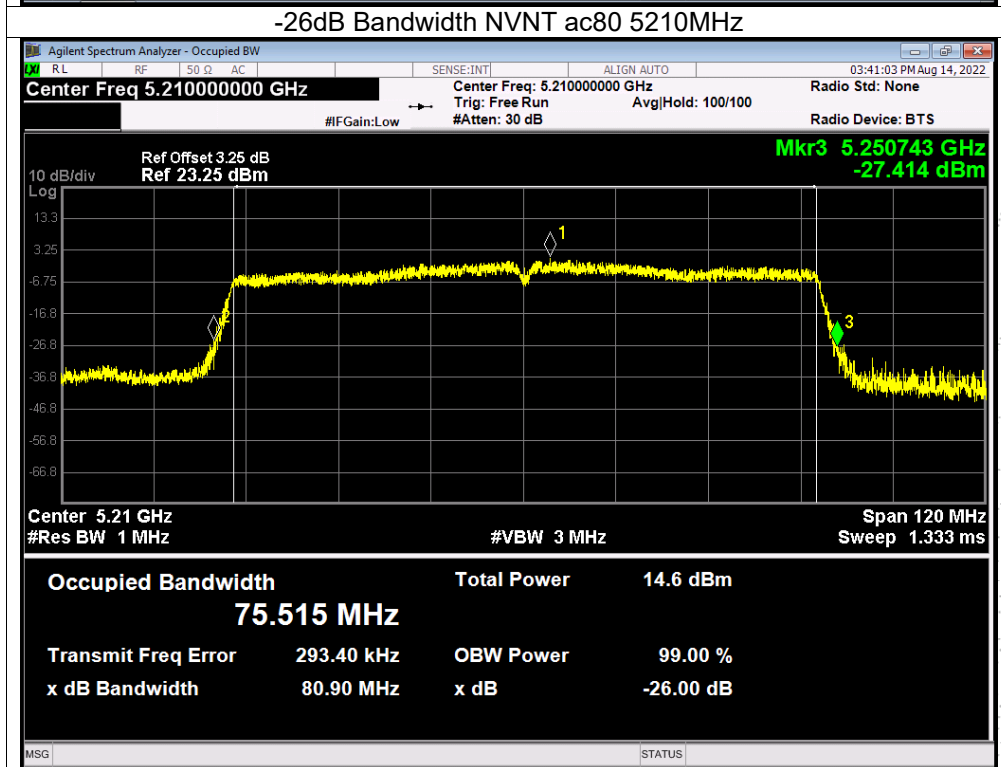
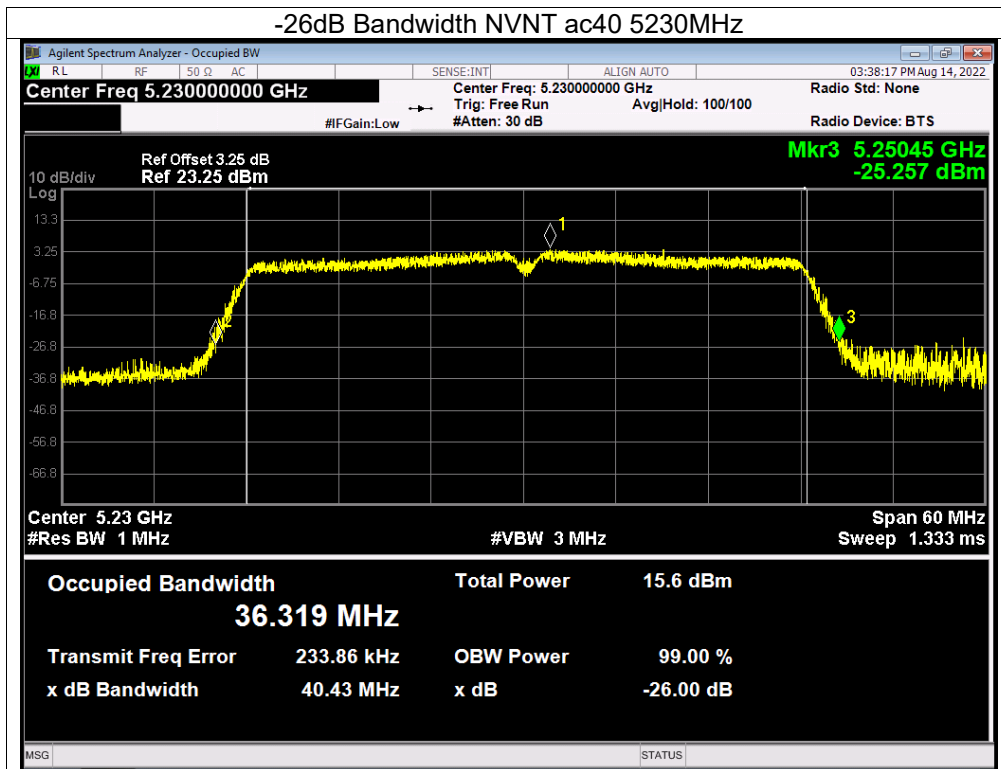

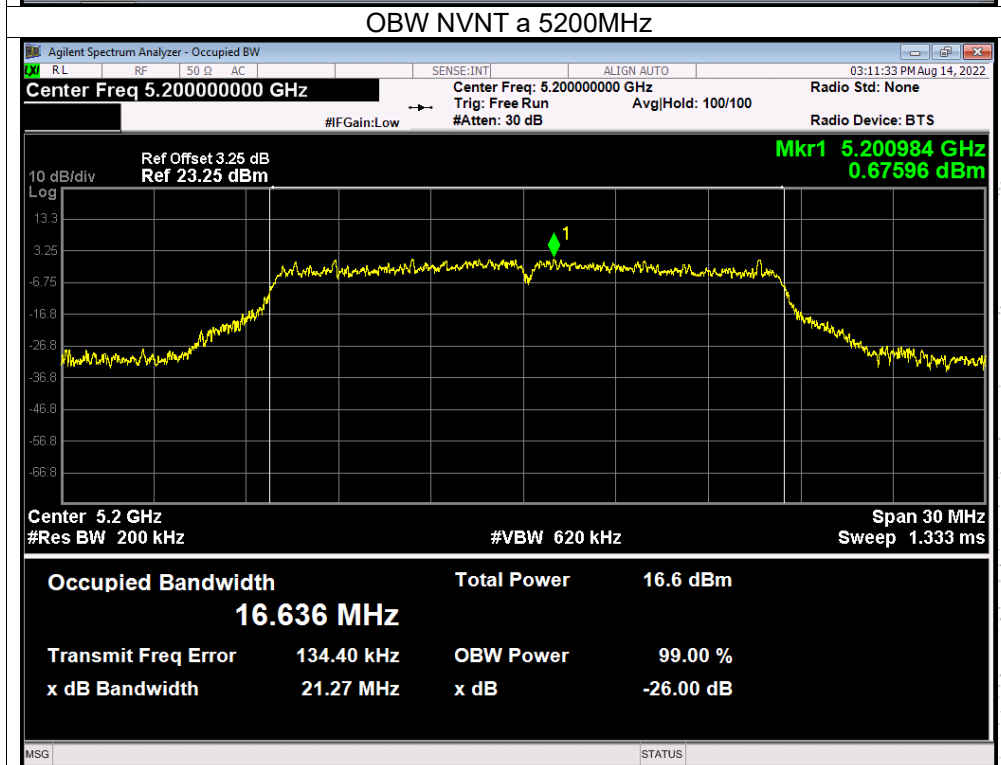
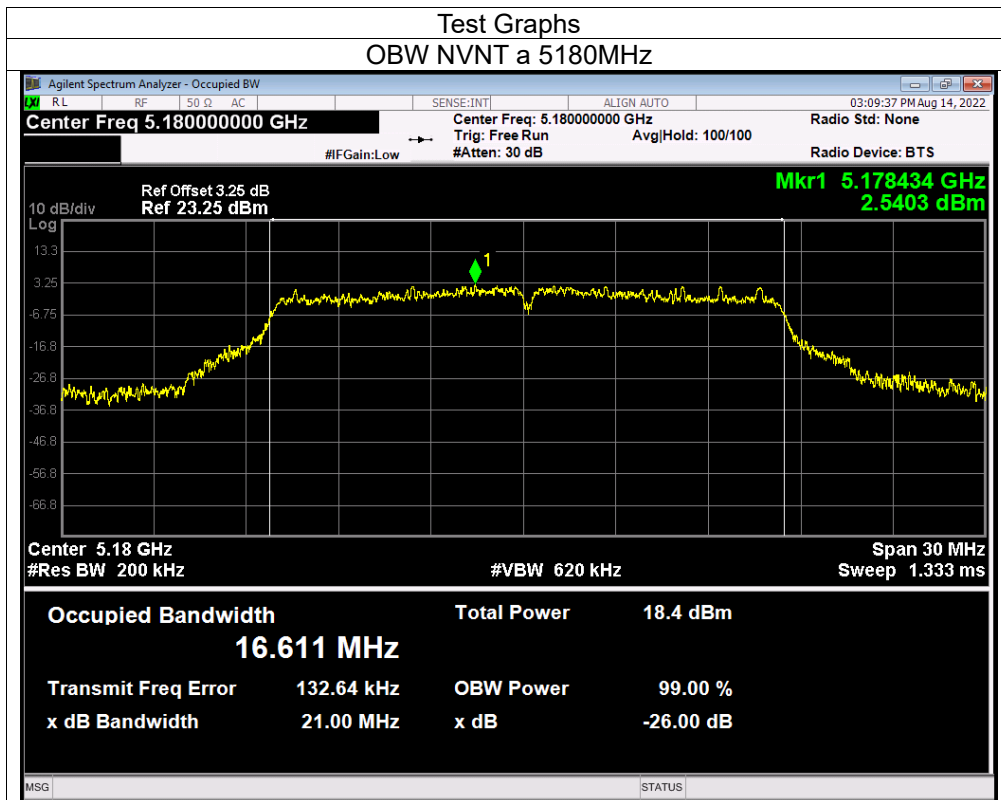

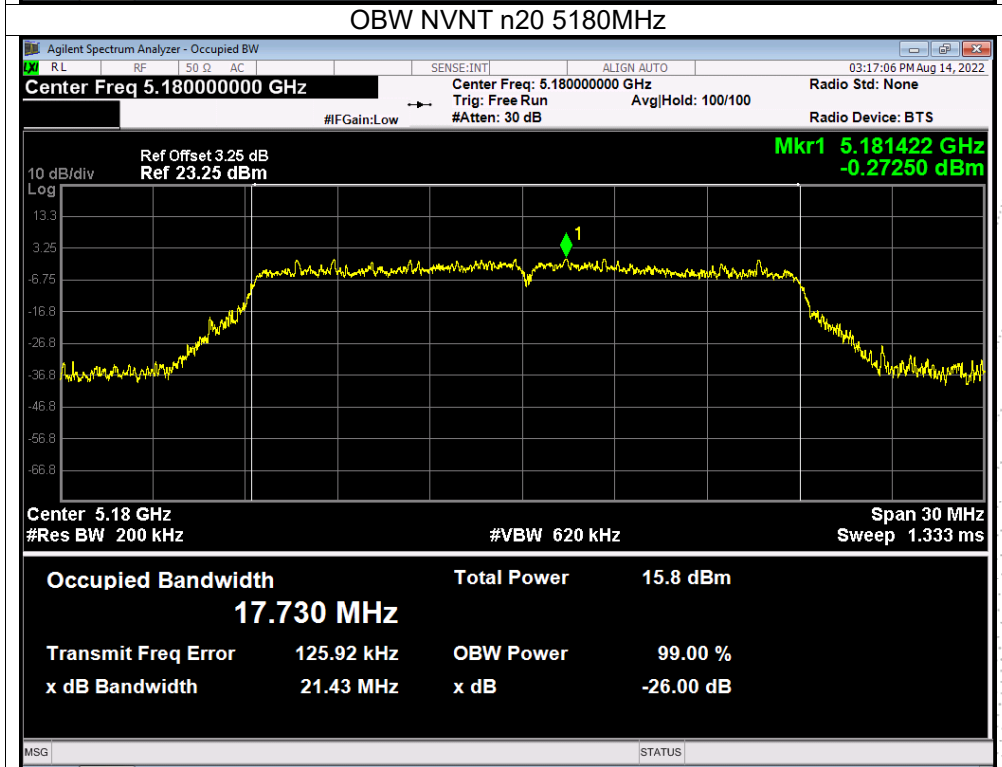
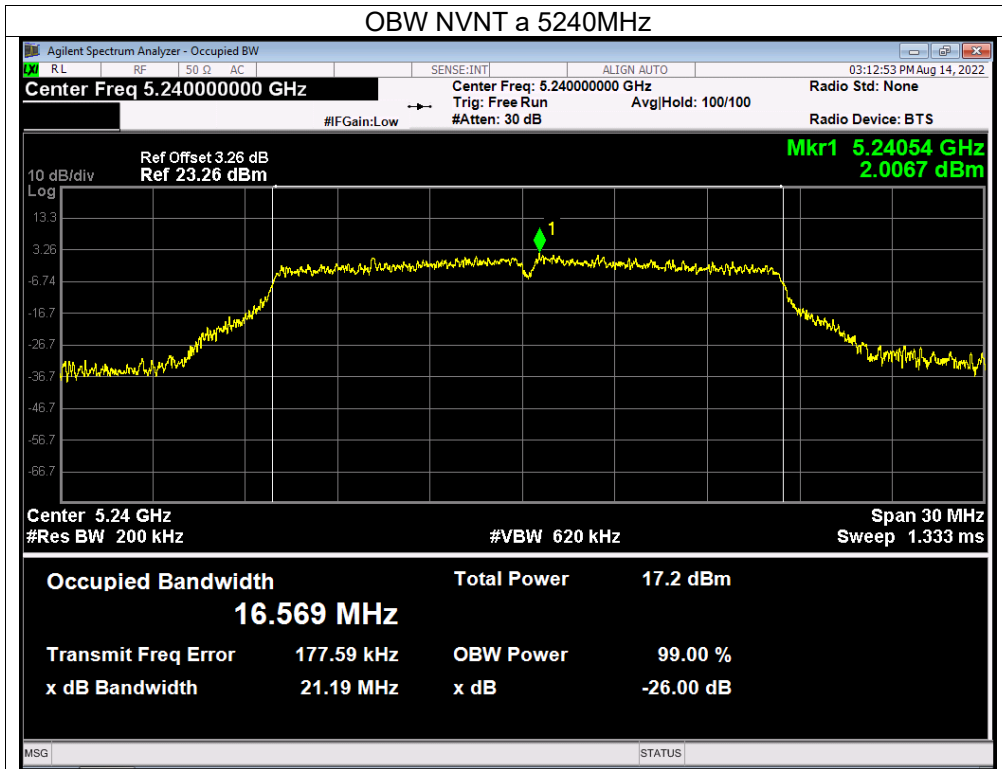

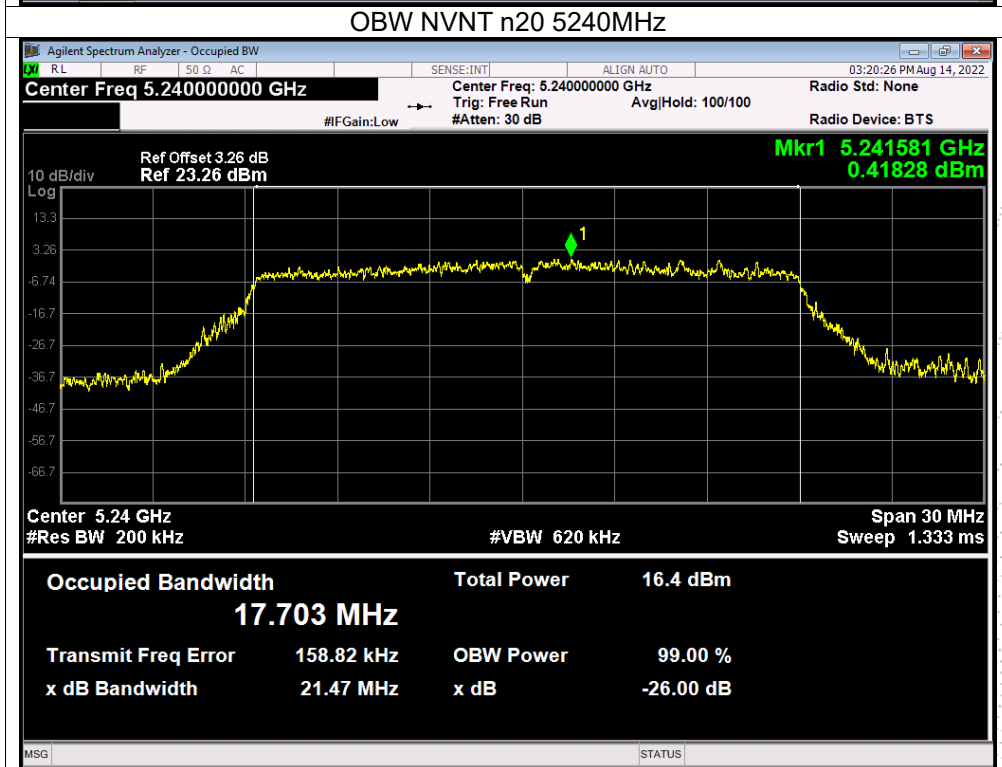
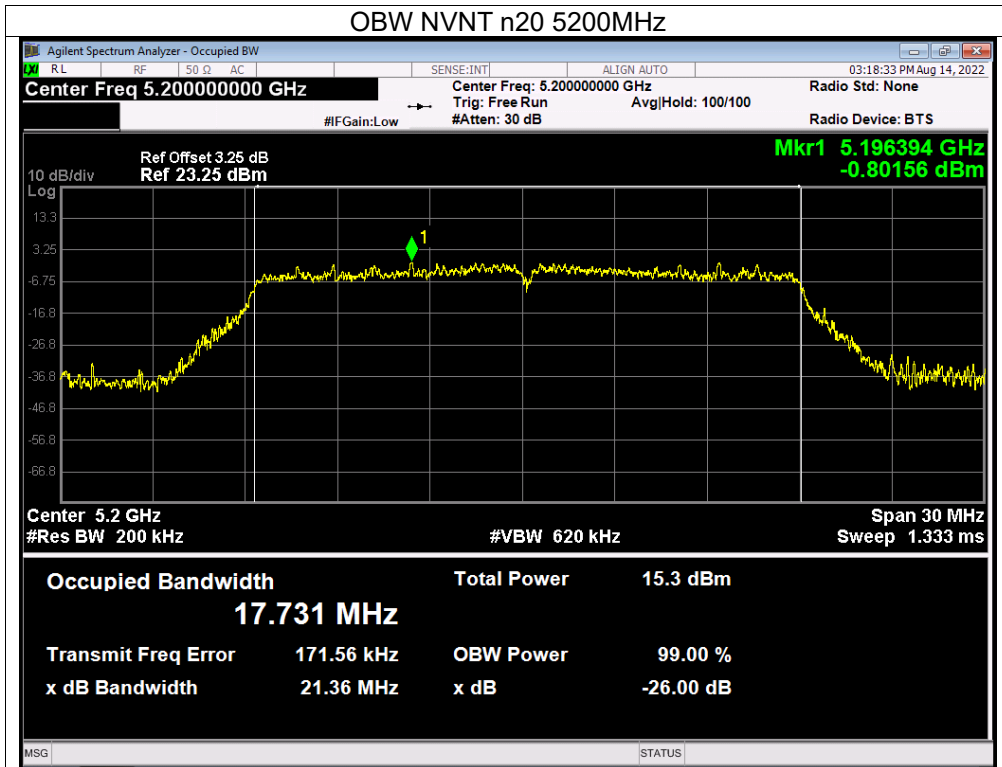

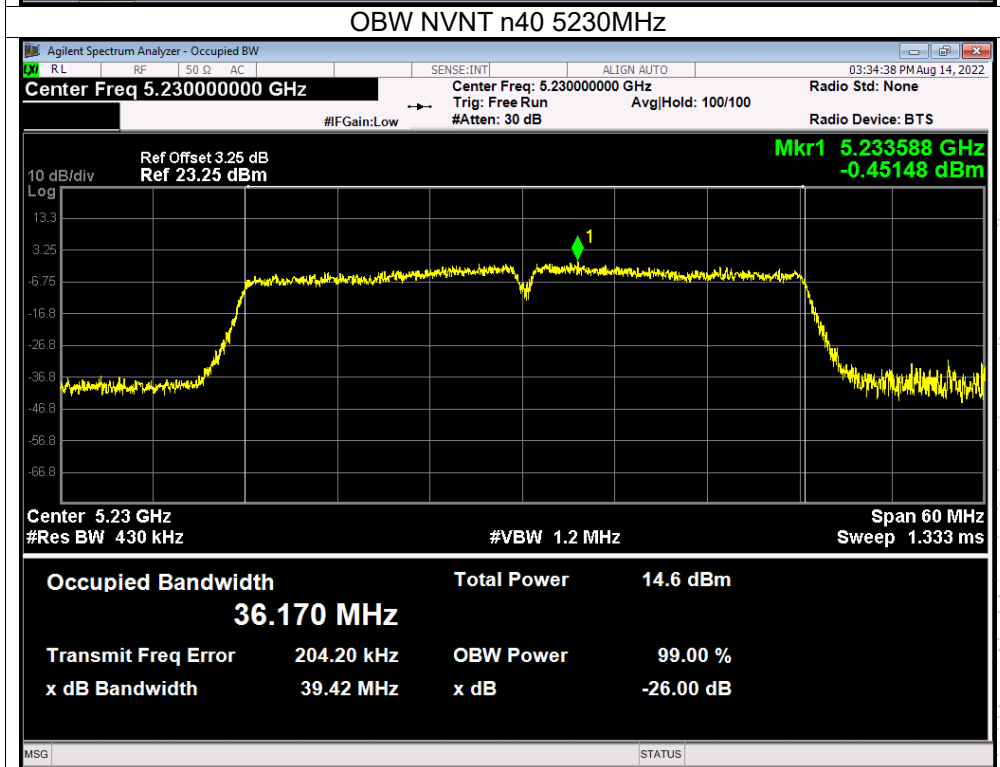
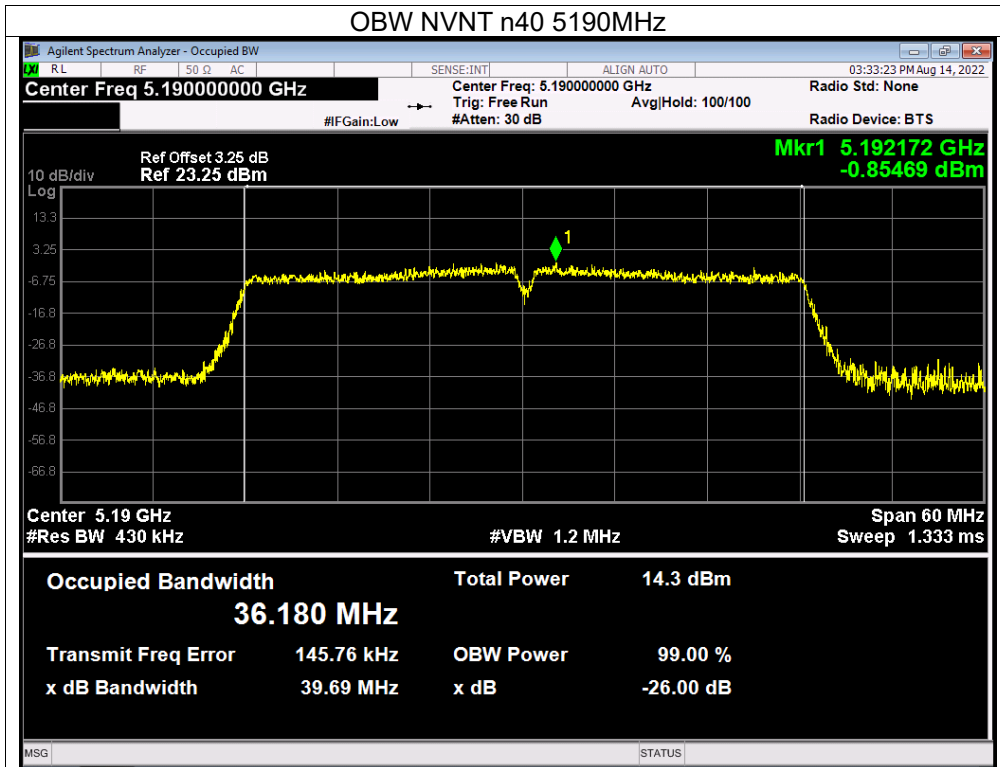

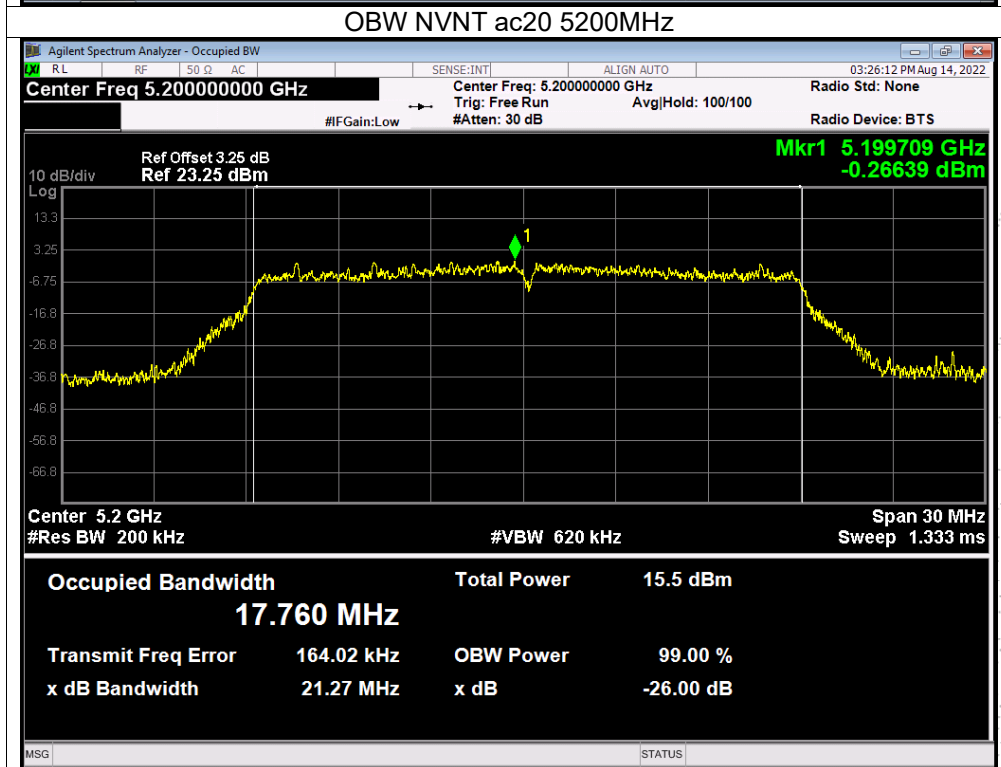
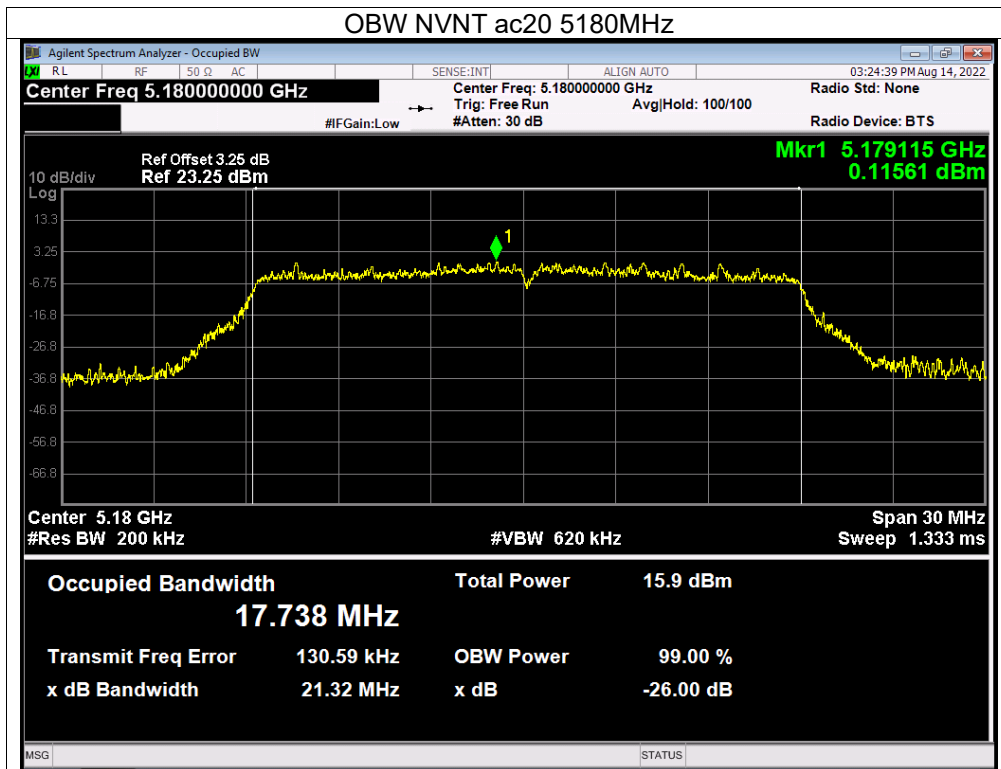

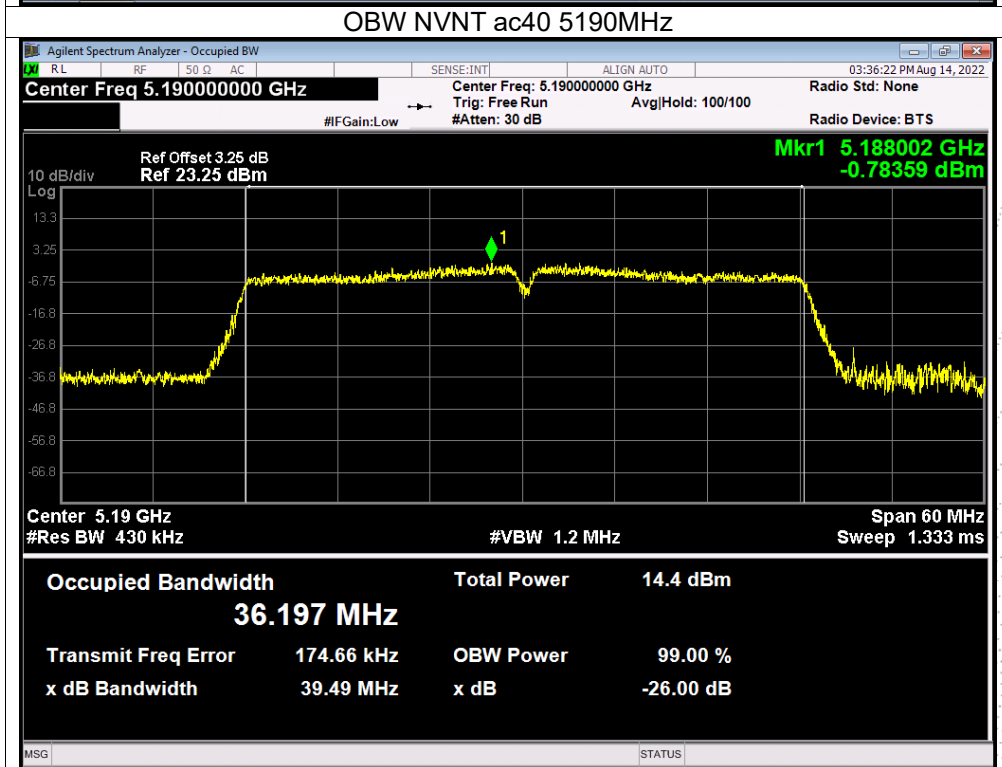
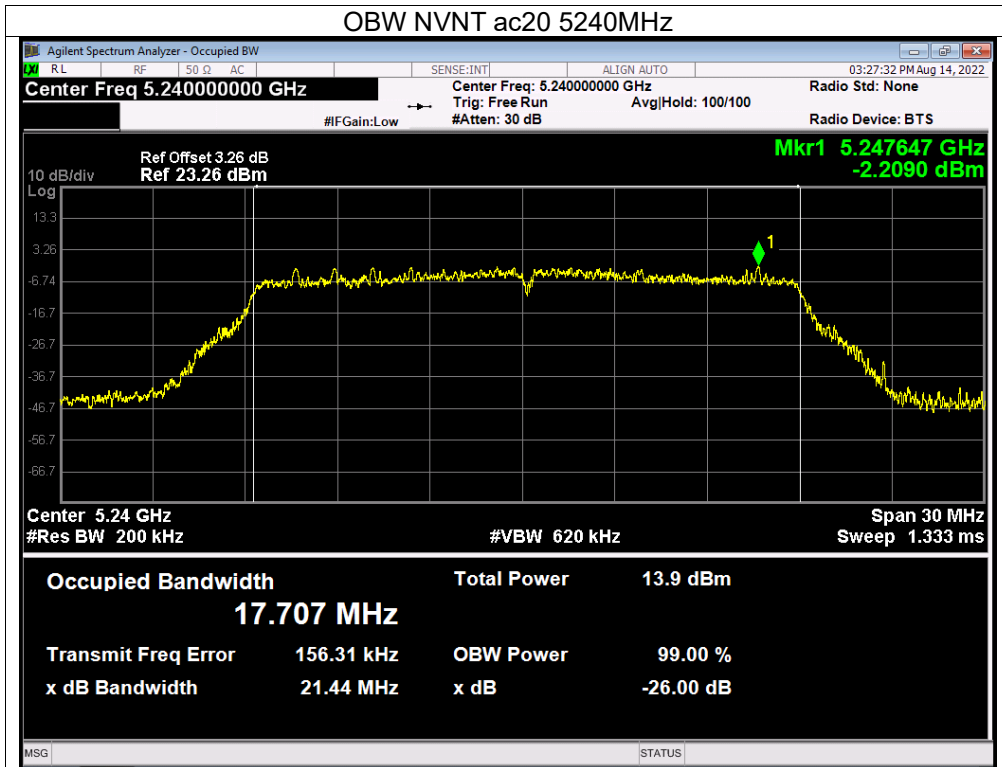

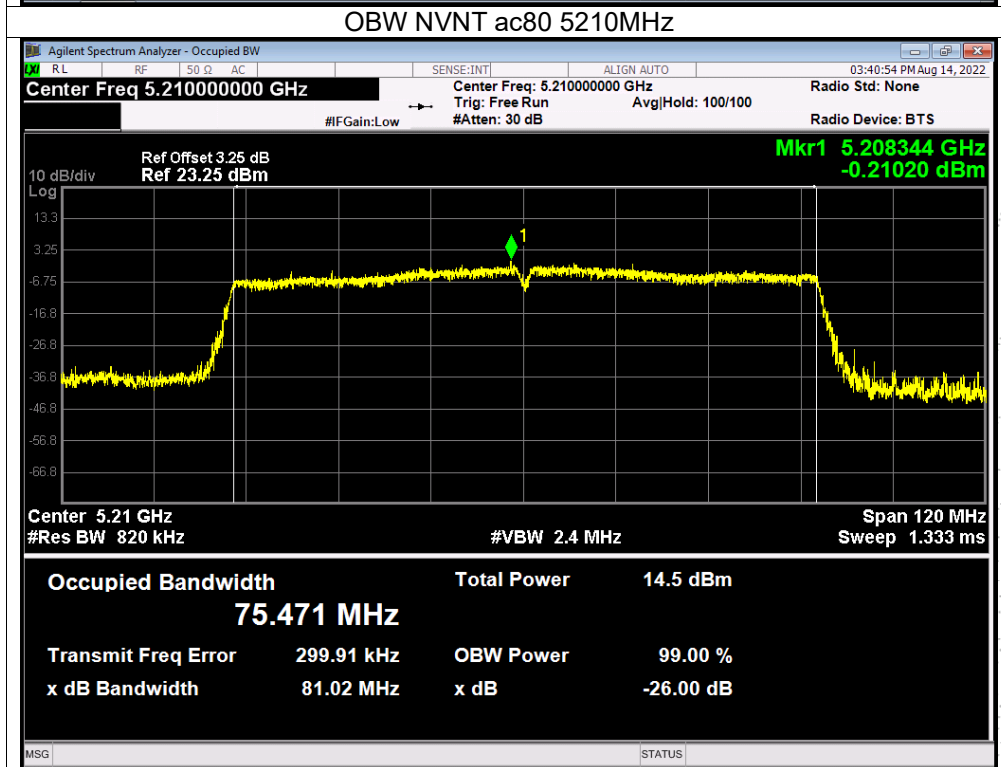
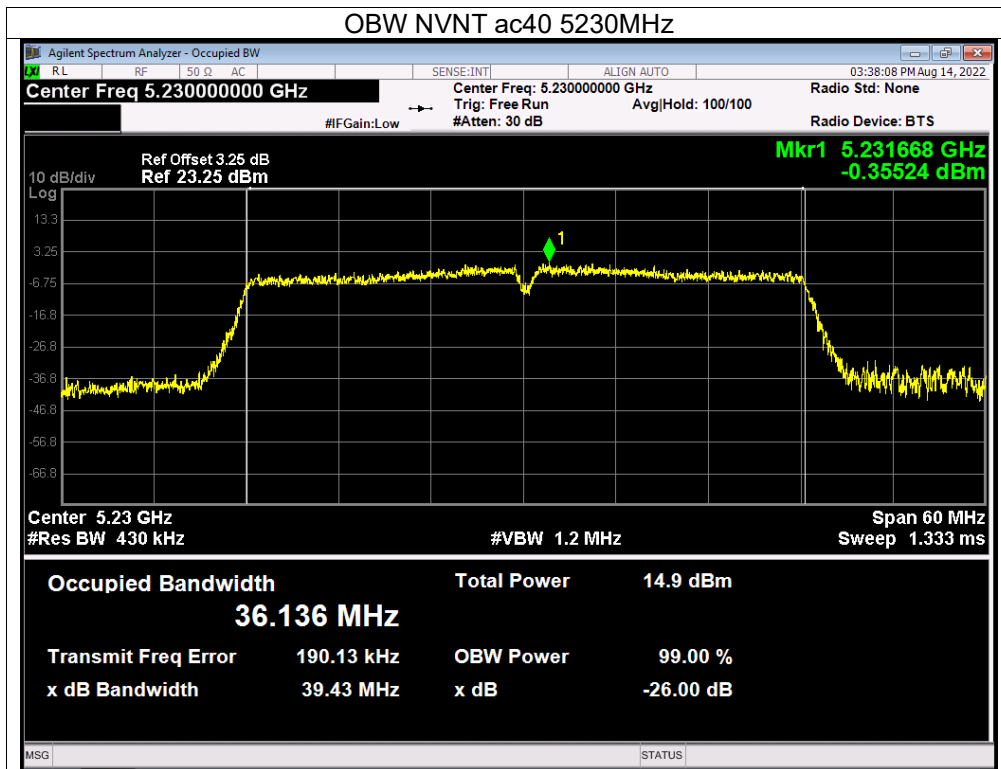

10. Maximum Conducted Output Power

10.1 Block Diagram Of Test Setup



10.2 Limit

According to FCC §15.407

The maximum conducted output power should not exceed:

Frequency Band(MHz)	Limit
5150~5250	250mW

10.3 Test procedure

Maximum conducted output power may be measured using a spectrum analyzer/EMI receiver or an RF power meter.

1. Device Configuration

If possible, configure or modify the operation of the EUT so that it transmits continuously at its maximum power control level (see section II.B.).

a) The intent is to test at 100 percent duty cycle; however a small reduction in duty cycle (to no lower than 98 percent) is permitted if required by the EUT for amplitude control purposes. Manufacturers are expected to provide software to the test lab to permit such continuous operation.

b) If continuous transmission (or at least 98 percent duty cycle) cannot be achieved due to hardware limitations (e.g., overheating), the EUT shall be operated at its maximum power control level with the transmit duration as long as possible and the duty cycle as high as possible.

2. Measurement using a Spectrum Analyzer or EMI Receiver (SA)

Measurement of maximum conducted output power using a spectrum analyzer requires integrating the spectrum across a frequency span that encompasses, at a minimum, either the EBW or the 99-percent occupied bandwidth of the signal.¹ However, the EBW must be used to determine bandwidth dependent limits on maximum conducted output power in accordance with § 15.407(a).

a) The test method shall be selected as follows: (i) Method SA-1 or SA-1 Alternative (averaging with the EUT transmitting at full power throughout each sweep) shall be applied if either of the following conditions can be satisfied:

- The EUT transmits continuously (or with a duty cycle \geq 98 percent).
- Sweep triggering or gating can be implemented in a way that the device transmits at the maximum power control level throughout the duration of each of the instrument sweeps to be averaged. This condition can generally be achieved by triggering the instrument's sweep if the duration of the sweep (with the analyzer configured as in Method SA-1, below) is equal to or shorter than the duration T of each transmission from the EUT and if those transmissions exhibit full power throughout their durations.

(ii) Method SA-2 or SA-2 Alternative (averaging across on and off times of the EUT transmissions, followed by duty cycle correction) shall be applied if the conditions of (i) cannot be achieved and the transmissions exhibit a constant duty cycle during the measurement duration. Duty cycle will be considered

to be constant if variations are less than ± 2 percent.

(iii) Method SA-3 (RMS detection with max hold) or SA-3 Alternative (reduced VBW with max hold) shall be applied if the conditions of (i) and (ii) cannot be achieved.

b) Method SA-1 (trace averaging with the EUT transmitting at full power throughout each sweep): (i) Set span to encompass the entire emission bandwidth (EBW) (or, alternatively, the entire 99% occupied bandwidth) of the signal.

(ii) Set RBW = 1 MHz.

(iii) Set VBW ≥ 3 MHz.

(iv) Number of points in sweep ≥ 2 Span / RBW. (This ensures that bin-to-bin spacing is \leq RBW/2, so that narrowband signals are not lost between frequency bins.)

(v) Sweep time = auto.

(vi) Detector = RMS (i.e., power averaging), if available. Otherwise, use sample detector mode.

(vii) If transmit duty cycle < 98 percent, use a video trigger with the trigger level set to enable triggering only on full power pulses. Transmitter must operate at maximum power control level for the entire duration of every sweep. If the EUT transmits continuously (i.e., with no off intervals) or at duty cycle ≥ 98 percent, and if each transmission is entirely at the maximum power control level, then the trigger shall be set to "free run".

(viii) Trace average at least 100 traces in power averaging (i.e., RMS) mode.

(ix) Compute power by integrating the spectrum across the EBW (or, alternatively, the entire 99% occupied bandwidth) of the signal using the instrument's band power measurement function with band limits set equal to the EBW (or occupied bandwidth) band edges. If the instrument does not have a band power function, sum the spectrum

10.4 EUT operating Conditions

The EUT was configured for testing in a typical fashion (as a customer would normally use it). The EUT has been programmed to continuously transmit during test. This operating condition was tested and used to collect the included data.

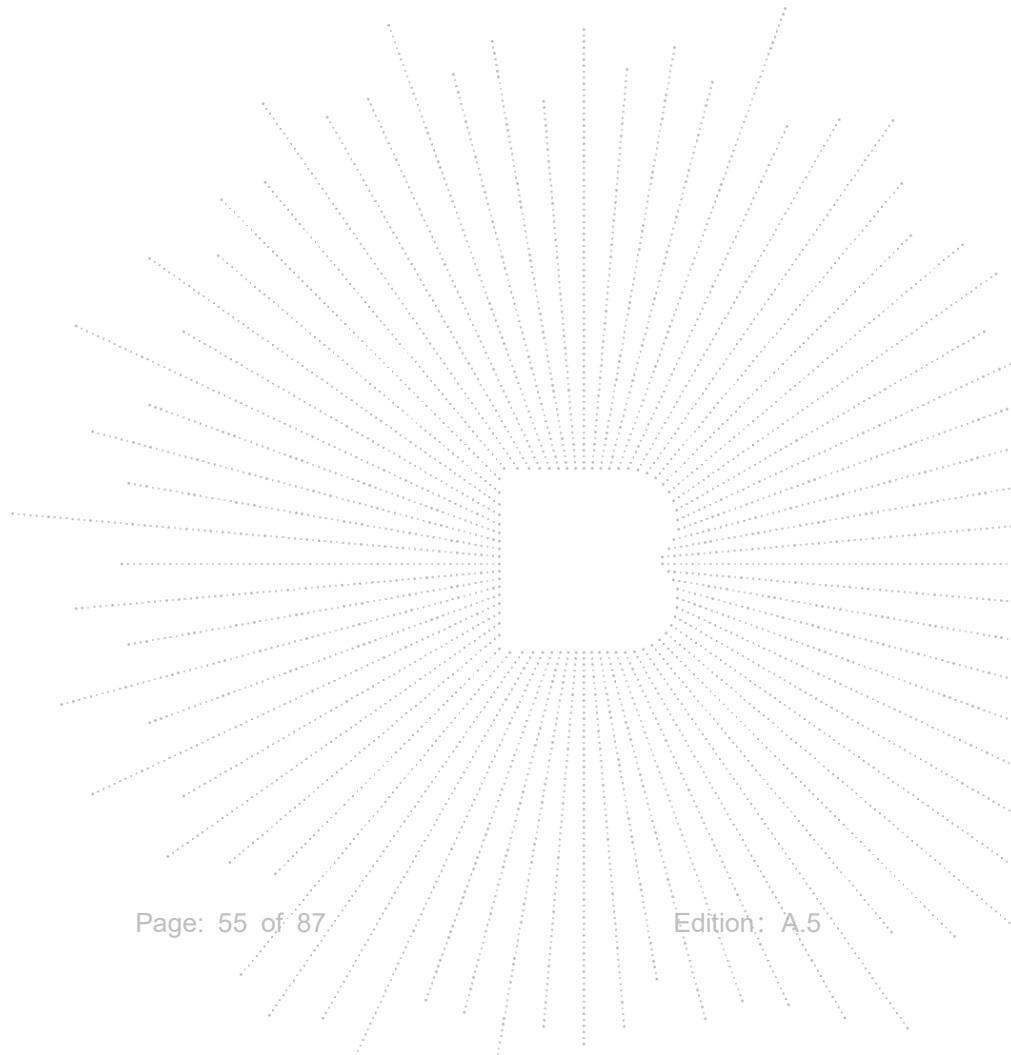

10.5 Test Result

Temperature:	26 °C	Relative Humidity:	54%
Pressure:	101KPa	Test Voltage:	DC 5V
Test Mode:	(5180-5240MHz)		

Condition	Mode	Frequency (MHz)	Conducted Power (dBm)	Limit (dBm)	Verdict
NVNT	a	5180	12.50	24	Pass
NVNT	a	5200	10.84	24	Pass
NVNT	a	5240	11.54	24	Pass
NVNT	n20	5180	9.85	24	Pass
NVNT	n20	5200	9.35	24	Pass
NVNT	n20	5240	10.44	24	Pass
NVNT	n40	5190	8.37	24	Pass
NVNT	n40	5230	8.63	24	Pass
NVNT	ac20	5180	9.96	24	Pass
NVNT	ac20	5200	9.53	24	Pass
NVNT	ac20	5240	7.98	24	Pass
NVNT	ac40	5190	8.37	24	Pass
NVNT	ac40	5230	8.91	24	Pass
NVNT	ac80	5210	7.61	24	Pass

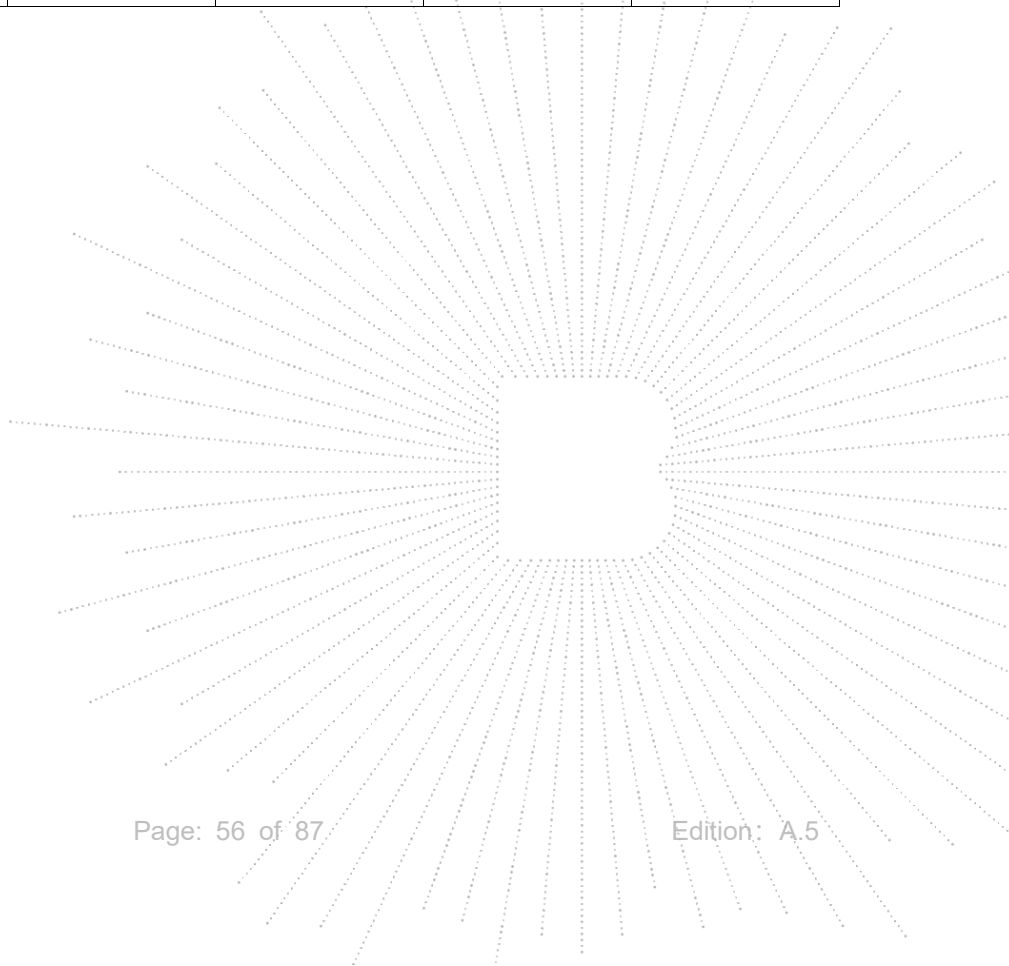

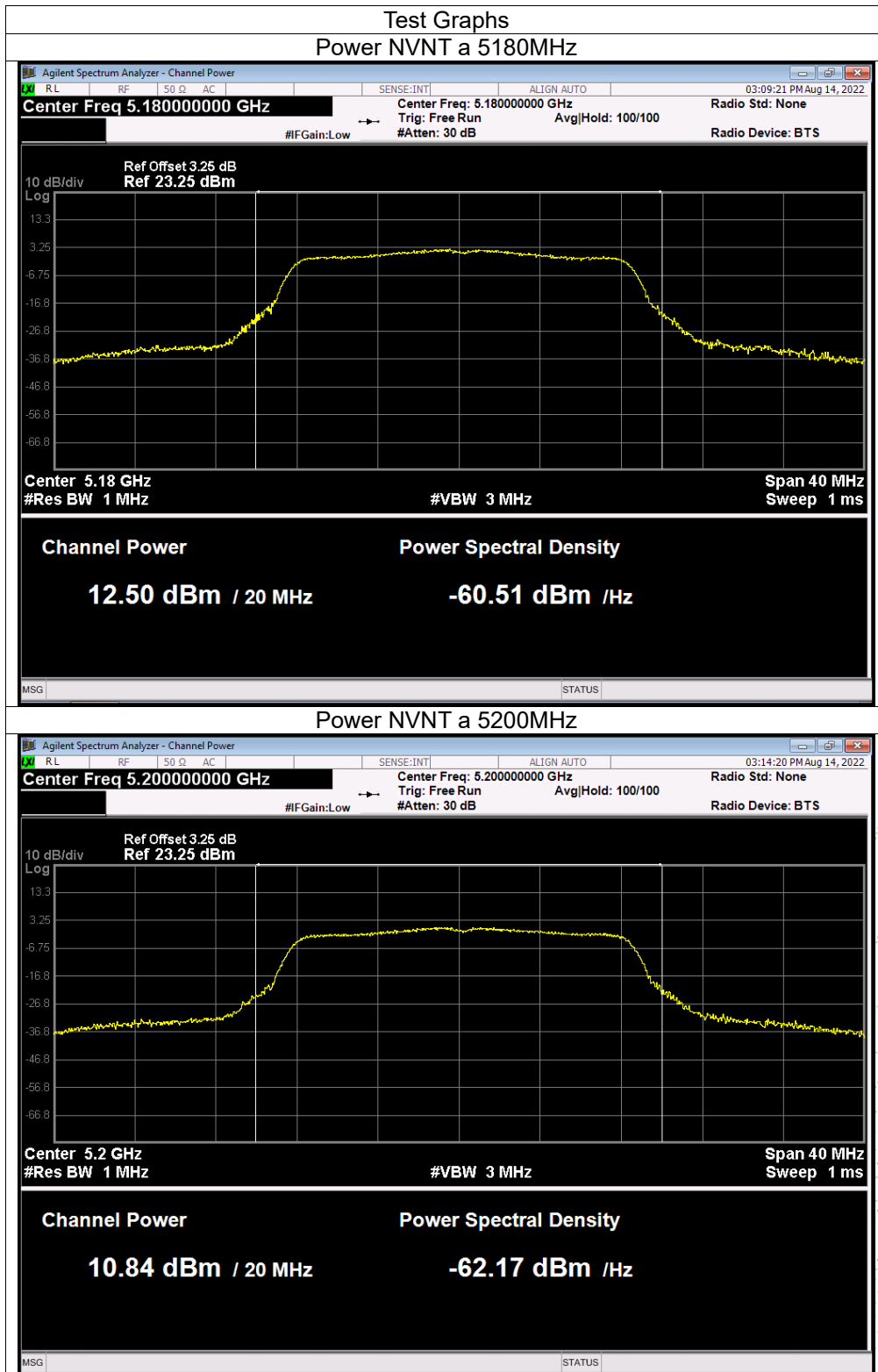

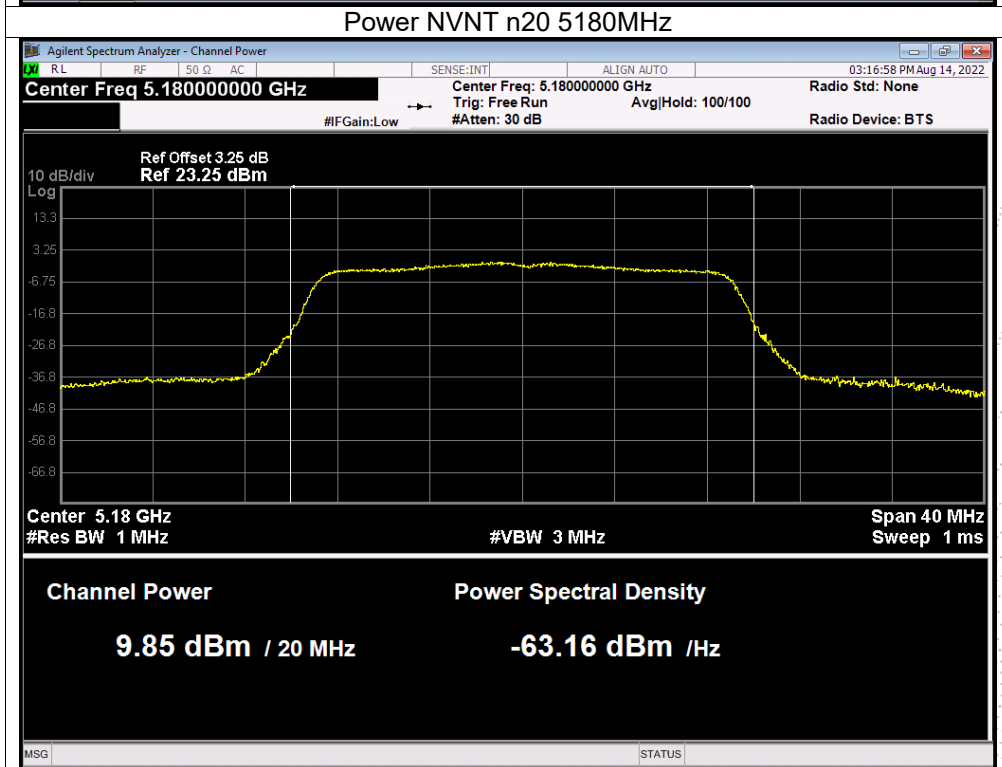
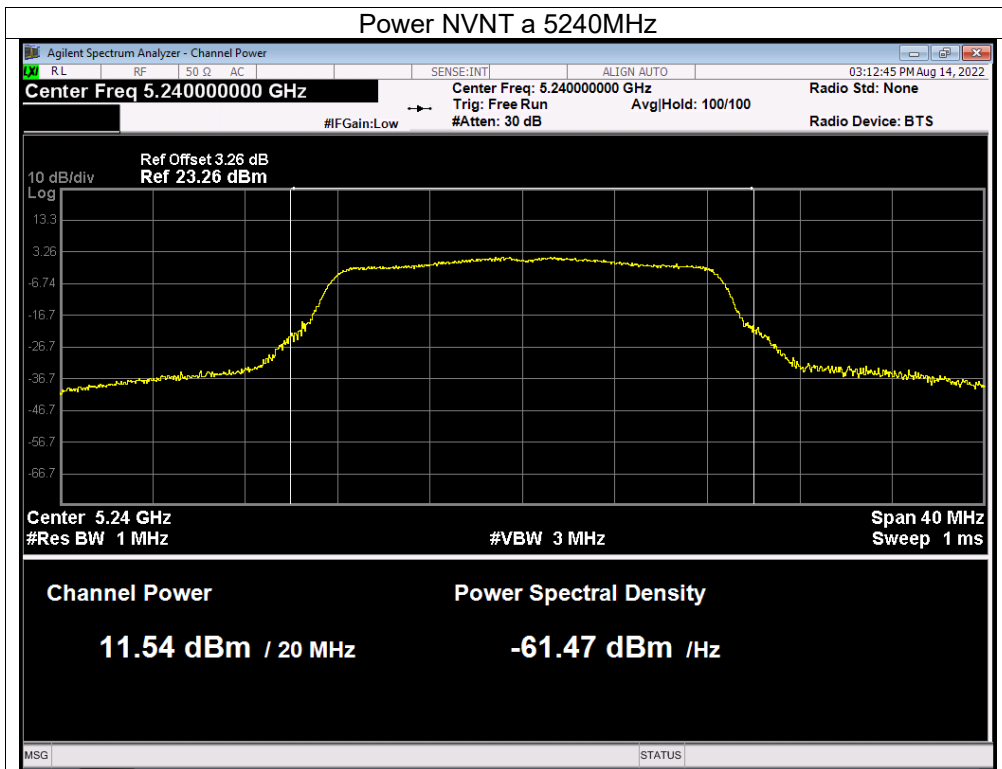

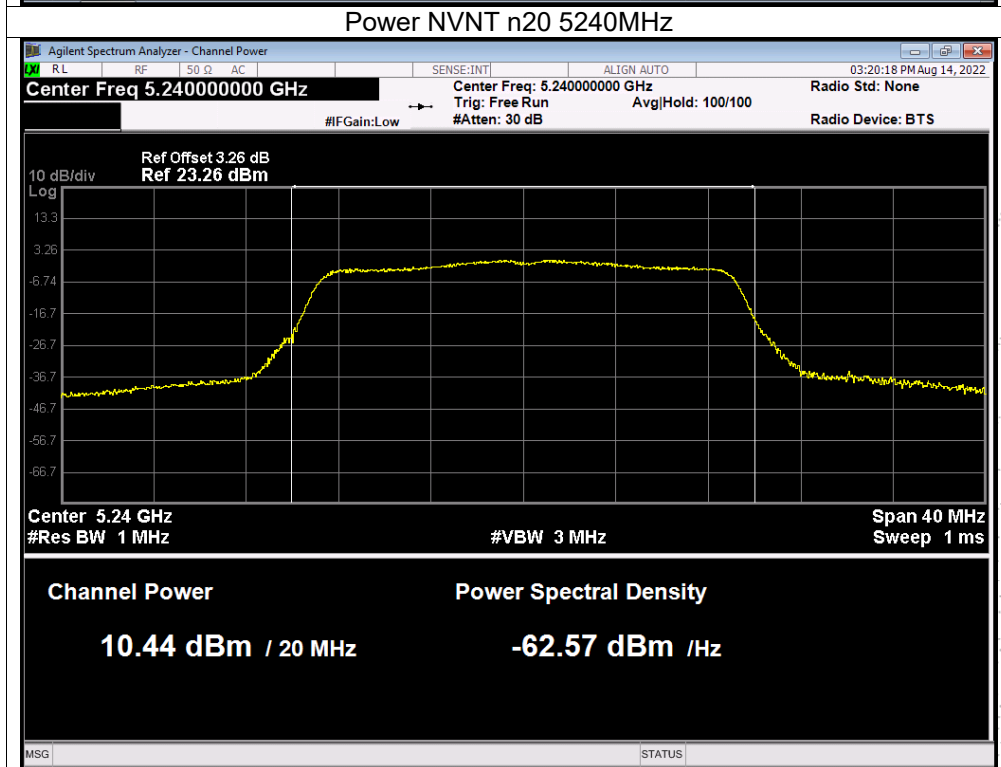
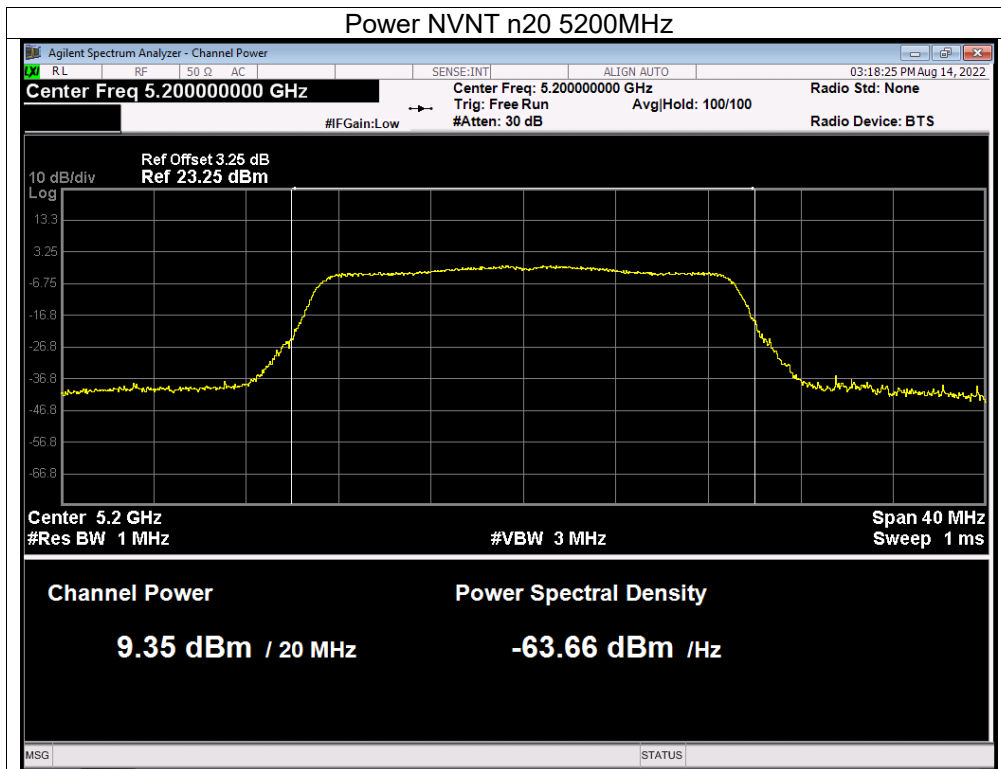

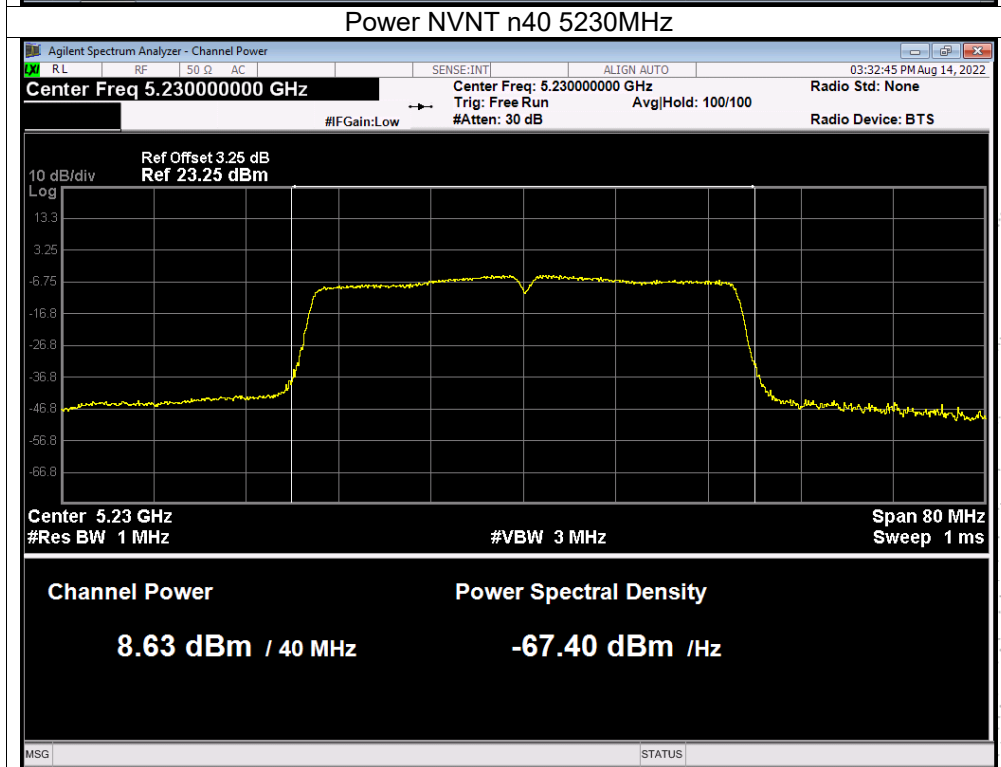
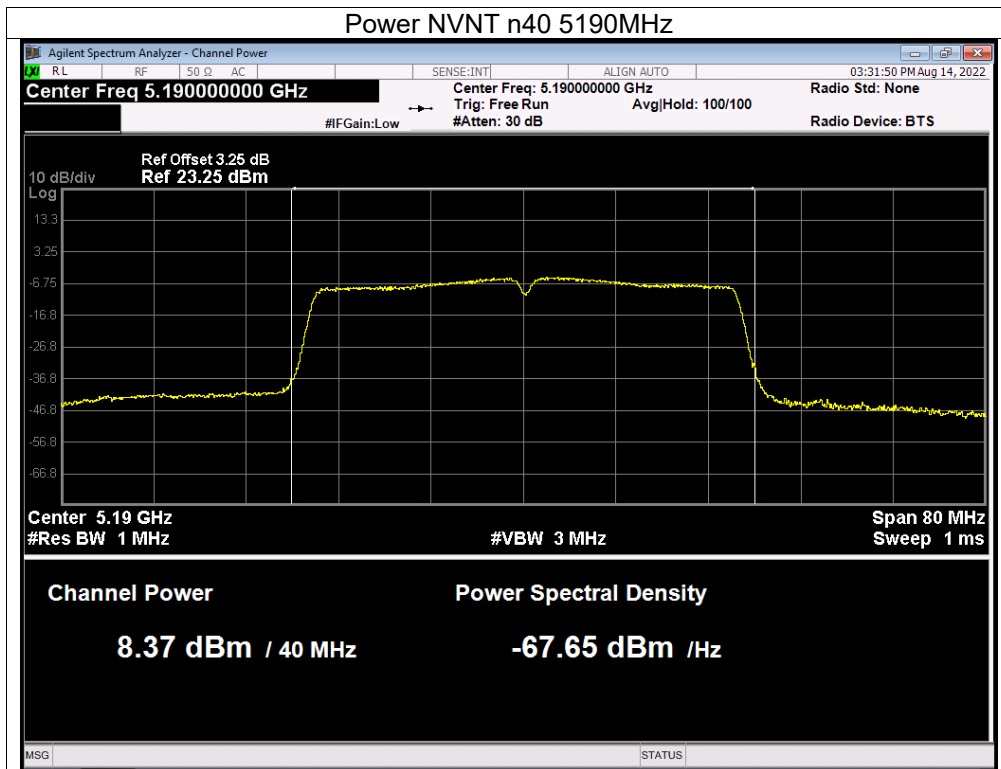

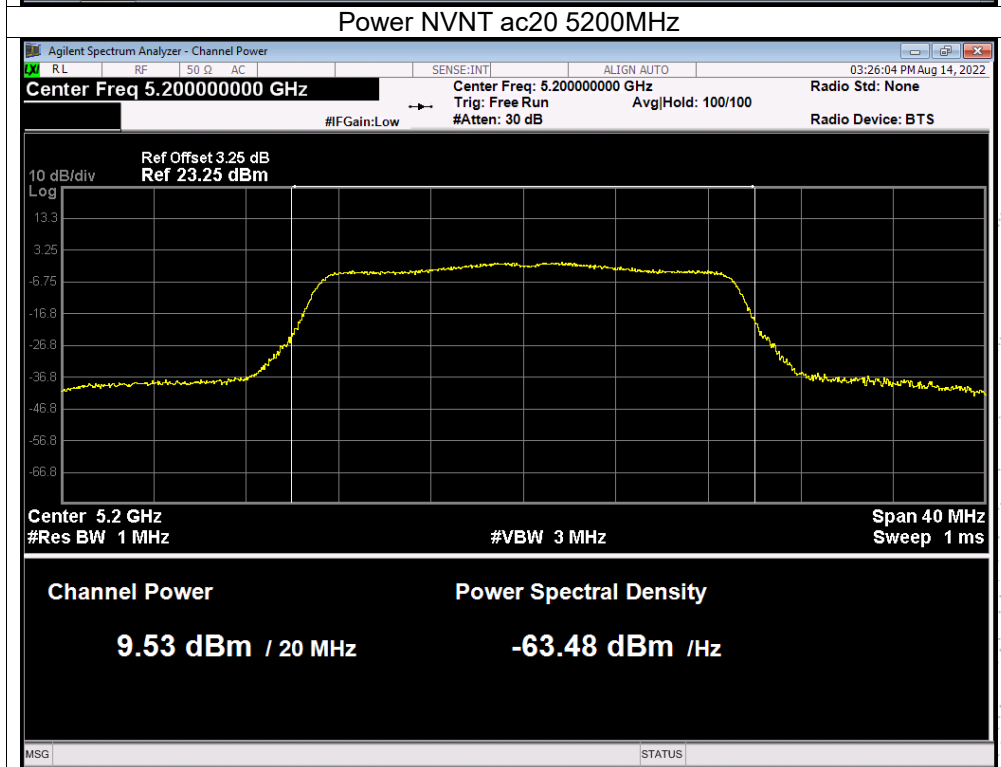
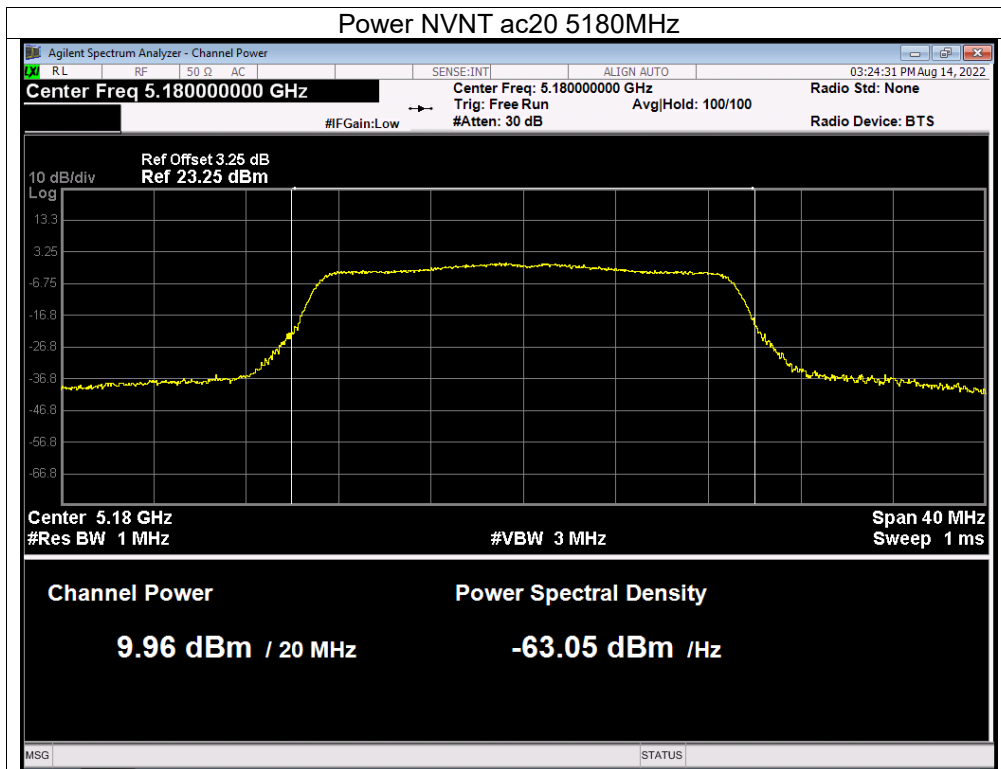

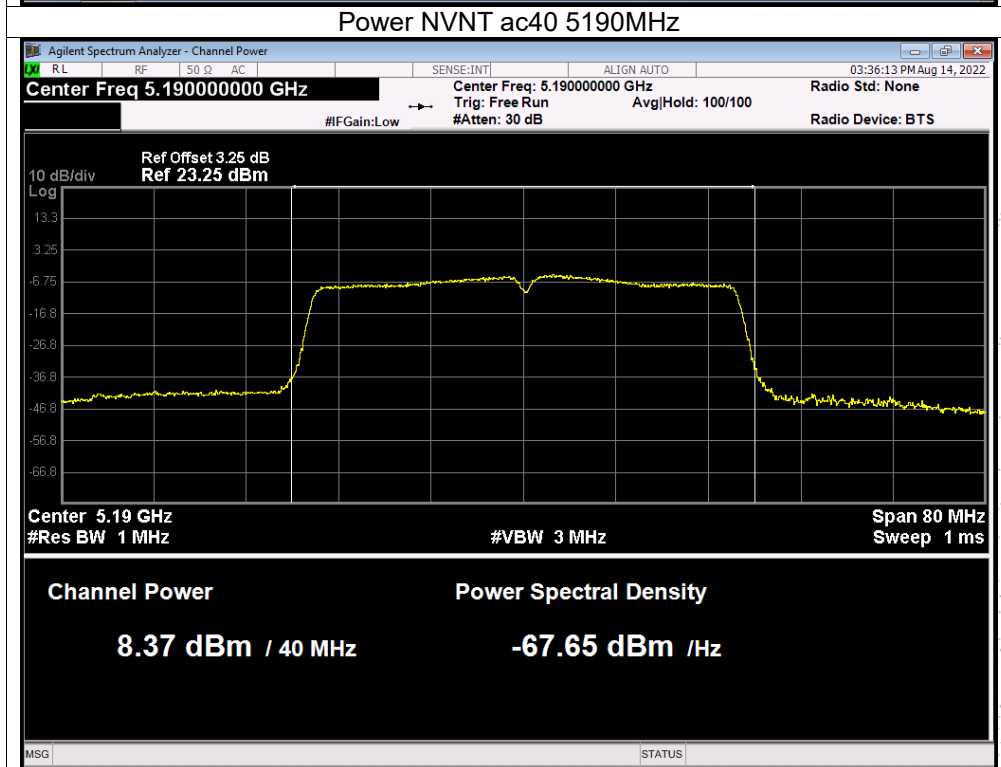
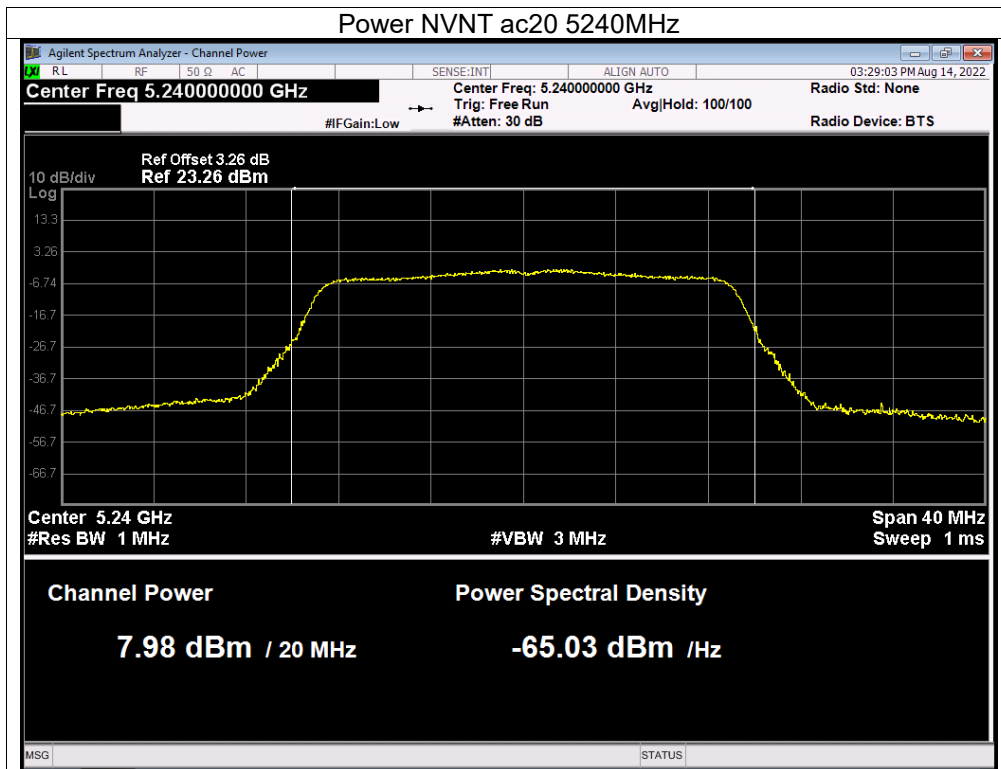

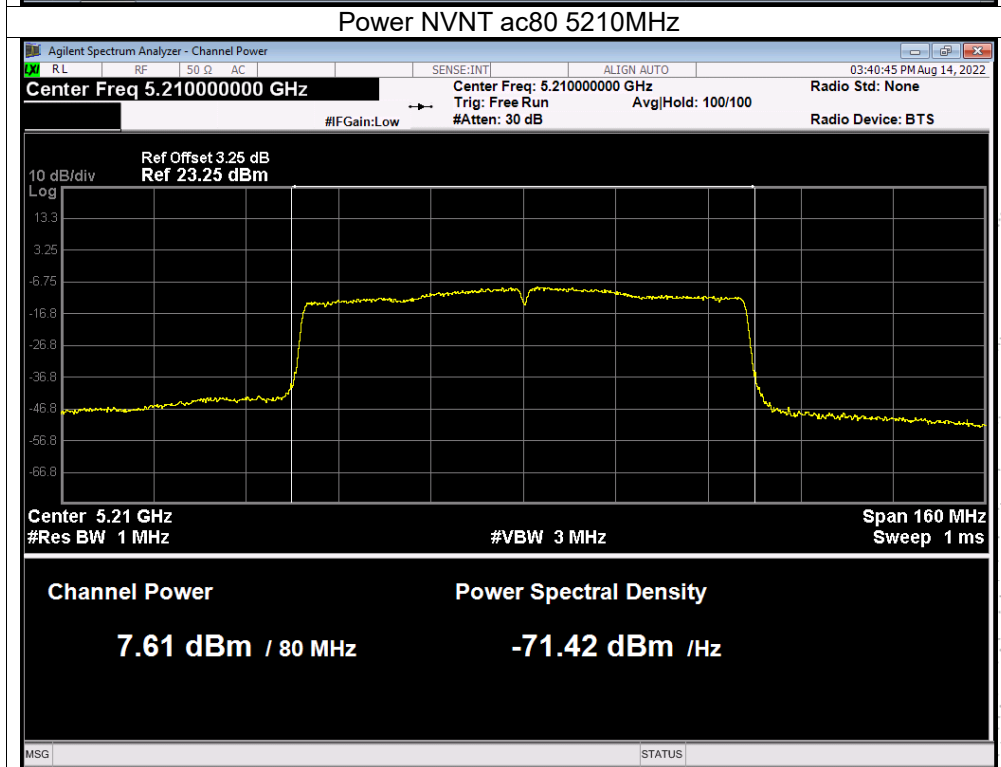
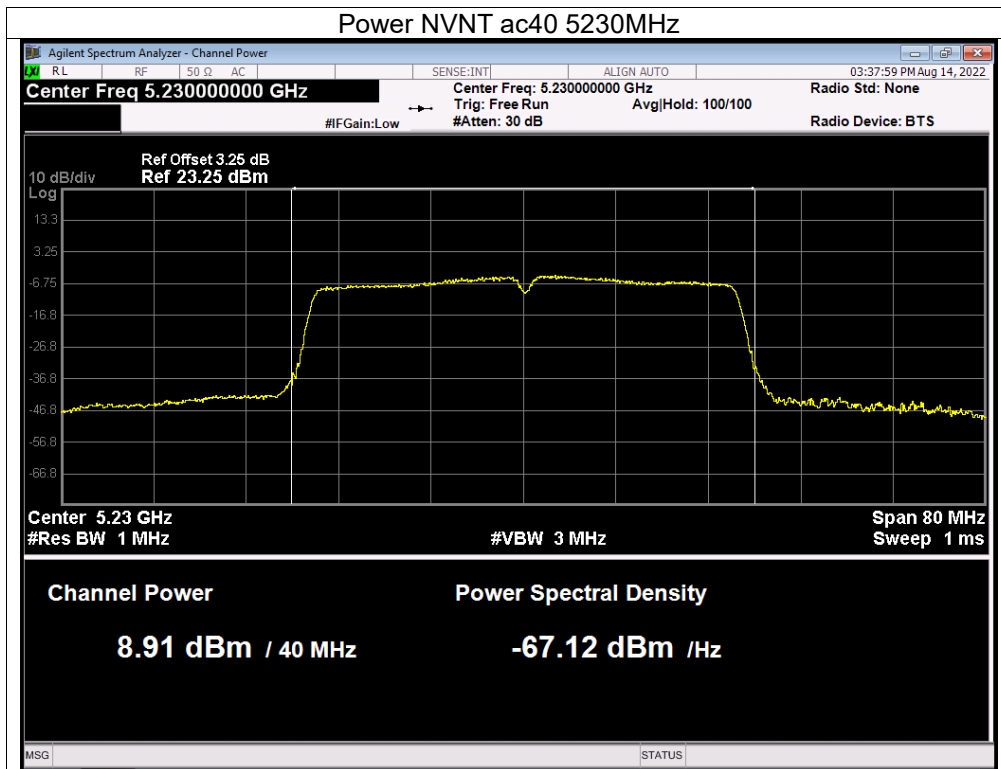

11. Out Of Band Emissions

11.1 Block Diagram Of Test Setup

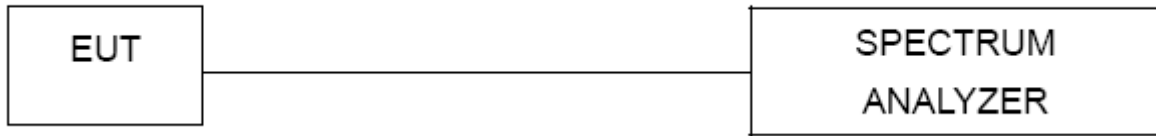

11.2 Limit

According to FCC §15.407(b)

Undesirable emission limits. Except as shown in paragraph (b)(7) of this section, the maximum emissions outside of the frequency bands of operation shall be attenuated in accordance with the following limits:

(1) For transmitters operating in the 5.15-5.25 GHz band: All emissions outside of the 5.15-5.35 GHz band shall not exceed an e.i.r.p. of -27 dBm/MHz.

(2) All emissions shall be limited to a level of -27 dBm/MHz at 75 MHz or more above or below the band edge increasing linearly to 10 dBm/MHz at 25 MHz above or below the band edge, and from 25 MHz above or below the band edge increasing linearly to a level of 15.6 dBm/MHz at 5 MHz above or below the band edge, and from 5 MHz above or below the band edge increasing linearly to a level of 27 dBm/MHz at the band edge.

11.3 Test procedure

1. Check the calibration of the measuring instrument using either an internal calibrator or a known signal from an external generator.
2. Position the EUT without connection to measurement instrument. Turn on the EUT and connect its antenna terminal to measurement instrument via a low loss cable. Then set it to any one measured frequency within its operating range, and make sure the instrument is operated in its linear range.
3. Set RBW of spectrum analyzer to 1 MHz with a convenient frequency span.
4. Measure the highest amplitude appearing on spectral display and set it as a reference level. Plot the graph with marking the highest point and edge frequency.
5. Repeat above procedures until all measured frequencies were complete.

11.4 EUT operating Conditions

The EUT was configured for testing in a typical fashion (as a customer would normally use it). The EUT has been programmed to continuously transmit during test. This operating condition was tested and used to collect the included data

11.5 Test Result

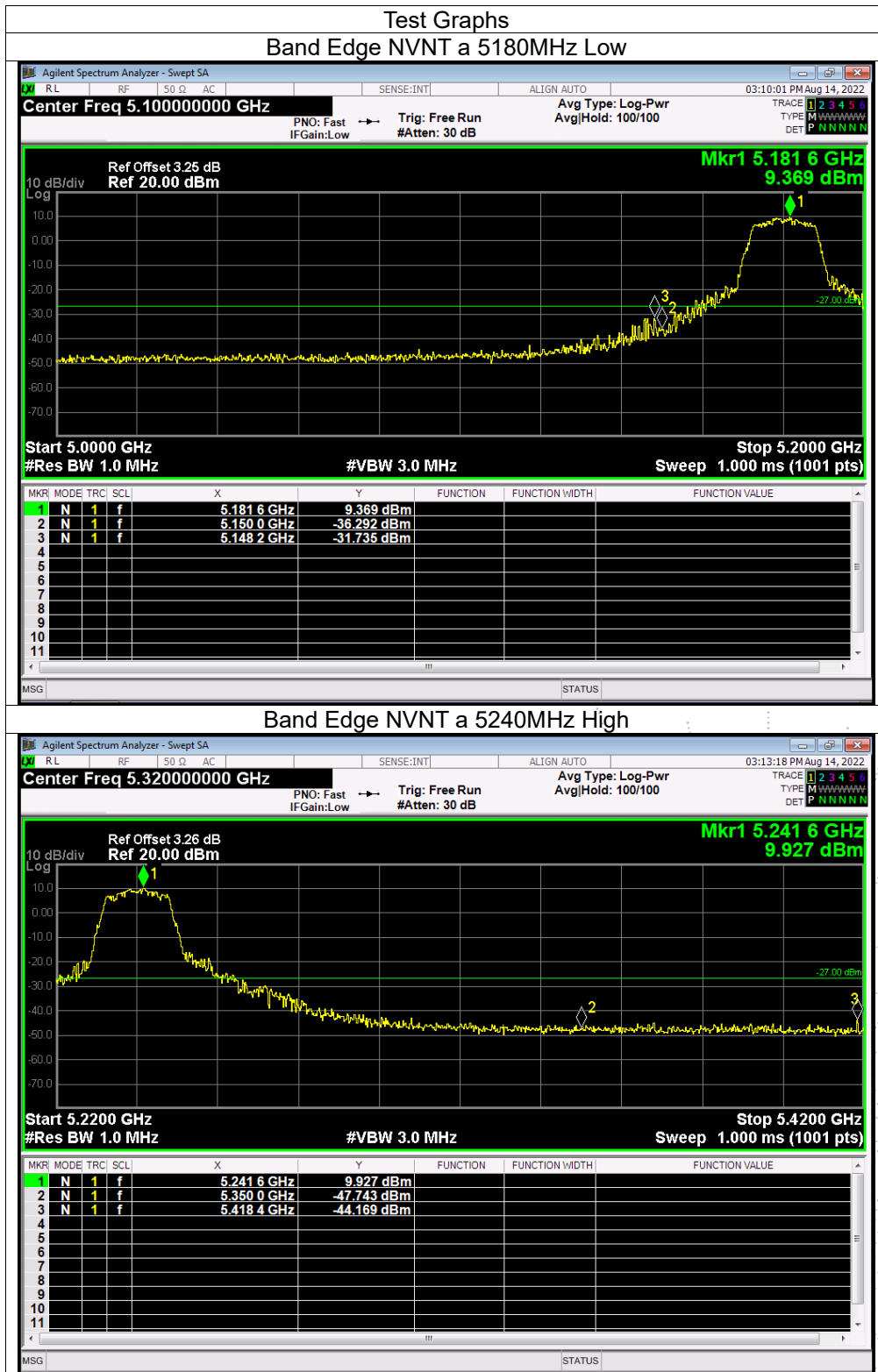

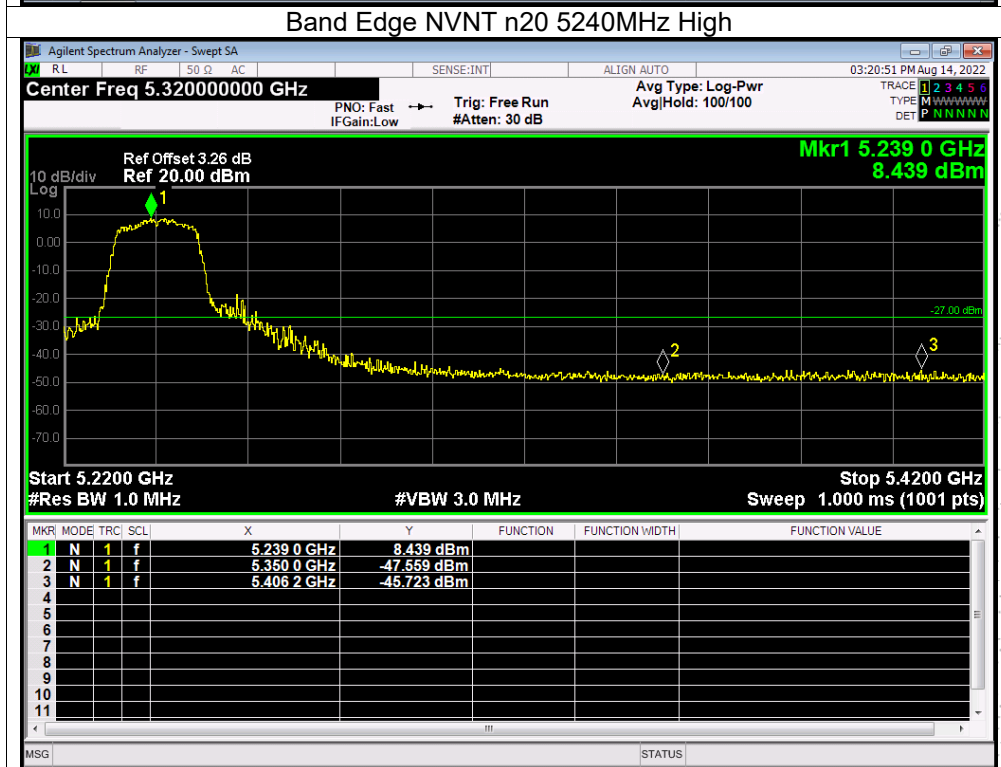
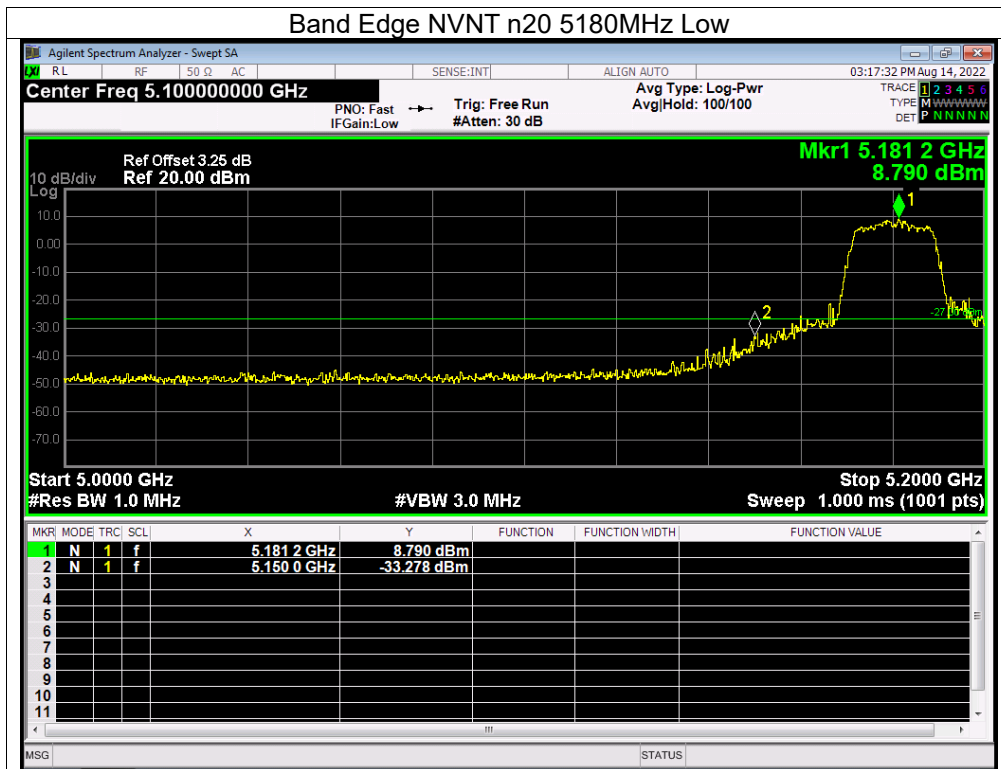

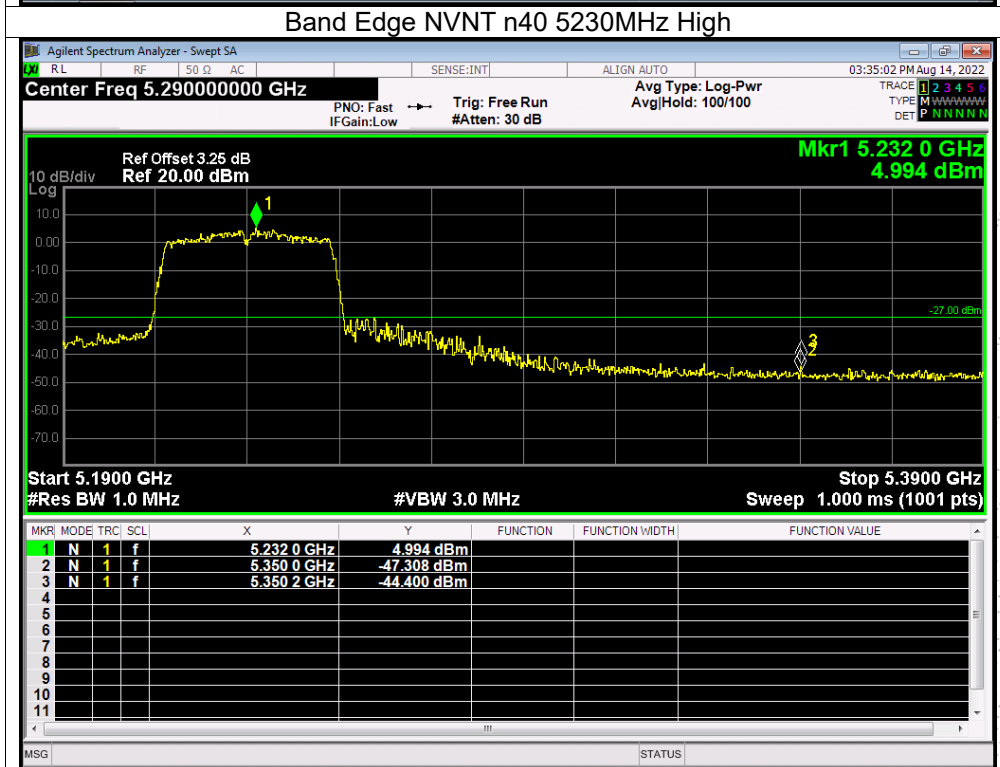
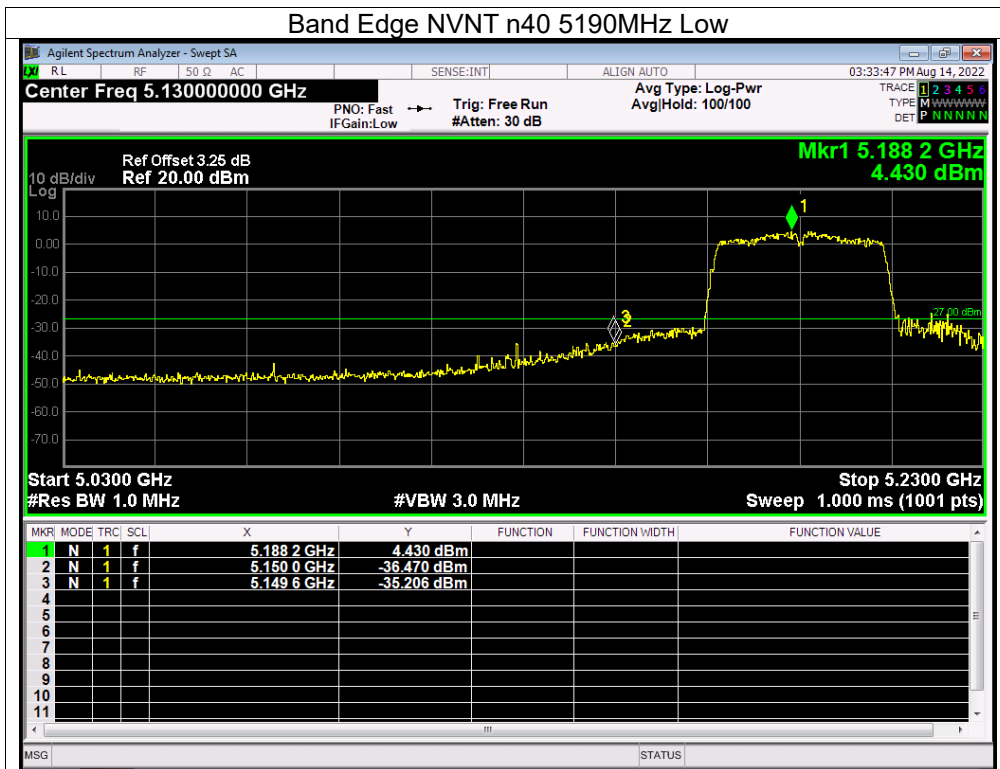

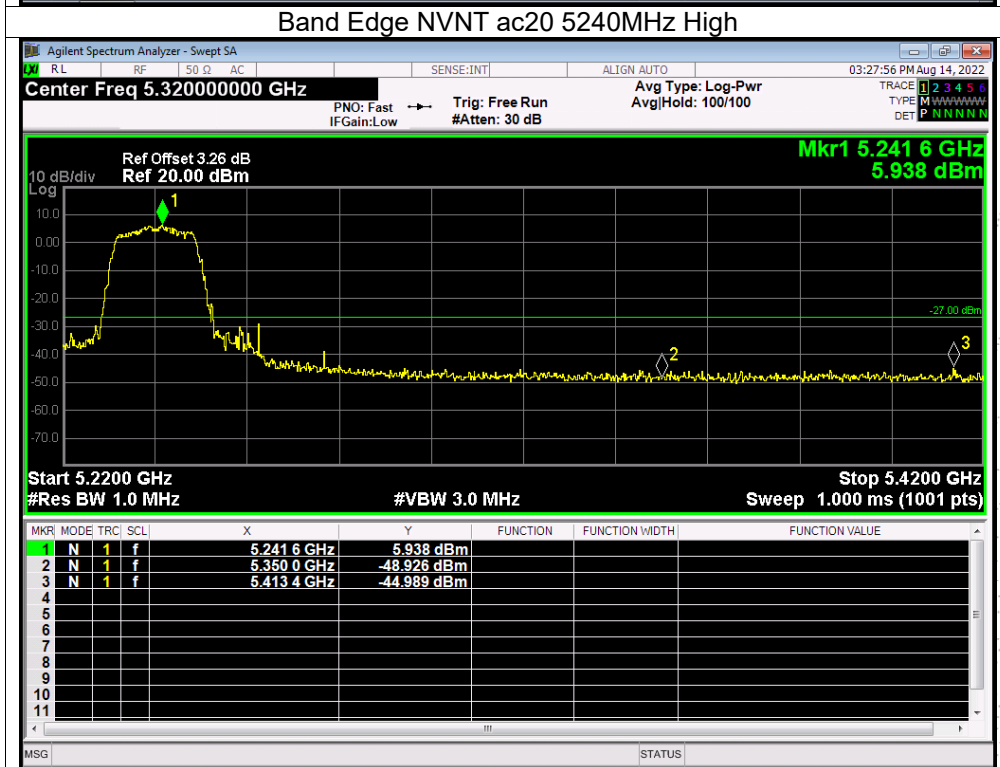
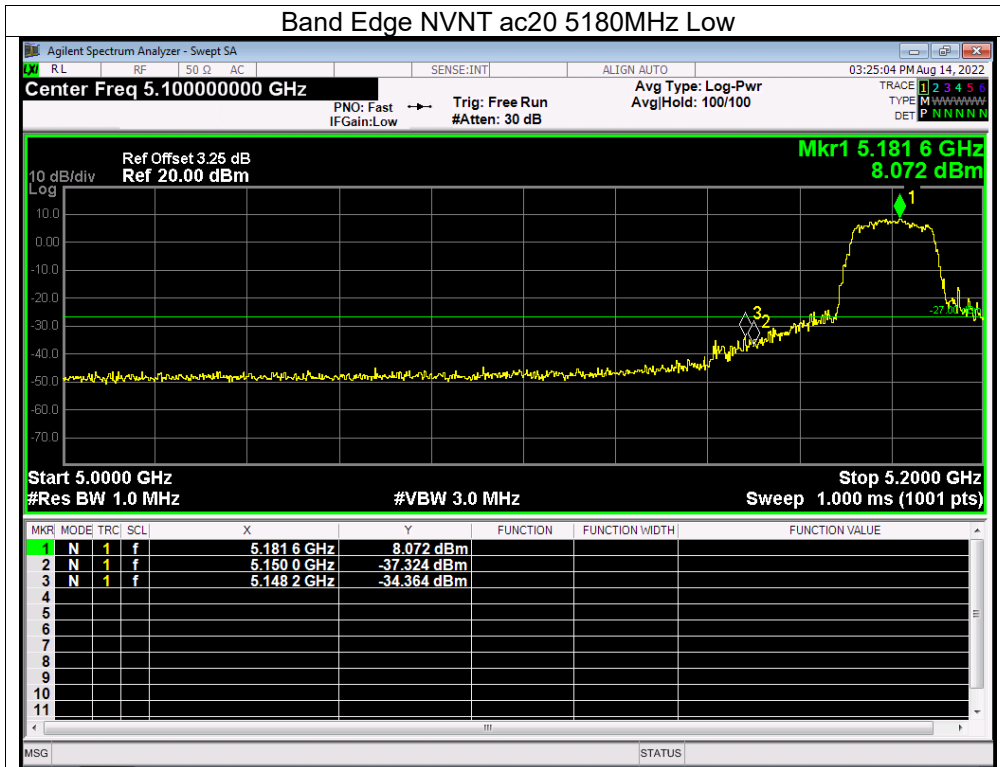

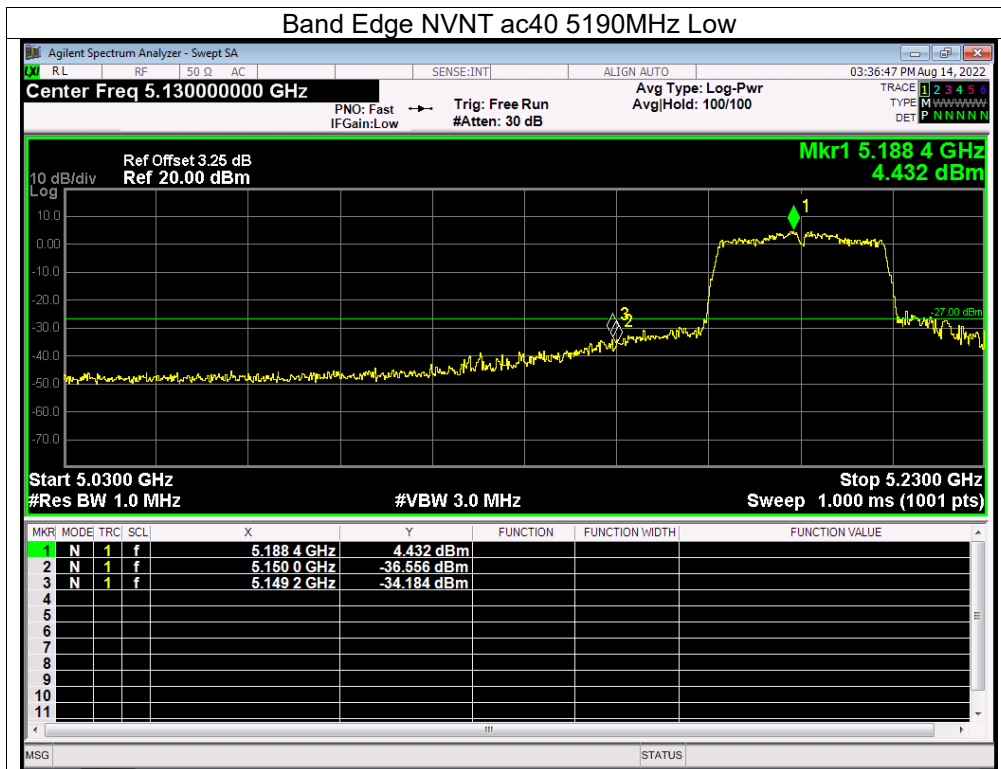

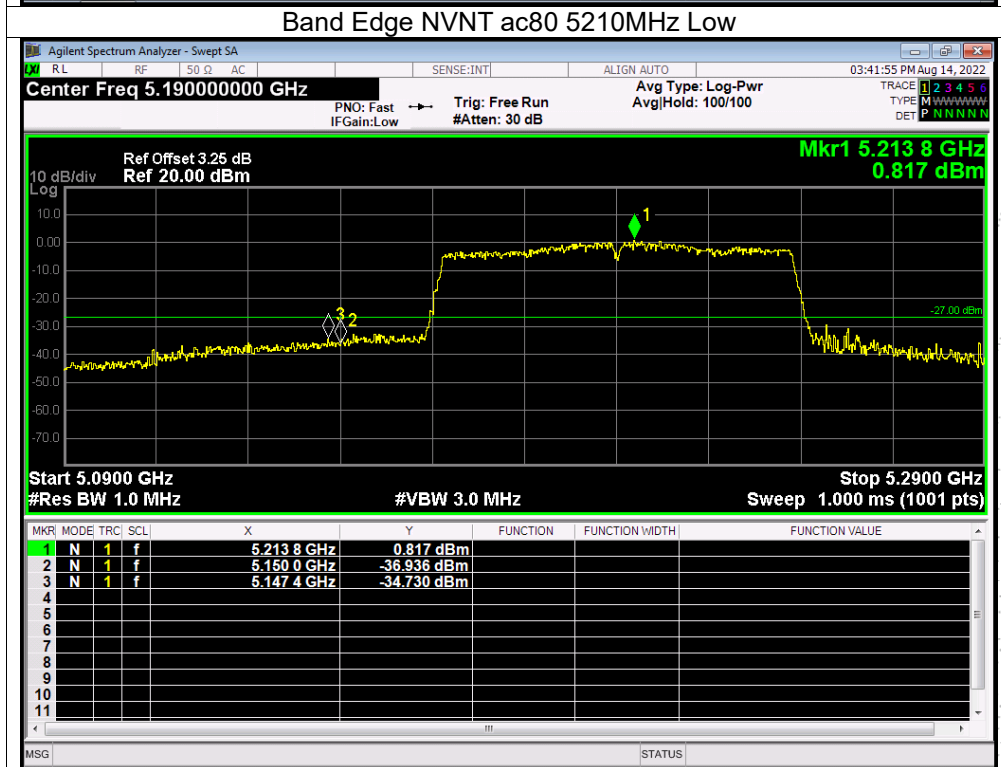
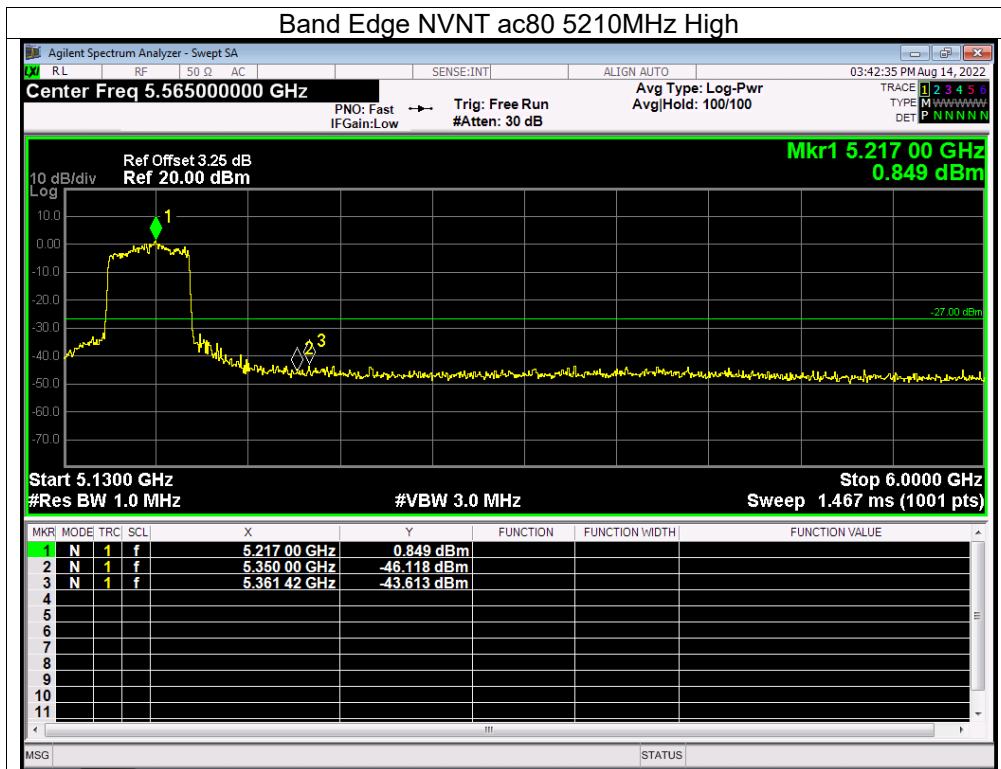

12. Spurious RF Conducted Emissions

12.1 Block Diagram Of Test Setup



12.2 Limit

Undesirable emission limits. Except as shown in paragraph (b)(7) of this section, the maximum emissions outside of the frequency bands of operation shall be attenuated in accordance with the following limits:

(1) For transmitters operating in the 5.15-5.25 GHz band: All emissions outside of the 5.15-5.35 GHz band shall not exceed an e.i.r.p. of -27 dBm/MHz.

(2) For transmitters operating in the 5.725-5.85 GHz band(i) All emissions shall be limited to a level of -27 dBm/MHz at 75 MHz or more above or below the band edge increasing linearly to 10 dBm/MHz at 25 MHz above or below the band edge, and from 25 MHz above or below the band edge increasing linearly to a level of 15.6 dBm/MHz at 5 MHz above or below the band edge, and from 5 MHz above or below the band edge increasing linearly to a level of 27 dBm/MHz at the band edge.

12.3 Test procedure

1. Check the calibration of the measuring instrument using either an internal calibrator or a known signal from an external generator.
2. Position the EUT without connection to measurement instrument. Turn on the EUT and connect its antenna terminal to measurement instrument via a low loss cable. Then set it to any one measured frequency within its operating range, and make sure the instrument is operated in its linear range.
3. Set RBW of spectrum analyzer to 1 MHz with a convenient frequency span.
4. Measure the highest amplitude appearing on spectral display and set it as a reference level. Plot the graph with marking the highest point and edge frequency.
5. Repeat above procedures until all measured frequencies were complete.

12.4 Test Result

Remark: The measurement frequency range is from 9KHz to the 10th harmonic of the fundamental frequency. The lowest, middle and highest channels are tested to verify the spurious emissions and bandege measurement data.

About: 26.5GHz-40GHz, The amplitude of spurious emissions which are attenuated by more than 20dB below the permissible value has no need to be reported.

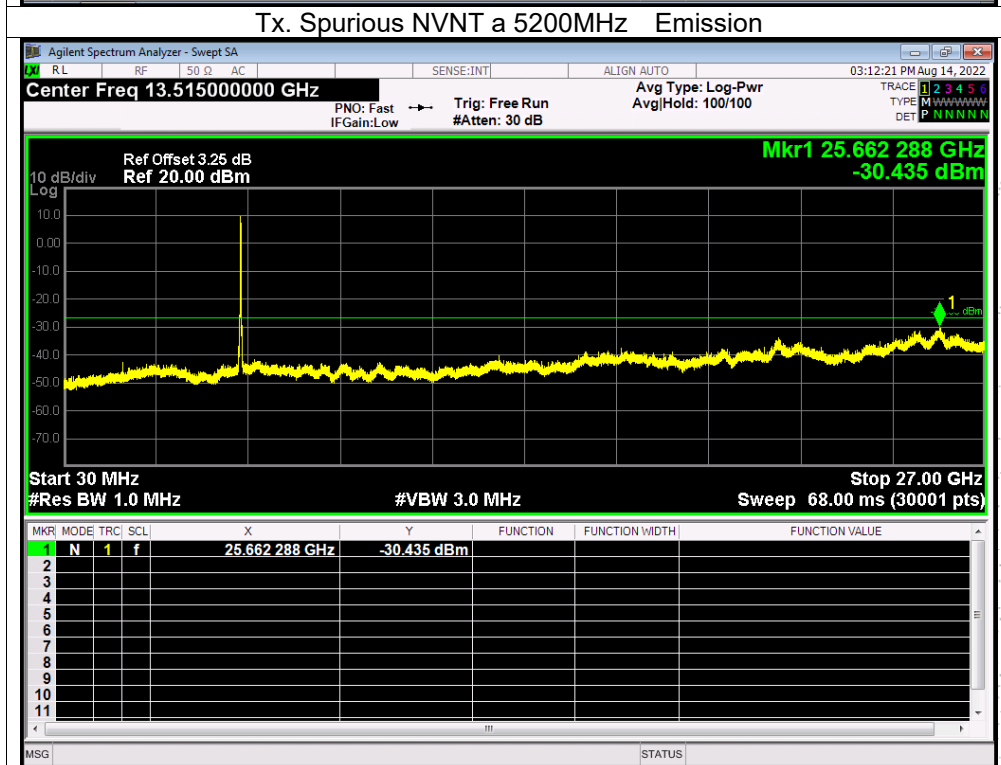
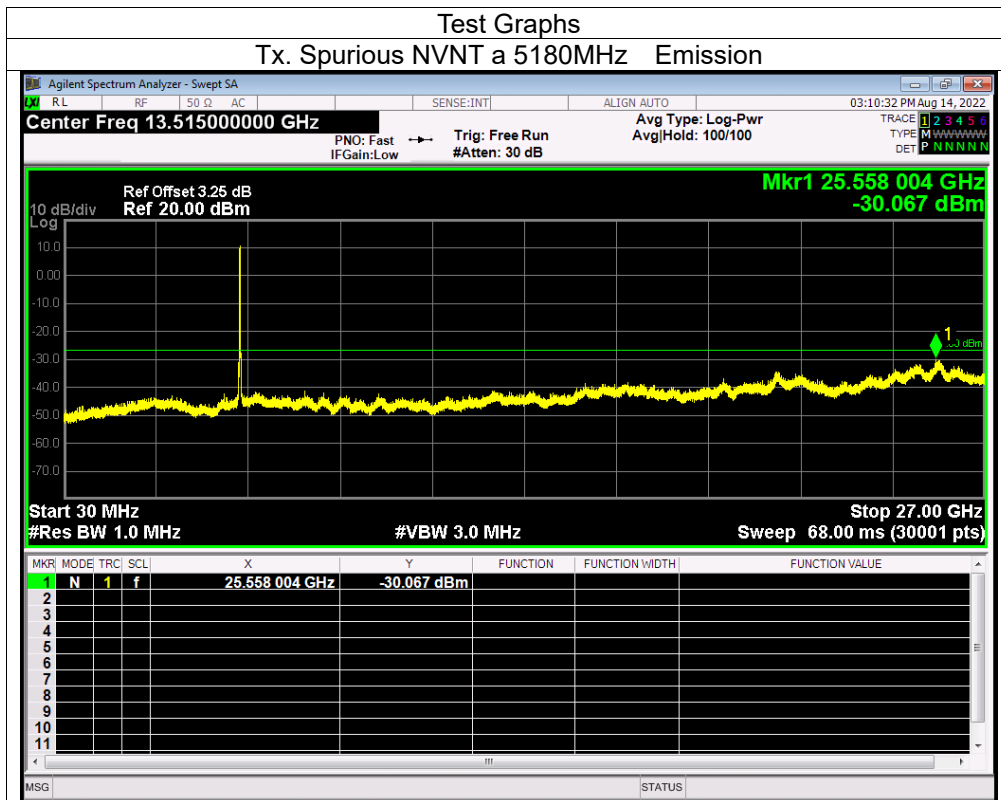

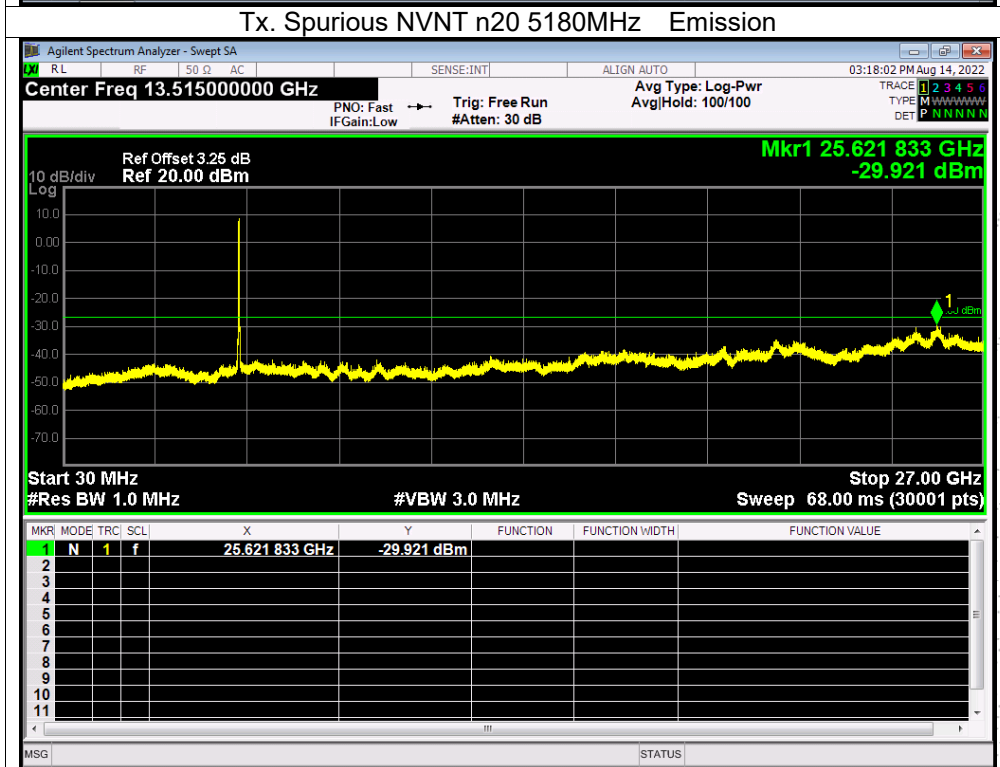
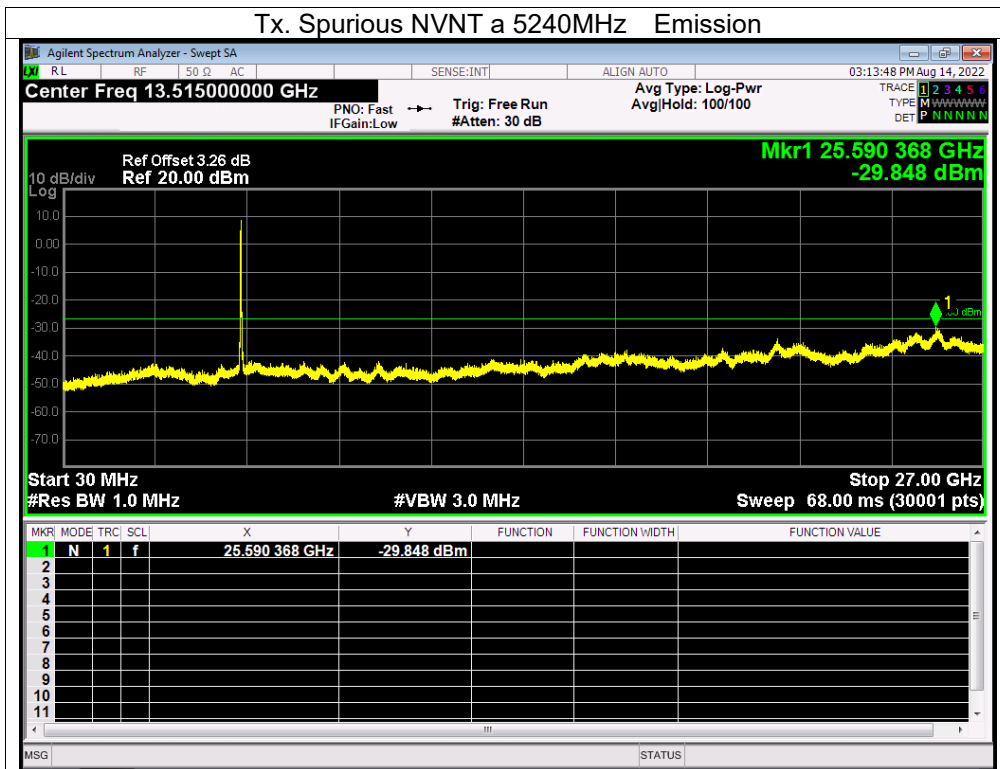

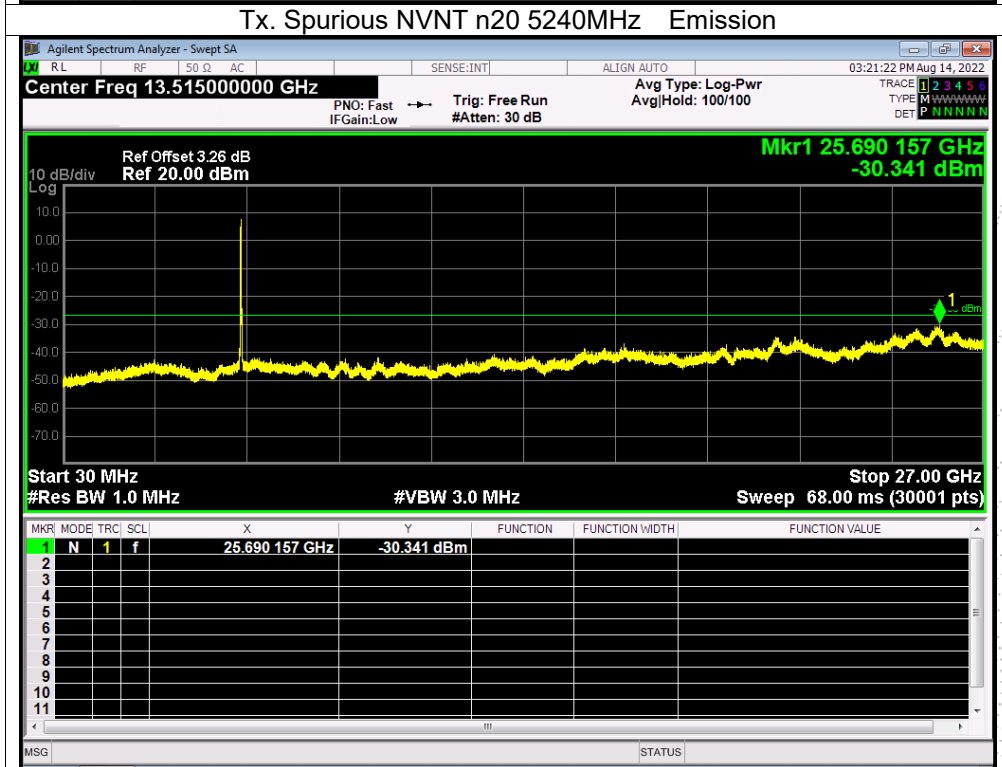
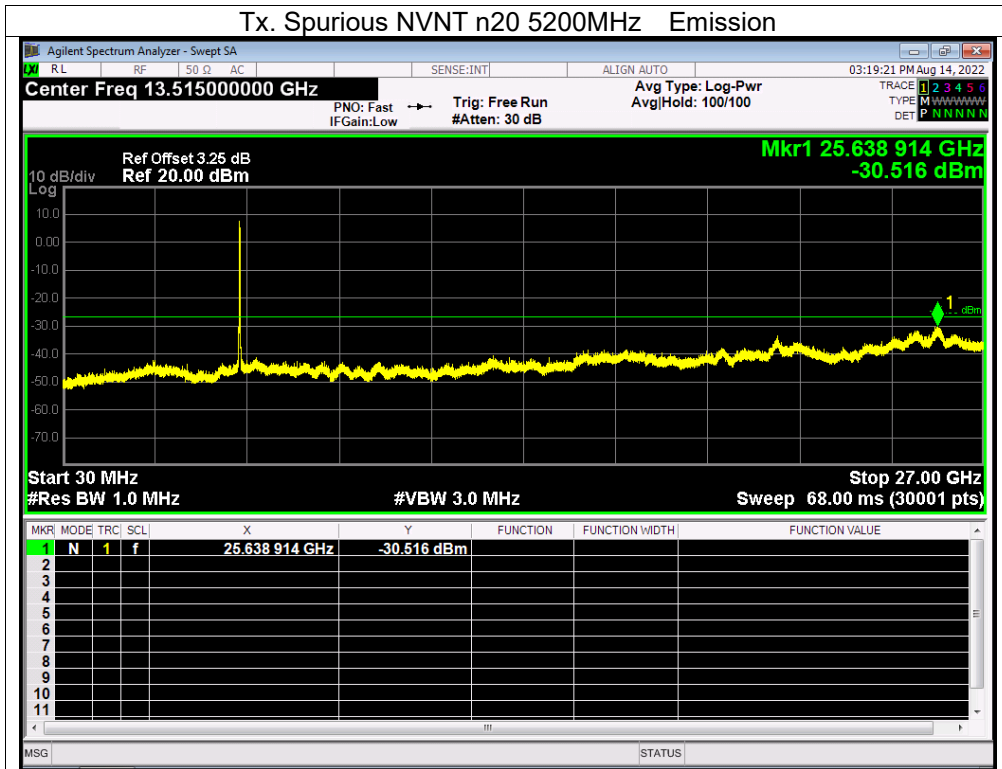

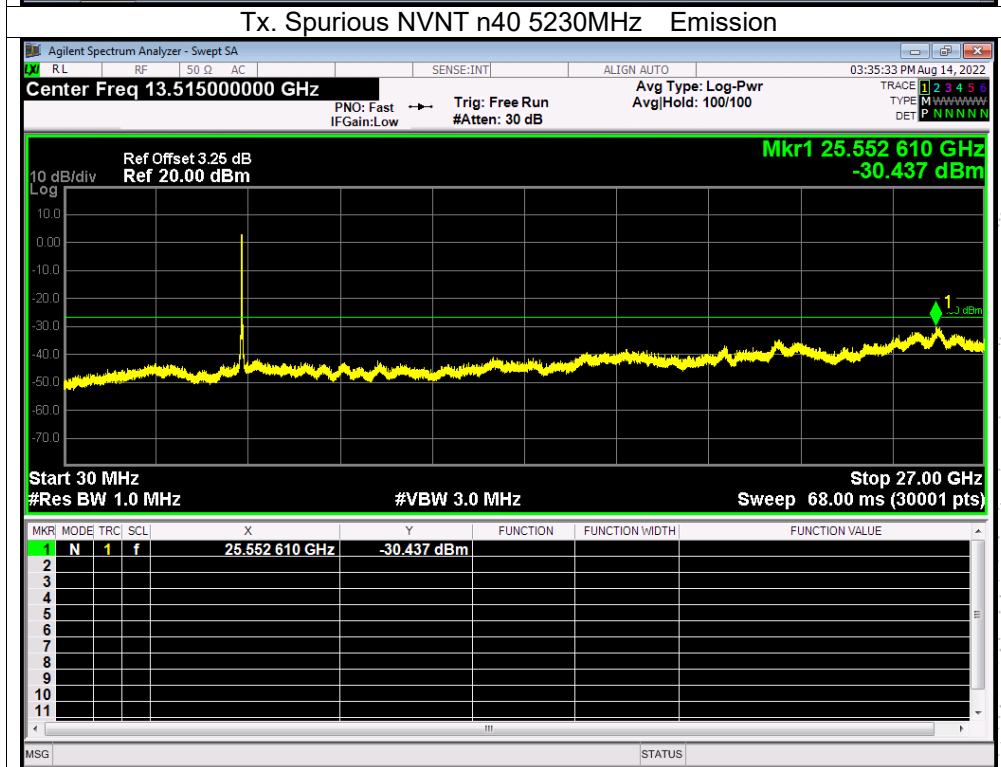
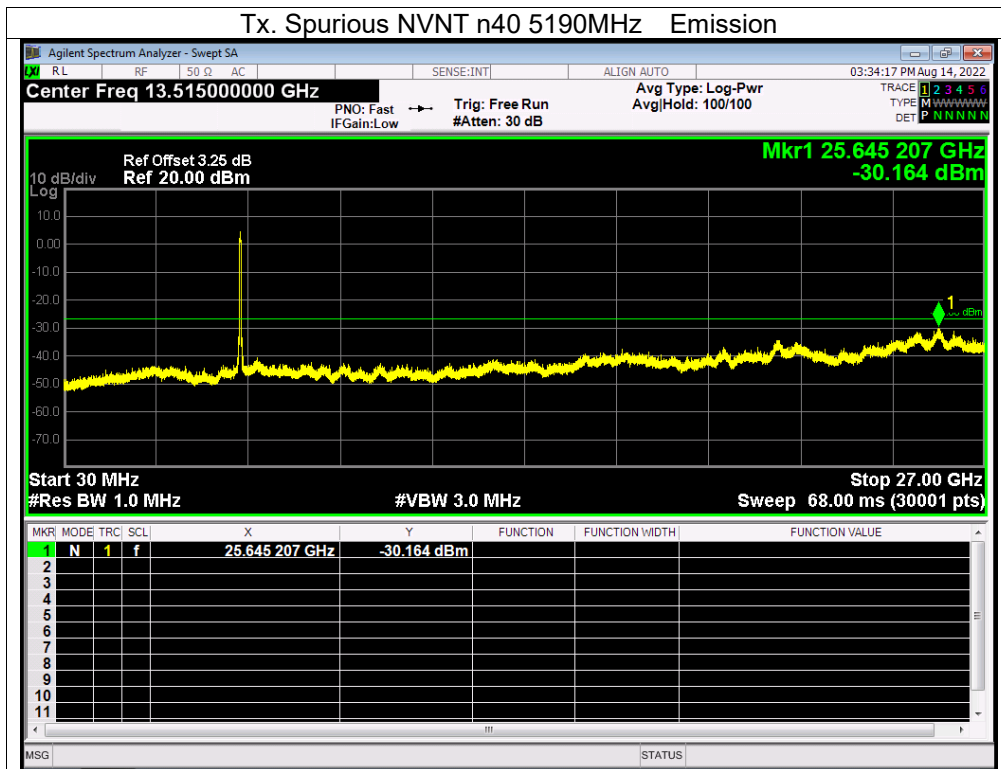

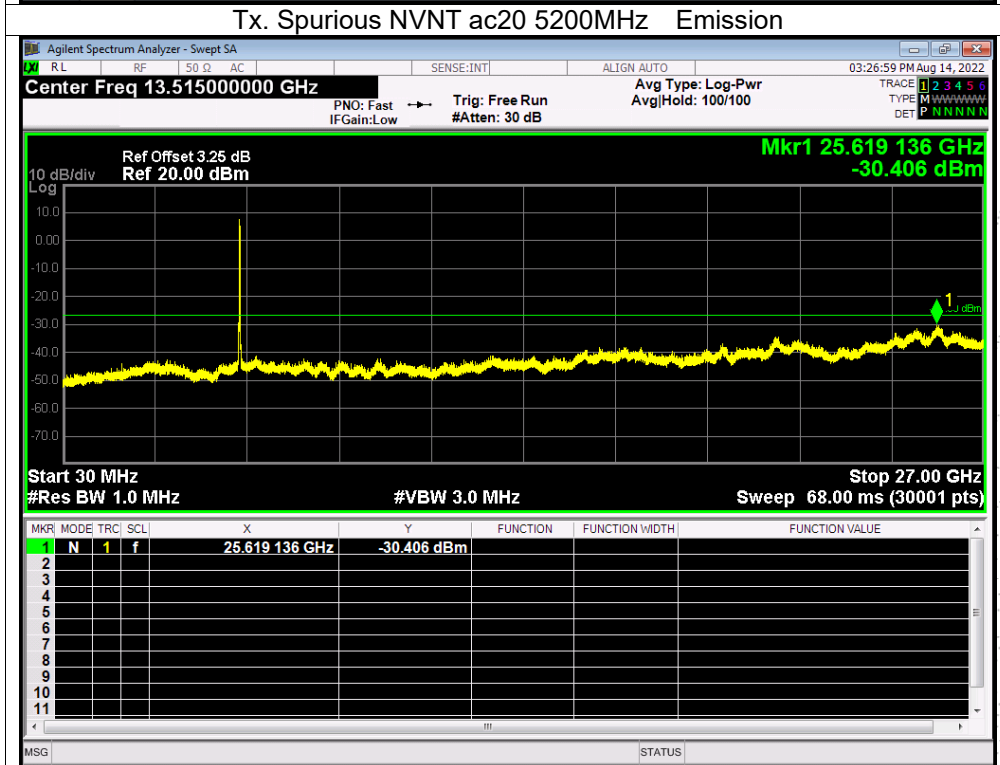
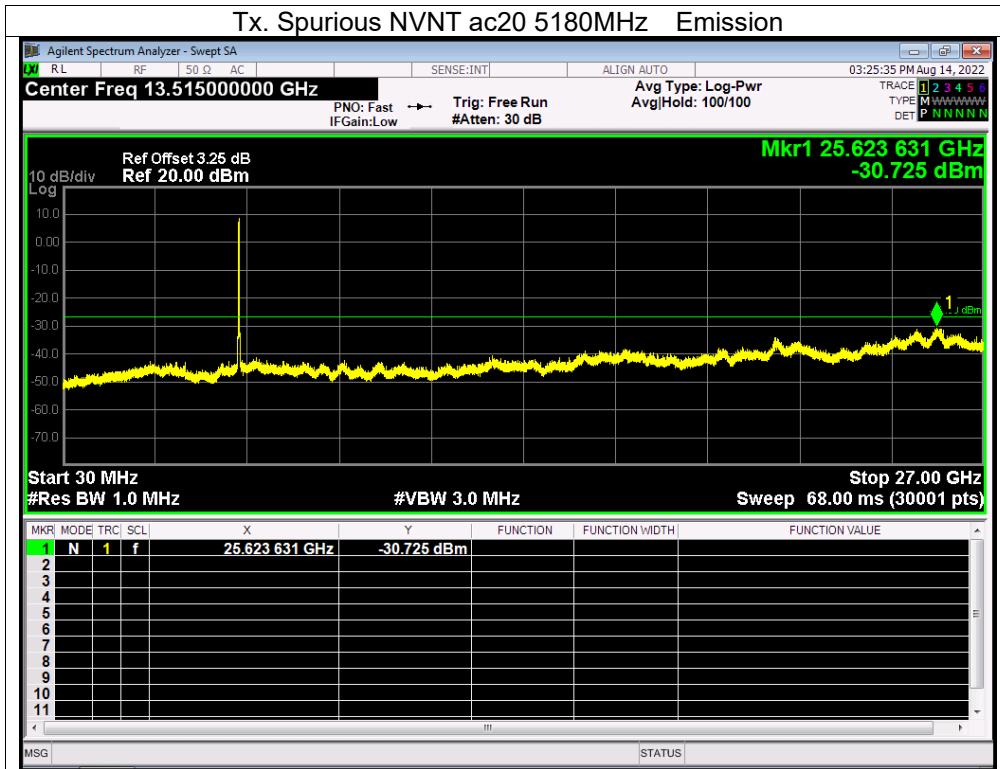

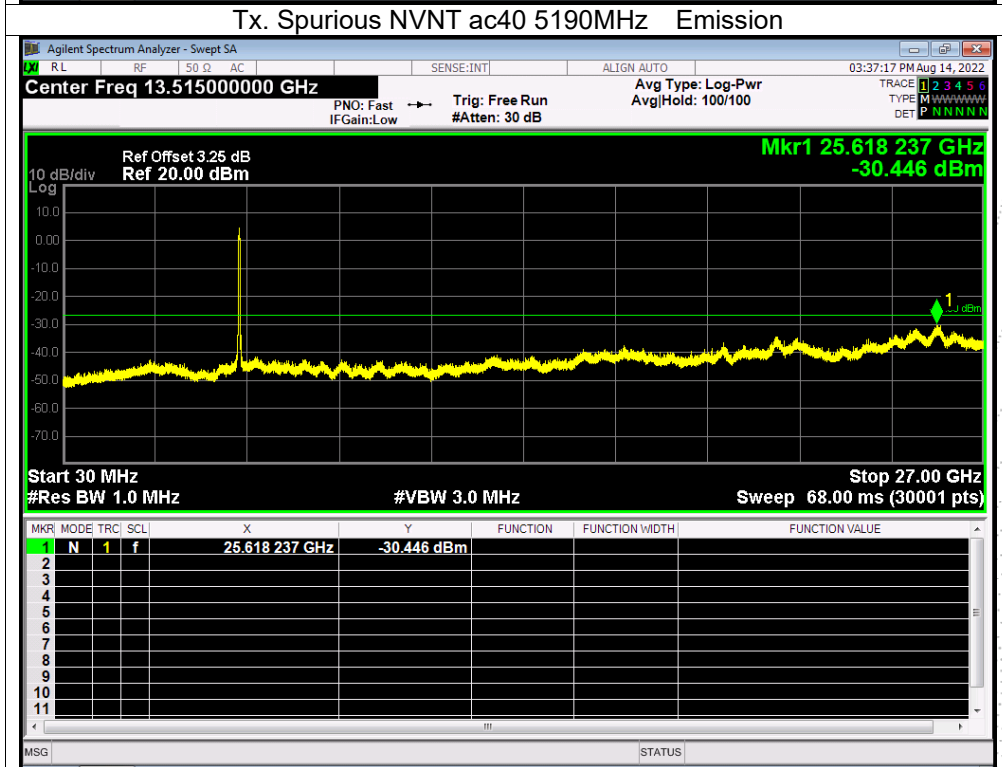
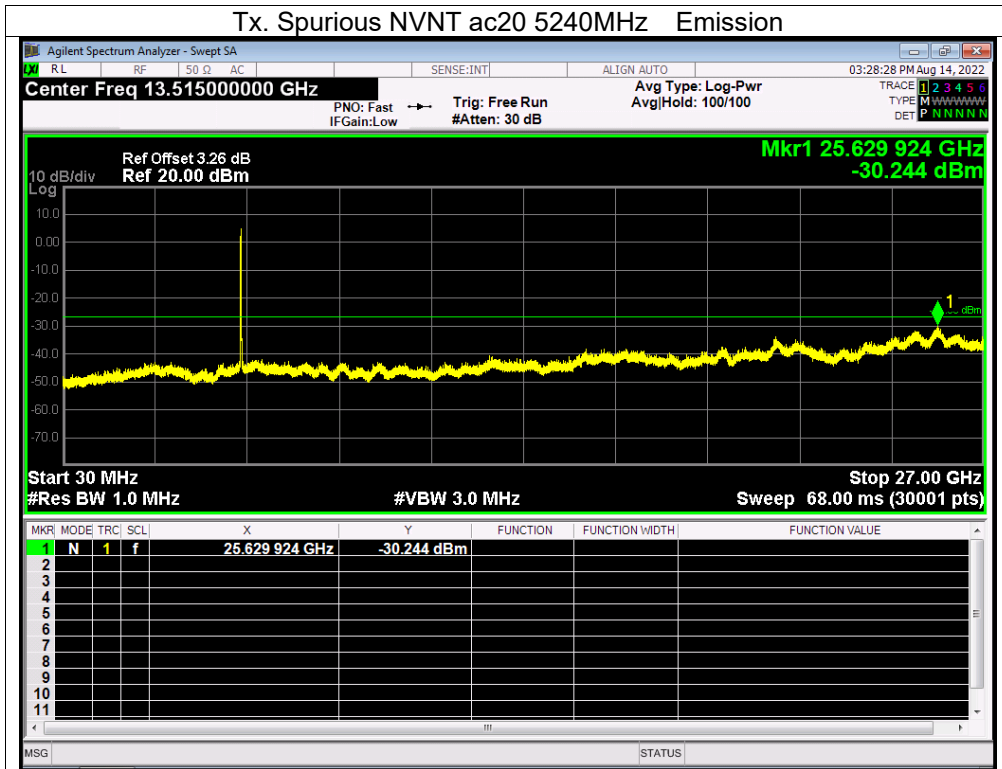

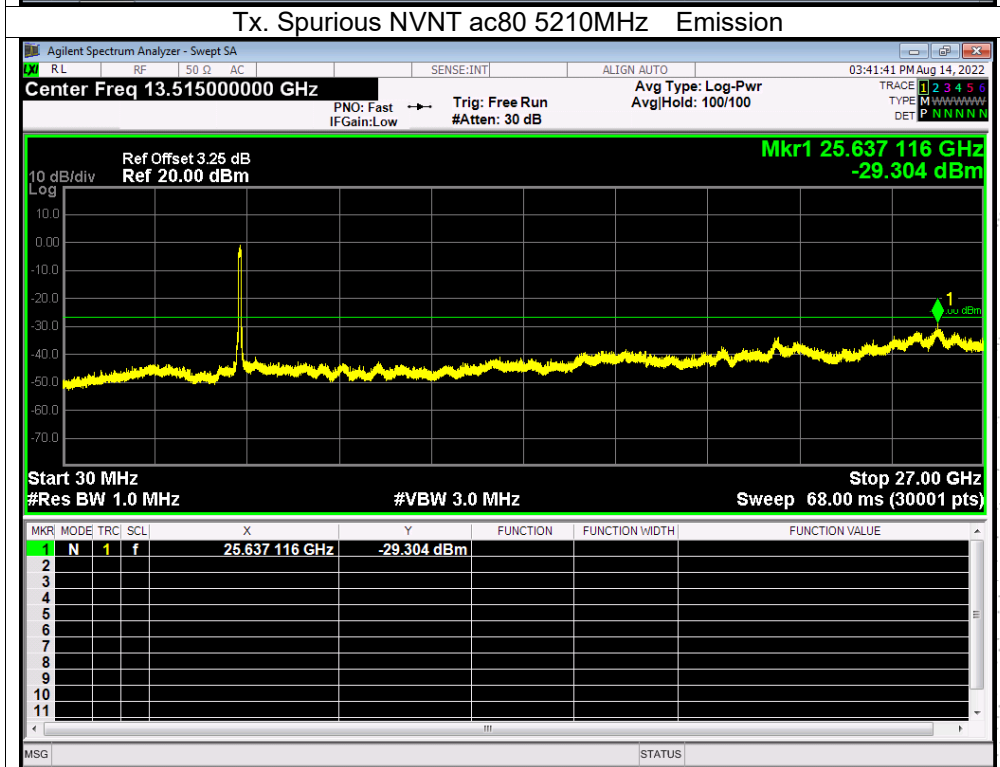
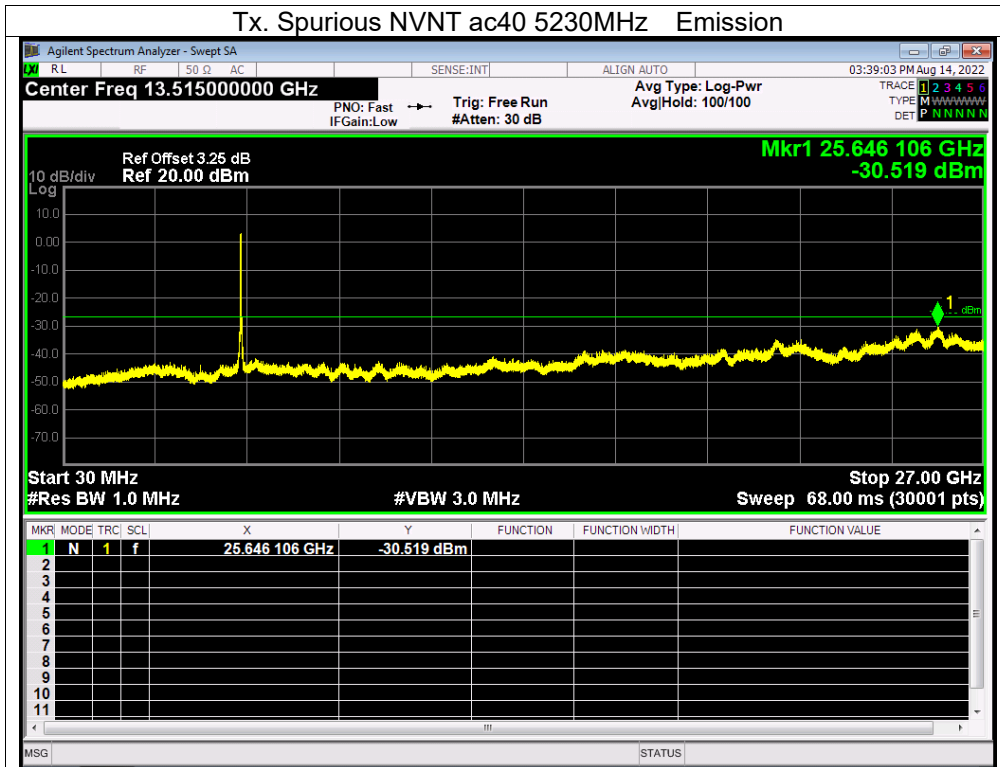

13. Frequency Stability Measurement

13.1 Block Diagram Of Test Setup



13.2 Limit

Manufactures of U-NII devices are responsible for ensuring frequency stability such that an emission is maintained within the band of operation under all conditions of normal operation as specified in the user's manual.

The transmitter center frequency tolerance shall be ± 20 ppm maximum for the 5 GHz band (IEEE 802.11n specification).

13.3 Test procedure

1. The transmitter output (antenna port) was connected to the spectrum analyzer.
2. EUT have transmitted absence of modulation signal and fixed channelize.
3. Set the spectrum analyzer span to view the entire absence of modulation emissions bandwidth.
4. Set RBW = 10 kHz, VBW = 10 kHz with peak detector and maxhold settings.
5. f_c is declaring of channel frequency. Then the frequency error formula is $(f_c - f) / f_c \times 10^6$ ppm and he limit is less than ± 20 ppm (IEEE 802.11n specification).
6. The test extreme voltage is to change the primary supply voltage from 85 to 115 percent of the nominal value
7. Extreme temperature is $-20^\circ\text{C} \sim 70^\circ\text{C}$.

13.4 Test Result

Temperature:	26 °C	Relative Humidity:	54%
Pressure:	101KPa	Test Voltage:	AC 120V/60Hz
Test Mode:	TX (5.1G) Mode Frequency U-NII-1 (5180-5240MHz)		

Voltage vs. Frequency Stability

TEST CONDITIONS				Reference Frequency: 5180MHz			
				f	fc	Max. Deviation (MHz)	Max. Deviation (ppm)
T nom (°C)	20	V nom (V)	120.00	5180.0046	5180	0.0046	0.8830
		V max (V)	138.00	5180.0033	5180	0.0033	0.6376
		V min (V)	102.00	5180.0162	5180	0.0162	3.1234
Limits				5150-5250 MHz			
Result				Complies			

Temperature vs. Frequency Stability

TEST CONDITIONS				Reference Frequency: 5180MHz			
				f	fc	Max. Deviation (MHz)	Max. Deviation (ppm)
V nom (V)	120	T (°C)	-20	5180.0028	5180	0.0028	0.5479
		T (°C)	-10	5180.0105	5180	0.0105	2.0314
		T (°C)	0	5180.0108	5180	0.0108	2.0818
		T (°C)	10	5180.0068	5180	0.0068	1.3110
		T (°C)	20	5180.0034	5180	0.0034	0.6617
		T (°C)	30	5180.0009	5180	0.0009	0.1815
		T (°C)	40	5180.0039	5180	0.0039	0.7454
		T (°C)	50	5180.0047	5180	0.0047	0.9112
		T (°C)	60	5180.0084	5180	0.0084	1.6183
		T (°C)	70	5180.0086	5180	0.0086	1.6588
Limits				5150-5250 MHz			
Result				Complies			

Voltage vs. Frequency Stability

TEST CONDITIONS				Reference Frequency: 5200MHz			
				f	fc	Max. Deviation (MHz)	Max. Deviation (ppm)
T nom (°C)	20	V nom (V)	120.00	5200.0017	5200	0.0017	0.3277
		V max (V)	138.00	5200.0037	5200	0.0037	0.7161
		V min (V)	102.00	5200.0116	5200	0.0116	2.2304
Limits				5725-5850 MHz			
Result				Complies			

Temperature vs. Frequency Stability

TEST CONDITIONS				Reference Frequency: 5200MHz			
				f	fc	Max. Deviation (MHz)	Max. Deviation (ppm)
V nom (V)	120	T (°C)	-20	5200.00705	5200	0.00705	1.3560
		T (°C)	-10	5200.00059	5200	0.00059	0.1126
		T (°C)	0	5200.01174	5200	0.01174	2.2586
		T (°C)	10	5200.01022	5200	0.01022	1.9648
		T (°C)	20	5200.00686	5200	0.00686	1.3194
		T (°C)	30	5200.00652	5200	0.00652	1.2539
		T (°C)	40	5200.00837	5200	0.00837	1.6092
		T (°C)	50	5200.01300	5200	0.01300	2.5002
		T (°C)	60	5200.00194	5200	0.00194	0.3736
		T (°C)	70	5200.00660	5200	0.00660	1.2685
Limits				5150-5250 MHz			
Result				Complies			

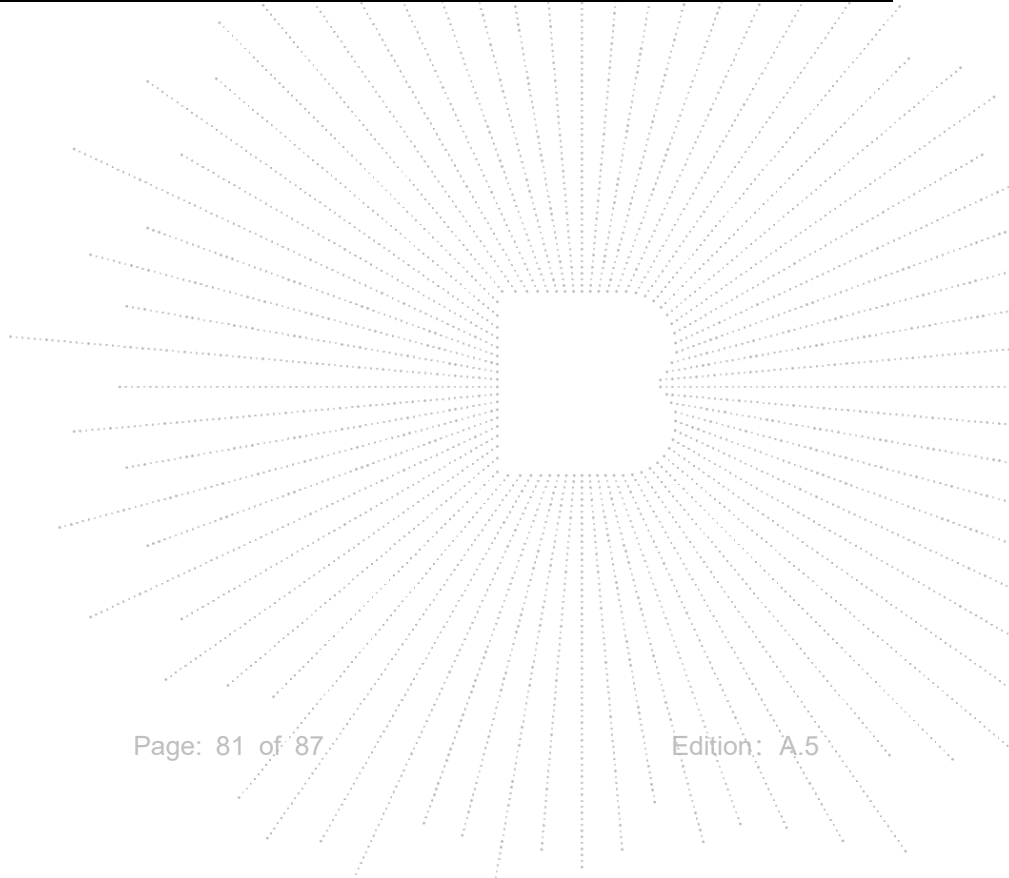

Voltage vs. Frequency Stability

TEST CONDITIONS				Reference Frequency: 5240MHz			
				f	fc	Max. Deviation (MHz)	Max. Deviation (ppm)
T nom (°C)	20	V nom (V)	120.00	5240.0050	5240	0.0050	0.9473
		V max (V)	138.00	5240.0052	5240	0.0052	0.9940
		V min (V)	102.00	5240.0110	5240	0.0110	2.1051
Limits				5150-5250 MHz			
Result				Complies			

Temperature vs. Frequency Stability

TEST CONDITIONS				Reference Frequency: 5240MHz			
				f	fc	Max. Deviation (MHz)	Max. Deviation (ppm)
V nom (V)	120	T (°C)	-20	5240.0046	5240	0.0046	0.8824
		T (°C)	-10	5240.0028	5240	0.0028	0.5273
		T (°C)	0	5240.0089	5240	0.0089	1.6890
		T (°C)	10	5240.0025	5240	0.0025	0.4736
		T (°C)	20	5240.0132	5240	0.0132	2.5151
		T (°C)	30	5240.0045	5240	0.0045	0.8634
		T (°C)	40	5240.0116	5240	0.0116	2.2155
		T (°C)	50	5240.0114	5240	0.0114	2.1848
		T (°C)	60	5240.0110	5240	0.0110	2.0990
		T (°C)	70	5240.0116	5240	0.0116	2.2232
Limits				5150-5250 MHz			
Result				Complies			

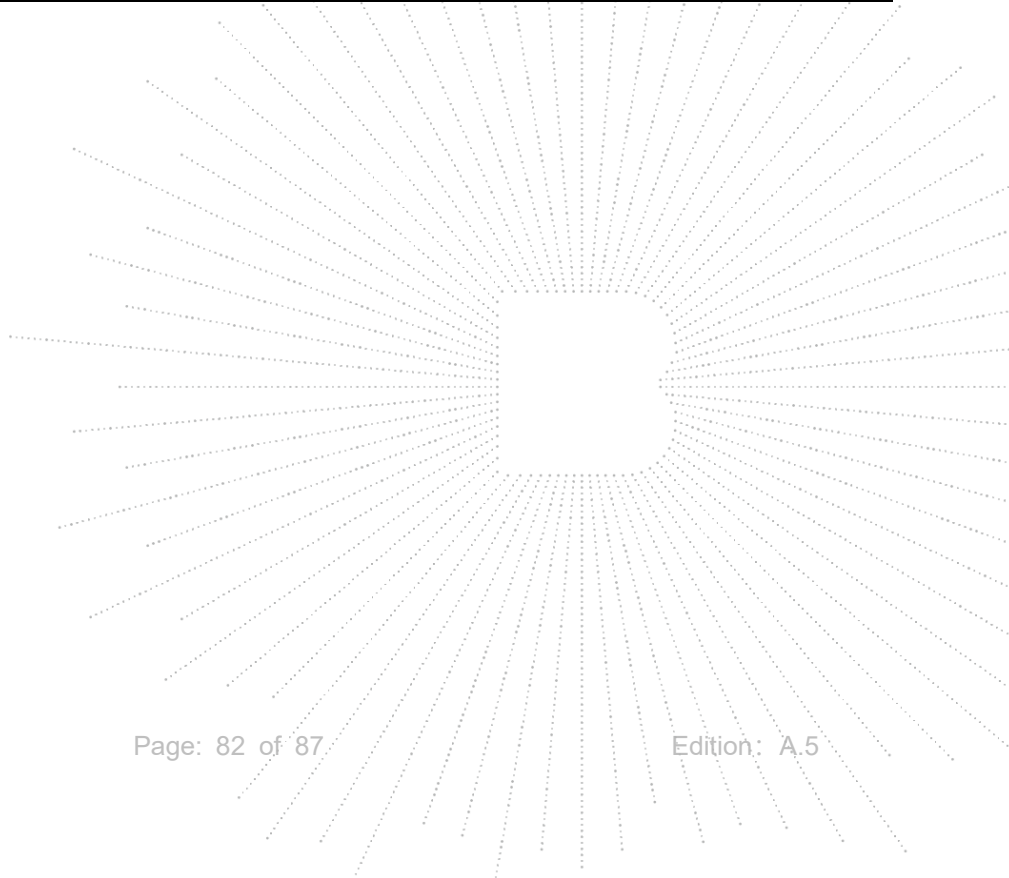

14. Antenna Requirement

14.1 Limit

15.203 requirement: For intentional device, according to 15.203: an intentional radiator shall be designed to ensure that no antenna other than that furnished by the responsible party shall be used with the device.

14.2 Test Antenna

The EUT antenna is Chip antenna (antenna gain: 2dBi). It comply with the standard requirement.

15. EUT Photographs

EUT Photo

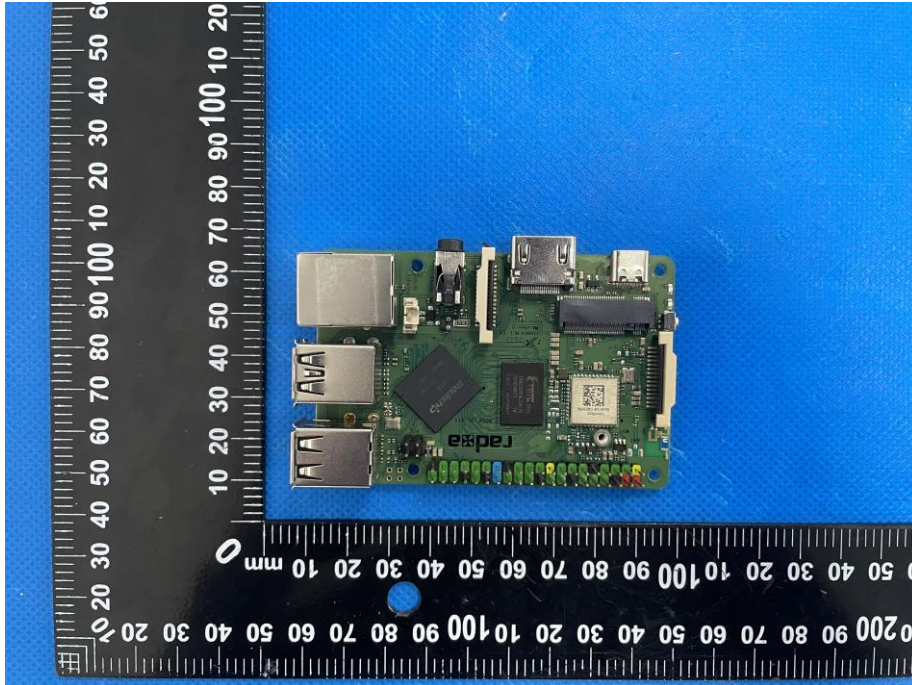

NOTE: Appendix-Photographs Of EUT Constructional Details

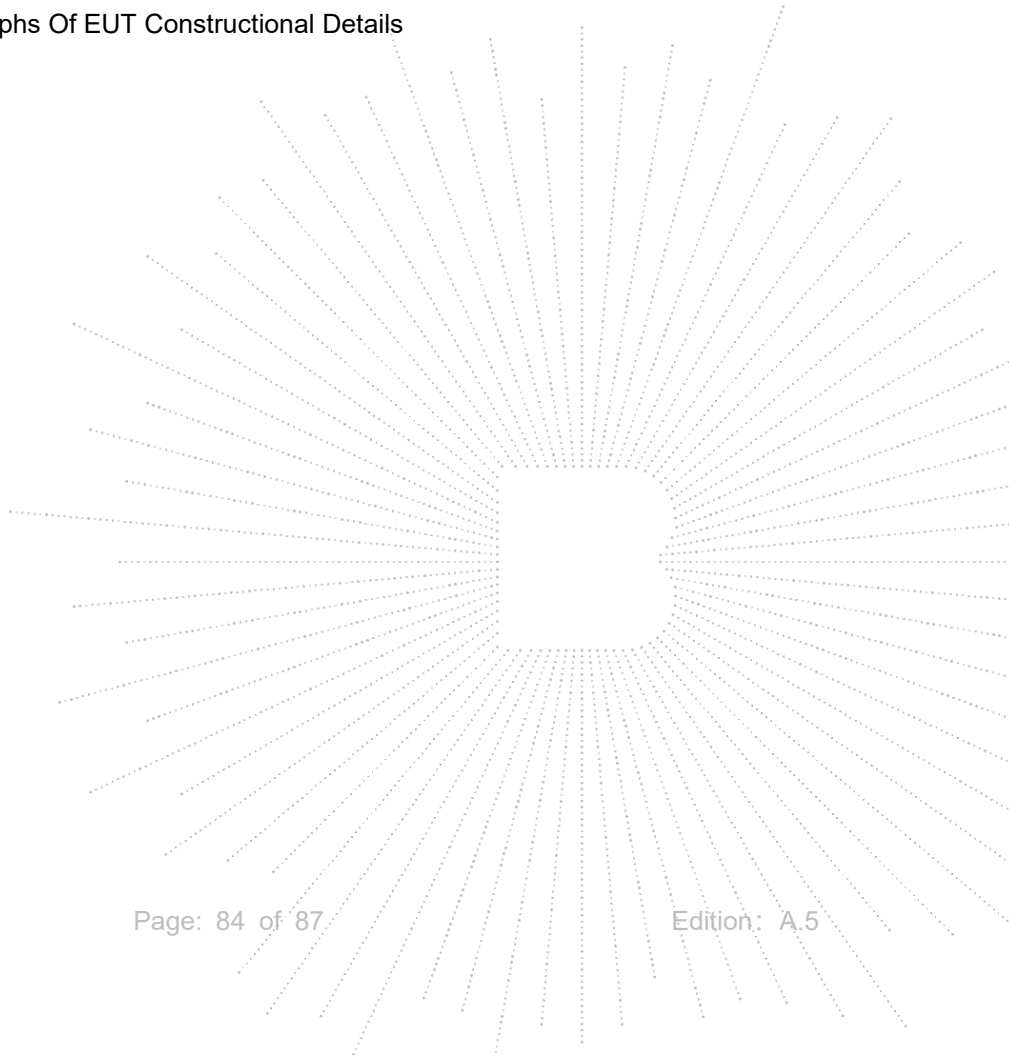

16. EUT Test Setup Photographs

Conducted emissions

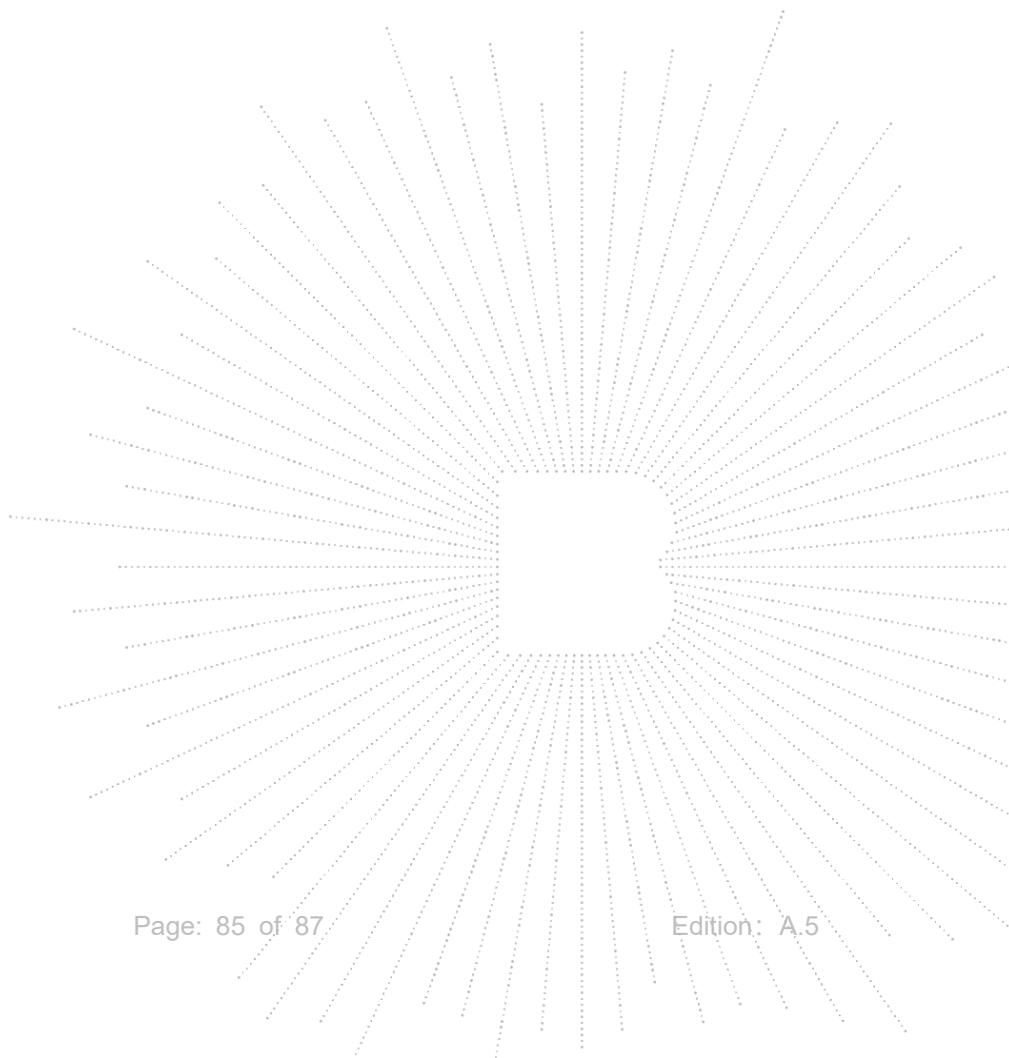

Radiated Measurement Photos

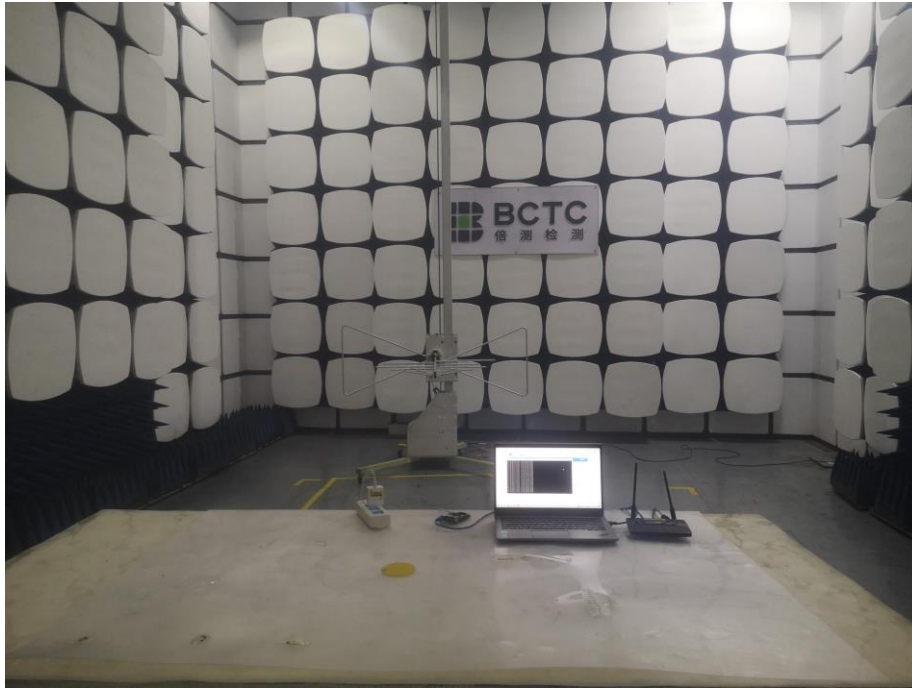

STATEMENT

1. The equipment lists are traceable to the national reference standards.
2. The test report can not be partially copied unless prior written approval is issued from our lab.
3. The test report is invalid without the "special seal for inspection and testing".
4. The test report is invalid without the signature of the approver.
5. The test process and test result is only related to the Unit Under Test.
6. Sample information is provided by the client and the laboratory is not responsible for its authenticity.
7. The test report without CMA mark is only used for scientific research, teaching, enterprise product development and internal quality control purposes.
8. The quality system of our laboratory is in accordance with ISO/IEC17025.
9. If there is any objection to this test report, the client should inform issuing laboratory within 15 days from the date of receiving test report.

Address:

1-2/F., Building B, Pengzhou Industrial Park, No.158, Fuyuan 1st Road, Zhancheng, Fuhai Subdistrict, Bao'an District, Shenzhen, Guangdong, China

TEL: 400-788-9558

P.C.: 518103

FAX: 0755-33229357

Website: <http://www.chnbctc.com>

E-Mail: bctc@bctc-lab.com.cn

***** END *****