



RADIO TEST REPORT

FCC ID : 2A3OZ-SRRGEN3
Equipment : Blind Spot Detection
Brand Name : HL Klemove
Model Name : SRR Gen3
Applicant : HL Klemove Corp.
224, Harmony-ro, Yeonsu-gu, Incheon, Republic of Korea
Manufacturer : HL Klemove Corp.
224, Harmony-ro, Yeonsu-gu, Incheon, Republic of Korea
Standard : 47 CFR FCC Part 15 Subpart C § 15.249

The product was received on Jun. 27, 2022, and testing was started from Jul. 04, 2022 and completed on Jul. 12, 2022. We, Sporton International Inc. Hsinchu Laboratory, would like to declare that the tested sample has been evaluated in accordance with the procedures given in ANSI C63.10-2013, 47 CFR FCC Part 15 Subpart C and shown compliance with the applicable technical standards.

The test results in this report apply exclusively to the tested model / sample. Without written approval of Sporton International Inc. Hsinchu Laboratory, the test report shall not be reproduced except in full.



Approved by: Sam Chen

Sporton International Inc. Hsinchu Laboratory
No.8, Ln. 724, Bo'ai St., Zhubei City, Hsinchu County 302010, Taiwan (R.O.C.)



Table of Contents

History of this test report.....	3
Summary of Test Result.....	4
1 General Information	5
1.1 Product Details	5
1.2 Table for EUT Type	5
1.3 Accessories	5
1.4 Table for Test Modes	6
1.5 Applicable Standards	6
1.6 Table for Testing Locations.....	7
1.7 Table for Supporting Units	7
1.8 Duty Cycle	7
1.9 Table for Parameters of Test Software Setting.....	7
1.10 Test Configurations	8
2 Test Result	10
2.1 Field Strength of Fundamental Emissions Measurement.....	10
2.2 20dB Spectrum Bandwidth Measurement.....	14
2.3 Radiated Emissions Measurement.....	17
2.4 Band Edge Emissions Measurement	31
2.5 Antenna Requirements	35
3 List of Measuring Equipments	36
4 Measurement Uncertainty.....	38
Appendix A. Test Photos	
Photographs of EUT v01	



History of this test report

Report No.	Version	Description	Issued Date
FR262310	01	Initial issue of report	Feb. 06, 2023
FR262310	02	Revising Max. Filed Strength in section 1.1	Mar. 14, 2023



Summary of Test Result

Report Clause	Ref Std. Clause	Test Items	Result (PASS/FAIL)	Remark
-	15.207	AC Power Line Conducted Emissions	N/A	Note
2.1	15.249(a)	Field Strength of Fundamental Emissions	PASS	-
2.2	15.215(c)	20dB Spectrum Bandwidth	PASS	-
2.3	15.249(a)/(d)	Radiated Emissions	PASS	-
2.4	15.249(d)	Band Edge Emissions	PASS	-
2.5	15.203	Antenna Requirements	PASS	-

Note: The EUT was supplied power by DC-Powered (vehicle battery); it's not necessary to apply to AC Power-line Conducted Emissions test.

Declaration of Conformity:

1. The test results with all measurement uncertainty excluded are presented in accordance with the regulation limits or requirements declared by manufacturers. It's means measurement values may risk exceeding the limit of regulation standards, if measurement uncertainty is include in test results.
2. The measurement uncertainty please refer to report "Measurement Uncertainty".

Comments and Explanations:

The declared of product specification for EUT presented in the report are provided by the manufacturer, and the manufacturer takes all the responsibilities for the accuracy of product specification.

Reviewed by: Sam Chen

Report Producer: Sophia Shiung



1 General Information

1.1 Product Details

Items	Description
Power Type	From DC 12V
Modulation	FMCW
Frequency Range	24000 ~ 24250 MHz
Operation Frequency Range	24150 ~ 24250 MHz
Testing Channel	24200 MHz
Channel Bandwidth (99%)	94.19 MHz
Max. Field Strength	69.66 dBuV/m at 3m (Average) / 79.20 dBuV/m at 1m (Average) 102.41 dBuV/m at 3m (Peak) / 111.95 dBuV/m at 1m (Peak)
Antenna	Brand: Hella KGaA Hueck & Co. Model Name: BSD3.0 Type: Microstrip patch array Gain: 11 dBi

Note: The above information was declared by manufacturer.

1.2 Table for EUT Type

The EUTs listed below are identical except for the passive components.

EUT	
Master Control Unit	Slave Control Unit

Note: The above information was declared by manufacturer.

1.3 Accessories

Item	Brand	Model	Remark
Vehicle CAN-bus	HL Klemove	SRR Gen3 Cable	Non-shielded, 1.5m



1.4 Table for Test Modes

The following table is a list of the test modes shown in this test report.

Test Items	Mode	Channel
Field Strength of Fundamental Emissions	CTX	24200 MHz
20dB Spectrum Bandwidth	CTX	24200 MHz
Radiated Emissions 30MHz~1GHz	Normal link	Random
Radiated Emissions 1GHz~40GHz	CTX	24200 MHz
Radiated Emissions 40GHz~100GHz	CTX	24200 MHz
Band Edge Emissions	CTX	24200 MHz

Note: CTX=continuously transmitting

Radiated Emissions below 1GHz:

- Test mode: 1. EUTs in X axis (Master Control Unit + Slave Control Unit)
2. EUTs in Y axis (Master Control Unit + Slave Control Unit)
3. EUTs in Z axis (Master Control Unit + Slave Control Unit)

Mode 3 generated the worst test result, so it was recorded in this report.

20dB Spectrum Bandwidth, Radiated Emissions above 1GHz, Field Strength of Fundamental Emissions and Band Edge Emissions:

- The EUT was performed at X axis, Y axis and Z axis position, and the worst case was found at X axis. So the measurement will follow this same test configuration.
- The Master Control Unit and Slave Control Unit was performed the testing, and the worst case was found at Master Control Unit. So the measurement will follow this same test configuration.

Test mode: 1. EUT in X axis (Master Control Unit) - 24200 MHz

1.5 Applicable Standards

According to the specifications of the manufacturer, the EUT must comply with the requirements of the following standards:

- ANSI C63.10-2013
- 47 CFR FCC Part 15 Subpart C § 15.249

The following reference test guidance is not within the scope of accreditation of TAF.

- FCC KDB 414788 D01 v01r01



1.6 Table for Testing Locations

Testing Location Information	
Test Lab. : Sporton International Inc. Hsinchu Laboratory	
Hsinchu ADD: No.8, Ln. 724, Bo'ai St., Zhubei City, Hsinchu County 302010, Taiwan (R.O.C.)	
(TAF: 3787)	TEL: 886-3-656-9065 FAX: 886-3-656-9085
Test site Designation No. TW3787 with FCC.	
Conformity Assessment Body Identifier (CABID) TW3787 with ISED.	

Test Condition	Test Site No.	Test Engineer	Test Environment (°C / %)	Test Date
Radiated (Below 1GHz)	10CH01-CB	Peter Wu	23~24 / 57~58	Jul. 04, 2022
Radiated (Other test items)	03CH05-CB	Bruce Yang	24.4-25.5 / 55-58	Jul. 08, 2022~ Jul. 12, 2022

1.7 Table for Supporting Units

For Radiated Emissions below 1GHz:

No.	Support Unit	Brand	Model	FCC ID
A	Vehicle battery	YUASA	38B19L-MF	N/A
B	CAN/LIN interface	Vector	VN1630A	N/A
C	NB	Samsung	HU10436-16122	N/A
D	Earphone	SHYARO CHI	MIC-04	N/A
E	Mouse	Logitech	M-U0026	N/A

For other test items:

No.	Support Unit	Brand	Model	FCC ID
A	Vehicle battery	YUASA	38B19L-MF	N/A

1.8 Duty Cycle

TX-on (ms)	TX-on+TX-off (ms)	Duty cycle (%)	Correction Factor (Db)
1.2	52.09	2.303705126	-32.75

1.9 Table for Parameters of Test Software Setting

Test Software Version	1.00
Frequency	24200 MHz
Software Setting	Default

1.10 Test Configurations

1.10.1 Radiation Emissions Test Configuration

Test Configuration: 30MHz~1GHz

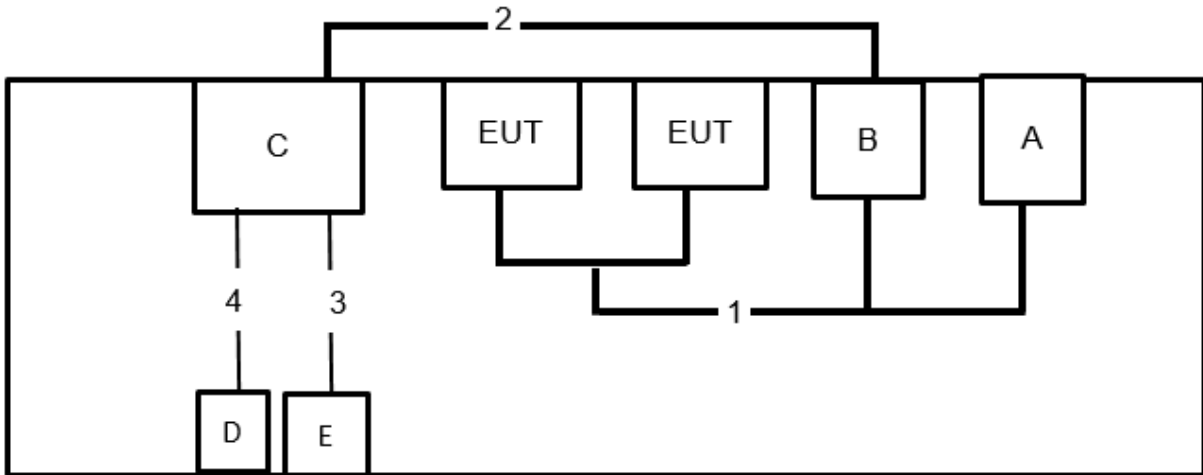

Item	Connection	Shielded	Length
1	Vehicle CAN-bus	No	1.5m
2	USB Cable	Yes	1.5m
3	USB Cable	Yes	1.5m
4	Audio Cable	Yes	1.5m

Test Configuration: Above 1GHz

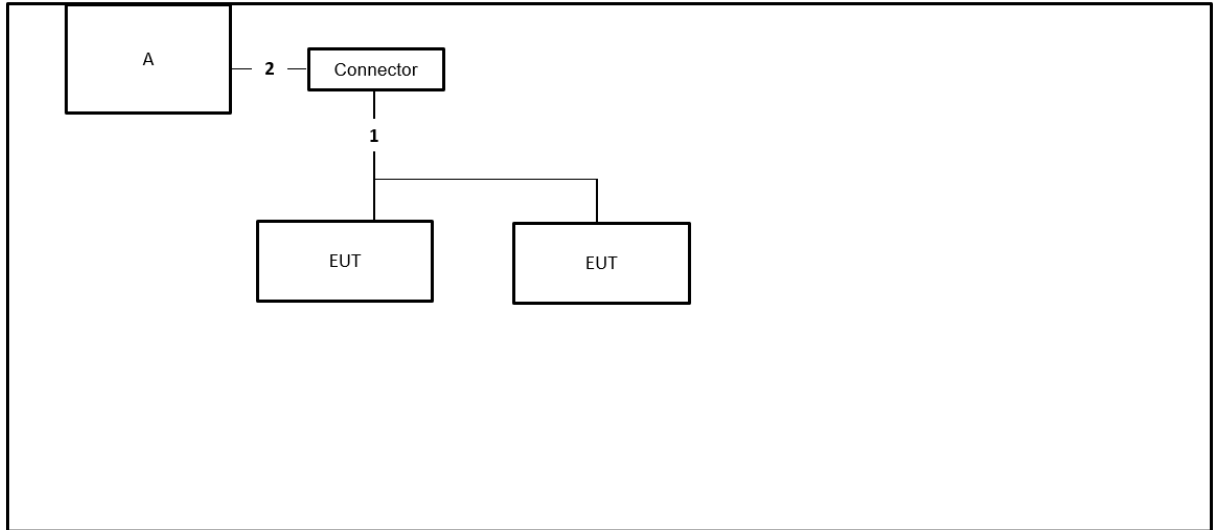

Item	Connection	Shielded	Length
1	Vehicle CAN-bus	No	1.5m
2	Crocodile clip cable*2	No	1.5m



2 Test Result

2.1 Field Strength of Fundamental Emissions Measurement

2.1.1 Limit

The field strength of fundamental emissions within these bands specified at a distance of 3 meters (measurement instrumentation employing an average detector) shall comply with the following table.

Frequency Band	Fundamental Emissions Limit Average/Peak (dBuV/m) at 3m
24000 ~ 24250 MHz	107.96/127.96

Note 1: 107.96 dBuV/m rounding to 108dBuV/m and 127.96 dBuV/m rounding to 128dBuV/m

Note 2: Above 10 GHz shall be extrapolated to the specified distance using an extrapolation factor of 20 dB/decade from 3m to 1m.

Distance extrapolation factor = $20 \log(\text{specific distance [3m]} / \text{test distance [1m]})$ (dB);

Limit line = specific limits (dBuV) + distance extrapolation factor [9.54 dB].

Average limit = 108dBuV/m + distance extrapolation factor (9.54 dB) =117.54dBuV/m.

Peak limit = 128dBuV/m + distance extrapolation factor (9.54 dB) =137.54dBuV/m.

2.1.2 Measuring Instruments and Setting

Refer a test equipment and calibration data table in this test report. The following table is the setting of the spectrum analyzer.

Power Meter Parameter	Setting
RBW	1 MHz Peak / 3MHz Average
VBW	1 MHz Peak / 1/T Average
Detector	Peak
Trace	Max Hold
Sweep Time	Auto

2.1.3 Test Procedures

1. Configure the EUT according to ANSI C63.10. The EUT was placed on the top of the turntable 1.5 meter above ground. The phase center of the receiving antenna mounted on the top of a height-variable antenna tower was placed 3 meters far away from the turntable.
2. Power on the EUT and all the supporting units. The turntable was rotated by 360 degrees to determine the position of the highest radiation.
3. The height of the broadband receiving antenna was varied between one meter and four meters above ground to find the maximum emissions field strength of both horizontal and vertical polarization.
4. For each suspected emissions, the antenna tower was scan (from 1 M to 4 M) and then the turntable

was rotated (from 0 degree to 360 degrees) to find the maximum reading.

5. For Fundamental emissions, use 1MHz VBW and 3MHz RBW for peak reading. Then 1MHz RBW and 1/T VBW for average reading in spectrum analyzer.
6. When the radiated emissions limits are expressed in terms of the average value of the emissions, and pulsed operation is employed, the measurement field strength shall be determined by averaging over one complete pulse train, including blanking intervals, as long as the pulse train does not exceed 0.1 seconds. As an alternative (provided the transmitter operates for longer than 0.1 seconds) or in cases where the pulse train exceeds 0.1 seconds, the measured field strength shall be determined from the average absolute voltage during a 0.1 second interval during which the field strength is at its maximum value.

2.1.4 Test Setup Layout

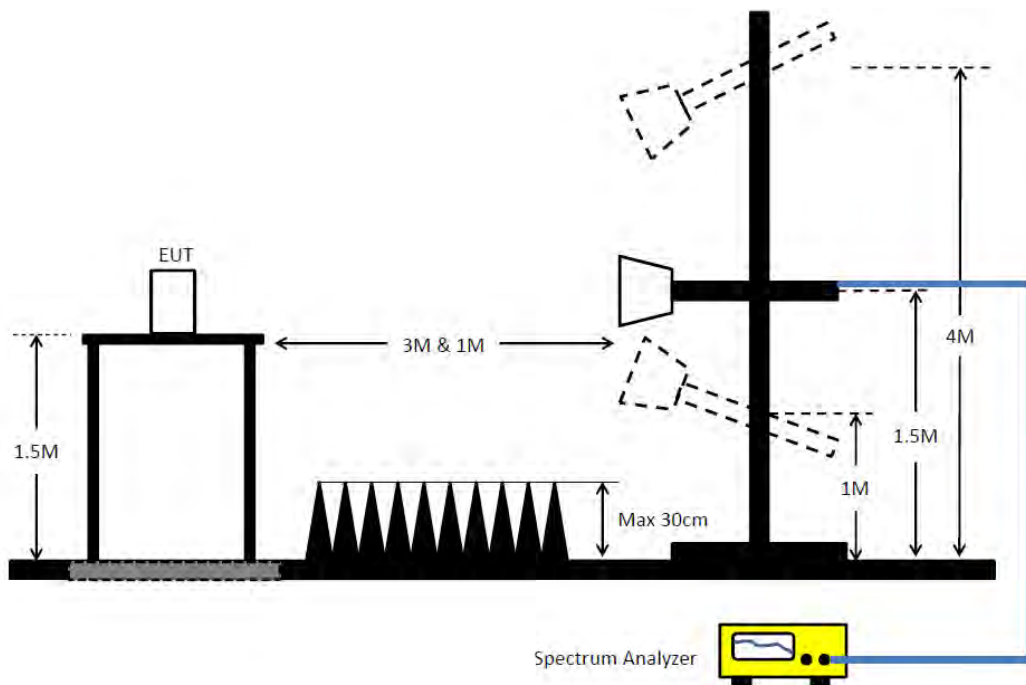

2.1.5 Test Deviation

There is no deviation with the original standard.

2.1.6 EUT Operation during Test

The EUT was programmed to be in continuously transmitting mode.

2.1.7 Measurement Results Calculation

The measured Level is calculated using:

Corrected Reading: $Antenna\ factor\ (AF) + Cable\ loss\ (CL) + Read\ level\ (Raw) - Preamp\ factor\ (PA)$ (if applicable) = Level.



2.1.8 Test Result of Field Strength of Fundamental Emissions

Horizontal

Mode 1

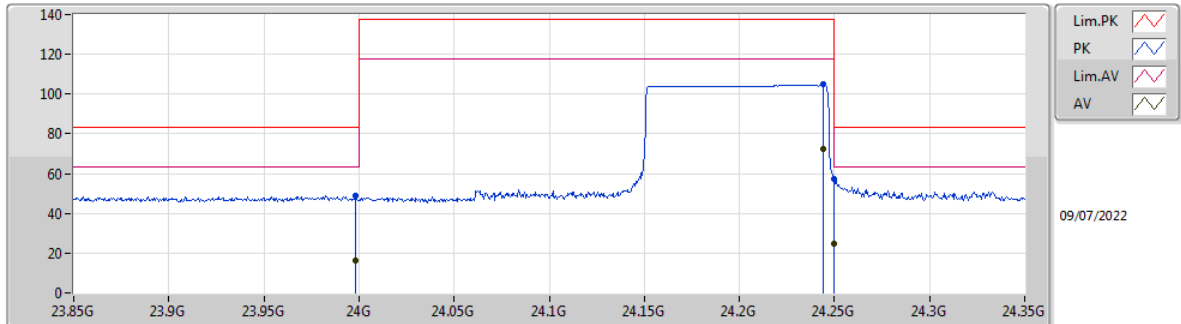

EUT X
Power DC 12V
05-M-N-2

Type	Freq (Hz)	Level (dBuV/m)	Limit (dBuV/m)	Margin (dB)	Factor (dB/m)	Dist (m)	Condition	Azimuth (°)	Height (m)	Comment	Raw (dBuV/m)	AF (dB/m)	CL (dB)	PA (dB)
PK	23.998G	48.98	83.54	-34.56	6.40	1	Horizontal	70	1.55	-	42.58	38.80	16.00	48.40
AV	23.998G	16.23	63.54	-47.31	6.40	1	Horizontal	70	1.55	-	9.83	38.80	16.00	48.40
PK	24.244G	104.88	137.54	-32.66	6.77	1	Horizontal	70	1.55	-	98.11	38.90	16.12	48.25
AV	24.244G	72.13	117.54	-45.41	6.77	1	Horizontal	70	1.55	-	65.36	38.90	16.12	48.25
PK	24.25G	57.20	83.54	-26.34	6.77	1	Horizontal	70	1.55	-	50.43	38.90	16.12	48.25
AV	24.25G	24.45	63.54	-39.09	6.77	1	Horizontal	70	1.55	-	17.68	38.90	16.12	48.25



Vertical

Mode 1

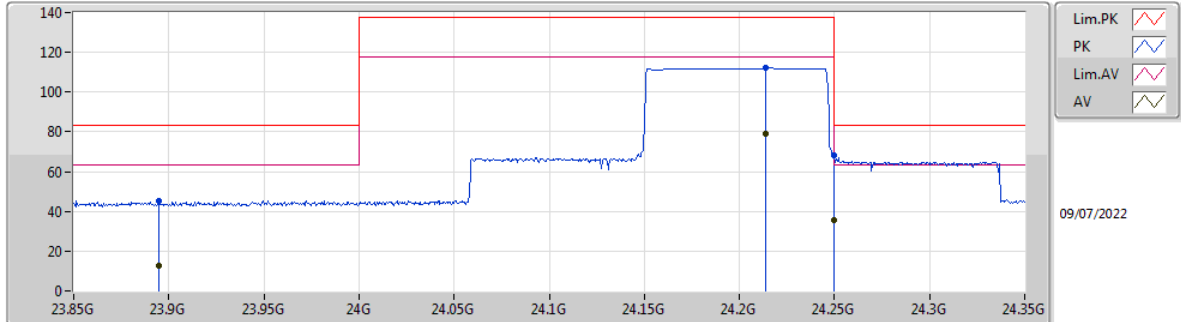

EUT X
Power DC 12V
05-M-N-2

Type	Freq (Hz)	Level (dBuV/m)	Limit (dBuV/m)	Margin (dB)	Factor (dB/m)	Dist (m)	Condition	Azimuth (°)	Height (m)	Comment	Raw (dBuV/m)	AF (dB/m)	CL (dB)	PA (dB)
PK	23.895G	45.47	83.54	-38.07	6.42	1	Vertical	1	1.51	-	39.05	38.84	15.98	48.40
AV	23.895G	12.72	63.54	-50.82	6.42	1	Vertical	1	1.51	-	6.30	38.84	15.98	48.40
PK	24.214G	111.95	137.54	-25.59	6.73	1	Vertical	1	1.51	-	105.22	38.89	16.11	48.27
AV	24.214G	79.20	117.54	-38.34	6.73	1	Vertical	1	1.51	-	72.47	38.89	16.11	48.27
PK	24.25G	68.09	83.54	-15.45	6.77	1	Vertical	1	1.51	-	61.32	38.90	16.12	48.25
AV	24.25G	35.34	63.54	-28.20	6.77	1	Vertical	1	1.51	-	28.57	38.90	16.12	48.25



2.2 20dB Spectrum Bandwidth Measurement

2.2.1 Limit

Intentional radiators must be designed to ensure that the 20 dB bandwidth of the emissions in the specific band (24000 ~ 24250 MHz).

2.2.2 Measuring Instruments and Setting

Refer a test equipment and calibration data table in this test report. The following table is the setting of the spectrum analyzer.

Spectrum Parameters	Setting
Attenuation	Auto
Span Frequency	> 20dB Bandwidth
RBW	100 kHz
VBW	100 kHz
Detector	Peak
Trace	Max Hold
Sweep Time	Auto

2.2.3 Test Procedures

1. The test procedure is the same as section 2.3.3.
2. The resolution bandwidth of 100 kHz and the video bandwidth of 100 kHz were used.
3. Measured the spectrum width with power higher than 20dB below carrier.

2.2.4 Test Setup Layout

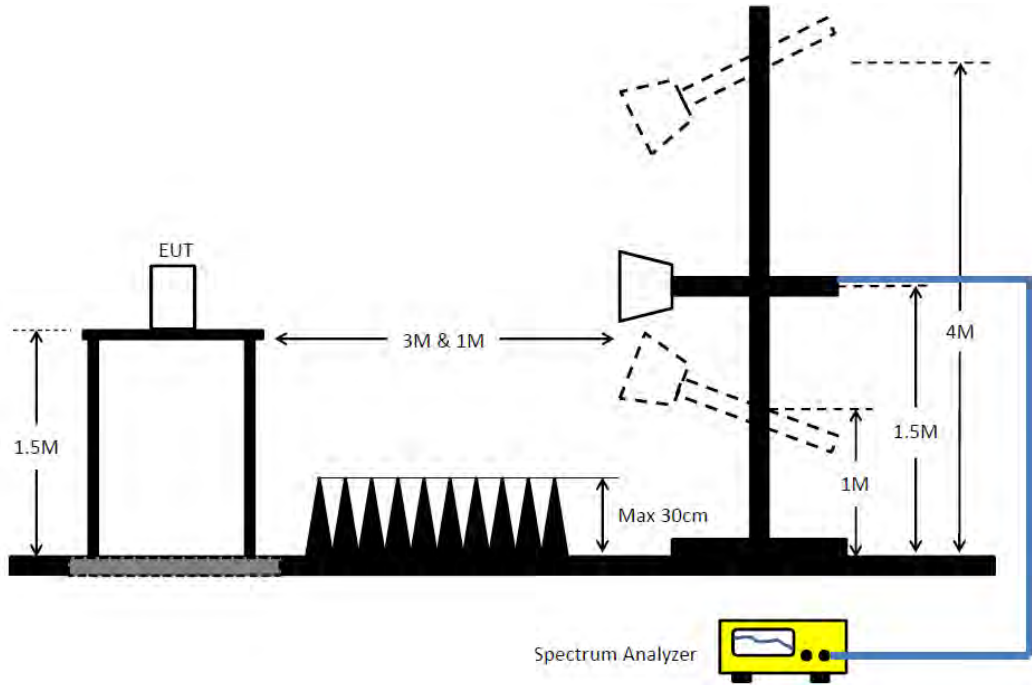

2.2.5 Test Deviation

There is no deviation with the original standard.

2.2.6 EUT Operation during Test

The EUT was programmed to be in continuously transmitting mode.



2.2.7 Test Result of 20dB Spectrum Bandwidth

Frequency	20dB BW (MHz)	99% OBW (MHz)	Frequency range (MHz) $f_L > 24000\text{MHz}$	Frequency range (MHz) $f_H < 24250\text{MHz}$	Test Result
24200 MHz	96.38	94.19	24149.89	24246.27	PASS

20 dB and 99% Bandwidth Plot on 24200 MHz

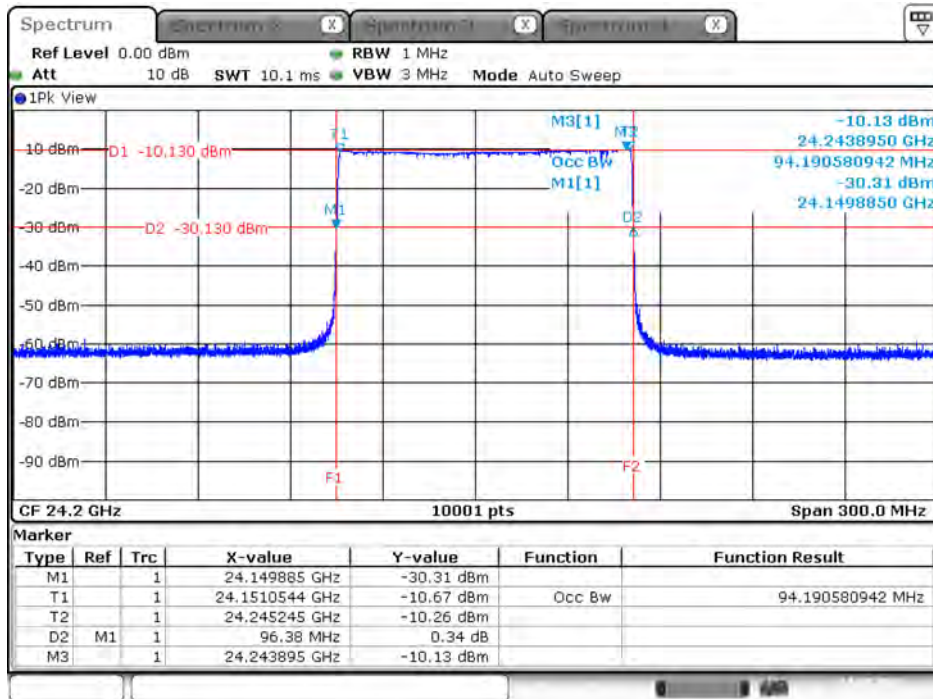

Date: 13.JUL.2022 11:17:56



2.3 Radiated Emissions Measurement

2.3.1 Limit

For 9kHz~40GHz

Harmonic emissions limits comply with below 54 dBuV/m at 3m. Other emissions radiated outside of the specified frequency bands, except for harmonics, shall be attenuated by at least 50 dB below the level of the fundamental or comply with the radiated emissions limits specified in section 15.209(a) limit in the table below has to be followed.

Frequencies (MHz)	Field Strength (micorvolts/meter)	Measurement Distance (meters)
0.009~0.490	2400/F(kHz)	300
0.490~1.705	24000/F(kHz)	30
1.705~30.0	30	30
30~88	100	3
88~216	150	3
216~960	200	3
Above 960	500	3

For 40GHz~100GHz

Emissions radiated outside of the specified frequency bands, except for harmonics, shall be attenuated by at least 50 dB below the level of the fundamental or to the general radiated emission limits in 47 CFR Part 15.249, whichever is the lesser attenuation.

Operating Frequencies	Harmonics Strength (micorvolts/meter)	Harmonics Strength (dBuV/m) at 3m
24000 ~ 24250 MHz	2500 at 3m	68 (Average)
24000 ~ 24250 MHz	2500 at 3m	88 (Peak)



2.3.2 Measuring Instruments and Setting

Refer a test equipment and calibration data table in this test report. The following table is the setting of the spectrum analyzer and receiver.

Spectrum Parameter	Setting
Attenuation	Auto
Start Frequency	1000 MHz
Stop Frequency	10th carrier harmonic
RBW / VBW	1MHz / 1MHz for Peak, 1 MHz / 1/T for Average

Receiver Parameter	Setting
Attenuation	Auto
Start ~ Stop Frequency	9kHz~150kHz / RBW 200Hz for QP
Start ~ Stop Frequency	150kHz~30MHz / RBW 9kHz for QP
Start ~ Stop Frequency	30MHz~1000MHz / RBW 120kHz for QP



2.3.3 Test Procedures

1. Configure the EUT according to ANSI C63.4. The EUT was placed on the top of the turntable 1.5 meter above ground. The phase center of the receiving antenna mounted on the top of a height-variable antenna tower was placed 3 meters far away from the turntable.
2. Power on the EUT and all the supporting units. The turntable was rotated by 360 degrees to determine the position of the highest radiation.
3. The height of the broadband receiving antenna was varied between one meter and four meters above ground to find the maximum emissions field strength of both horizontal and vertical polarization.
4. For each suspected emissions, the antenna tower was scan (from 1 M to 4 M) and then the turntable was rotated (from 0 degree to 360 degrees) to find the maximum reading.
5. Set the test-receiver system to Peak or CISPR quasi-peak Detect Function with specified bandwidth under Maximum Hold Mode.
6. For emissions above 1GHz, use 1MHz VBW and RBW for peak reading. Then 1MHz RBW and 1/T VBW for average reading in spectrum analyzer.
7. When the radiated emissions limits are expressed in terms of the average value of the emissions, and pulsed operation is employed, the measurement field strength shall be determined by averaging over one complete pulse train, including blanking intervals, as long as the pulse train does not exceed 0.1 seconds. As an alternative (provided the transmitter operates for longer than 0.1 seconds) or in cases where the pulse train exceeds 0.1 seconds, the measured field strength shall be determined from the average absolute voltage during a 0.1 second interval during which the field strength is at its maximum value.
8. If the emissions level of the EUT in peak mode was 3 dB lower than the average limit specified, then testing will be stopped and peak values of EUT will be reported, otherwise, the emissions which do not have 3 dB margin will be repeated one by one using the quasi-peak method for below 1GHz.
9. For testing above 1GHz, the emissions level of the EUT in peak mode was lower than average limit (that means the emissions level in peak mode also complies with the limit in average mode), then testing will be stopped and peak values of EUT will be reported, otherwise, the emissions will be measured in average mode again and reported.
10. In case the emission is lower than 30MHz, loop antenna has to be used for measurement and the recorded data should be QP measured by receiver. High – Low scan is not required in this case.

2.3.4 Test Setup Layout

For Radiated Emissions: 9kHz ~30MHz

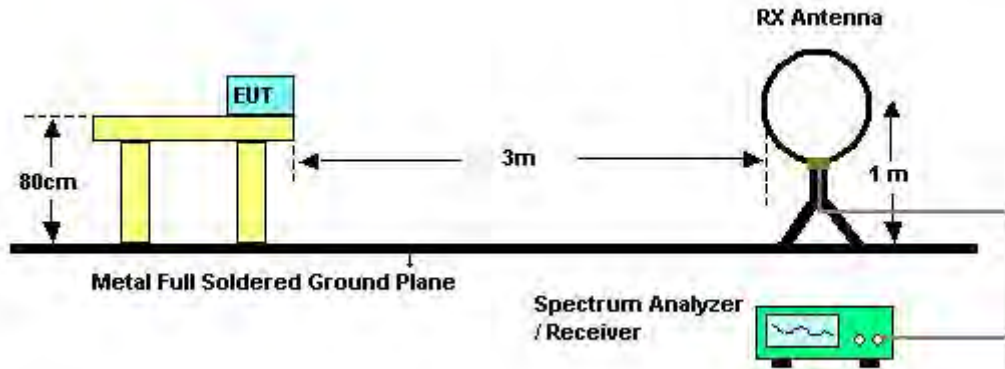

For Radiated Emissions: 30MHz~1GHz

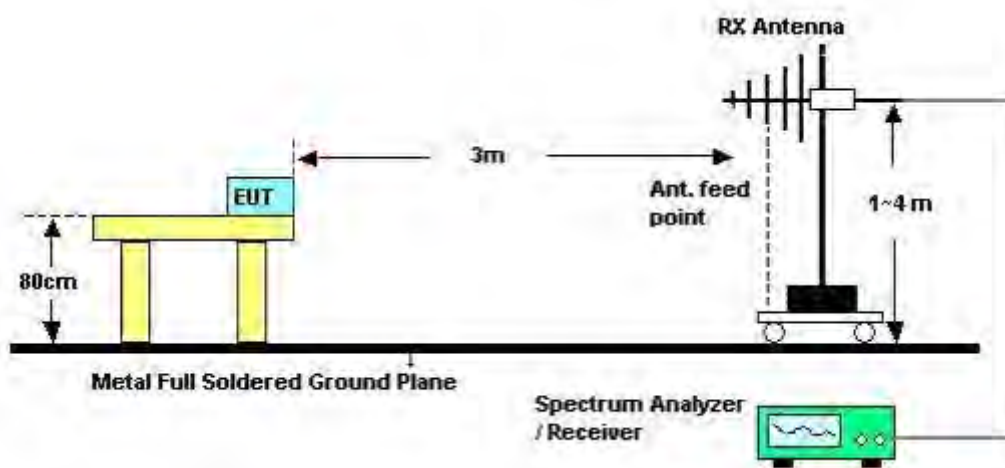

For radiated emissions: 1GHz~40GHz

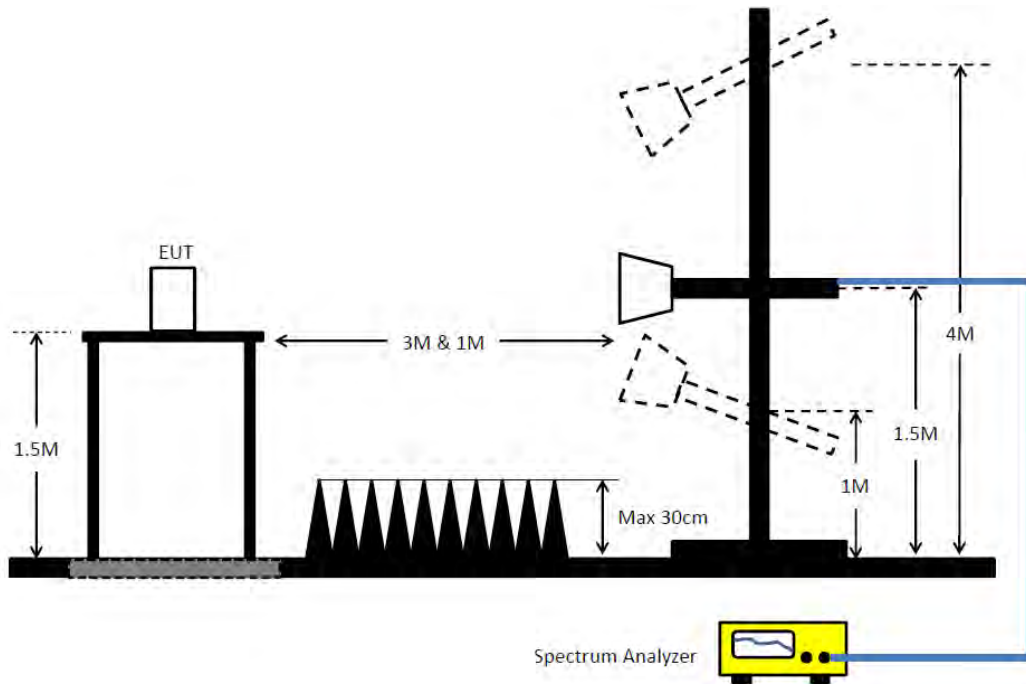

Above 10 GHz shall be extrapolated to the specified distance using an extrapolation factor of 20 dB/decade from 3m to 1m.

Distance extrapolation factor = $20 \log(\text{specific distance [3m]} / \text{test distance [1m]})$ (dB);

Limit line = specific limits (dBuV) + distance extrapolation factor [9.54 dB].

For radiated emissions: 40GHz~100GHz

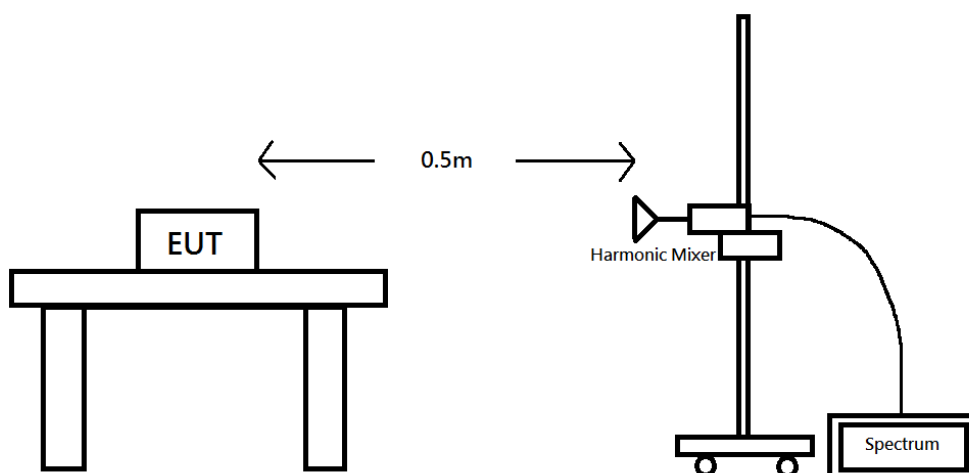



2.3.5 Test Deviation

There is no deviation with the original standard.

2.3.6 EUT Operation during Test

The EUT was programmed to be in continuously transmitting mode.

2.3.7 Measurement Results Calculation

The measured Level is calculated using:

For below 40GHz

Corrected Reading: Antenna factor (AF) + Cable loss (CL) + Read level (Raw) - Preamp factor (PA)(if applicable) = Level.

For above 40GHz

$EIRP = \text{Meas. Level} - \text{RX Antenna Gain} + 20 \cdot \log(4 \cdot \text{Pi} \cdot (3.14159) \cdot D / (300 / (\text{Frequency} \cdot 1000)))$



2.3.8 Results of Radiated Emissions (9kHz~30MHz)

Freq. (MHz)	Level (dBuV)	Over Limit (dB)	Limit Line (dBuV)	Remark
-	-	-	-	See Note

Note:

There is a comparison data of both open-field test site and alternative test site - semi-Anechoic chamber according to KDB414788 Radiated Test Site, and the result came out very similar.

The amplitude of spurious emissions which are attenuated by more than 20 dB below the permissible value has no need to be reported.

The radiated emissions were investigated from 9 kHz or the lowest frequency generated within the device, up to the 10 harmonic or 40 GHz, whichever is appropriate.

Distance extrapolation factor = $40 \log(\text{specific distance} / \text{test distance})$ (dB);

Limit line = specific limits (dBuV) + distance extrapolation factor.



2.3.9 Results of Radiated Emissions (30MHz~1GHz)

Horizontal

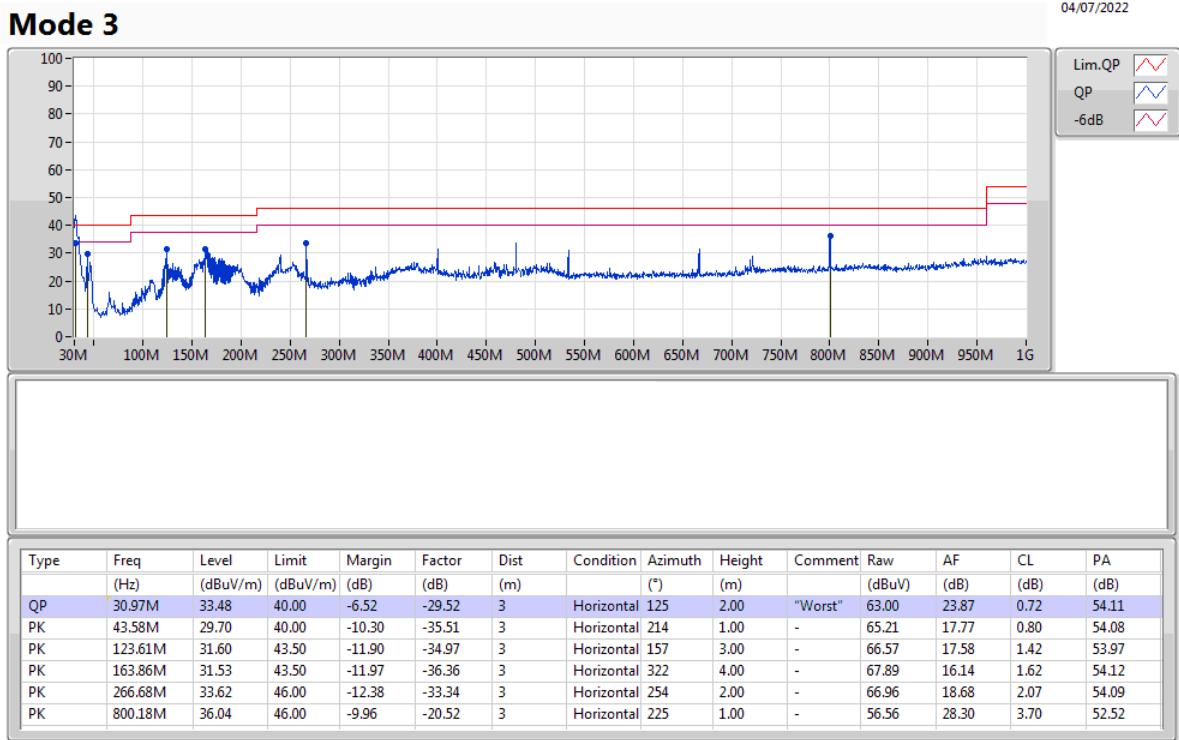



Vertical

Mode 3

04/07/2022

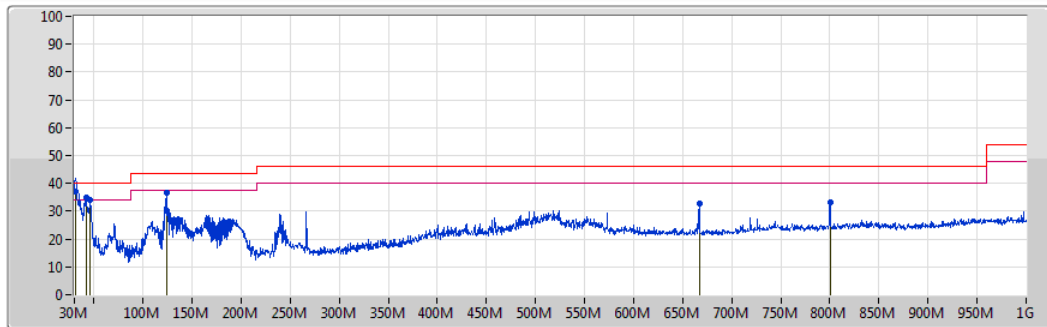

Type	Freq (Hz)	Level (dBuV/m)	Limit (dBuV/m)	Margin (dB)	Factor (dB)	Dist (m)	Condition	Azimuth (°)	Height (m)	Comment	Raw (dBuV)	AF (dB)	CL (dB)	PA (dB)
QP	30.97M	36.98	40.00	-3.02	-29.52	3	Vertical	125	1.00	"Worst"	66.50	23.87	0.72	54.11
PK	41.64M	34.83	40.00	-5.17	-34.54	3	Vertical	245	2.00	-	69.37	18.74	0.80	54.08
PK	46.49M	33.93	40.00	-6.07	-36.98	3	Vertical	121	1.00	-	70.91	16.27	0.83	54.08
PK	123.61M	36.68	43.50	-6.82	-34.97	3	Vertical	13	4.00	-	71.65	17.58	1.42	53.97
PK	666.81M	32.91	46.00	-13.09	-23.30	3	Vertical	258	3.00	-	56.21	26.59	3.23	53.12
PK	800.18M	33.38	46.00	-12.62	-20.52	3	Vertical	354	2.00	-	53.90	28.30	3.70	52.52

Note:

The amplitude of spurious emissions which are attenuated by more than 20dB below the permissible value has no need to be reported.

Emission level (dBuV/m) = 20 log Emission level (uV/m).



2.3.10 Results for Radiated Emissions (1GHz~40GHz)

Test Range	1 GHz ~ 18 GHz
-------------------	----------------

Horizontal

Mode 1

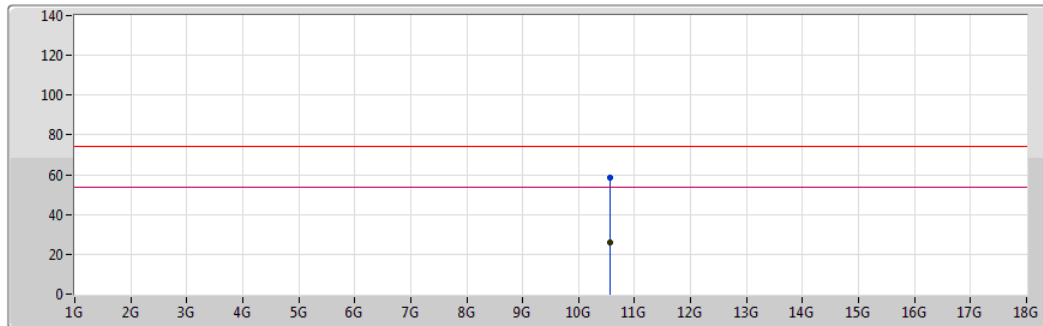

Lim.PK
 PK
 Lim.AV
 AV

09/07/2022

EUT X
Power DC 12V
05-F-B-4

Type	Freq (Hz)	Level (dBuV/m)	Limit (dBuV/m)	Margin (dB)	Factor (dB/m)	Dist (m)	Condition	Azimuth (°)	Height (m)	Comment	Raw (dBuV/m)	AF (dB/m)	CL (dB)	PA (dB)
PK	10.5608G	58.45	74.00	-15.55	14.32	3	Horizontal	358	1.80	-	44.13	39.16	8.85	33.69
AV	10.5608G	25.70	54.00	-28.30	14.32	3	Horizontal	358	1.80	-	11.38	39.16	8.85	33.69



Vertical

Mode 1

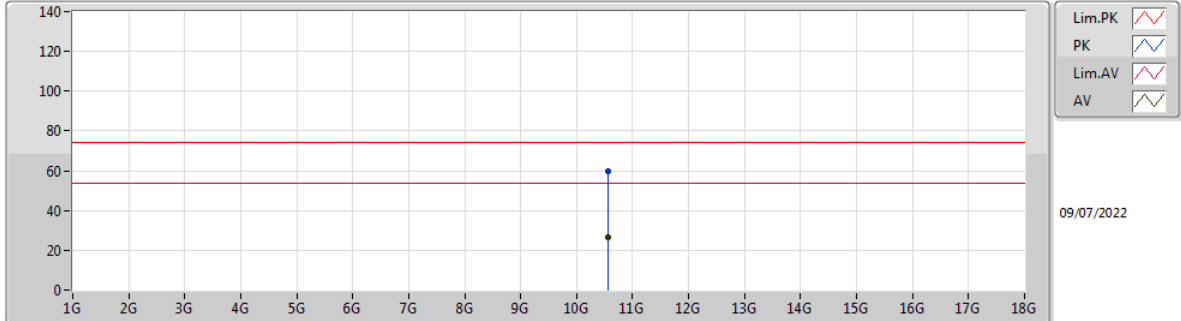

EUT X
Power DC 12V
05-F-B-4

Type	Freq (Hz)	Level (dBuV/m)	Limit (dBuV/m)	Margin (dB)	Factor (dB/m)	Dist (m)	Condition	Azimuth (*)	Height (m)	Comment	Raw (dBuV/m)	AF (dB/m)	CL (dB)	PA (dB)
PK	10.56006G	59.52	74.00	-14.48	14.32	3	Vertical	60	2.45	-	45.20	39.16	8.85	33.69
AV	10.56006G	26.77	54.00	-27.23	14.32	3	Vertical	60	2.45	-	12.45	39.16	8.85	33.69



Test Range	18 GHz ~ 40 GHz
-------------------	-----------------

Horizontal

Mode 1

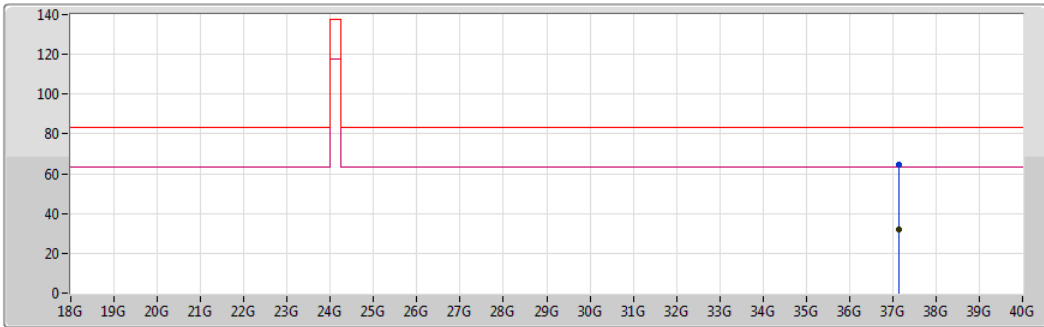

Lim.PK
 PK
 Lim.AV
 AV

09/07/2022

EUT X
Power DC 12V
05-F-B-4

Type	Freq (Hz)	Level (dBuV/m)	Limit (dBuV/m)	Margin (dB)	Factor (dB/m)	Dist (m)	Condition	Azimuth (°)	Height (m)	Comment	Raw (dBuV/m)	AF (dB/m)	CL (dB)	PA (dB)
PK	37.132G	64.79	83.54	-18.75	14.50	1	Horizontal	3	1.50	-	50.29	43.37	21.58	50.45
AV	37.132G	32.04	63.54	-31.50	14.50	1	Horizontal	3	1.50	-	17.54	43.37	21.58	50.45



Vertical

Mode 1

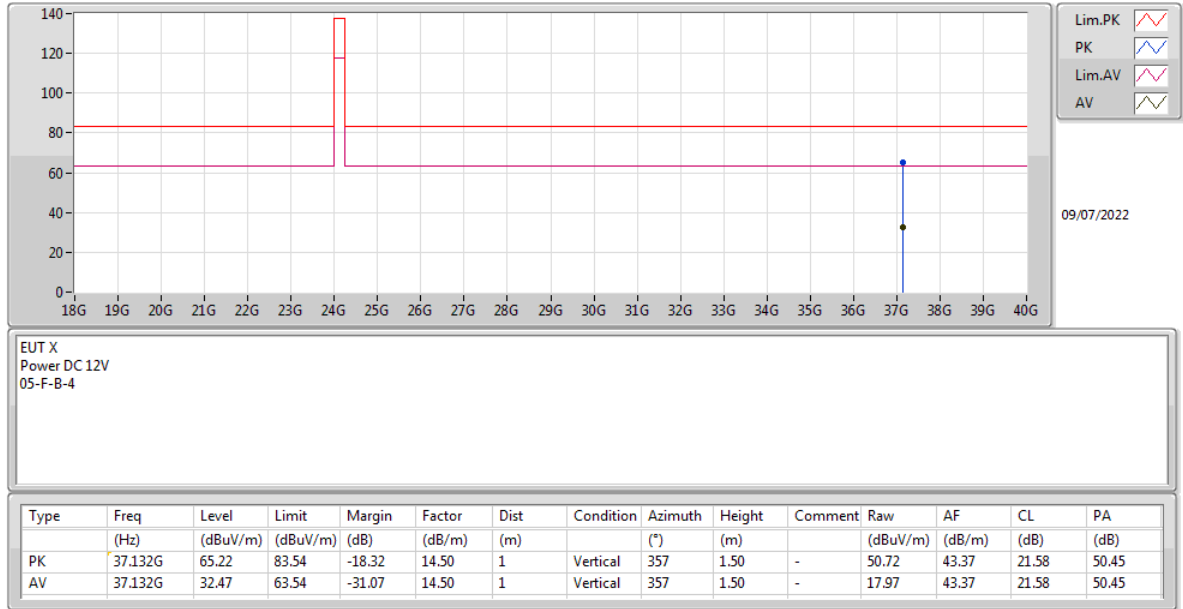

Note:

The amplitude of spurious emissions which are attenuated by more than 20dB below the permissible value has no need to be reported.

Emission level (dBuV/m) = 20 log Emission level (uV/m).



2.3.11 Results for Radiated Emissions (40GHz~100GHz)

Test Range	40~60G
-------------------	--------

Frequency (MHz)	Emission Freq. (GHz)	Meas. Distance (m)	Read Level (dBm)	Rx Antenna Gain (dBi)	Meas. Level (dBuV/m)	Limit (dBuV/m)	Margin (dB)	Remark	Result
24200	48.48	0.5	-77.80	23.9	69.27	103.52	-34.25	Peak	Pass
	48.48	0.5	-80.24	23.9	66.83	83.52	-16.69	Average	Pass

Test Range	60~90G
-------------------	--------

Frequency (MHz)	Emission Freq. (GHz)	Meas. Distance (m)	Read Level (dBm)	Rx Antenna Gain (dBi)	Meas. Level (dBuV/m)	Limit (dBuV/m)	Margin (dB)	Remark	Result
24200	72.62	0.5	-80.34	23.9	70.24	103.52	-33.28	Peak	Pass
	72.60	0.5	-85.47	23.9	65.11	83.52	-18.42	Average	Pass

Test Range	90~100G
-------------------	---------

Frequency (MHz)	Emission Freq. (GHz)	Meas. Distance (m)	Read Level (dBm)	Rx Antenna Gain (dBi)	Meas. Level (dBuV/m)	Limit (dBuV/m)	Margin (dB)	Remark	Result
24200	96.80	0.5	-77.64	23.5	75.84	103.52	-27.69	Peak	Pass
	96.79	0.5	-83.14	23.5	70.33	83.52	-13.19	Average	Pass

Distance extrapolation factor = 20 log (specific distance [3m] / test distance [0.5m]) (dB);

Limit line = specific limits (dBuV) + distance extrapolation factor [15.56 dB].

$EIRP = PT * GT = (PR / GR) * (4 * Pi * D / \lambda)^2$



2.4 Band Edge Emissions Measurement

2.4.1 Limit

Band edge emissions radiated outside of the specified frequency bands shall be attenuated by at least 50 dB below the level of the fundamental or comply with the radiated emissions limits specified in section 15.209(a) limit in the table below has to be followed.

Frequencies (MHz)	Field Strength (microvolts/meter)	Measurement Distance (meters)
0.009~0.490	2400/F(kHz)	300
0.490~1.705	24000/F(kHz)	30
1.705~30.0	30	30
30~88	100	3
88~216	150	3
216~960	200	3
Above 960	500	3

2.4.2 Measuring Instruments and Setting

Refer a test equipment and calibration data table in this test report. The following table is the setting of the spectrum analyzer.

Spectrum Parameter	Setting
Attenuation	Auto
Span Frequency	100 MHz
RBW / VBW	1MHz / 1MHz for Peak, 1 MHz / 1/T for Average

2.4.3 Test Procedures

The test procedure is the same as section 2.3.3.

2.4.4 Test Setup Layout

This test setup layout is the same as that shown in section 2.3.4

2.4.5 Test Deviation

There is no deviation with the original standard.

2.4.6 EUT Operation during Test

The EUT was programmed to be in continuously transmitting mode.



2.4.7 Measurement Results Calculation

The measured Level is calculated using:

Corrected Reading: Antenna factor (AF) + Cable loss (CL) + Read level (Raw) - Preamp factor (PA)(if applicable) = Level.



2.4.8 Test Result of Band Edge and Fundamental Emissions

Horizontal

Mode 1

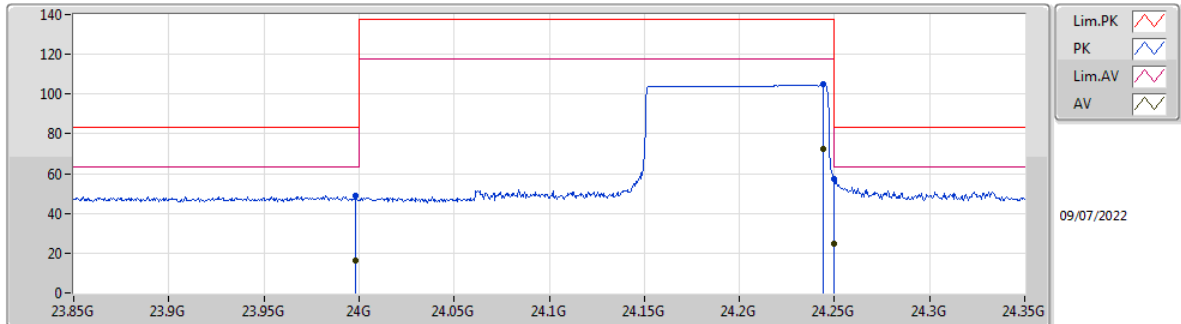

EUT X
Power DC 12V
05-M-N-2

Type	Freq (Hz)	Level (dBuV/m)	Limit (dBuV/m)	Margin (dB)	Factor (dB/m)	Dist (m)	Condition	Azimuth (°)	Height (m)	Comment	Raw (dBuV/m)	AF (dB/m)	CL (dB)	PA (dB)
PK	23.998G	48.98	83.54	-34.56	6.40	1	Horizontal	70	1.55	-	42.58	38.80	16.00	48.40
AV	23.998G	16.23	63.54	-47.31	6.40	1	Horizontal	70	1.55	-	9.83	38.80	16.00	48.40
PK	24.244G	104.88	137.54	-32.66	6.77	1	Horizontal	70	1.55	-	98.11	38.90	16.12	48.25
AV	24.244G	72.13	117.54	-45.41	6.77	1	Horizontal	70	1.55	-	65.36	38.90	16.12	48.25
PK	24.25G	57.20	83.54	-26.34	6.77	1	Horizontal	70	1.55	-	50.43	38.90	16.12	48.25
AV	24.25G	24.45	63.54	-39.09	6.77	1	Horizontal	70	1.55	-	17.68	38.90	16.12	48.25



Vertical

Mode 1

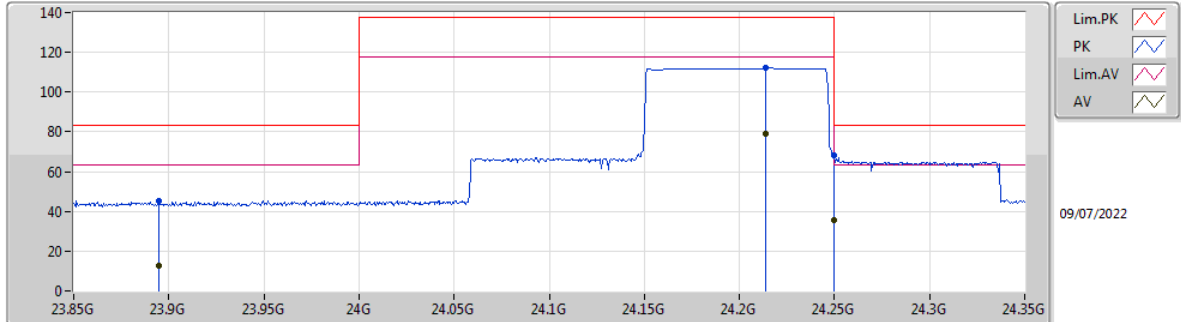

EUT X
Power DC 12V
05-M-N-2

Type	Freq (Hz)	Level (dBuV/m)	Limit (dBuV/m)	Margin (dB)	Factor (dB/m)	Dist (m)	Condition	Azimuth (°)	Height (m)	Comment	Raw (dBuV/m)	AF (dB/m)	CL (dB)	PA (dB)
PK	23.895G	45.47	83.54	-38.07	6.42	1	Vertical	1	1.51	-	39.05	38.84	15.98	48.40
AV	23.895G	12.72	63.54	-50.82	6.42	1	Vertical	1	1.51	-	6.30	38.84	15.98	48.40
PK	24.214G	111.95	137.54	-25.59	6.73	1	Vertical	1	1.51	-	105.22	38.89	16.11	48.27
AV	24.214G	79.20	117.54	-38.34	6.73	1	Vertical	1	1.51	-	72.47	38.89	16.11	48.27
PK	24.25G	68.09	83.54	-15.45	6.77	1	Vertical	1	1.51	-	61.32	38.90	16.12	48.25
AV	24.25G	35.34	63.54	-28.20	6.77	1	Vertical	1	1.51	-	28.57	38.90	16.12	48.25



2.5 Antenna Requirements

2.5.1 Limit

Except for special regulations, the Low-power Radio-frequency Devices must not be equipped with any jacket for installing an antenna with extension cable. An intentional radiator shall be designed to ensure that no antenna other than that furnished by the responsible party shall be used with the device. The use of a permanently attached antenna or of an antenna that uses a unique coupling to the intentional radiator shall be considered sufficient to comply with the provisions of this Section. The manufacturer may design the unit so that the user can replace a broken antenna, but the use of a standard antenna jack or electrical connector is prohibited.

2.5.2 Antenna Connector Construction

The antenna connector complied with the requirements.



3 List of Measuring Equipments

Instrument	Brand	Model No.	Serial No.	Characteristics	Calibration Date	Calibration Due Date	Remark
10m Semi Anechoic Chamber NSA	TDK	SAC-10M	10CH01-CB	30MHz~1GHz 10m,3m	Jan. 27, 2022	Jan. 26, 2023	Radiation (10CH01-CB)
Amplifier	Agilent	8447D	2944A10783	9kHz ~ 1.3GHz	Mar. 11, 2022	Mar. 10, 2023	Radiation (10CH01-CB)
Amplifier	Agilent	8447D	2944A10784	9kHz ~ 1.3GHz	Mar. 11, 2022	Mar. 10, 2023	Radiation (10CH01-CB)
Low Cable	Woken	SUCOFLEX 104	low cable-01	25MHz ~ 1GHz	Oct. 19, 2021	Oct. 18, 2022	Radiation (10CH01-CB)
Low Cable	Woken	SUCOFLEX 104	low cable-02	25MHz ~ 1GHz	Oct. 19, 2021	Oct. 18, 2022	Radiation (10CH01-CB)
EMI Receiver	Agilent	N9038A	MY52260140	9kHz ~ 8.4GHz	May 06, 2022	May 05, 2023	Radiation (10CH01-CB)
Spectrum Analyzer	Rohde&Schwarz	FSV30	101026	9kHz ~ 30GHz	Apr. 22, 2022	Apr. 21, 2023	Radiation (10CH01-CB)
Bilog Antenna with 6dB Attenuator	Chase & EMCI	CBL6111A &N-6-06	1543 &AT-N0609	30MHz ~ 1GHz	Jun. 25, 2022	Jun. 24, 2023	Radiation (10CH01-CB)
Amplifier	EM	EM101	060703	10MHz ~ 1GHz	Oct. 20, 2021	Oct. 19, 2022	Radiation (10CH01-CB)
Low Cable	TITAN	T318E	low cable-03	30MHz ~ 1GHz	Jun. 17, 2022	Jun. 16, 2023	Radiation (10CH01-CB)
Software	SPORTON	SENSE	V5.10	-	N.C.R.	N.C.R.	Radiation (10CH01-CB)
Loop Antenna	Teseq	HLA 6120	24155	9kHz - 30 MHz	May 14, 2022	May 13, 2023	Radiation (10CH01-CB)
3m Semi Anechoic Chamber VSWR	TDK	SAC-3M	03CH05-CB	1GHz ~18GHz 3m	Nov. 07, 2021	Nov. 06, 2022	Radiation (03CH05-CB)
Horn Antenna	SCHWARZBECK	BBHA9120D	BBHA 9120 D-1291	1GHz~18GHz	Jun. 23, 2022	Jun. 22, 2023	Radiation (03CH05-CB)
Horn Antenna	Schwarzbeck	BBHA 9170	BBHA9170252	15GHz ~ 40GHz	Aug. 05, 2021	Aug. 04, 2022	Radiation (03CH05-CB)
Pre-Amplifier	EMCI	EMC12630SE	980287	1GHz – 26.5GHz	Jul. 01, 2022	Jun. 30, 2023	Radiation (03CH05-CB)
Pre-Amplifier	MITEQ	TTA1840-35-HG	1864479	18GHz ~ 40GHz	Jul. 13, 2021	Jul. 12, 2022	Radiation (03CH05-CB)
Spectrum Analyzer	R&S	FSP40	100304	9kHz ~ 40GHz	Mar. 14, 2022	Mar. 13, 2023	Radiation (03CH05-CB)
RF Cable-high	Woken	RG402	High Cable-28	1GHz~18GHz	Oct. 13, 2021	Oct. 12, 2022	Radiation (03CH05-CB)
RF Cable-high	Woken	RG402	High Cable-04+28	1GHz~18GHz	Oct. 13, 2021	Oct. 12, 2022	Radiation (03CH05-CB)



Instrument	Brand	Model No.	Serial No.	Characteristics	Calibration Date	Calibration Due Date	Remark
High Cable	Woken	WCA0929M	40G#5+7	1GHz ~ 40 GHz	Dec. 14, 2021	Dec. 13, 2022	Radiation (03CH05-CB)
High Cable	Woken	WCA0929M	40G#5	1GHz ~ 40 GHz	Dec. 08, 2021	Dec. 07, 2022	Radiation (03CH05-CB)
High Cable	Woken	WCA0929M	40G#7	1GHz ~ 40 GHz	Dec. 14, 2021	Dec. 13, 2022	Radiation (03CH05-CB)
Test Software	SPORTON	SENSE	V5.10	-	N.C.R.	N.C.R.	Radiation (03CH05-CB)
Mixer	OML	M19HWA	U91113-1	40 ~ 60 GHz	Mar. 10, 2022	Mar. 09, 2023	Radiation (03CH05-CB)
*Mixer	OML	M12HWA	E91113-1	60 ~ 90 GHz	Nov. 14, 2020	Nov. 13, 2022	Radiation (03CH05-CB)
Mixer	OML	M08HWA	F91113-1	90 ~ 140 GHz	Mar. 10, 2022	Mar. 09, 2023	Radiation (03CH05-CB)
Standard Horn Antenna	Custom Microwave	M19RH	U91113-A	40 ~ 60 GHz	N.C.R.	N.C.R.	Radiation (03CH05-CB)
Standard Horn Antenna	Custom Microwave	M12RH	E91113-A	60 ~ 90 GHz	N.C.R.	N.C.R.	Radiation (03CH05-CB)
Standard Horn Antenna	Custom Microwave	M08RH	F91113-A	90 ~ 140 GHz	N.C.R.	N.C.R.	Radiation (03CH05-CB)

Note: Calibration Interval of instruments listed above is one year.

* Calibration Interval of instruments listed above is two year.

N.C.R. means Non-Calibration required.



4 Measurement Uncertainty

Test Items	Uncertainty	Remark
Radiated Emission (9kHz ~ 30MHz)	3.4 dB	Confidence levels of 95%
Radiated Emission (30MHz ~ 1,000MHz)	5.6 dB	Confidence levels of 95%
Radiated Emission (1GHz ~ 18GHz)	5.2 dB	Confidence levels of 95%
Radiated Emission (18GHz ~ 40GHz)	4.7 dB	Confidence levels of 95%
Radiated Emission (40GHz ~ 60GHz)	3.0 dB	Confidence levels of 95%
Radiated Emission (60GHz ~ 90GHz)	3.2 dB	Confidence levels of 95%
Radiated Emission (90GHz ~ 200GHz)	4.3 dB	Confidence levels of 95%