



**中认信通**  
CHINA CERTIFICATION ICT CO., LTD. (DONGGUAN)



## TEST REPORT

**Applicant: Shenzhen Ysair Technology Co., LTD**

Address: Room 403, 4th Floor, Building 4, Yunli intelligent park, No.3  
Changfa Middle Road, Yangmei community, Bantian street,  
Longgang District, Shenzhen, Guangdong China

**FCC ID: 2A3OORT628S**

**Product Name: Two Way Radio**

**Standard(s): 47 CFR Part 95 Subpart B  
ANSI C63.26-2015  
ANSI/TIA 603-E-2016**

The above equipment has been tested and found compliant with the requirement of the relative standards by China Certification ICT Co., Ltd (Dongguan)

**Report Number: CR230846428-00**

**Date Of Issue: 2023/9/14**

**Reviewed By: Julie Tan**

Title: RF Engineer

*Julie Tan*

**Approved By: Sun Zhong**

Title: Manager

*Sun Zhong*

**Test Laboratory: China Certification ICT Co., Ltd (Dongguan)**

No. 113, Pingkang Road, Dalang Town, Dongguan,  
Guangdong, China  
Tel: +86-769-82016888

## Test Facility

The Test site used by China Certification ICT Co., Ltd (Dongguan) to collect test data is located on the No. 113, Pingkang Road, Dalang Town, Dongguan, Guangdong, China.

The lab has been recognized as the FCC accredited lab under the KDB 974614 D01 and is listed in the FCC Public Access Link (PAL) database, FCC Registration No. : 442868, the FCC Designation No. : CN1314.

The lab has been recognized by Innovation, Science and Economic Development Canada to test to Canadian radio equipment requirements, the CAB identifier: CN0123.

## Declarations

China Certification ICT Co., Ltd (Dongguan) is not responsible for the authenticity of any test data provided by the applicant. Data included from the applicant that may affect test results are marked with a triangle symbol “▲”. Customer model name, addresses, names, trademarks etc. are not considered data.

Unless otherwise stated the results shown in this test report refer only to the sample(s) tested.

This report cannot be reproduced except in full, without prior written approval of the Company.

This report is valid only with a valid digital signature. The digital signature may be available only under the Adobe software above version 7.0.

This report may contain data that are not covered by the accreditation scope and shall be marked with an asterisk “★”.

## CONTENTS

<b>TEST FACILITY .....</b>	<b>2</b>
<b>DECLARATIONS.....</b>	<b>2</b>
<b>DOCUMENT REVISION HISTORY .....</b>	<b>5</b>
<b>1. GENERAL INFORMATION.....</b>	<b>6</b>
<b>1.1 PRODUCT DESCRIPTION FOR EQUIPMENT UNDER TEST (EUT) .....</b>	<b>6</b>
<b>1.2 DESCRIPTION OF TEST CONFIGURATION.....</b>	<b>7</b>
1.2.1 EUT Operation Condition:.....	7
1.2.2 Support Equipment List and Details .....	7
1.2.3 Support Cable List and Details .....	7
1.2.4 Block Diagram of Test Setup.....	7
<b>1.3 MEASUREMENT UNCERTAINTY .....</b>	<b>8</b>
<b>2. SUMMARY OF TEST RESULTS .....</b>	<b>9</b>
<b>3. REQUIREMENTS AND TEST PROCEDURES .....</b>	<b>10</b>
<b>3.1 FRS FREQUENCY ACCURACY .....</b>	<b>10</b>
3.1.1 Applicable Standard.....	10
3.1.2 EUT Setup Block Diagram .....	10
3.1.3 Test Procedure .....	10
<b>3.2 FRS TRANSMIT POWER.....</b>	<b>11</b>
3.2.1 Applicable Standard.....	11
3.2.2 EUT Setup Block Diagram .....	11
3.2.3 Test Procedure .....	11
<b>3.3 FRS EMISSION TYPES.....</b>	<b>12</b>
3.3.1 Applicable Standard.....	12
3.3.2 Judgment.....	12
<b>3.4 FRS AUTHORIZED BANDWIDTH .....</b>	<b>13</b>
3.4.1 Applicable Standard.....	13
3.4.2 EUT Setup Block Diagram .....	13
3.4.3 Test Procedure .....	13
<b>3.5 FRS MODULATION LIMITS .....</b>	<b>14</b>
3.5.1 Applicable Standard.....	14
3.5.2 EUT Setup Block Diagram .....	14
3.5.3 Test Procedure .....	14
<b>3.6 FRS UNWANTED EMISSIONS LIMITS.....</b>	<b>16</b>
3.6.1 Applicable Standard.....	16
3.6.2 Test setup:.....	17
3.6.3 Test Procedure: .....	18
<b>3.7 FRS ADDITIONAL REQUIREMENTS .....</b>	<b>19</b>
3.7.1 Applicable Standard.....	19
3.7.2 Judgment.....	19
<b>4. TEST DATA AND RESULTS .....</b>	<b>20</b>

---

<b>4.1 FRS FREQUENCY ACCURACY .....</b>	<b>20</b>
<b>4.2 FRS TRANSMIT POWER.....</b>	<b>22</b>
<b>4.3 FRS AUTHORIZED BANDWIDTH AND EMISSION MASK .....</b>	<b>24</b>
<b>4.4 FRS MODULATION LIMITS .....</b>	<b>26</b>
<b>4.5 RADIATED SPURIOUS EMISSION .....</b>	<b>30</b>
<b>5. EUT PHOTOGRAPHS .....</b>	<b>32</b>
<b>6. TEST SETUP PHOTOGRAPHS .....</b>	<b>33</b>

---

## DOCUMENT REVISION HISTORY

---

Revision Number	Report Number	Description of Revision	Date of Revision
1.0	CR230846428-00	Original Report	2023/9/14

## 1. GENERAL INFORMATION

### 1.1 Product Description for Equipment under Test (EUT)

<b>EUT Name:</b>	Two Way Radio
<b>EUT Model:</b>	RT628S
<b>Channel Spacing:</b>	12.5kHz
<b>Emission Designator:</b>	11K0F3E
<b>Maximum Output Power: (ERP)</b>	462.5500-462.7250MHz: 23.75 dBm 467.5625-467.7125MHz: 24.07 dBm
<b>Rated Input Voltage:</b>	DC4.5V from battery
<b>Serial Number:</b>	29CG-1
<b>EUT Received Date:</b>	2023/8/14
<b>EUT Received Status:</b>	Good

### Operation Frequency Detail:

Channel Number	Frequency (MHz)	Channel Number	Frequency (MHz)
1	462.5625	12	467.6625
2	462.5875	13	467.6875
3	462.6125	14	467.7125
4	<b>462.6375</b>	15	462.5500
5	462.6625	16	462.5750
6	462.6875	17	462.6000
7	462.7125	18	462.6250
8	467.5625	19	462.6500
9	467.5875	20	462.6750
10	467.6125	21	462.7000
11	<b>467.6375</b>	22	462.7250

Per C63.26-2015, section 5.1, the frequency in bold was performed the test.

### Antenna Information Detail▲:

Antenna Manufacturer	Antenna Connector	Antenna Type	input impedance (Ohm)	Antenna Gain /Frequency Range
Auctus Technologies Ltd.	integral	Monopole	50	0 dBi(-2.15dBd) 400-470MHz

### Accessory Information:

Accessory Description	Manufacturer	Model	Parameters
/	/	/	/

## 1.2 Description of Test Configuration

### 1.2.1 EUT Operation Condition:

<b>EUT Operation Mode:</b>	The system was configured for testing in Engineering Mode, which was provided by the manufacturer.
<b>Equipment Modifications:</b>	No
<b>EUT Exercise Software:</b>	No

### 1.2.2 Support Equipment List and Details

Manufacturer	Description	Model	Serial Number
\	\	\	\

### 1.2.3 Support Cable List and Details

Cable Description	Shielding Type	Ferrite Core	Length (m)	From Port	To
\	\	\	\	\	\

### 1.2.4 Block Diagram of Test Setup

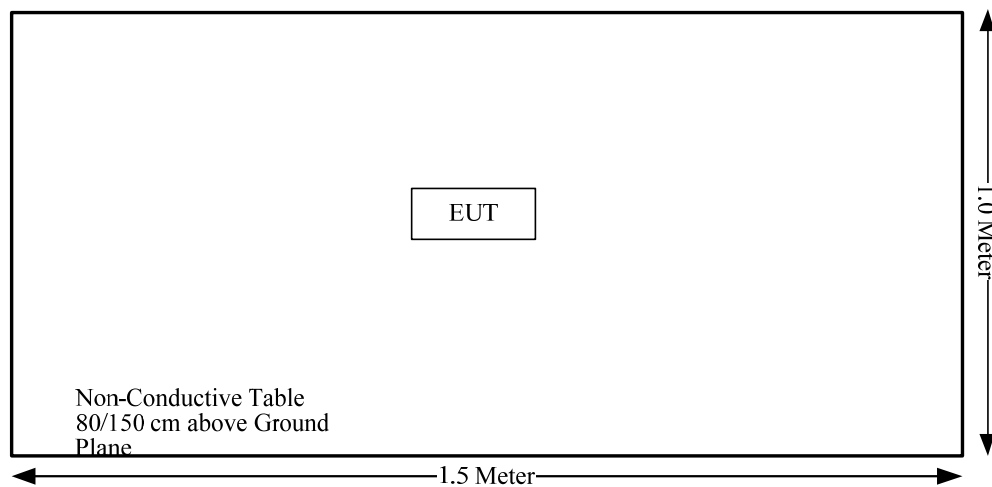

### 1.3 Measurement Uncertainty

Otherwise required by the applicant or Product Regulations, Decision Rule in this report did not consider the uncertainty. The extended uncertainty given in this report is obtained by combining the standard uncertainty times the coverage factor K with the 95% confidence interval.

Parameter	Measurement Uncertainty
Occupied Channel Bandwidth	±5 %
RF output power, conducted	±0.61dB
Unwanted Emissions, radiated	30M~200MHz: 4.15 dB, 200M~1GHz: 5.61 dB, 1G~6GHz: 5.14 dB, 6G~18GHz: 5.93 dB, 18G~26.5G: 5.47 dB, 26.5G~40G: 5.63 dB
Unwanted Emissions, conducted	±1.26 dB
Temperature	±1 °C
Humidity	±5%
DC and low frequency voltages	±0.4%
Duty Cycle	1%
RF Frequency	±0.082×10 <sup>-6</sup>
Audio Frequency/Low Pass Filter Response	4.02%
Modulation Limiting	1.19%



## 2. SUMMARY OF TEST RESULTS

Description of Test	Standard/Rule(s)	Results
FRS Frequency Accuracy	§2.1055(d), §95.565	Compliant
FRS transmit Power	FCC§2.1046, FCC§95.567	Compliant
FRS Emission Types	§95.571	Compliant
FRS Authorized Bandwidth	§2.1049, §95.573	Compliant
Emission Mask	§95.579	Compliant
FRS Modulation Limits	§2.1047, §95.575	Compliant
FRS Unwanted Emissions Limits	§2.1053, §95.579	Compliant
FRS Additional Requirements	§95.587	Compliant

## 3. REQUIREMENTS AND TEST PROCEDURES

### 3.1 FRS Frequency Accuracy

#### 3.1.1 Applicable Standard

FCC §95.565

Each FRS transmitter type must be designed such that the carrier frequencies remain within  $\pm 2.5$  parts-per-million of the channel center frequencies specified in § 95.563 during normal operating conditions.

#### 3.1.2 EUT Setup Block Diagram

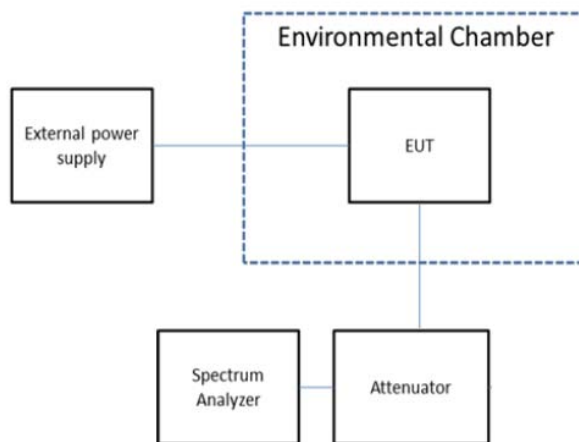

#### 3.1.3 Test Procedure

C63.26-2015, Clause 5.6

Frequency stability is a measure of the frequency drift due to temperature and supply voltage variations, with reference to the frequency measured at +20 °C and rated supply voltage. The operating carrier frequency shall be set up in accordance with the manufacturer's published operation and instruction manual prior to the commencement of these tests. No adjustment of any frequency determining circuit element shall be made subsequent to this initial set-up. Frequency stability is tested:

a) At 10 °C intervals of temperatures between -30 °C and +50 °C at the manufacturer's rated supply voltage, and

b) At +20 °C temperature and  $\pm 15\%$  supply voltage variations. If a product is specified to operate over a range of input voltage then the -15% variation is applied to the lowermost voltage and the +15% is applied to the uppermost voltage. During the test all necessary settings, adjustments and control of the EUT have to be performed without disturbing the test environment, i.e., without opening the environmental chamber. The frequency stabilities can be maintained to a lesser temperature range provided that the transmitter is automatically inhibited from operating outside the lesser temperature range. For handheld equipment that is only capable of operating from internal batteries and the supply voltage cannot be varied, the frequency stability tests shall be performed at the nominal battery voltage and the battery end point voltage specified by the manufacturer. An external supply voltage can be used and set at the internal battery nominal voltage, and again at the battery operating end point voltage which shall be specified by the equipment manufacturer.

If an unmodulated carrier is not available, the mean frequency of a modulated carrier can be obtained by using a frequency counter with gating time set to an appropriately large multiple of bit periods (gating time depending on the required accuracy). Full details on the choice of values shall be included in the test report.

## 3.2 FRS Transmit Power

### 3.2.1 Applicable Standard

FCC §95.567

Each FRS transmitter type must be designed such that the effective radiated power (ERP) on channels 8 through 14 does not exceed 0.5 Watts and the ERP on channels 1 through 7 and 15 through 22 does not exceed 2.0 Watts.

### 3.2.2 EUT Setup Block Diagram

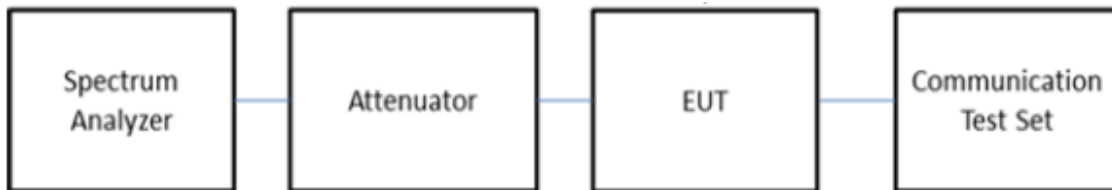

Note: The insertion loss of the RF cable, Coaxial Attenuators, DC Block was offset into the Spectrum Analyzer.

### 3.2.3 Test Procedure

C63.26-2015, Clause 5.2.3.3

This procedure can be used to measure the peak power in either a CW-like or noise-like narrowband RF signal. The measurement instrument must have a RBW that is greater than or equal to the OBW of the signal to be measured and a VBW  $\geq 3 \times$  RBW.

- a) Set the RBW  $\geq$  OBW.
- b) Set VBW  $\geq 3 \times$  RBW.
- c) Set span  $\geq 2 \times$  OBW.
- d) Sweep time  $\geq 10 \times$  (number of points in sweep)  $\times$  (transmission symbol period).
- e) Detector = peak.
- f) Trace mode = max hold.
- g) Allow trace to fully stabilize.
- h) Use the peak marker function to determine the peak amplitude level

### **3.3 FRS Emission Types**

#### **3.3.1 Applicable Standard**

FCC §95.571

Each FRS transmitter type must be designed such that it can transmit only the following emission types: F3E, G3E, F2D, and G2D.

#### **3.3.2 Judgment**

Emission type is F3E.

### 3.4 FRS Authorized Bandwidth

#### 3.4.1 Applicable Standard

FCC §95.573

Each FRS transmitter type must be designed such that the occupied bandwidth does not exceed 12.5 kHz.

#### 3.4.2 EUT Setup Block Diagram

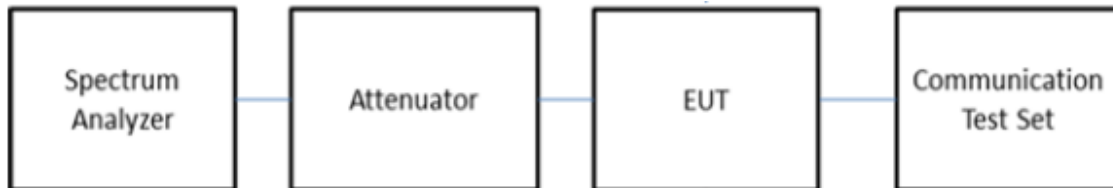

Note: The insertion loss of the RF cable, Coaxial Attenuators, DC Block was offset into the Spectrum Analyzer.

#### 3.4.3 Test Procedure

C63.26-2015, Clause 5.4.4

The OBW is the frequency bandwidth such that, below its lower and above its upper frequency limits, the mean powers are each equal to 0.5% of the total mean power of the given emission.

The following procedure shall be used for measuring (99%) power bandwidth:

- a) The spectrum analyzer center frequency is set to the nominal EUT channel center frequency. The frequency span for the spectrum analyzer shall be set wide enough to capture all modulation products including the emission skirts (typically a span of  $1.5 \times \text{OBW}$  is sufficient).
- b) The nominal IF filter 3 dB bandwidth (RBW) shall be in the range of 1% to 5% of the anticipated OBW, and the VBW shall be set  $\geq 3 \times \text{RBW}$ .
- c) Set the reference level of the instrument as required to prevent the signal amplitude from exceeding the maximum spectrum analyzer input mixer level for linear operation. See guidance provided in 4.2.3.  
NOTE—Step a), step b), and step c) may require iteration to adjust within the specified tolerances.
- d) Set the detection mode to peak, and the trace mode to max-hold.
- e) If the instrument does not have a 99% OBW function, recover the trace data points and sum directly in linear power terms. Place the recovered amplitude data points, beginning at the lowest frequency, in a running sum until 0.5% of the total is reached. Record that frequency as the lower OBW frequency. Repeat the process until 99.5% of the total is reached and record that frequency as the upper OBW frequency. The 99% power OBW can be determined by computing the difference these two frequencies.
- f) The OBW shall be reported and plot(s) of the measuring instrument display shall be provided with the test report. The frequency and amplitude axis and scale shall be clearly labeled. Tabular data can be reported in addition to the plot(s).

### 3.5 FRS Modulation Limits

#### 3.5.1 Applicable Standard

FCC §95.575

Each FRS transmitter type must be designed such that the peak frequency deviation does not exceed 2.5 kHz, and the highest audio frequency contributing substantially to modulation must not exceed 3.125 kHz.

#### 3.5.2 EUT Setup Block Diagram

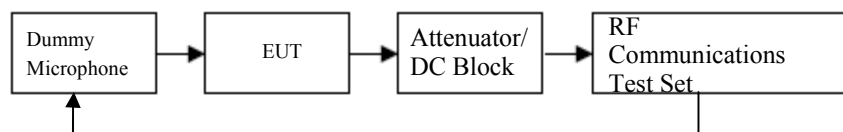

**Modulation limiting Test and Audio frequency response Test**

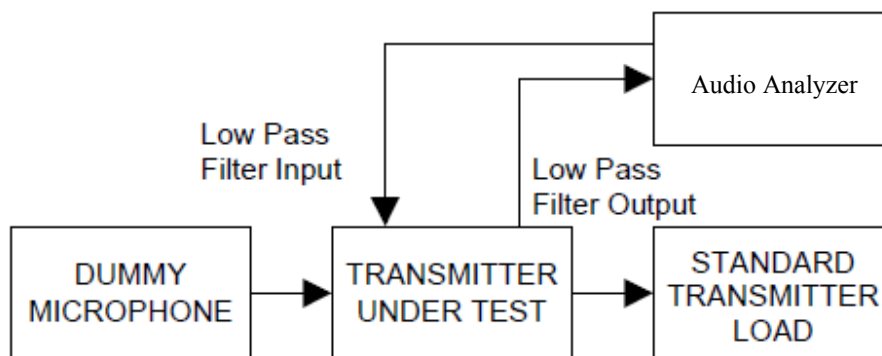

**Audio Low Pass Filter Response Test**

#### 3.5.3 Test Procedure

##### C63.26-2015, Clause 5.3.2 Modulation limiting test methodology

Modulation limiting is the ability of a transmitter circuit to limit the transmitter from producing deviations in excess of a rated system deviation.

- Connect the equipment as illustrated in Figure 1.
- Adjust the transmitter per the manufacturer's procedure for full rated system deviation.
- Set the test receiver to measure peak positive deviation. Set the audio bandwidth for  $\leq 0.25$  Hz to  $\geq 15000$  Hz. Turn the de-emphasis function off.
- Apply a 1000 Hz modulating signal to the transmitter from the audio frequency generator, and adjust the level to obtain 60% of full rated system deviation. This is the 0 dB reference level.
- Increase the level from the audio generator by 20 dB in 5 dB increments recording the deviation as measured from the test receiver in each step. Verify that the audio level used to make the OBW measurement is included in the sweep.
- Repeat for step e) at 300 Hz, 2500 Hz and 3000 Hz at a minimum using the 0 dB reference level obtained in step d).

- g) Set the test receiver to measure peak negative deviation and repeat step d) through step f).
- h) The values recorded in step f) and step g) are the modulation limiting.
- i) Plot the data set as a percentage of deviation relative to the 0 dB reference point versus input voltage.

**C63.26-2015, Clause 5.3.3.2 Audio frequency response test methodology—Constant Input**

- a) Connect the equipment as illustrated in Figure 3.
- b) Set the test receiver to measure peak positive deviation. Set the audio bandwidth for  $\leq 50$  Hz to  $\geq 15\ 000$  Hz. Turn the de-emphasis function off.
- c) Adjust the transmitter per the manufacturer's procedure for full rated system deviation.
- d) Apply a 1000 Hz tone and adjust the audio frequency generator to produce 20% of the rated system deviation.
- e) Set the test receiver to measure rms deviation and record the deviation reading as  $DEV_{REF}$ .
- f) Set the audio frequency generator to the desired test frequency between 300 Hz and 3000 Hz.

**ANSI/TIA-603-E-2016, Clause 2.2.15 Audio Low Pass Filter Response**

- a) Connect the equipment as illustrated.
- b) Connect the Audio Generator as close as possible the input of the post limiter low pass filter within the transmitter under test.
- c) Connect the RF Communications Test Set to the output of the post limiter low pass filter within the transmitter under test.
- d) Apply a 1000 Hz tone from the audio frequency generator and adjust the level per manufacturer's specifications.
- e) Record the dB level of the 1000 Hz spectral line on the RF Communications Test Set as  $LEV_{REF}$ .
- f) Set the audio frequency generator to the desired test frequency between 3000 Hz and the upper low pass filter limit.
- g) Record RF Communications Test Set levels, at the test frequency in step f).
- h) Record the dB level on the RF Communications Test Set as  $LEV_{FREQ}$ .

### 3.6 FRS Unwanted Emissions Limits

#### 3.6.1 Applicable Standard

FCC §95.579

Each FRS transmitter type must be designed to satisfy the applicable unwanted emissions limits in this paragraph.

(a) *Attenuation requirements.* The power of unwanted emissions must be attenuated below the carrier power output in Watts (P) by at least:

(1) 25 dB (decibels) in the frequency band 6.25 kHz to 12.5 kHz removed from the channel center frequency.

(2) 35 dB in the frequency band 12.5 kHz to 31.25 kHz removed from the channel center frequency.

(3)  $43 + 10 \log (P)$  dB in any frequency band removed from the channel center frequency by more than 31.25 kHz.

(b) *Measurement bandwidths.* The power of unwanted emissions in the frequency bands specified in paragraphs (a)(1) and (2) of this section is measured with a reference bandwidth of 300 Hz. The power of unwanted emissions in the frequency range specified in paragraph (a)(3) is measured with a reference bandwidth of at least 30 kHz.

(c) *Measurement conditions.* The requirements in this section apply to each FRS transmitter type both with and without the connection of permitted attachments, such as an external speaker, microphone and/or power cord.



**3.6.2 Test setup:**

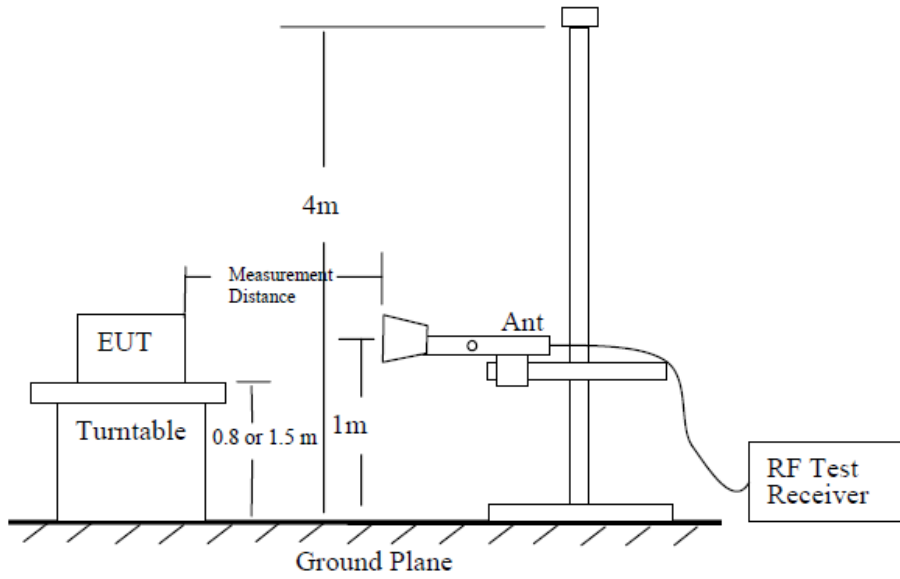

**Figure 6—Test site-up for radiated ERP and/or EIRP measurements**

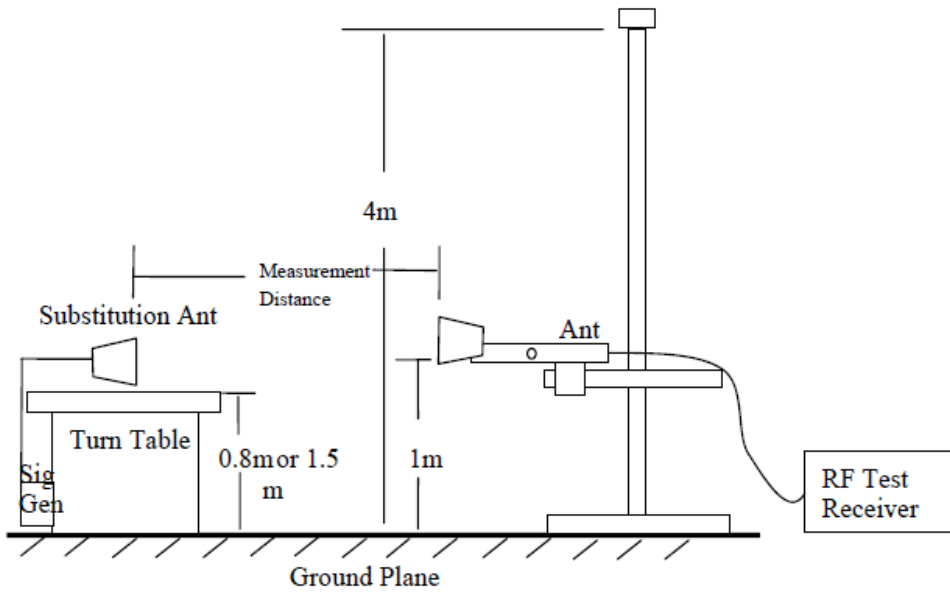

**Figure 7—Substitution method set-up for radiated emission**

### 3.6.3 Test Procedure:

#### ANSI C63.26-2015 Section 5.5.3

- a) Place the EUT in the center of the turntable. The EUT shall be configured to transmit into the standard non-radiating load (for measuring radiated spurious emissions), connected with cables of minimal length unless specified otherwise. If the EUT uses an adjustable antenna, the antenna shall be positioned to the length that produces the worst case emission at the fundamental operating frequency.
- b) Each emission under consideration shall be evaluated:
  - 1) Raise and lower the measurement antenna in accordance 5.5.2, as necessary to enable detection of the maximum emission amplitude relative to measurement antenna height.
  - 2) Rotate the EUT through 360° to determine the maximum emission level relative to the axial position.
  - 3) Return the turntable to the azimuth where the highest emission amplitude level was observed.
  - 4) Vary the measurement antenna height again through 1 m to 4 m again to find the height associated with the maximum emission amplitude.
  - 5) Record the measured emission amplitude level and frequency using the appropriate RBW.
- c) Repeat step b) for each emission frequency with the measurement antenna oriented in both the horizontal and vertical polarizations to determine the orientation that gives the maximum emissions amplitude.
- d) Set-up the substitution measurement with the reference point of the substitution antenna located as near as possible to where the center of the EUT radiating element was located during the initial EUT measurement.
- e) Maintain the previous measurement instrument settings and test set-up, with the exception that the EUT is removed and replaced by the substitution antenna.
- f) Connect a signal generator to the substitution antenna; locate the signal generator so as to minimize any potential influences on the measurement results. Set the signal generator to the frequency where emissions are detected, and set an output power level such that the radiated signal can be detected by the measurement instrument, with sufficient dynamic range relative to the noise floor.
- g) For each emission that was detected and measured in the initial test [i.e., in step b) and step c)]:
  - 1) Vary the measurement antenna height between 1 m to 4 m to maximize the received (measured) signal amplitude.
  - 2) Adjust the signal generator output power level until the amplitude detected by the measurement instrument equals the amplitude level of the emission previously measured directly in step b) and step c).
  - 3) Record the output power level of the signal generator when equivalence is achieved in step 2).
- h) Repeat step e) through step g) with the measurement antenna oriented in the opposite polarization.
- i) Calculate the emission power in dBm referenced to a half-wave dipole using the following equation:
 
$$P_e = P_s(\text{dBm}) - \text{cable loss (dB)} + \text{antenna gain (dBd)}$$
 where
  - $P_e$  = equivalent emission power in dBm
  - $P_s$  = source (signal generator) power in dBm
 NOTE—dBd refers to the measured antenna gain in decibels relative to a half-wave dipole.
- j) Correct the antenna gain of the substitution antenna if necessary to reference the emission power to a half-wave dipole. When using measurement antennas with the gain specified in dBi, the equivalent dipole-referenced gain can be determined from:  $\text{gain (dBd)} = \text{gain (dBi)} - 2.15 \text{ dB}$ . If necessary, the antenna gain can be calculated from calibrated antenna factor information
- k) Provide the complete measurement results as a part of the test report.

### 3.7 FRS Additional Requirements

#### 3.7.1 Applicable Standard

FCC §95.587

Each FRS transmitter type must be designed to meet the following additional requirements.

(a) *Transmit frequency capability.* FRS transmitter types must not be capable of transmitting on any frequency or channel other than those listed in § 95.563.

(b) *Antenna.* The antenna of each FRS transmitter type must meet the following requirements.

(1) The antenna must be a non-removable integral part of the FRS transmitter type.

(2) The gain of the antenna must not exceed that of a half-wave dipole antenna.

(3) The antenna must be designed such that the electric field of the emitted waves is vertically polarized when the unit is operated in the normal orientation.

(c) *Digital data transmissions.* FRS transmitter types having the capability to transmit digital data must be designed to meet the following requirements.

(1) FRS units may transmit digital data containing location information, or requesting location information from one or more other FRS or GMRS units, or containing a brief text message to another specific FRS or GMRS unit or units.

(2) Digital data transmissions may be initiated by a manual action or command of the operator or on an automatic or periodic basis, and FRS units may be designed to automatically respond with location data upon receiving an interrogation request from another

(3) Digital data transmissions must not exceed one second in duration.

(4) Digital data transmissions must not be sent more frequently than one digital data transmission within a thirty-second period, except that an FRS unit may automatically respond to more than one interrogation request received within a thirty-second period.

(d) *Packet mode.* FRS transmitter types must not be capable of transmitting data in the store-and-forward packet operation mode.

(e) Effective September 30, 2019, no person shall manufacture or import hand-held portable radio equipment capable of operating under this subpart (FRS) and other licensed or licensed-by-rule services in this chapter (part 15 unlicensed equipment authorizations are permitted if consistent with part 15 rules).

#### 3.7.2 Judgment

Transmit frequency capability: Compliance, please refer to section 1.1.

Antenna: Compliant, please refer to section 1.1.

Digital Data transmissions: Not Applicable, no digital modulation function.

Packet mode: Not Applicable, no digital modulation function.

No capable of FRS combined other licensed: Compliance, Only FRS function

**Result: Compliant.**

## 4. TEST DATA AND RESULTS

### 4.1 FRS Frequency Accuracy

Serial Number:	29CG-1	Test Date:	2023/8/20
Test Site:	RF	Test Mode:	Transmitting
Tester:	Morpheus Shi	Test Result:	Pass

#### Environmental Conditions:

Temperature: (°C)	27.7	Relative Humidity: (%)	64	ATM Pressure: (kPa)	99.9
----------------------	------	------------------------------	----	------------------------	------

#### Test Equipment List and Details:

Manufacturer	Description	Model	Serial Number	Calibration Date	Calibration Due Date
R&S	Spectrum Analyzer	FSV40	101943	2023/3/31	2024/3/30
zhuoxiang	Coaxial Cable	SMA-178	211001	Each time	N/A
Mini-Circuits	DC Block	BLK-18-S+	1554403	Each time	N/A
eastsheep	Coaxial Attenuator	2W-SMA-JK-18G	21060301	Each time	N/A
Weinschel	Coaxial Attenuator	53-20-34	LN751	Each time	N/A
BACL	TEMP&HUMI Test Chamber	BTH-150-40	30174	2023/3/31	2024/3/30
UNI-T	Multimeter	UT39A+	C210582554	2022/9/29	2023/9/28
ZHAOXIN	DC Power Supply	RXN-6010D	21R6010D0912386	N/A	N/A

\* Statement of Traceability: China Certification ICT Co., Ltd (Dongguan) attests that all calibrations have been performed, traceable to National Primary Standards and International System of Units (SI).

**Test Data:**

Test Frequency (MHz)	Temperature (°C)	Voltage (Vdc)	Measured Frequency (MHz)	Frequency Error (ppm)	limit (ppm)
462.6375	-30	4.5	462.6375891	0.19	≤2.5
	-20	4.5	462.6375453	0.10	≤2.5
	-10	4.5	462.6375006	0.00	≤2.5
	0	4.5	462.6374537	-0.10	≤2.5
	10	4.5	462.6373992	-0.22	≤2.5
	20	4.5	462.6373550	-0.31	≤2.5
	30	4.5	462.6373064	-0.42	≤2.5
	40	4.5	462.6372488	-0.54	≤2.5
	50	4.5	462.6372015	-0.65	≤2.5
	20	3.6	462.6374215	-0.17	≤2.5
	20	4.8	462.6373550	-0.31	≤2.5

Test Frequency (MHz)	Temperature (°C)	Voltage (Vdc)	Measured Frequency (MHz)	Frequency Error (ppm)	limit (ppm)
467.6375	-30	4.5	467.6375925	0.20	≤2.5
	-20	4.5	467.6375514	0.11	≤2.5
	-10	4.5	467.6375103	0.02	≤2.5
	0	4.5	467.6374568	-0.09	≤2.5
	10	4.5	467.6374001	-0.21	≤2.5
	20	4.5	467.6373550	-0.31	≤2.5
	30	4.5	467.6373147	-0.40	≤2.5
	40	4.5	467.6372576	-0.52	≤2.5
	50	4.5	467.6372139	-0.61	≤2.5
	20	3.6	467.6374302	-0.15	≤2.5
	20	4.8	467.6373550	-0.31	≤2.5

**4.2 FRS Transmit Power**

Serial Number:	29CG-1	Test Date:	2023/8/20
Test Site:	RF	Test Mode:	Transmitting
Tester:	Morpheus Shi	Test Result:	Pass

**Environmental Conditions:**

Temperature: (°C)	27.7	Relative Humidity: (%)	64	ATM Pressure: (kPa)	99.9
----------------------	------	------------------------------	----	------------------------	------

**Test Equipment List and Details:**

Manufacturer	Description	Model	Serial Number	Calibration Date	Calibration Due Date
R&S	Spectrum Analyzer	FSV40	101943	2023/3/31	2024/3/30
zhuoxiang	Coaxial Cable	SMA-178	211001	Each time	N/A
Mini-Circuits	DC Block	BLK-18-S+	1554403	Each time	N/A
eastsheep	Coaxial Attenuator	2W-SMA-JK-18G	21060301	Each time	N/A
Weinschel	Coaxial Attenuator	53-20-34	LN751	Each time	N/A
HP	RF Communications Test Set	8920A	3438A05209	2023/3/31	2024/3/30

\* Statement of Traceability: China Certification ICT Co., Ltd (Dongguan) attests that all calibrations have been performed, traceable to National Primary Standards and International System of Units (SI).

**Test Data:**

Test Frequency (MHz)	Conducted Output power (dBm)	Antenna Gain (dBd)	ERP (dBm)	ERP Limit (dBm)
462.6375	25.90	-2.15	23.75	≤33
467.6375	26.22	-2.15	24.07	≤27
ERP=Conducted Output Power + Antenna Gain(dBd)				

### Conducted Output power

462.6375 MHz

467.6375 MHz

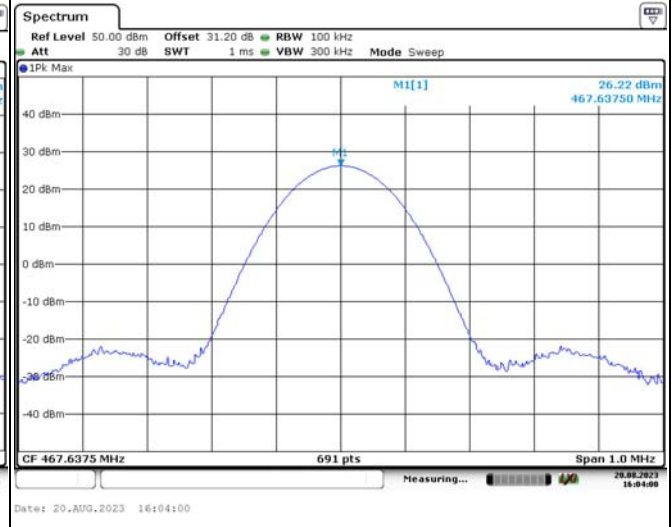
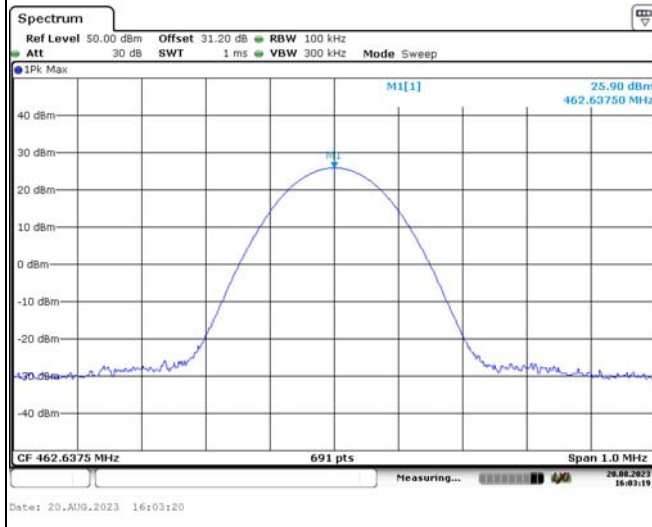

### 4.3 FRS Authorized Bandwidth And Emission Mask

Serial Number:	29CG-1	Test Date:	2023/9/14
Test Site:	RF	Test Mode:	Transmitting
Tester:	Morpheus Shi	Test Result:	Pass

#### Environmental Conditions:

Temperature: (°C)	27.7	Relative Humidity: (%)	64	ATM Pressure: (kPa)	99.9
----------------------	------	------------------------------	----	------------------------	------

#### Test Equipment List and Details:

Manufacturer	Description	Model	Serial Number	Calibration Date	Calibration Due Date
R&S	Spectrum Analyzer	FSV40	101943	2023/3/31	2024/3/30
zhuoxiang	Coaxial Cable	SMA-178	211001	Each time	N/A
Mini-Circuits	DC Block	BLK-18-S+	1554403	Each time	N/A
eastsheep	Coaxial Attenuator	2W-SMA-JK-18G	21060301	Each time	N/A
Weinschel	Coaxial Attenuator	53-20-34	LN751	Each time	N/A
HP	RF Communications Test Set	8920A	3438A05209	2023/3/31	2024/3/30

\* Statement of Traceability: China Certification ICT Co., Ltd (Dongguan) attests that all calibrations have been performed, traceable to National Primary Standards and International System of Units (SI).

#### Test Data:

Test Frequency (MHz)	99% Occupied Bandwidth (kHz)	Limit (kHz)
462.6375	5.355	≤12.5
467.6375	5.355	≤12.5

Note:

Emission bandwidth was based on calculation method instead of measurement.

Emission Designator

Per CFR 47 §2.201& §2.202,  $BW = 2M + 2D$

**For FM Mode (Channel Spacing: 12.5 kHz)**

Emission Designator 11K0F3E

In this case, the maximum modulating frequency is 3.0 kHz with a 2.5 kHz deviation.

$BW = 2(M+D) = 2*(3.0 \text{ kHz} + 2.5 \text{ kHz}) = 11 \text{ kHz} = 11K0$

F3E portion of the designator represents an FM voice transmission

Therefore, the entire designator for 12.5 kHz channel spacing FM mode is 11K0F3E.



Test Items	99% Occupied Bandwidth	Emission Mask																																																																						
462.6375 MHz	<table border="1"> <thead> <tr> <th>Type</th> <th>Ref</th> <th>Trc</th> <th>X-value</th> <th>Y-value</th> <th>Function</th> <th>Function Result</th> </tr> </thead> <tbody> <tr> <td>M1</td> <td>1</td> <td></td> <td>462.63475 MHz</td> <td>1.82 dBm</td> <td></td> <td></td> </tr> <tr> <td>T1</td> <td>1</td> <td></td> <td>462.63475 MHz</td> <td>1.82 dBm</td> <td>Occ Bw</td> <td>5.354558611 kHz</td> </tr> <tr> <td>T2</td> <td>1</td> <td></td> <td>462.640105 MHz</td> <td>3.56 dBm</td> <td></td> <td></td> </tr> <tr> <td>D1</td> <td>M1</td> <td>1</td> <td>5.5 kHz</td> <td>-21.16 dB</td> <td></td> <td></td> </tr> </tbody> </table>	Type	Ref	Trc	X-value	Y-value	Function	Function Result	M1	1		462.63475 MHz	1.82 dBm			T1	1		462.63475 MHz	1.82 dBm	Occ Bw	5.354558611 kHz	T2	1		462.640105 MHz	3.56 dBm			D1	M1	1	5.5 kHz	-21.16 dB			<table border="1"> <thead> <tr> <th>Type</th> <th>Ref</th> <th>Trc</th> <th>X-value</th> <th>Y-value</th> <th>Function</th> <th>Function Result</th> </tr> </thead> <tbody> <tr> <td>M1</td> <td>1</td> <td></td> <td>462.63475 MHz</td> <td>1.82 dBm</td> <td></td> <td></td> </tr> <tr> <td>T1</td> <td>1</td> <td></td> <td>462.63475 MHz</td> <td>1.82 dBm</td> <td>Occ Bw</td> <td>5.354558611 kHz</td> </tr> <tr> <td>T2</td> <td>1</td> <td></td> <td>462.640105 MHz</td> <td>3.56 dBm</td> <td></td> <td></td> </tr> <tr> <td>D1</td> <td>M1</td> <td>1</td> <td>5.5 kHz</td> <td>-21.16 dB</td> <td></td> <td></td> </tr> </tbody> </table>	Type	Ref	Trc	X-value	Y-value	Function	Function Result	M1	1		462.63475 MHz	1.82 dBm			T1	1		462.63475 MHz	1.82 dBm	Occ Bw	5.354558611 kHz	T2	1		462.640105 MHz	3.56 dBm			D1	M1	1	5.5 kHz	-21.16 dB		
Type	Ref	Trc	X-value	Y-value	Function	Function Result																																																																		
M1	1		462.63475 MHz	1.82 dBm																																																																				
T1	1		462.63475 MHz	1.82 dBm	Occ Bw	5.354558611 kHz																																																																		
T2	1		462.640105 MHz	3.56 dBm																																																																				
D1	M1	1	5.5 kHz	-21.16 dB																																																																				
Type	Ref	Trc	X-value	Y-value	Function	Function Result																																																																		
M1	1		462.63475 MHz	1.82 dBm																																																																				
T1	1		462.63475 MHz	1.82 dBm	Occ Bw	5.354558611 kHz																																																																		
T2	1		462.640105 MHz	3.56 dBm																																																																				
D1	M1	1	5.5 kHz	-21.16 dB																																																																				
467.6375 MHz	<table border="1"> <thead> <tr> <th>Type</th> <th>Ref</th> <th>Trc</th> <th>X-value</th> <th>Y-value</th> <th>Function</th> <th>Function Result</th> </tr> </thead> <tbody> <tr> <td>M1</td> <td>1</td> <td></td> <td>467.63475 MHz</td> <td>0.48 dBm</td> <td></td> <td></td> </tr> <tr> <td>T1</td> <td>1</td> <td></td> <td>467.63475 MHz</td> <td>0.48 dBm</td> <td>Occ Bw</td> <td>5.354558611 kHz</td> </tr> <tr> <td>T2</td> <td>1</td> <td></td> <td>467.640105 MHz</td> <td>3.24 dBm</td> <td></td> <td></td> </tr> <tr> <td>D1</td> <td>M1</td> <td>1</td> <td>5.355 kHz</td> <td>2.76 dB</td> <td></td> <td></td> </tr> </tbody> </table>	Type	Ref	Trc	X-value	Y-value	Function	Function Result	M1	1		467.63475 MHz	0.48 dBm			T1	1		467.63475 MHz	0.48 dBm	Occ Bw	5.354558611 kHz	T2	1		467.640105 MHz	3.24 dBm			D1	M1	1	5.355 kHz	2.76 dB			<table border="1"> <thead> <tr> <th>Type</th> <th>Ref</th> <th>Trc</th> <th>X-value</th> <th>Y-value</th> <th>Function</th> <th>Function Result</th> </tr> </thead> <tbody> <tr> <td>M1</td> <td>1</td> <td></td> <td>467.63475 MHz</td> <td>0.48 dBm</td> <td></td> <td></td> </tr> <tr> <td>T1</td> <td>1</td> <td></td> <td>467.63475 MHz</td> <td>0.48 dBm</td> <td>Occ Bw</td> <td>5.354558611 kHz</td> </tr> <tr> <td>T2</td> <td>1</td> <td></td> <td>467.640105 MHz</td> <td>3.24 dBm</td> <td></td> <td></td> </tr> <tr> <td>D1</td> <td>M1</td> <td>1</td> <td>5.355 kHz</td> <td>2.76 dB</td> <td></td> <td></td> </tr> </tbody> </table>	Type	Ref	Trc	X-value	Y-value	Function	Function Result	M1	1		467.63475 MHz	0.48 dBm			T1	1		467.63475 MHz	0.48 dBm	Occ Bw	5.354558611 kHz	T2	1		467.640105 MHz	3.24 dBm			D1	M1	1	5.355 kHz	2.76 dB		
Type	Ref	Trc	X-value	Y-value	Function	Function Result																																																																		
M1	1		467.63475 MHz	0.48 dBm																																																																				
T1	1		467.63475 MHz	0.48 dBm	Occ Bw	5.354558611 kHz																																																																		
T2	1		467.640105 MHz	3.24 dBm																																																																				
D1	M1	1	5.355 kHz	2.76 dB																																																																				
Type	Ref	Trc	X-value	Y-value	Function	Function Result																																																																		
M1	1		467.63475 MHz	0.48 dBm																																																																				
T1	1		467.63475 MHz	0.48 dBm	Occ Bw	5.354558611 kHz																																																																		
T2	1		467.640105 MHz	3.24 dBm																																																																				
D1	M1	1	5.355 kHz	2.76 dB																																																																				

**4.4 FRS Modulation Limits**

Serial Number:	29CG-1	Test Date:	2023/8/20
Test Site:	RF	Test Mode:	Transmitting
Tester:	Morpheus Shi	Test Result:	Pass

**Environmental Conditions:**

Temperature: (°C)	27.7	Relative Humidity: (%)	64	ATM Pressure: (kPa)	99.9
----------------------	------	---------------------------	----	------------------------	------

**Test Equipment List and Details:**

Manufacturer	Description	Model	Serial Number	Calibration Date	Calibration Due Date
zhuoxiang	Coaxial Cable	SMA-178	211001	Each time	N/A
Mini-Circuits	DC Block	BLK-18-S+	1554403	Each time	N/A
eastsheep	Coaxial Attenuator	2W-SMA-JK-18G	21060301	Each time	N/A
Weinschel	Coaxial Attenuator	53-20-34	LN751	Each time	N/A
HP	RF Communications Test Set	8920A	3438A05209	2023/3/31	2024/3/30
R&S	Audio Analyzer	UPV	103447	2022/11/16	2023/11/15

\* Statement of Traceability: China Certification ICT Co., Ltd (Dongguan) attests that all calibrations have been performed, traceable to National Primary Standards and International System of Units (SI).

**Test Data:**

**Test Data:****MODULATION LIMITING**

Carrier Frequency: 462.6375 MHz					
Audio Frequency (Hz)	Instantaneous		Steady-state		Limit [kHz]
	Deviation (@+20dB) [kHz]	Deviation (@-20dB) [kHz]	Deviation (@+20dB) [kHz]	Deviation (@-20dB) [kHz]	
300	1.861	0.058	1.774	0.015	2.5
400	2.148	0.083	2.059	0.038	2.5
500	2.174	0.099	2.083	0.043	2.5
600	2.059	0.118	1.962	0.066	2.5
700	1.844	0.133	1.755	0.082	2.5
800	1.796	0.149	1.707	0.099	2.5
900	1.855	0.166	1.768	0.114	2.5
1000	2.001	0.182	1.916	0.125	2.5
1200	2.049	0.216	1.952	0.158	2.5
1400	1.928	0.251	1.831	0.193	2.5
1600	1.853	0.283	1.769	0.228	2.5
1800	1.834	0.318	1.743	0.264	2.5
2000	1.884	0.351	1.796	0.302	2.5
2200	1.901	0.384	1.822	0.335	2.5
2400	1.897	0.417	1.808	0.367	2.5
2600	1.909	0.449	1.811	0.396	2.5
2800	1.865	0.473	1.773	0.421	2.5
3000	1.859	0.486	1.769	0.433	2.5

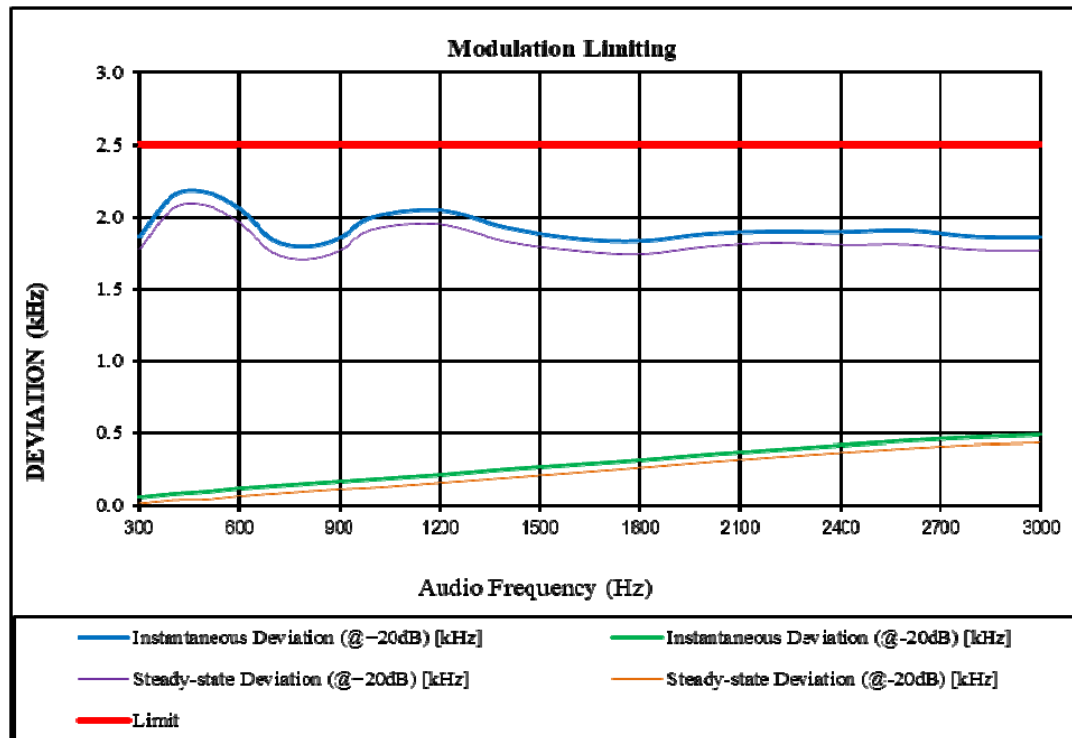

**Audio Frequency Response**  
Carrier Frequency: 462.6375 MHz

Audio Frequency (Hz)	Response Attenuation (dB)
300	-14.21
400	-8.81
500	-6.36
600	-4.63
700	-3.26
800	-2.01
900	-0.95
1000	0.00
1200	1.69
1400	3.09
1600	4.30
1800	5.36
2000	6.31
2200	7.16
2400	7.91
2600	8.53
2800	8.98
3000	9.14
3125	8.98

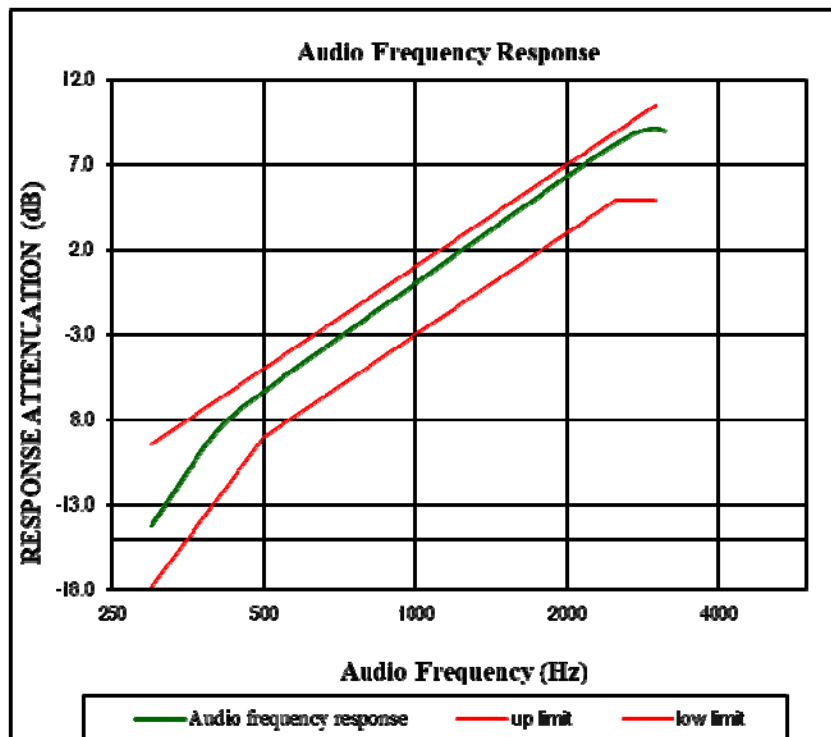

**Audio Low Pass Filter Response**

Audio Frequency	Response Attenuation	Limit
kHz	dB	dB
3.0	-5.5	0.0
3.5	-70.6	-6.7
4.0	-74.1	-12.5
5.0	-75.3	-22.2
7.0	-77.7	-36.8
10.0	-80.5	-52.3
15.0	-83.4	-69.9
20.0	-85.7	-82.5

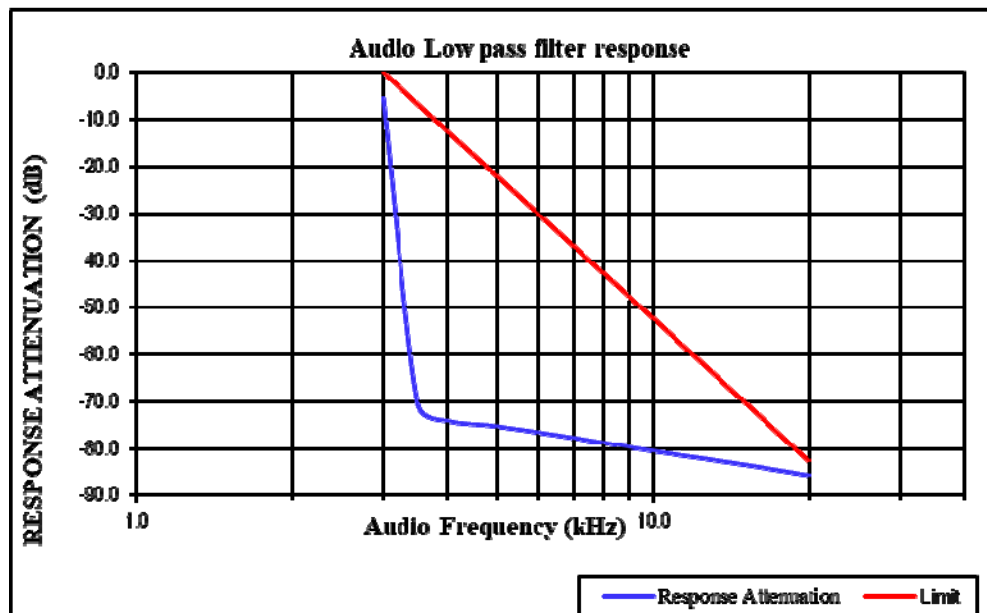

#### 4.5 Radiated Spurious Emission

Serial Number:	29CG-1	Test Date:	2023/8/19
Test Site:	966-1/966-2	Test Mode:	Transmitting
Tester:	Carl Xue, coco Tian	Test Result:	Pass

#### Environmental Conditions:

Temperature: (°C)	24.7~27.3	Relative Humidity: (%)	58~65	ATM Pressure: (kPa)	99.9
----------------------	-----------	---------------------------	-------	---------------------------	------

#### Test Equipment List and Details:

Manufacturer	Description	Model	Serial Number	Calibration Date	Calibration Due Date
Sunol Sciences	Antenna	JB6	A082520-5	2020/10/19	2023/10/18
R&S	EMI Test Receiver	ESR3	102724	2023/3/31	2024/3/30
TIMES MICROWAVE	Coaxial Cable	LMR-600-UltraFlex	C-0470-02	2023/7/16	2024/7/15
TIMES MICROWAVE	Coaxial Cable	LMR-600-UltraFlex	C-0780-01	2023/7/16	2024/7/15
EMCO	Adjustable Dipole Antenna	3121C	9109-756	N/A	N/A
MICRO-COAX	Coaxial Cable	UFA210B-0-0720-300300	99G1448	2022/7/16	2024/7/15
ETS-Lindgren	Horn Antenna	3115	9912-5985	2020/10/13	2023/10/12
R&S	Spectrum Analyzer	FSV40	101591	2023/3/31	2024/3/30
MICRO-COAX	Coaxial Cable	UFA210A-1-1200-70U300	217423-008	2023/8/6	2024/8/5
MICRO-COAX	Coaxial Cable	UFA210A-1-2362-300300	235780-001	2023/8/6	2024/8/5
Mini	Pre-amplifier	ZVA-183-S+	5969001149	2022/11/9	2023/11/8
AH	Double Ridge Guide Horn Antenna	SAS-571	1396	2021/10/18	2024/10/17
Agilent	Signal Generator	E8247C	MY43321352	2022/11/18	2023/11/17

\* **Statement of Traceability:** China Certification ICT Co., Ltd (Dongguan) attests that all calibrations have been performed, traceable to National Primary Standards and International System of Units (SI).

#### Test Data:

Please refer to the below table and plots.

After pre-scan in the X, Y and Z axes of orientation, the worst case is below:

Frequency (MHz)	Polar (H/V)	Receiver Reading (dBμV)	Substituted Method			Absolute Level (dBm)	Limit (dBm)	Margin (dB)
			Substituted Level (dBm)	Antenna Gain (dBd/dBi)	Cable Loss (dB)			
<b>frequency:462.6375 MHz</b>								
925.275	H	19.20	-48.95	0.00	0.62	-49.57	-13.00	36.57
925.275	V	19.37	-46.26	0.00	0.62	-46.88	-13.00	33.88
1387.913	H	34.26	-69.33	8.19	0.73	-61.87	-13.00	48.87
1387.913	V	34.16	-69.52	8.19	0.73	-62.06	-13.00	49.06
1850.550	H	35.27	-67.96	8.92	0.89	-59.93	-13.00	46.93
1850.550	V	35.46	-67.69	8.92	0.89	-59.66	-13.00	46.66
2313.188	H	38.64	-63.17	9.29	0.98	-54.86	-13.00	41.86
2313.188	V	35.79	-65.80	9.29	0.98	-57.49	-13.00	44.49
2775.825	H	48.76	-51.18	9.84	1.05	-42.39	-13.00	29.39
2775.825	V	45.32	-54.51	9.84	1.05	-45.72	-13.00	32.72
3238.463	H	49.64	-47.31	10.30	1.16	-38.17	-13.00	25.17
3238.463	V	46.57	-50.13	10.30	1.16	-40.99	-13.00	27.99
3701.100	H	46.59	-50.73	10.60	1.25	-41.38	-13.00	28.38
3701.100	V	47.67	-49.62	10.60	1.25	-40.27	-13.00	27.27
4163.738	H	48.60	-47.37	10.80	1.30	-37.87	-13.00	24.87
4163.738	V	41.02	-54.92	10.80	1.30	-45.42	-13.00	32.42
4626.375	H	34.95	-60.33	10.75	1.41	-50.99	-13.00	37.99
4626.375	V	35.76	-59.41	10.75	1.41	-50.07	-13.00	37.07
<b>frequency:467.6375MHz</b>								
935.275	H	19.11	-48.80	0.00	0.66	-49.46	-13.00	36.46
935.275	V	19.68	-45.76	0.00	0.66	-46.42	-13.00	33.42
1402.913	H	34.63	-69.07	8.23	0.71	-61.55	-13.00	48.55
1402.913	V	34.75	-68.99	8.23	0.71	-61.47	-13.00	48.47
1870.550	H	36.59	-66.54	8.94	0.89	-58.49	-13.00	45.49
1870.550	V	34.99	-67.95	8.94	0.89	-59.90	-13.00	46.90
2338.188	H	48.64	-52.95	9.30	0.97	-44.62	-13.00	31.62
2338.188	V	44.61	-56.75	9.30	0.97	-48.42	-13.00	35.42
2805.825	H	48.35	-51.55	9.89	1.04	-42.70	-13.00	29.70
2805.825	V	46.35	-53.44	9.89	1.04	-44.59	-13.00	31.59
3273.463	H	50.34	-46.45	10.31	1.16	-37.30	-13.00	24.30
3273.463	V	44.86	-51.69	10.31	1.16	-42.54	-13.00	29.54
3741.100	H	48.35	-48.35	10.64	1.23	-38.94	-13.00	25.94
3741.100	V	49.60	-47.01	10.64	1.23	-37.60	-13.00	24.60
4208.738	H	50.64	-45.33	10.77	1.33	-35.89	-13.00	22.89
4208.738	V	50.64	-45.29	10.77	1.33	-35.85	-13.00	22.85
4676.375	H	34.29	-60.68	10.81	1.41	-51.28	-13.00	38.28
4676.375	V	34.78	-60.17	10.81	1.41	-50.77	-13.00	37.77

Note 1: The unit of antenna gain is dBd for frequency below 1GHz and is dBi for frequency above 1GHz.

Note 2:

Absolute Level = Substituted Level - Cable loss + Antenna Gain

Margin = Limit- Absolute Level

## **5. EUT PHOTOGRAPHS**

---

Please refer to the attachment CR230846428-EXP EUT EXTERNAL PHOTOGRAPHS and CR230846428-INP EUT INTERNAL PHOTOGRAPHS.



## **6. TEST SETUP PHOTOGRAPHS**

---

Please refer to the Attachment: CR230846428-00-TSP.

**===== END OF REPORT =====**