



TEST REPORT

Report No.....: **CHTEW22040172** Report Verification: 

Project No.....: **SHT2203063401EW**

FCC ID.....: **2A3OORM40**

Applicant's name.....: **Shenzhen Ysair Technology Co., LTD**

Address.....: 6/F, building 6, Yunli intelligent park, No. 3, Changfa Middle Road, Yangmei community, Bantian street, Longgang District, Shenzhen, Guangdong, China

Test item description: **Two Way Radio**

Trade Mark: RETEVIS

Model/Type reference.....: RM40

Listed Model(s): -

Standard: **FCC CFR Title 47 Part 15 Subpart B**

Date of receipt of test sample.....: Mar.29, 2022

Date of testing.....: Mar.30, 2022-Apr.22, 2022

Date of issue.....: Apr.24, 2022

Result.....: **PASS**

Compiled by
 (position+printed name+signature)...: File administrators Fanghui Zhu

Supervised by
 (position+printed name+signature)...: Project Engineer Cheng Xiao

Approved by
 (Position-Printed name-Signature) : RF Manager Hans Hu

Fanghui Zhu

Cheng Xiao

Hans Hu

Testing Laboratory Name: **Shenzhen Huatongwei International Inspection Co., Ltd.**

Address.....: 1/F, Bldg 3, Hongfa Hi-tech Industrial Park, Genyu Road, Tianliao, Gongming, Shenzhen, China

Shenzhen Huatongwei International Inspection Co., Ltd. All rights reserved.

This publication may be reproduced in whole or in part for non-commercial purposes as long as the Shenzhen Huatongwei International Inspection Co., Ltd. is acknowledged as copyright owner and source of the material. Shenzhen Huatongwei International Inspection Co., Ltd. takes no responsibility for and will not assume liability for damages resulting from the reader's interpretation of the reproduced material due to its placement and context.

The test report merely corresponds to the test sample.

Contents

1.	<u>TEST STANDARDS AND REPORT VERSION</u>	<u>3</u>
1.1.	Test Standards	3
1.2.	Report version	3
2.	<u>TEST DESCRIPTION</u>	<u>4</u>
3.	<u>SUMMARY.....</u>	<u>5</u>
3.1.	Client information	5
3.2.	Product description	5
3.3.	Radio Specification Description	6
3.4.	Testing Laboratory Information	6
4.	<u>TEST CONFIGURATION.....</u>	<u>7</u>
4.1.	Operation mode	7
4.2.	Support unit used in test configuration and system	7
4.3.	Testing environmental condition	7
4.4.	Statement of the measurement uncertainty	7
4.5.	Equipments Used during the Test	8
5.	<u>TEST CONDITIONS AND RESULTS</u>	<u>9</u>
5.1.	Conducted Emissions	9
5.2.	Radiated Emissions	12
5.3.	Antenna conducted power for reciver	16
5.4.	Sanning receivers and frequency converters used with sanning receviars	18
6.	<u>TEST SETUP PHOTOS OF THE EUT</u>	<u>19</u>
7.	<u>EXTERNAL AND INTERNAL PHOTOS OF THE EUT</u>	<u>20</u>

1. TEST STANDARDS AND REPORT VERSION

1.1. Test Standards

The tests were performed according to following standards:

[FCC CFR Title 47 Part 15 Subpart B](#) - Unintentional Radiators

[ANSI C63.4: 2014](#) – American National Standard for Methods of Measurement of Radio-Noise Emissions from Low-Voltage Electrical and Electronic Equipment in the Range of 9 kHz to 40GHz

1.2. Report version

Revision No.	Date of issue	Description
N/A	2022-04-24	Original

2. TEST DESCRIPTION

Section	Test Item	Section in CFR 47	Result	Test Engineer
5.1	Conducted Emissions	15.107(a)	Pass	Quanhai Deng
5.2	Radiated Emissions	15.109(a)	Pass	Hongtao Meng
5.3	Antenna conducted power for receiver	15.111	Pass	Caspar Chen
5.4	Scanning receivers and frequency converters used with scanning receivers	15.121(b)	N/A #1	Caspar Chen

Note:

1. The measurement uncertainty is not included in the test result.
2. #1, The scanning receive frequency range of this EUT is from 156.025~162.025MHz, 161.6500MHz to 163.275MHz, not in the cellular radiotelephone service frequency bands, so this item is not applicable.

3. SUMMARY

3.1. Client information

Applicant:	Shenzhen Ysair Technology Co., LTD
Address:	6/F, building 6, Yunli intelligent park, No. 3, Changfa Middle Road, Yangmei community, Bantian street, Longgang District, Shenzhen,Guangdong,China
Manufacturer:	Shenzhen Ysair Technology Co., LTD
Address:	6/F, building 6, Yunli intelligent park, No. 3, Changfa Middle Road, Yangmei community, Bantian street, Longgang District, Shenzhen,Guangdong,China

3.2. Product description

Main unit	
Name of EUT:	Two Way Radio
Trade Mark:	RETEVIS
Model/Type reference:	RM40
Listed Model(s)	-
Power supply:	DC7.4V from battery
Hardware version:	6PM7-5788-HMB
Software version:	V1.012
Ancillary unit	
Battery information:	Model: BL40 Voltage: DC7.4V Capacity: 1500mAh(11.1Wh)
Adapter information:	Model: CG-D120050 Input: 100-240Va.c., 50/60Hz 0.6A Max Output: 12Vd.c., 500mA
Cradle charger:	Model: DC40 Input: DC12V \pm 2V;450mA Output: DC8.4V;350mA
Car charger:	Model: DC40 Input: DC12V-16V

3.3. Radio Specification Description

Support Frequency Range:	156.025~162.025MHz		
Weather channel and frequency	Weather Channel	Frequency (MHz)	
		Transmit	Receive
	1	RX Only	162.550
	2	RX Only	162.400
	3	RX Only	162.475
	4	RX Only	162.425
	5	RX Only	162.450
	6	RX Only	162.500
	7	RX Only	162.525
	8	RX Only	161.650
	9	RX Only	161.775
10	RX Only	163.275	
Modulation Type:	FM		
Antenna Type:	detachable		
GNSS type:	<input checked="" type="checkbox"/> GPS		
Operation frequency:	1575.42MHz		
Modulation Type:	GPS		
Antenna Type:	Internal antenna		

3.4. Testing Laboratory Information

Laboratory Name	Shenzhen Huatongwei International Inspection Co., Ltd.	
Laboratory Location	1/F, Bldg 3, Hongfa Hi-tech Industrial Park, Genyu Road, Tianliao, Gongming, Shenzhen, China	
Connect information:	Tel: 86-755-26715499	
	E-mail: cs@szhtw.com.cn	
	http://www.szhtw.com.cn	
Qualifications	Type	Accreditation Number
	FCC Test Firm Registration Number	762235

4. TEST CONFIGURATION

4.1. Operation mode

Test mode	Describe
Charging mode	Keep the EUT in charging mode, but the EUT shut down.
Scan receive mode	Scanning stopped, receiving signal at 162.025MHz

Receive frequency: 162.025MHz

Section	Test item	Test mode
5.1	Conducted emissions	Charging mode
5.2	Radiated emissions	Charging mode, scan receive mode
5.3	Antenna conducted power for receiver	scan receive mode
5.4	Scanning receivers and frequency converters used with scanning receivers	scan receive mode

Only show the test data for worst case mode on the test report.

4.2. Support unit used in test configuration and system

The EUT has been associated with peripherals and configuration operated in a manner tended to maximize its emission characteristics in a typical application.

The following peripheral devices and interface cables were connected during the measurement:

Whether support unit is used?			
✓ No			
Item	Equipment	Trade Name	Model No.
1			
2			

4.3. Testing environmental condition

Type	Requirement	Actual
Temperature:	15~35°C	25°C
Relative Humidity:	25~75%	50%
Air Pressure:	860~1060mbar	1000mbar

4.4. Statement of the measurement uncertainty

Test	Frequency range	Measurement uncertainty
Radiated Emission	30~1000MHz	4.90 dB
Radiated Emission	1~18GHz	4.96 dB
Conducted Disturbance	0.15~30MHz	3.02 dB

This uncertainty represents an expanded uncertainty expressed at approximately the 95% confidence level using a coverage factor of k=1.96.

4.5. Equipments Used during the Test

● Conducted Emission							
Used	Test Equipment	Manufacturer	Equipment No.	Model No.	Serial No.	Last Cal. Date (YY-MM-DD)	Next Cal. Date (YY-MM-DD)
●	Shielded Room	Albatross projects	HTWE0114	N/A	N/A	2018/09/28	2023/09/27
●	EMI Test Receiver	R&S	HTWE0111	ESCI	101247	2021/09/14	2022/09/13
●	Artificial Mains	SCHWARZBECK	HTWE0113	NNLK 8121	573	2021/09/17	2022/09/16
●	Pulse Limiter	R&S	HTWE0193	ESH3-Z2	101447	2021/09/16	2022/09/15
●	RF Connection Cable	HUBER+SUHNER	HTWE0113-02	ENVIROFLEX_142	EF-NM-BNCM-2M	2021/09/17	2022/09/16
●	Test Software	R&S	N/A	ES-K1	N/A	N/A	N/A

● Radiated Emission-6th test site							
Used	Test Equipment	Manufacturer	Equipment No.	Model No.	Serial No.	Last Cal. Date (YY-MM-DD)	Next Cal. Date (YY-MM-DD)
●	Semi-Anechoic Chamber	Albatross projects	HTWE0127	SAC-3m-02	C11121	2018/09/30	2022/09/29
●	EMI Test Receiver	R&S	HTWE0099	ESCI	100900	2021/09/14	2022/09/13
●	Ultra-Broadband Antenna	SCHWARZBECK	HTWE0119	VULB9163	546	2020/04/28	2023/04/27
●	Pre-Amplifier	SCHWARZBECK	HTWE0295	BBV 9742	N/A	2021/11/05	2022/11/04
●	RF Connection Cable	HUBER+SUHNER	HTWE0062-01	N/A	N/A	2022/02/25	2023/02/24
●	RF Connection Cable	HUBER+SUHNER	HTWE0062-02	SUCOFLEX104	501184/4	2022/02/25	2023/02/24
●	Test Software	R&S	N/A	ES-K1	N/A	N/A	N/A

● Radiated emission-7th test site							
Used	Test Equipment	Manufacturer	Equipment No.	Model No.	Serial No.	Last Cal. Date (YY-MM-DD)	Next Cal. Date (YY-MM-DD)
●	Semi-Anechoic Chamber	Albatross projects	HTWE0122	SAC-3m-01	C11121	2018/09/27	2022/09/26
●	Spectrum Analyzer	R&S	HTWE0098	FSP40	100597	2021/09/13	2022/09/12
●	Horn Antenna	SCHWARZBECK	HTWE0126	9120D	1011	2020/04/01	2023/03/31
●	Broadband Pre-amplifier	SCHWARZBECK	HTWE0201	BBV 9718	9718-248	2022/02/28	2023/02/27
●	RF Connection Cable	HUBER+SUHNER	HTWE0126-01	RE-7-FH	N/A	2022/03/04	2023/03/03
●	Test Software	Audix	N/A	E3	N/A	N/A	N/A

5. TEST CONDITIONS AND RESULTS

5.1. Conducted Emissions

LIMIT

FCC CFR Title 47 Part 15 Subpart B Section 15.107:

Frequency range (MHz)	Limit (dBuV)	
	Quasi-peak	Average
0.15-0.5	66 to 56*	56 to 46*
0.5-5	56	46
5-30	60	50

* Decreases with the logarithm of the frequency.

TEST CONFIGURATION

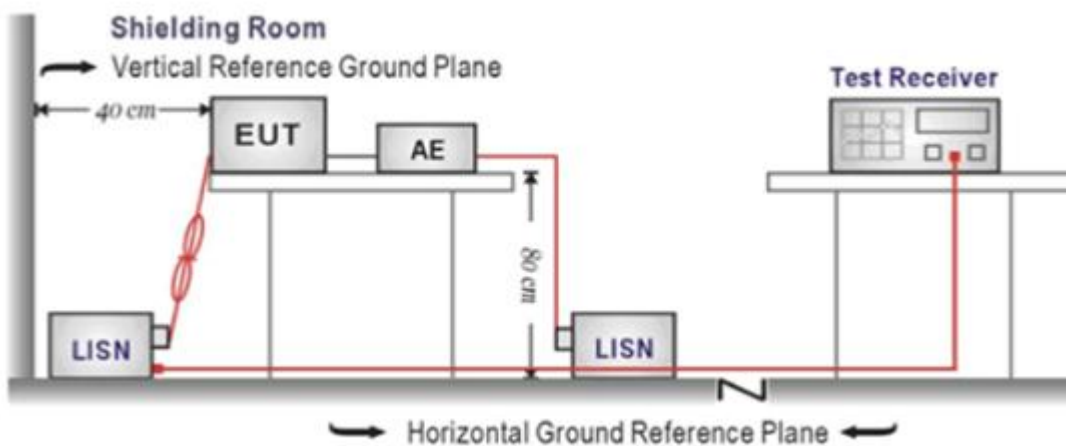

TEST PROCEDURE

1. The EUT was setup according to ANSI C63.4
2. The EUT was placed on a plat form of nominal size, 1 m by 1.5 m, raised 10 cm above the conducting ground plane. The vertical conducting plane was located 40 cm to the rear of the EUT. All other surfaces of EUT were at least 10 cm from any other grounded conducting surface.
3. The EUT and simulators are connected to the main power through a line impedance stabilization network (LISN). The LISN provides a 50ohm / 50uH coupling impedance for the measuring equipment.
4. The peripheral devices are also connected to the main power through a LISN. (Please refer to the block diagram of the test setup and photographs)
5. Each current-carrying conductor of the EUT power cord, except the ground (safety) conductor, was individually connected through a LISN to the input power source.
6. The excess length of the power cord between the EUT and the LISN receptacle were folded back and forth at the center of the lead to form a bundle not exceeding 40 cm in length.
7. Conducted emissions were investigated over the frequency range from 0.15MHz to 30MHz using a receiver bandwidth of 9 kHz.
8. During the above scans, the emissions were maximized by cable manipulation.

TEST MODE:

Please refer to the clause 4.1

TEST RESULTS

Passed Not Applicable

Test Line:

L

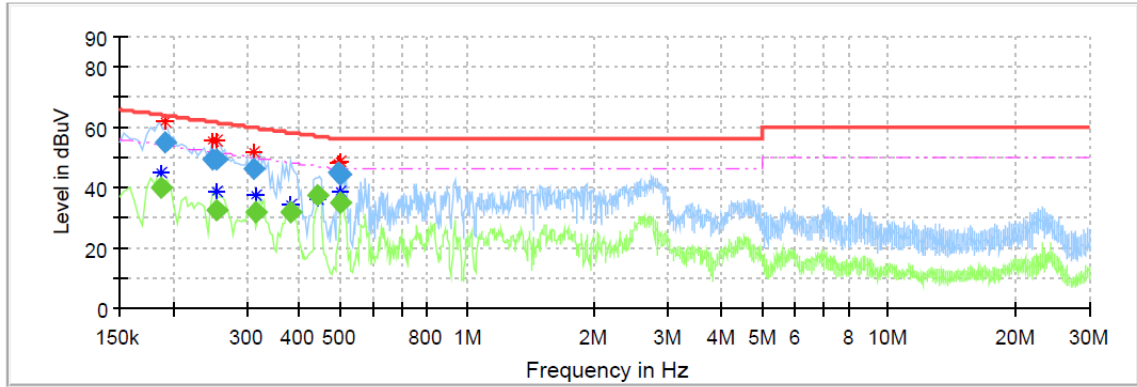

Frequency (MHz)	QuasiPeak (dBuV)	CAverage (dBuV)	Limit (dBuV)	Margin (dB)	Line	Corr. (dB)
0.187500	---	40.11	54.15	14.04	L1	10.1
0.191500	54.86	---	63.97	9.11	L1	10.1
0.247500	49.45	---	61.84	12.39	L1	10.1
0.255500	---	32.63	51.58	18.94	L1	10.1
0.255500	49.16	---	61.58	12.41	L1	10.1
0.311500	45.95	---	59.93	13.98	L1	10.1
0.315500	---	31.91	49.82	17.92	L1	10.1
0.379500	---	31.66	48.29	16.63	L1	10.1
0.439500	---	37.60	47.07	9.47	L1	10.1
0.495500	44.91	---	56.08	11.16	L1	10.1
0.499500	---	34.95	46.01	11.06	L1	10.1
0.499500	44.34	---	56.01	11.67	L1	10.1

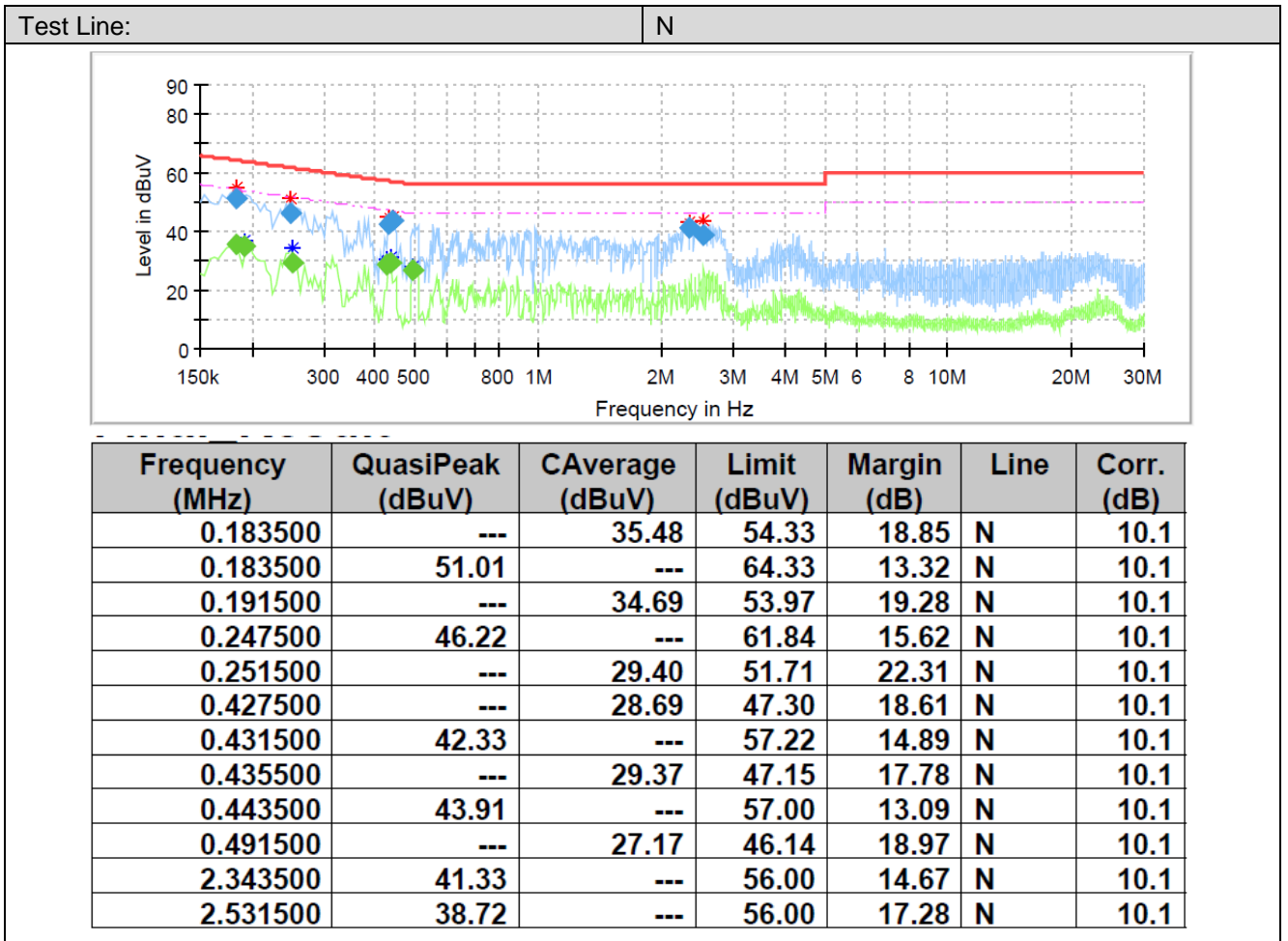

5.2. Radiated Emissions

LIMIT

FCC CFR Title 47 Part 15 Subpart B Section 15.109

Frequency	Limit (dBuV/m @3m)	Value
30MHz-88MHz	40.00	Quasi-peak
88MHz-216MHz	43.50	Quasi-peak
216MHz-960MHz	46.00	Quasi-peak
960MHz-1GHz	54.00	Quasi-peak
Above 1GHz	54.00	Average
	74.00	Peak

TEST CONFIGURATION

➤ 30MHz ~ 1GHz

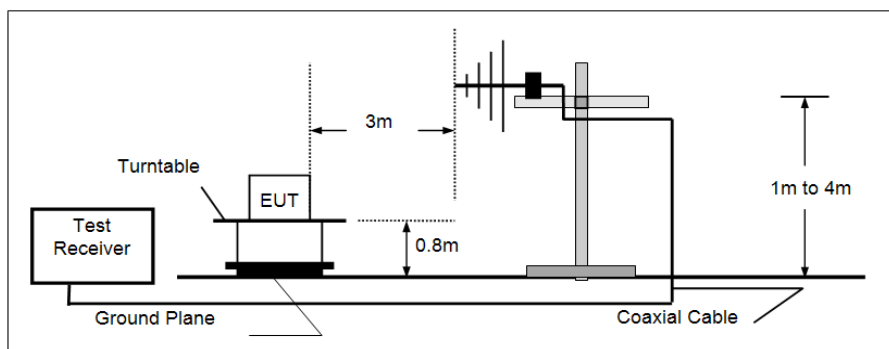

➤ Above 1GHz

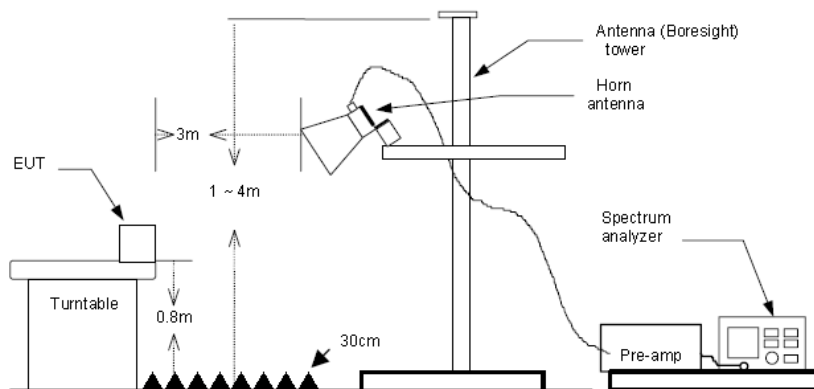

TEST PROCEDURE

- The EUT was tested according to ANSI C63.4.
- The EUT is placed on a turn table which is 0.8 meter above ground.
- The turn table is rotated 360 degrees to determine the position of the maximum emission level.
- The EUT was positioned such that the distance from antenna to the EUT was 3 meters.
- The antenna is scanned from 1 meter to 4 meters to find out the maximum emission level. This is repeated for both horizontal and vertical polarization of the antenna.
- Use the following spectrum analyzer settings
 - Span shall wide enough to fully capture the emission being measured;
 - Below 1GHz,
 - RBW=120KHz, VBW=300KHz, Sweep=auto, Detector function=peak, Trace=max hold;
 - If the emission level of the EUT measured by the peak detector is 3 dB lower than the applicable limit, the peak emission level will be reported. Otherwise, the emission measurement will be repeated using the quasi-peak detector and reported.
 - From 1GHz to 5th harmonic, RBW=1MHz, VBW=3MHz

TEST MODE:

Please refer to the clause 4.1

TEST RESULTS

Passed **Not Applicable**

Note: Final Level = Receiver Read level + Antenna Factor + Cable Loss – Pre-amplifier Factor
The emission levels of frequency above 6GHz are very lower than limit and not show in test report.

Test mode	Charging mode	Polarization:	Horizontal
-----------	---------------	---------------	------------

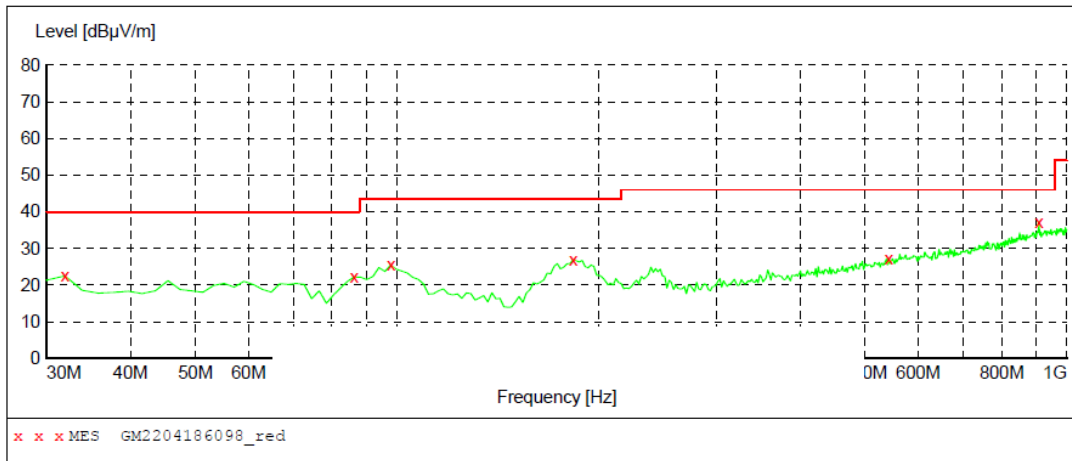

MEASUREMENT RESULT: "GM2204186098_red"

4/18/2022 7:51PM

Frequency MHz	Level dBuV/m	Transd dB	Limit dBuV/m	Margin dB	Det.	Height cm	Azimuth deg	Polarization
31.940000	22.50	-12.1	40.0	17.5	QP	300.0	33.00	HORIZONTAL
86.260000	22.20	-13.7	40.0	17.8	QP	300.0	152.00	HORIZONTAL
97.900000	25.50	-11.2	43.5	18.0	QP	300.0	141.00	HORIZONTAL
183.260000	26.80	-12.0	43.5	16.7	QP	300.0	360.00	HORIZONTAL
542.160000	27.30	-0.3	46.0	18.7	QP	300.0	22.00	HORIZONTAL
908.820000	37.30	7.0	46.0	8.7	QP	100.0	35.00	HORIZONTAL

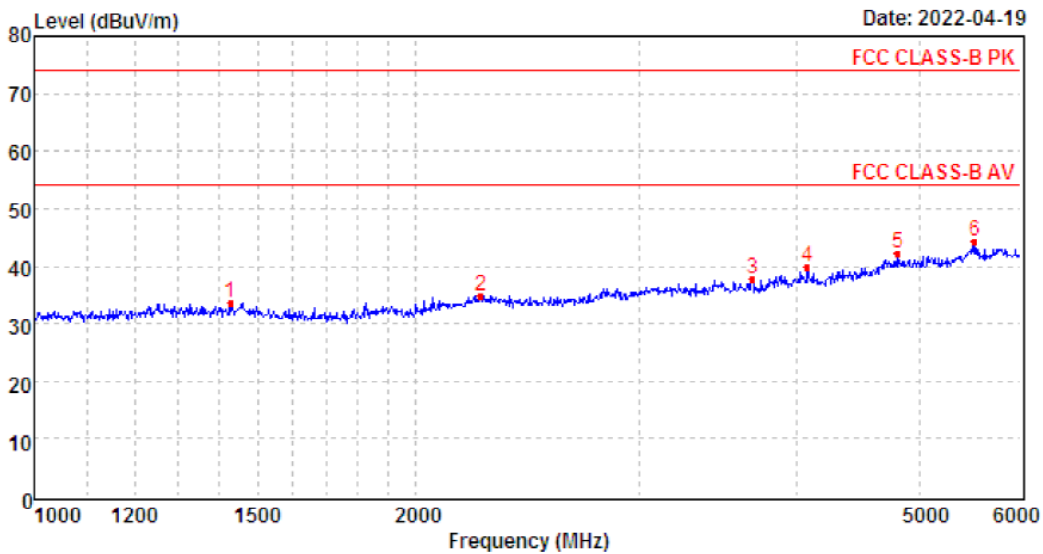

Mark	Frequency MHz	Reading dBuV/m	Antenna dB	Cable dB	Preamp dB	Level dBuV/m	Limit dBuV/m	Over limit	Remark
1	1428.41	40.00	26.10	4.21	36.63	33.68	74.00	-40.32	Peak
2	2251.66	38.89	28.10	5.37	37.43	34.93	74.00	-39.07	Peak
3	3685.48	38.49	29.40	7.00	37.14	37.75	74.00	-36.25	Peak
4	4074.47	38.62	30.00	7.45	36.33	39.74	74.00	-34.26	Peak
5	4804.64	36.42	31.40	8.46	34.12	42.16	74.00	-31.84	Peak
6	5525.31	35.64	31.85	9.36	32.49	44.36	74.00	-29.64	Peak

Test mode	Charging mode	Polarization:	Vertical
-----------	---------------	---------------	----------

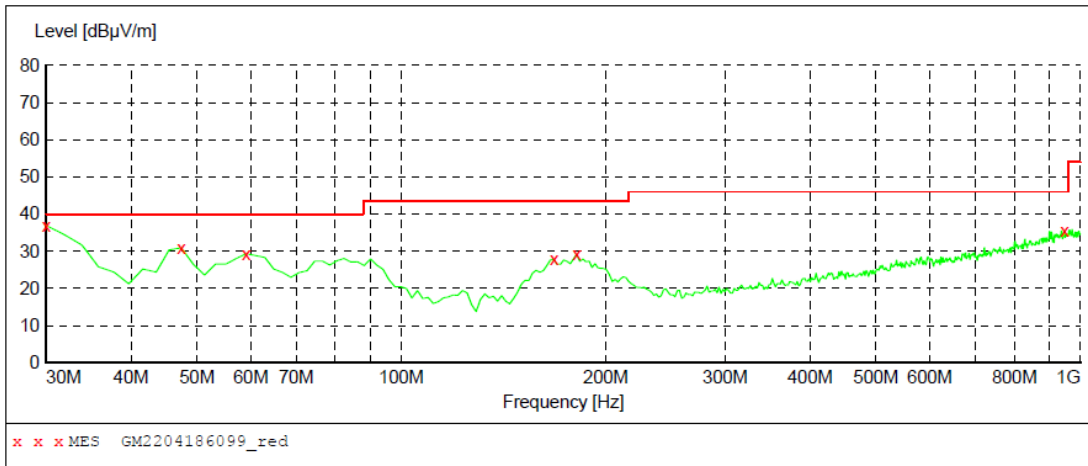

MEASUREMENT RESULT: "GM2204186099_red"

4/18/2022 7:55PM

Frequency MHz	Level dBuV/m	Transd dB	Limit dBuV/m	Margin dB	Det.	Height cm	Azimuth deg	Polarization
30.000000	36.90	-12.7	40.0	3.1	QP	100.0	129.00	VERTICAL
47.460000	30.90	-9.2	40.0	9.1	QP	100.0	92.00	VERTICAL
59.100000	29.30	-9.9	40.0	10.7	QP	100.0	355.00	VERTICAL
167.740000	27.80	-13.2	43.5	15.7	QP	100.0	224.00	VERTICAL
181.320000	29.10	-12.2	43.5	14.4	QP	100.0	81.00	VERTICAL
947.620000	35.60	7.6	46.0	10.4	QP	100.0	224.00	VERTICAL

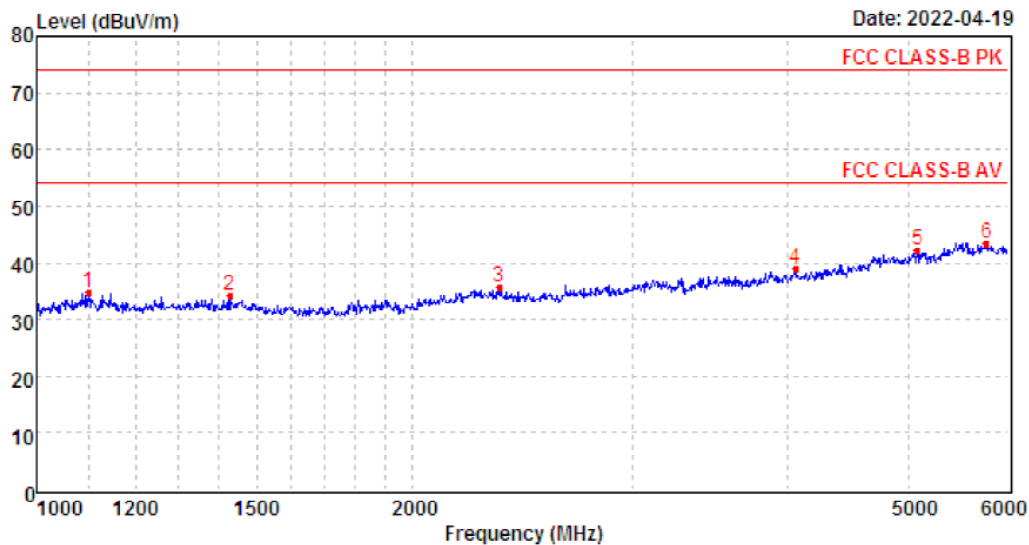

Mark	Frequency MHz	Reading dBuV/m	Antenna dB	Cable dB	Preamp dB	Level dBuV/m	Limit dBuV/m	Over limit	Remark
1	1099.62	42.71	25.40	3.70	37.05	34.76	74.00	-39.24	Peak
2	1428.41	40.41	26.10	4.21	36.63	34.09	74.00	-39.91	Peak
3	2346.39	39.82	27.81	5.47	37.32	35.78	74.00	-38.22	Peak
4	4052.62	37.87	30.00	7.43	36.44	38.86	74.00	-35.14	Peak
5	5079.06	35.97	32.20	8.91	34.85	42.23	74.00	-31.77	Peak
6	5768.09	35.41	31.94	9.58	33.39	43.54	74.00	-30.46	Peak

5.3. Antenna conducted power for receiver

LIMIT

FCC CFR Title 47 Part 15 Subpart B Section 15.111:

Frequency range	Limit
9KHz to 3GHz	2.0 nW (-57dBm)

TEST CONFIGURATION

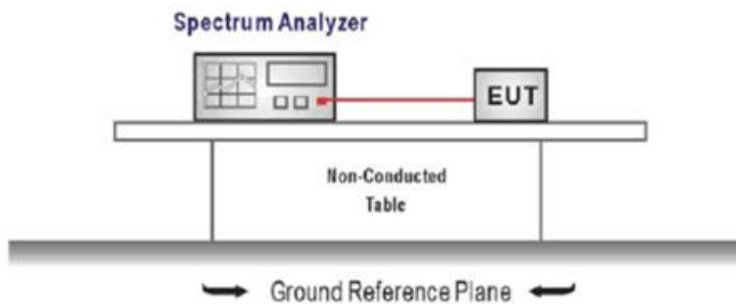

TEST PROCEDURE

1. The receiver antenna terminal connected to a spectrum analyzer.
2. Receiver set as follow:

Frequency range	RBW (kHz)	VBW (kHz)
9 kHz ~ 150 kHz	1	3
150 kHz ~ 30 MHz	10	30
30 MHz ~ 1000 MHz	100	300
1000 MHz ~ 3000 MHz	1000	3000

TEST MODE:

Please refer to the clause 4.1

TEST RESULTS

Passed Not Applicable

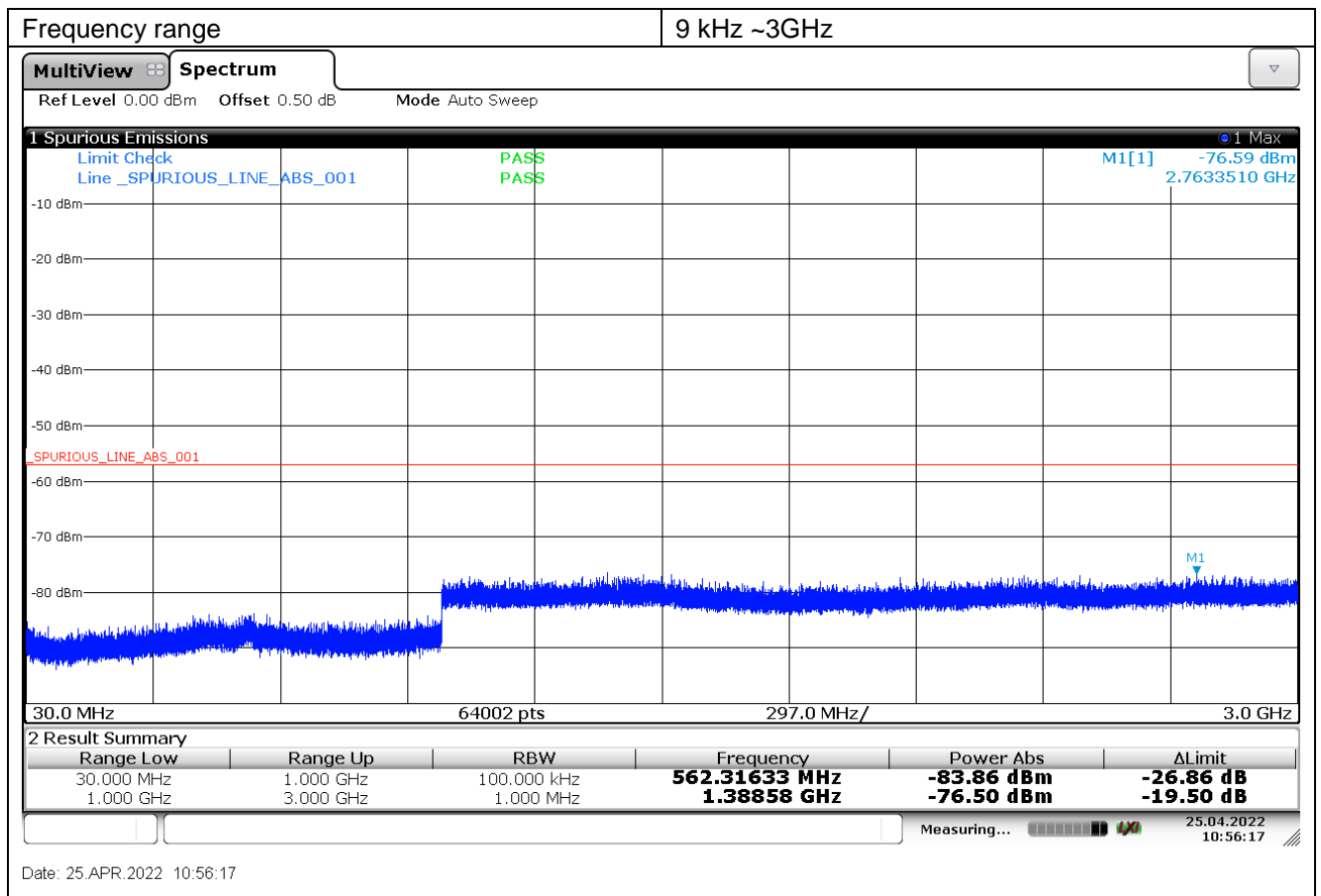

5.4. Scanning receivers and frequency converters used with scanning receivers

LIMIT

scanning receivers shall reject any signals from the Cellular Radiotelephone Service frequency bands that are 38 dB or lower based upon a 12 dB SINAD measurement, which is considered the threshold where a signal can be clearly discerned from any interference that may be present

TEST CONFIGURATION

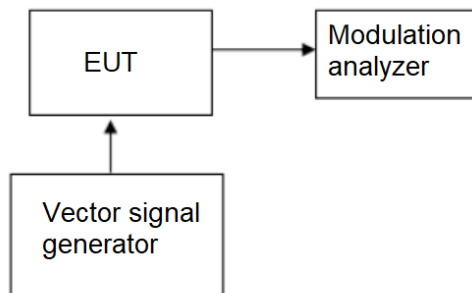

TEST PROCEDURE

The RF level of vector signal generator will be adjusted to produce GSM signals at the receiver antenna port of the EUT.

TEST MODE:

Please refer to clause 4.1

TEST RESULTS

Passed Not Applicable

The scanning receive frequency range of this EUT is from 156.025~162.025MHz, 161.6500MHz to 163.275MHz, not in the cellular radiotelephone service frequency bands, so this item is not applicable.

6. TEST SETUP PHOTOS OF THE EUT

Conducted Emissions (AC Mains)



Radiated Emissions

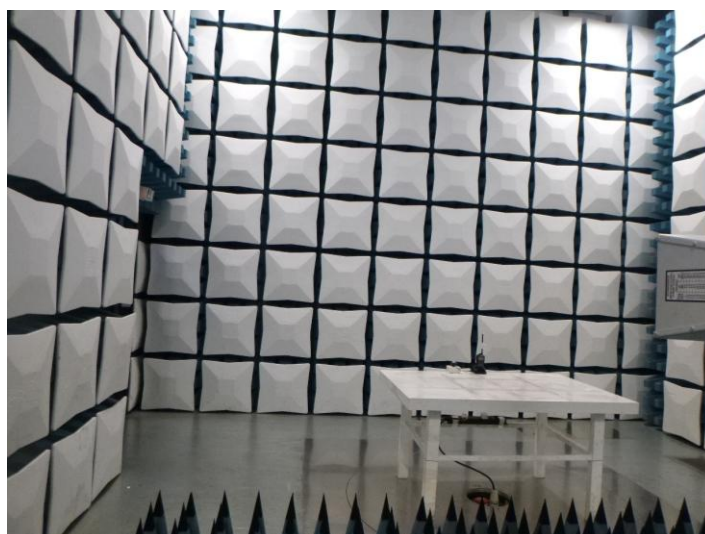

7. EXTERNAL AND INTERNAL PHOTOS OF THE EUT

Refer to the test report No.: CHTEW22040171

-----End of Report-----