



TEST REPORT

For EMC

Report Reference No...... : **CHTEW22060052** Report verification : 

Project No. : **SHT2204047901EW**

FCC ID..... : **2A3OORM20**

Applicant's name : **Shenzhen Ysair Technology Co., LTD**

Address..... : 6/F, building 6, Yunli intelligent park, No. 3, Changfa Middle Road, Yangmei community, Bantian street, Longgang District, Shenzhen, Guangdong, China

Test item description : **VHF Marine Radio**

Trade Mark : RETEVIS

Model/Type reference..... : RM20

Listed Model(s) : -

Standard : **IEC60945:2002**

Date of receipt of test sample..... : Apr.27, 2022

Date of testing..... : Apr.28, 2022-Jun.06, 2022

Date of issue..... : Jun.07, 2022

Result..... : **PASS**

Compiled by
 (position+printed name+signature)... : File administrators Fanghui Zhu 

Supervised by
 (position+printed name+signature)... : Project Engineer Cheng Xiao 

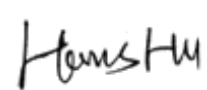
Approved by
 (position+printedname+signature).... : RF Manager Hans Hu 

Testing Laboratory Name : **Shenzhen Huatongwei International Inspection Co., Ltd.**

Address..... : 1/F, Bldg 3, Hongfa Hi-tech Industrial Park, Genyu Road, Tianliao, Gongming, Shenzhen, China

Shenzhen Huatongwei International Inspection Co., Ltd. All rights reserved.

This publication may be reproduced in whole or in part for non-commercial purposes as long as the Shenzhen Huatongwei International Inspection Co., Ltd. is acknowledged as copyright owner and source of the material. Shenzhen Huatongwei International Inspection Co., Ltd. takes no responsibility for and will not assume liability for damages resulting from the reader's interpretation of the reproduced material due to its placement and context.

The test report merely corresponds to the test sample.

Contents

1.	<u>TEST STANDARDS AND REPORT VERSION</u>	<u>3</u>
1.1.	Test Standards	3
1.2.	Report version	3
2.	<u>TEST DESCRIPTION</u>	<u>4</u>
3.	<u>SUMMARY</u>	<u>5</u>
3.1.	Client Information	5
3.2.	Product Description	5
3.3.	EUT operation mode	6
3.4.	EUT configuration	6
4.	<u>TEST ENVIRONMENT.....</u>	<u>7</u>
4.1.	Address of the test laboratory	7
4.2.	Environmental conditions	8
4.3.	Statement of the measurement uncertainty	8
4.4.	Equipments Used during the Test	9
5.	<u>TEST CONDITIONS AND RESULTS</u>	<u>12</u>
5.1.	EMISSION	12
5.1.1.	Conducted Emissions	12
5.1.2.	Radiated Emission	14
5.2.	IMMUNITY	18
5.2.1.	Conducted radio frequency disturbance	19
5.2.2.	Radiated radio frequencies	20
5.2.3.	Power supply transients	21
5.2.4.	Power supply variations and failure	22
5.2.5.	Electrostatic Discharge	23
5.3.	Environmental Test	26
5.3.1.	Dry heat	26
5.3.2.	Damp heat	26
5.3.3.	Low temperature	27
5.3.4.	Vibration	27
6.	<u>TEST SETUP PHOTOS.....</u>	<u>28</u>
7.	<u>EXTERNAL AND INTERNAL PHOTOS OF THE EUT.....</u>	<u>30</u>

1. Test standards and Report version

1.1. Test Standards

The tests were performed according to following standards:

[IEC60945:2002](#)–Maritime navigation and radiocommunication equipment and systems -General requirements
-Methods of testing and required test result

1.2. Report version

Version No.	Date of issue	Description
N/A	2022-06-07	Original

2. Test Description

Emission			
Test item	Standards requirement (ETSI EN 300 698)	Result	Test Engineer
Conducted emissions	Sub-clause 9.2	Pass	Jian Li
Radiated emissions	Sub-clause 9.3	Pass	Quanhai Deng
Immunity			
Test item	Standards requirement (ETSI EN 300 698)	Result	Test Engineer
Conducted radio frequency disturbance	Sub-clause 10.3	Pass	Quanhai Deng
Radiated disturbance	Sub-clause 10.4	Pass	Quanhai Deng
Power supply transients	Sub-clause 10.7	NA	-
Power supply variations and failure	Sub-clause 10.8	NA	-
Electrostatic discharge	Sub-clause 10.9	Pass	Quanhai Deng
Environmental Test			
Test item	Standards requirement (ETSI EN 300 698)	Result	Test Engineer
Dry heat	Sub-clause 8.2	Pass	Quanhai Deng
Damp heat	Sub-clause 8.3	Pass	Quanhai Deng
Low temperature	Sub-clause 8.4	Pass	Quanhai Deng
Vibration	Sub-clause 8.7	Pass	Quanhai Deng

Note: The measurement uncertainty is not included in the test result.

3. Summary

3.1. Client Information

Applicant:	Shenzhen Ysair Technology Co., LTD
Address:	6/F, building 6, Yunli intelligent park, No. 3, Changfa Middle Road, Yangmei community, Bantian street, Longgang District, Shenzhen,Guangdong,China
Manufacturer:	Shenzhen Ysair Technology Co., LTD
Address:	6/F, building 6, Yunli intelligent park, No. 3, Changfa Middle Road, Yangmei community, Bantian street, Longgang District, Shenzhen,Guangdong,China

3.2. Product Description

Main unit	
Name of EUT:	VHF Marine Radio
Trade Mark:	RETEVIS
Model/Type reference:	RM20
Listed Model(s)	-
Power supply:	DC13.8V
Hardware version:	M-200BM-J150618
Software version:	V6PD7-2008-BME
RF Specification	
Support Frequency Range:	156.025~162.025MHz
Permitted frequency range:	TX:156.025MHz to 157.425MHz RX:156.050MHz to 162.025MHz
Rated Output Power:	<input checked="" type="checkbox"/> High Power: 25W <input checked="" type="checkbox"/> Low Power: 1W
Modulation Type:	Analog: FM
	Digital Data(DSC): AFSK
Channel Separation:	Analog: <input checked="" type="checkbox"/> 25kHz
	Digital Data(DSC): <input checked="" type="checkbox"/> 25kHz
Emission Designator: *1	Analog: 16K0F3E
	Digital Data(DSC): 16K0G2B
Antenna Type:	detachable

Note:

(1) *1 According to FCC Part 2.202 requirements, the Necessary Bandwidth is calculated as follows:

- For FM Voice Modulation

Channel Spacing = 25 KHz, D = 5KHz max, K = 1, M = 3KHz

$B_n = 2M + 2DK = 2*3 + 2*5*1 = 16 \text{ KHz}$

Emission designation: 16K0F3E

- Digital Data(DSC)

Channel Spacing = 25 KHz, D = 5KHz max, K = 1, M = 3KHz

$B_n = 2M + 2DK = 2*3 + 2*5*1 = 16 \text{ KHz}$

Emission designation: 16K0G2B

3.3. EUT operation mode

Test mode	Transmitting	Receiving	Power level		Analog Voice/PM
			High	Low	25kHz
TX-AWH	√		√		√
TX-AWL	√			√	√
RX-AW		√			√

Only show the test data for worse case mode on the test report.

3.4. EUT configuration

The following peripheral devices and interface cables were connected during the measurement:

- - supplied by the manufacturer
- - supplied by the lab

●	DC Power Cable	Length (m) :	/
		Shield :	/
		Detachable :	/
○	Multimeter	Manufacturer :	/
		Model No. :	/

4. Test Environment

4.1. Address of the test laboratory

Laboratory Name	Shenzhen Huatongwei International Inspection Co., Ltd.	
Laboratory Location	1/F, Bldg 3, Hongfa Hi-tech Industrial Park, Genyu Road, Tianliao, Gongming, Shenzhen, China	
Connect information:	Tel: 86-755-26715499 E-mail: cs@szhtw.com.cn http://www.szhtw.com.cn	
Qualifications	Type	Accreditation Number
	FCC	762235

4.2. Environmental conditions

During the measurement the environmental conditions were within the listed ranges:

Normal Temperature:	25°C
Relative Humidity	55 %
Air Pressure	989 hPa

4.3. Statement of the measurement uncertainty

The data and results referenced in this document are true and accurate. The reader is cautioned that there may be errors within the calibration limits of the equipment and facilities. The measurement uncertainty was calculated for all measurements listed in this test report acc. to CISPR 16 - 4 „Specification for radio disturbance and immunity measuring apparatus and methods – Part 4: Uncertainty in EMC Measurements and is documented in the Shenzhen Huatongwei International Inspection Co., Ltd quality system acc. to DIN EN ISO/IEC 17025. Furthermore, component and process variability of devices similar to that tested may result in additional deviation. The manufacturer has the sole responsibility of continued compliance of the device.

Hereafter the best measurement capability for Shenzhen Huatongwei laboratory is reported:

Test Item	Range	Measurement Uncertainty	Notes
Radiated Emission	30~1000MHz	4.22dB	*
Radiated Emission	1~18GHz	5.06 dB	*
Conducted Disturbance	0.15~30MHz	3.39 dB	*
Harmonic Current Emissions	-	3.25%	*
Voltage Fluctuations and Flicker	-	4.26%	*
Radio frequency electromagnetic field	80-6000MHz	12.3%	*
Radio frequency, common mode	0.15-80MHz	16.8%	*
Electrostatic Discharge	-	-	*
Fast Transients Common Mode	-	-	*
Surges, Line to Line and Line to Ground	-	-	*

*This uncertainty represents an expanded uncertainty expressed at approximately the 95% confidence level using a coverage factor of k=2.

4.4. Equipments Used during the Test

● Conducted Emission							
Used	Test Equipment	Manufacturer	Equipment No.	Model No.	Serial No.	Last Cal. Date (YY-MM-DD)	Next Cal. Date (YY-MM-DD)
●	Shielded Room	Albatross projects	HTWE0114	N/A	N/A	2018/09/28	2023/09/27
●	EMI Test Receiver	R&S	HTWE0111	ESCI	101247	2021/09/14	2022/09/13
●	Artificial Mains	SCHWARZBECK	HTWE0113	NNLK 8121	573	2021/09/17	2022/09/16
●	Pulse Limiter	R&S	HTWE0193	ESH3-Z2	101447	2021/09/16	2022/09/15
●	RF Connection Cable	HUBER+SUHNER	HTWE0113-02	ENVIROFLEX_142	EF-NM-BNCM-2M	2021/09/17	2022/09/16
●	Test Software	R&S	N/A	ES-K1	N/A	N/A	N/A

● Radiated Emission-6th test site							
Used	Test Equipment	Manufacturer	Equipment No.	Model No.	Serial No.	Last Cal. Date (YY-MM-DD)	Next Cal. Date (YY-MM-DD)
●	Semi-Anechoic Chamber	Albatross projects	HTWE0127	SAC-3m-02	C11121	2018/09/30	2022/09/29
●	EMI Test Receiver	R&S	HTWE0099	ESCI	100900	2021/09/14	2022/09/13
●	Ultra-Broadband Antenna	SCHWARZBECK	HTWE0119	VULB9163	546	2020/04/28	2023/04/27
●	Pre-Amplifier	SCHWARZBECK	HTWE0295	BBV 9742	N/A	2021/11/05	2022/11/04
●	RF Connection Cable	HUBER+SUHNER	HTWE0062-01	N/A	N/A	2022/02/25	2023/02/24
●	RF Connection Cable	HUBER+SUHNER	HTWE0062-02	SUCOFLEX104	501184/4	2022/02/25	2023/02/24
●	Test Software	R&S	N/A	ES-K1	N/A	N/A	N/A

● Radiated emission-7th test site							
Used	Test Equipment	Manufacturer	Equipment No.	Model No.	Serial No.	Last Cal. Date (YY-MM-DD)	Next Cal. Date (YY-MM-DD)
●	Semi-Anechoic Chamber	Albatross projects	HTWE0122	SAC-3m-01	C11121	2018/09/27	2022/09/26
●	Spectrum Analyzer	R&S	HTWE0098	FSP40	100597	2021/09/13	2022/09/12
●	Horn Antenna	SCHWARZBECK	HTWE0126	9120D	1011	2020/04/01	2023/03/31
●	Broadband Pre-amplifier	SCHWARZBECK	HTWE0201	BBV 9718	9718-248	2022/02/28	2023/02/27
●	RF Connection Cable	HUBER+SUHNER	HTWE0126-01	RE-7-FH	N/A	2022/03/04	2023/03/03
●	Test Software	Audix	N/A	E3	N/A	N/A	N/A

● Electrostatic Discharge							
Used	Test Equipment	Manufacturer	Equipment No.	Model No.	Serial No.	Last Cal. Date (YY-MM-DD)	Next Cal. Date (YY-MM-DD)
●	ESD Simulator	EM TEST	HTWE0500	ESD NX30.1	11971	2021/07/21	2022/07/20

● Radio Frequency Electromagnetic Field							
Used	Test Equipment	Manufacturer	Equipment No.	Model No.	Serial No.	Last Cal. Date (YY-MM-DD)	Next Cal. Date (YY-MM-DD)
●	Semi-Anechoic Chamber	Albatross projects	HTWE0127	SAC-3m-02	C11121	2018/09/30	2022/09/29
●	Signal Generator	R&S	HTWE0276	SMB100A	114360	2021/08/05	2022/08/04
●	Amplifier	R&S	HTWE0277	BBA150-BC500	102664	2021/08/18	2022/08/17
●	Amplifier	R&S	HTWE0395	BBA150 D400	104197	2021/07/29	2022/07/29
●	Amplifier	R&S	HTWE0396	BBA150 E400	104198	2021/07/29	2022/07/29
●	Power Head	R&S	HTWE0278	NRP18A	101010	2021/08/05	2022/08/04
●	Power Head	R&S	HTWE0389	NRP18A	2021/05/27	2022/05/26	2021/05/27
●	Transmit Antenna	Schwarzbeck	HTWE0280	STLP9129	2022/03/30	2023/03/29	2022/03/30
●	Field Probe	ETS-LINDGREN	HTWE0321	HI-6153	2019/05/23	2022/05/22	2019/05/23
●	Test Software	R&S	N/A	EMC32	100916	N/A	N/A
○	Audio analyzer	R&S	HTWE3008	UPV	101371	2021/10/09	2022/10/08
○	Radio communication tester	R&S	HTWE0287	CMW500	137688-Lv	2021/09/13	2022/09/12
○	RF Communication Test Set	HP	HTWE0038	8920A	3813A10206	2021/09/13	2022/09/12
○	Digital intercom communication tester	Aeroflex	HTWE0255	3920B	1001682041	2021/09/13	2022/09/12

● Electrical fast transient/burst immunity test, Surge immunity test							
Used	Test Equipment	Manufacturer	Equipment No.	Model No.	Serial No.	Last Cal. Date (YY-MM-DD)	Next Cal. Date (YY-MM-DD)
●	Transient immunity simulator	EM TEST	HTWE0512	compact NX5	P2128254484	2021/07/14	2022/07/13
●	3-Phase Coupling Network	EM TEST	HTWE0516	coupling NX5	P2125254008	2021/07/13	2022/07/12
●	Coupling Clamp	EM TEST	HTWE0513	CCI	P2125253835	2021/06/30	2022/06/29
○	4-Lines Coupling Network	EM TEST	HTWE0514	DCD 5 SR-4-1	P2128254471	2021/07/14	2022/07/13
○	8-Lines Coupling Network	EM TEST	HTWE0515	DCD 5 ST-4-1	P2128254472	2021/07/15	2022/07/14
●	Test Software	EM TEST	N/A	ISM IEC	N/A	N/A	N/A

● Radio frequency (common mode)							
Used	Test Equipment	Manufacturer	Equipment No.	Model No.	Serial No.	Last Cal. Date (YY-MM-DD)	Next Cal. Date (YY-MM-DD)
●	Signal Generator	IFR	HTWE0022	2023A	202304/060	2021/09/17	2022/09/16
●	Amplifier	AR	HTWE0023	75A250	302205	2021/09/17	2022/09/16
●	6db Attenuator	EMTEST	HTWE0025	ATT6/75	0010230A	2020/10/15	2022/10/14
○	EM Clamp	LÜTHI	HTWE0028	EM101	335625	2021/09/17	2022/09/16
●	Test Software	AR	N/A	SW1004	N/A	N/A	N/A
○	CDN	EMTEST	HTWE0155	CDN M3	0802-03	2021/09/14	2022/09/13
○	CDN	EMTEST	HTWE0154	CDN M2	51001001001 2	2021/09/14	2022/09/13
○	CDN	EMTEST	HTWE0153	CDN M1/32A	0202-05	2021/09/14	2022/09/13
○	CDN	EMTEST	HTWE0156	CDN M4-N/32A	51001066000 1	2021/09/14	2022/09/13
○	Audio analyzer	R&S	HTWE3008	UPV	101371	2021/10/09	2022/10/08
○	Radio communication tester	R&S	HTWE0287	CMW500	137688-Lv	2021/09/13	2022/09/12
●	RF Communication Test Set	HP	HTWE0038	8920A	3813A10206	2021/09/13	2022/09/12
●	Digital intercom communication tester	Aeroflex	HTWE0255	3920B	1001682041	2021/09/13	2022/09/12

● Voltage Dips and Interruptions							
Used	Test Equipment	Manufacturer	Equipment No.	Model No.	Serial No.	Last Cal. Date (YY-MM-DD)	Next Cal. Date (YY-MM-DD)
●	Transient immunity simulator	EM TEST	HTWE0512	compact NX5	P212825448 4	2021/07/14	2022/07/13
●	Motor Driven Voltage Transformer	EM TEST	HTWE0008	MV2616	0301-11	2021/07/14	2022/07/13
●	Test Software	EM TEST	N/A	ISM IEC	N/A	N/A	N/A

● Auxiliary Equipment							
Used	Test Equipment	Manufacturer	Equipment No.	Model No.	Serial No.	Last Cal. Date (YY-MM-DD)	Next Cal. Date (YY-MM-DD)
○	Radio communication tester	R&S	HTWE0287	CMW500	137688-Lv	2021/09/13	2022/09/12
●	RF Communication Test Set	HP	HTWE0038	8920A	3813A10206	2021/09/13	2022/09/12
●	Digital intercom communication tester	Aeroflex	HTWE0255	3920B	1001682041	2021/09/13	2022/09/12

5. Test conditions and Results

5.1. EMISSION

5.1.1. Conducted Emissions

LIMIT

Please refer to IEC60945 Clause 9.1, Table 5

Conducted emissions (9.2)	10 kHz – 150 kHz	63 mV – 0,3 mV (96 dB μ V – 50 dB μ V)
	150 kHz – 350 kHz	1 mV – 0,3 mV (60 dB μ V – 50 dB μ V)
	350 kHz – 30 MHz	0,3 mV (50 dB μ V)

TEST CONFIGURATION

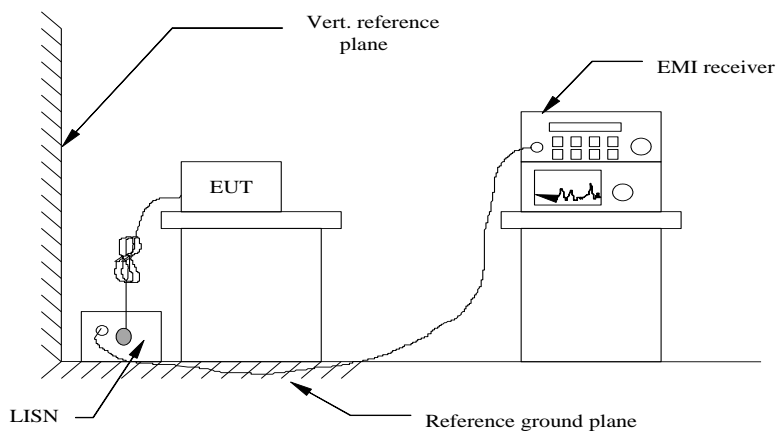

TEST PROCEDURE

Please refer to IEC60945 Clause 9.2.2 for the measurement methods

TEST MODE:

Please reference to the section 3.3

TEST RESULTS

Passed Not Applicable

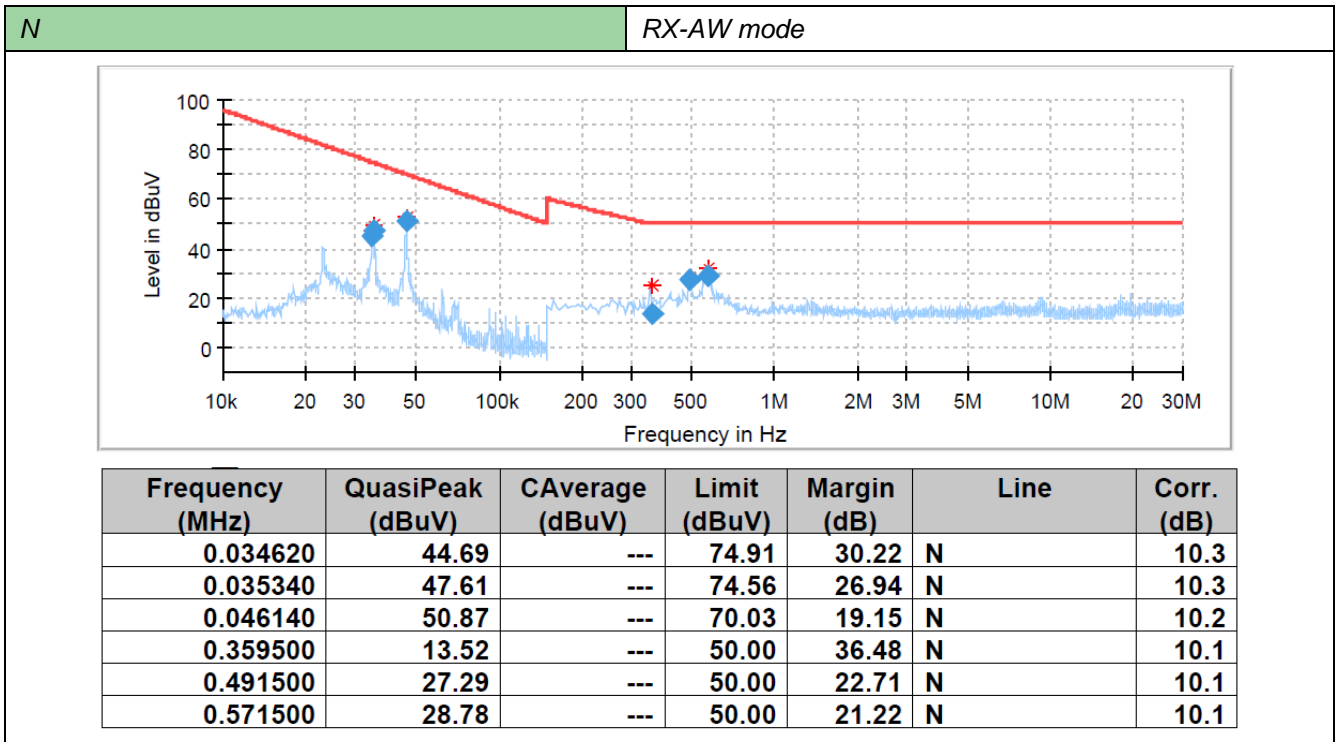
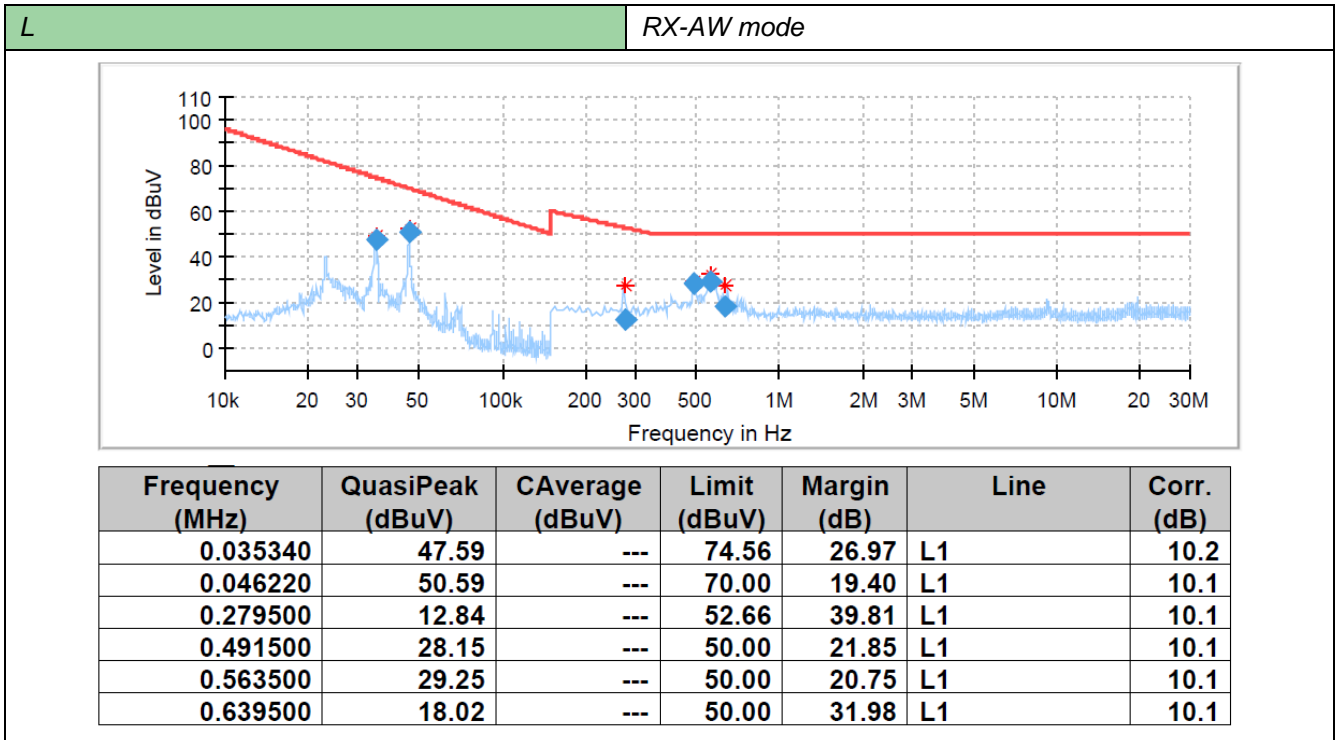

5.1.2. Radiated Emission

LIMIT

Please refer to IEC60945 Clause 9.1, Table 5

Radiated emissions (9.3)	150 kHz – 300 kHz	10 mV/m – 316 μ V/m (80 dB μ V/m – 52 dB μ V/m)
	300 kHz – 30 MHz	316 μ V/m – 50 μ V/m (52 dB μ V/m – 34 dB μ V/m)
	30 MHz – 2 GHz	500 μ V/m (54 dB μ V/m) except for
	156 MHz – 165 MHz	16 μ V/m (24 dB μ V/m) quasi-peak or 32 μ V/m (30 dB μ V/m) peak

TEST CONFIGURATION

➤ below 30MHz:

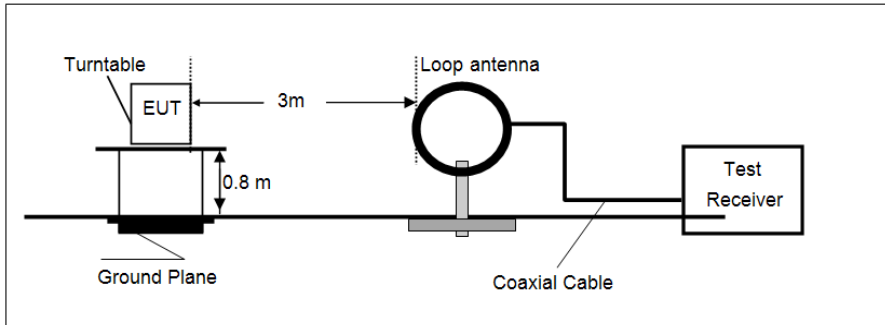

➤ Above 30MHz

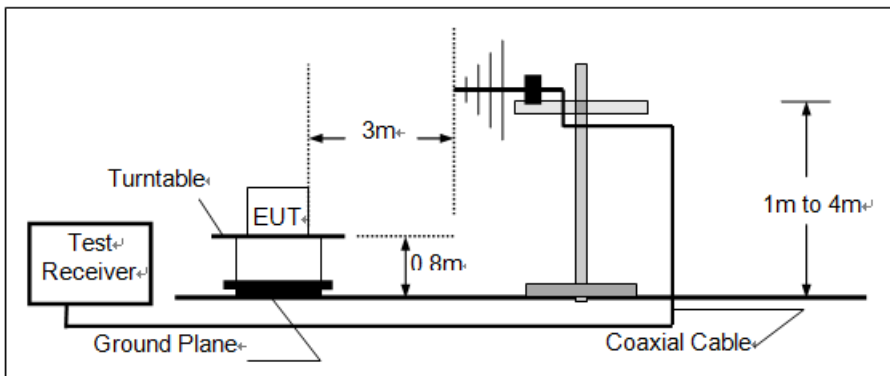

TEST PROCEDURE

Please refer to IEC60945 Clause 9.3.2 for the measurement methods

TEST MODE:

Please refer to the Clause 3.3

TEST RESULTS

Passed Not Applicable

RX-AW mode

Polarization

150K-30MHz

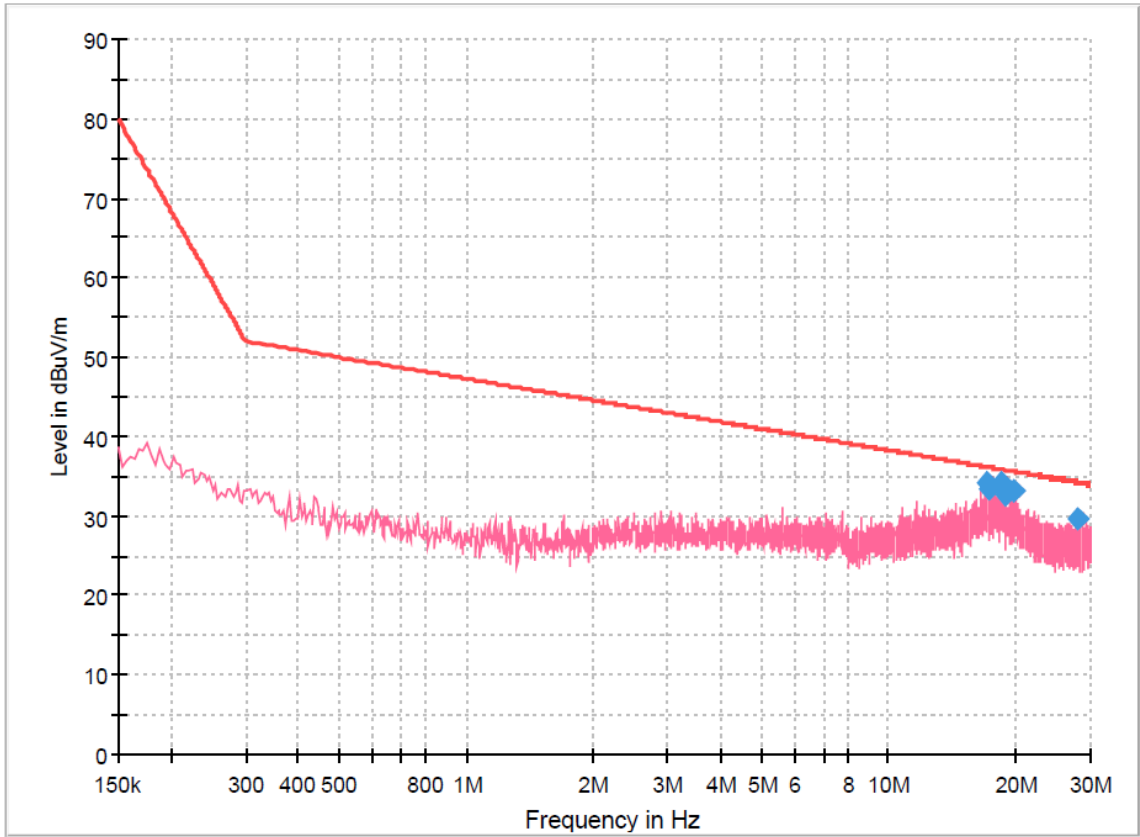

Frequency (MHz)	MaxPeak (dBuV/m)	Limit (dBuV/m)	Margin (dB)	Pol	Azimuth (deg)	Corr. (dB/m)	Comment
17.112263	34.08	36.19	2.11	V	152.0	21.0	11:17:53 am - 07/06/2022
17.313750	33.34	36.15	2.80	V	49.0	21.0	11:17:53 am - 07/06/2022
18.559988	34.07	35.88	1.80	V	152.0	21.0	11:17:53 am - 07/06/2022

Frequency (MHz)	MaxPeak (dBuV/m)	Limit (dBuV/m)	Margin (dB)	Pol	Azimuth (deg)	Corr. (dB/m)	Comment
18.925650	32.73	35.80	3.07	V	250.0	21.0	11:17:53 am - 07/06/2022
19.884581	33.20	35.61	2.41	V	82.0	21.0	11:17:53 am - 07/06/2022
28.097063	29.68	34.26	4.57	V	294.0	21.1	11:17:53 am - 07/06/2022

RX-AW mode

Polarization Vertical

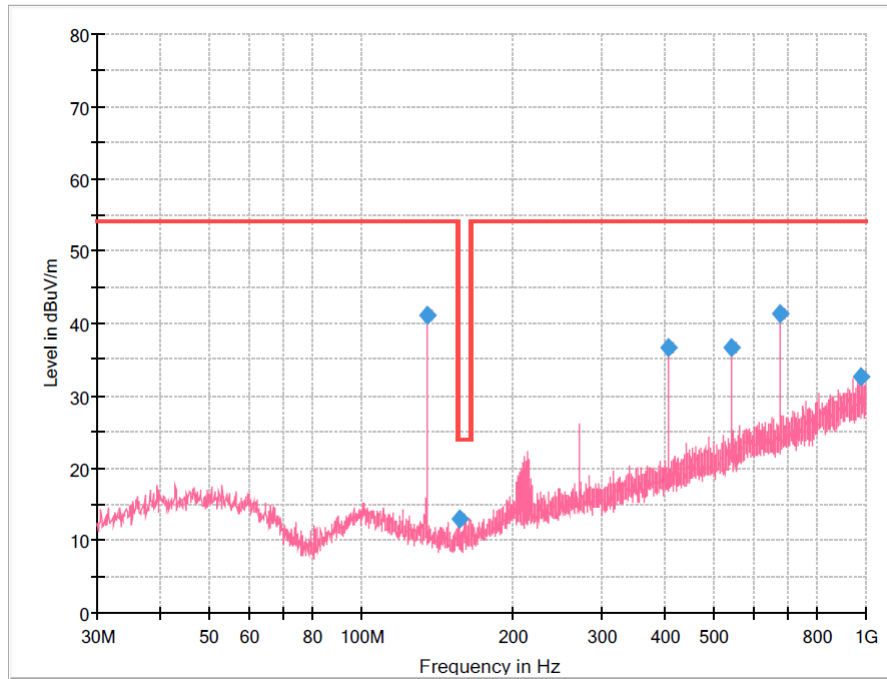

Frequency (MHz)	QP (dBuV/m)	Limit (dBuV/m)	Margin (dB)	Height (cm)	Pol	Azimuth (deg)	Corr. (dB/m)
135.123750	41.09	54.00	12.91	100.0	V	273.0	-14.1
156.221250	12.98	24.00	11.02	100.0	V	243.0	-13.6
405.390000	36.61	54.00	17.39	100.0	V	155.0	-4.1
540.462500	36.70	54.00	17.30	100.0	V	26.0	-0.4
675.535000	41.32	54.00	12.68	100.0	V	349.0	2.1
978.175000	32.53	54.00	21.47	100.0	V	56.0	8.0

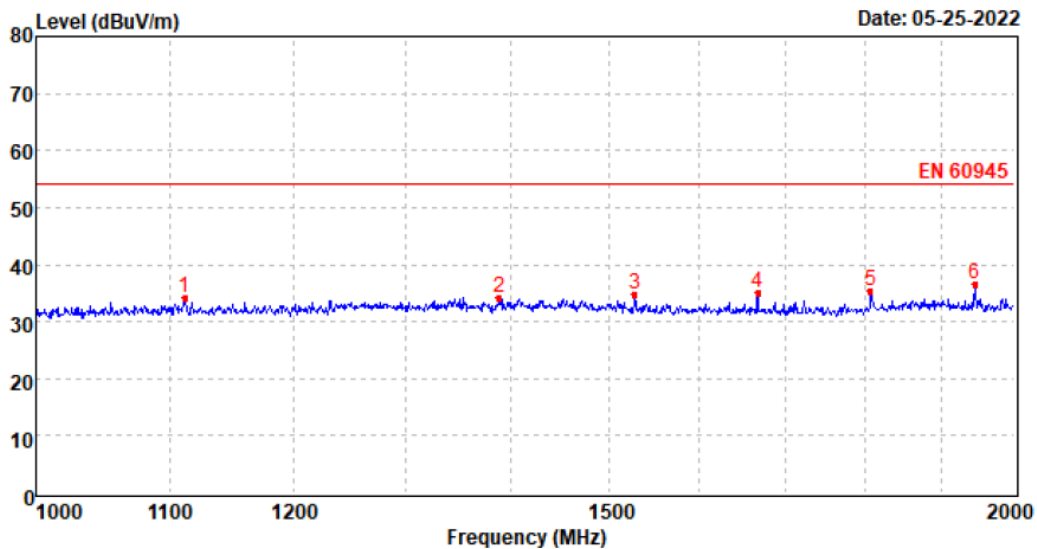

Mark	Frequency MHz	Reading dBuV/m	Antenna dB	Cable dB	Preamp dB	Level dBuV/m	Limit dBuV/m	Over limit	Remark
1	1111.11	42.05	25.40	3.72	37.07	34.10	54.00	-19.90	Peak
2	1388.96	40.34	26.14	4.16	36.52	34.12	54.00	-19.88	Peak
3	1528.38	41.62	25.67	4.37	36.90	34.76	54.00	-19.24	Peak
4	1667.86	42.57	25.10	4.57	37.14	35.10	54.00	-18.90	Peak
5	1806.25	42.30	25.43	4.76	37.10	35.39	54.00	-18.61	Peak
6	1945.31	43.05	25.89	4.95	37.18	36.71	54.00	-17.29	Peak

RX-AW mode

Polarization

Horizontal

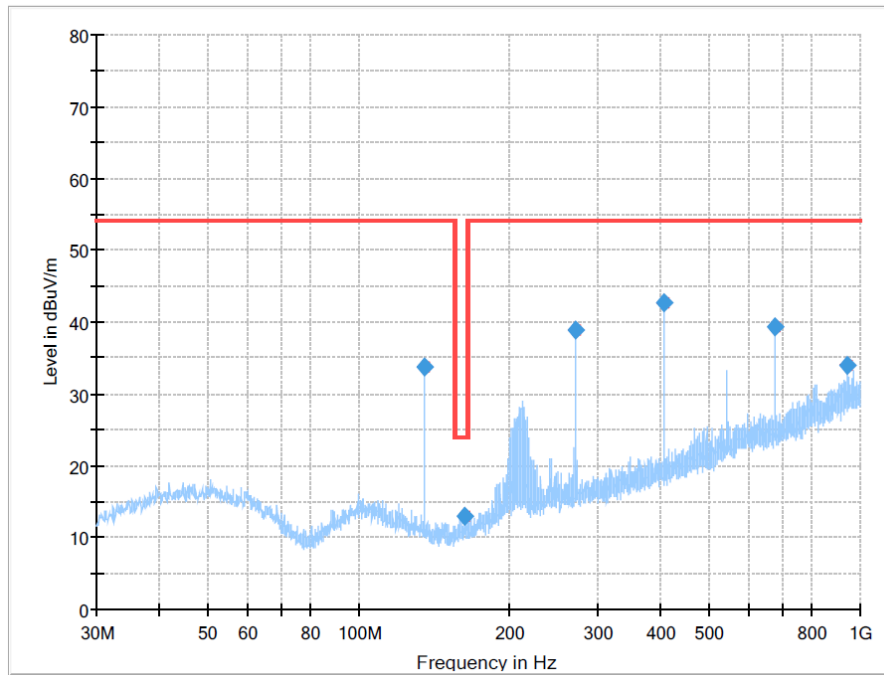

Frequency (MHz)	QP (dBuV/m)	Limit (dBuV/m)	Margin (dB)	Height (cm)	Pol	Azimuth (deg)	Corr. (dB/m)
135.123750	33.84	54.00	20.16	100.0	H	263.0	-14.1
162.768750	12.86	24.00	11.14	300.0	H	322.0	-13.3
270.196250	38.84	54.00	15.16	100.0	H	105.0	-8.4
405.390000	42.72	54.00	11.28	100.0	H	214.0	-4.1
675.535000	39.32	54.00	14.68	100.0	H	120.0	2.1
945.801250	34.05	54.00	19.95	100.0	H	303.0	7.6

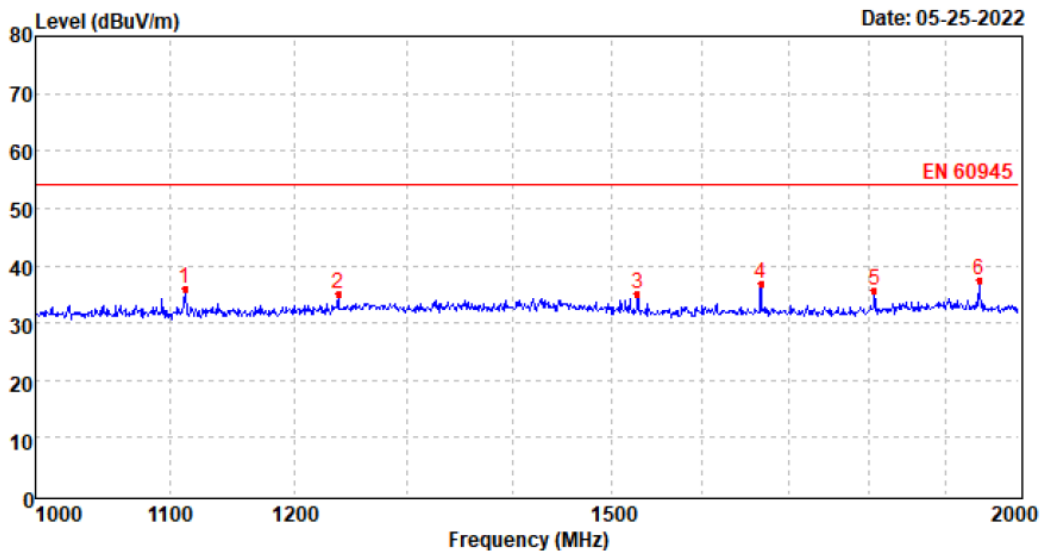

Mark	Frequency MHz	Reading dBuV/m	Antenna dB	Cable dB	Preamp dB	Level dBuV/m	Limit dBuV/m	Over limit	Remark
1	1111.11	43.81	25.40	3.72	37.07	35.86	54.00	-18.14	Peak
2	1237.99	42.01	25.83	3.93	36.71	35.06	54.00	-18.94	Peak
3	1528.38	41.96	25.67	4.37	36.90	35.10	54.00	-18.90	Peak
4	1667.86	44.40	25.10	4.57	37.14	36.93	54.00	-17.07	Peak
5	1806.25	42.63	25.43	4.76	37.10	35.72	54.00	-18.28	Peak
6	1945.31	43.73	25.89	4.95	37.18	37.39	54.00	-16.61	Peak

5.2. IMMUNITY

Performance criteria

No change of the actual operational states of the test objects is allowed. However, temporary change is allowed during the power supply failure test.

In addition, the following generic acceptance criteria for compliance were in force during the EMC immunity testing:

- Performance Criterion A: (For continuous phenomena): The EUT shall continue to operate as intended during and after the test. No degradation of performance or loss of function is allowed as defined in the relevant equipment standard and in the technical specification published by the manufacturer.
- Performance Criterion B: (For transient phenomena): The EUT shall continue to operate as intended after the tests. No degradation of performance or loss of function is allowed as defined in the technical specification published by the manufacturer. During the test, degradation or loss of function or performance which is self-recoverable is, however, allowed but no change of actual operating state or stored data is allowed.
- Performance Criterion C: Temporary degradation or loss of function or performance is allowed during and after the test, provided the function is self-recoverable, or can be restored by the operation of the controls as defined in the relevant equipment standard and in the technical specification published by the manufacturer.

5.2.1. Conducted radio frequency disturbance

PERFORMANCE CRITERION

Performance criterion: A.

TEST CONFIGURATION

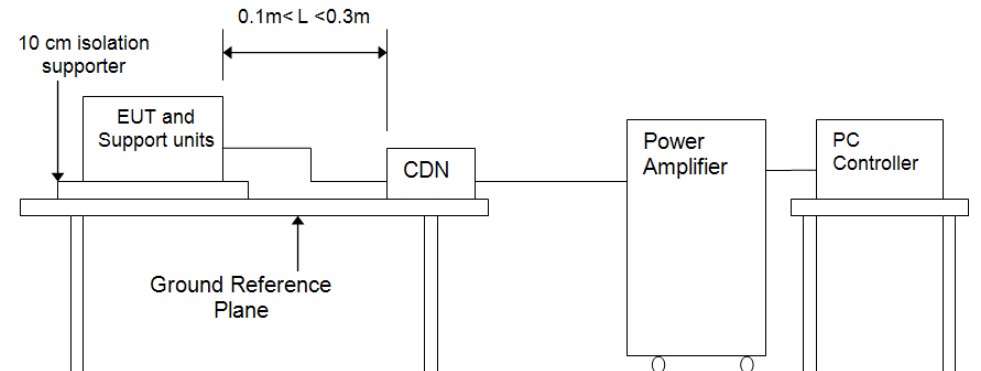

TEST PROCEDURE

Please refer to IEC60945 Clause 10.3.2 for the measurement methods

TEST MODE

Please reference to the section 3.3

TEST RESULTS

Passed Not Applicable

Please refer to the below test data:

Test mode	All modes				
Frequency	Injected Position	Level	Modulation	Observations (Performance Criterion)	Result
150kHz to 80MHz	DC Power Line	10Vrms	400 Hz sine wave, 80 % AM, 1 % increment, dwell time=3seconds	A	Pass

Note:

A: No degradation in performance of the EUT was observed.

5.2.2. Radiated radio frequencies

PERFORMANCE CRITERION

Criteria A

TEST CONFIGURATION

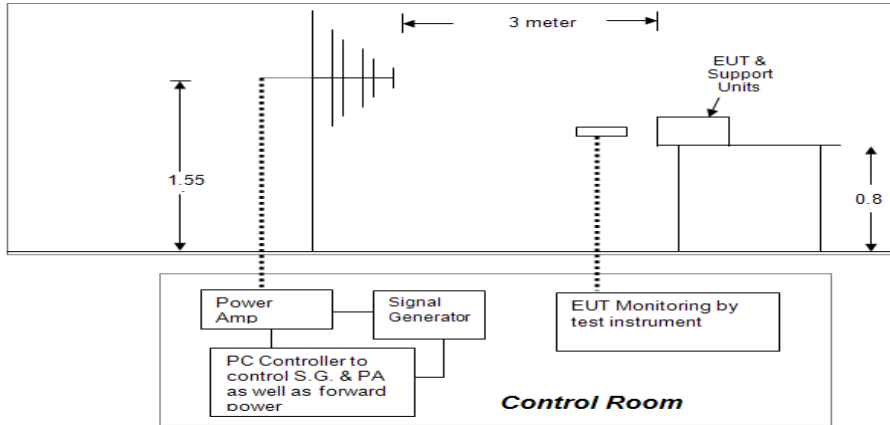

TEST PROCEDURE

Please refer to IEC60945 Clause 10.4.2 for the measurement methods

TEST MODE

Please reference to the section 3.3

TEST RESULTS

Passed **Not Applicable**

Please refer to the below test data:

Test mode	All modes					
Frequency	Level	Modulation	Antenna Polarization	EUT Face	Observations (Performance Criterion)	Result
80 MHz-2 GHz	10 V/m	400 Hz sine wave, 80 % AM, 1 % increment, dwell time=3seconds	V	Front	A	Pass
			H		A	Pass
			V	Rear	A	Pass
			H		A	Pass
			V	Left	A	Pass
			H		A	Pass
			V	Right	A	Pass
			H		A	Pass
			V	Top	A	Pass
			H		A	Pass
			V	Bottom	A	Pass
			H		A	Pass

Remark: A: No degradation in performance of the EUT was observed.

5.2.3. Power supply transients

PERFORMANCE CRITERION

Criteria B

TEST CONFIGURATION

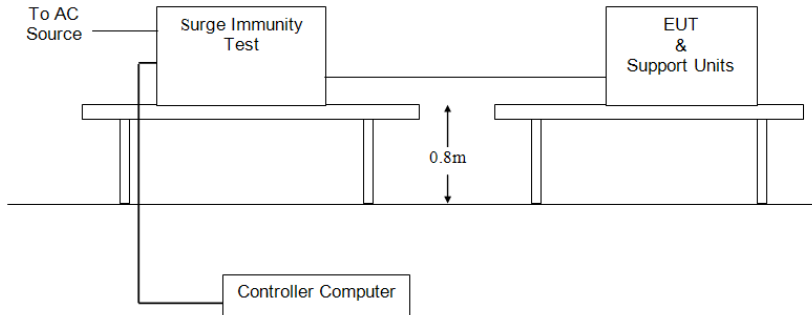

TEST PROCEDURE

Please refer to IEC60945 Clause 10.6.2 for the measurement methods

TEST MODE

Please reference to the section 3.3

TEST RESULTS

Passed Not Applicable

Note:EUT belongs to DC power supply

5.2.4. Power supply variations and failure

PERFORMANCE CRITERION

Criteria A for Power supply variations

Criteria C for Power supply failure

TEST CONFIGURATION

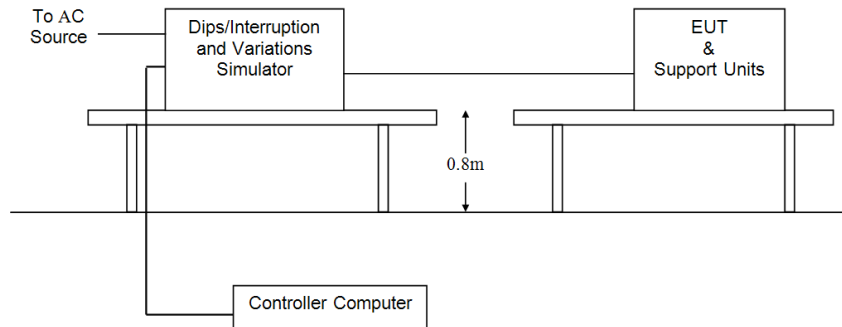

TEST PROCEDURE

Please refer to IEC60945 Clause 10.7.3 and 10.8.3 for the measurement methods

TEST MODE

Please reference to the section 3.3

TEST RESULTS

Passed Not Applicable

Note: EUT belongs to DC power supply

5.2.5. Electrostatic Discharge

PERFORMANCE CRITERION

Criteria B

TEST CONFIGURATION

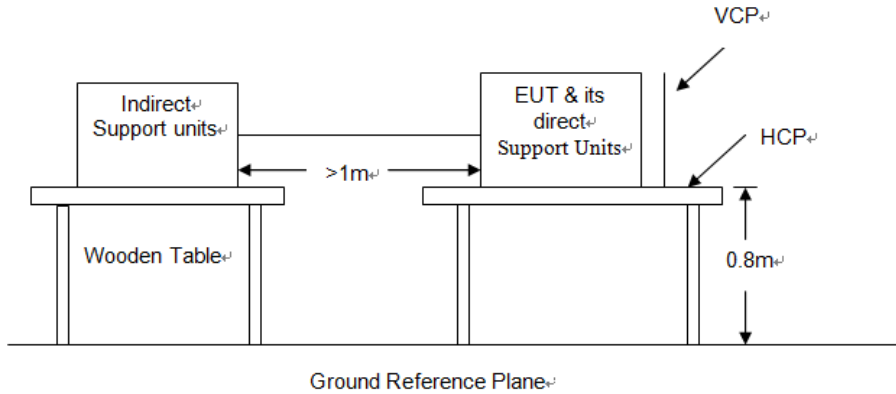

TEST PROCEDURE

Please refer to IEC60945 Clause 10.9.2 for the measurement methods

Contact Discharge:

The ESD generator is held perpendicular to the surface to which the discharge is applied and the tip of the discharge electrode touch the surface of EUT. Then turn the discharge switch. The generator is then re-triggered for a new single discharge and repeated at least 10 times for each pre-selected test point. This procedure shall be repeated until all the air discharge completed.

Air Discharge:

Air discharge is used where contact discharge can't be applied. The round discharge tip of the discharge electrode shall be approached as fast as possible to touch the EUT. After each discharge, the discharge electrode shall be removed from the EUT. The generator is then re-triggered for a new single discharge and repeated at least 10 times for each pre-selected test point. This procedure shall be repeated until all the air discharge completed.

Indirect discharge for horizontal coupling plane:

At least 10 single discharges shall be applied to the horizontal coupling plane, at points on each side of the EUT.

Indirect discharge for vertical coupling plane:

At least 10 single discharges shall be applied to the center of one vertical edge of the coupling plane. The coupling plane, of dimensions 0.5m X 0.5m, is placed parallel to, and positioned at a distance of 0.1m from the EUT. Discharges shall be applied to the coupling plane, with this plane in sufficient different positions that the four faces of the EUT are completely illuminated.

TEST MODE

Please reference to the section 3.3

TEST RESULTS

Passed Not Applicable

Test mode	All modes			
Direct discharge				
Type of discharge	Discharge voltage (kV)	Observations Performance	CriteriaLevel	Result
Contact discharge	±2	No degradation in performance of the EUT was observed (A)	B	Pass
	±4		B	
Air discharge	±2	B	B	
	±4	B	B	
	±8	B	B	
Indirect discharge				
Type of discharge	Discharge voltage (KV)	Observations Performance	CriteriaLevel	Result
HCP (6 sides)	±2	B	B	Pass
	±4	B	B	
VCP (4 sides)	±2	B	B	
	±4	B	B	

Description of Discharge Point

Contact discharge: →

Air discharge: →

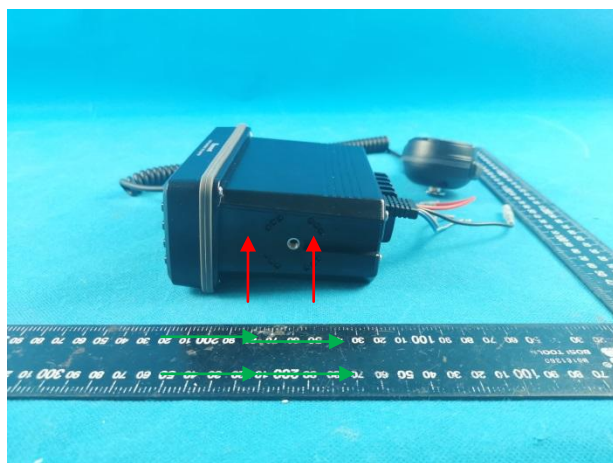
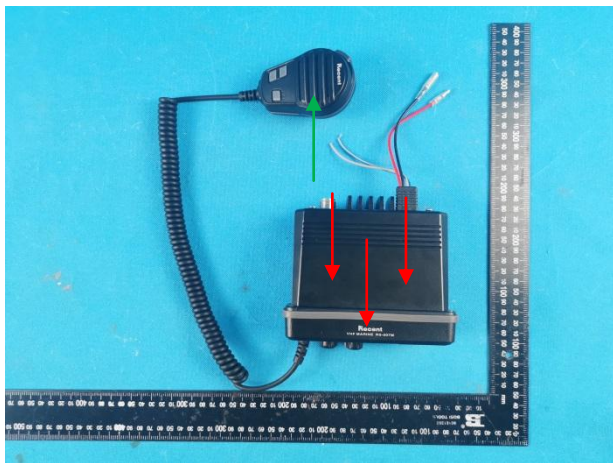

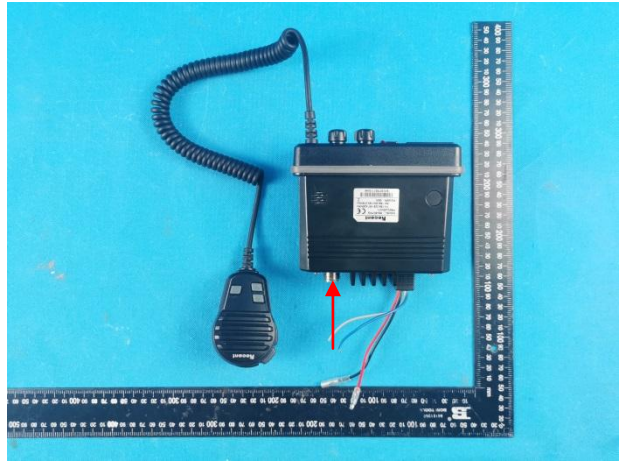
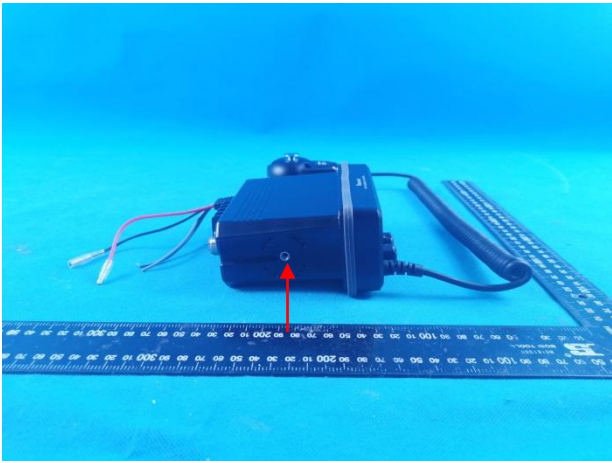

5.3. Environmental Test

5.3.1. Dry heat

TEST METHOD

Storage Test: The EUT shall be placed in a chamber at normal room temperature and relative humidity. The temperature shall then be raised to and maintained at $+70\text{ }^{\circ}\text{C} \pm 3\text{ }^{\circ}\text{C}$, for a period of 10 h to 16 h. At the end of the test, the EUT shall be returned to normal environmental conditions and then subjected to a performance check

Functional test: The EUT shall be placed in a chamber at normal room temperature and relative humidity. The EUT and, if appropriate, any climatic control devices with which it is provided shall then be switched on. The temperature shall then be raised to and maintained at $+55\text{ }^{\circ}\text{C} \pm 3\text{ }^{\circ}\text{C}$. At the end of a soak period of 10 h to 16 h at $+55\text{ }^{\circ}\text{C} \pm 3\text{ }^{\circ}\text{C}$, the EUT shall be subjected to a performance test and check.

The temperature of the chamber shall be maintained at $+55\text{ }^{\circ}\text{C} \pm 3\text{ }^{\circ}\text{C}$ during the whole performance test period. At the end of the test, the EUT shall be returned to normal environmental conditions.

TEST RESULTS

Passed Not Applicable

No degradation of performance or loss of function was observed.

5.3.2. Damp heat

TEST METHOD

Functional test: The EUT shall be placed in a chamber at normal room temperature and relative humidity. The temperature shall then be raised to $+40\text{ }^{\circ}\text{C} \pm 2\text{ }^{\circ}\text{C}$, and the relative humidity raised to $93\% \pm 3\%$ over a period of $3\text{ h} \pm 0,5\text{ h}$. These conditions shall be maintained for a period of 10 h to 16 h. Any climatic control devices provided in the EUT may be switched on at the conclusion of this period.

The EUT shall be switched on 30 min later, or after such period as agreed by the manufacturer, and shall be kept operational for at least 2 h during which period the EUT shall be subjected to a performance check as specified in the relevant equipment standard. The temperature and relative humidity of the chamber shall be maintained as specified during the whole test period. At the end of the test period and with the EUT still in the chamber, the chamber shall be brought to room temperature in not less than 1 h. At the end of the test the EUT shall be returned to normal environmental conditions.

TEST RESULTS

Passed Not Applicable

No degradation of performance or loss of function was observed.

5.3.3. Low temperature

TEST METHOD

Functional test: The EUT shall be subject to the conditions specified for portable equipment except that the temperature of the chamber shall be reduced to, and maintained at $-15\text{ °C} \pm 3\text{ °C}$. The EUT shall be switched on 30 min later, or after such period as agreed by the manufacturer, and shall be kept operational for at least 2 h during which period the EUT shall be subjected to a performance check test and check

TEST RESULTS

Passed Not Applicable

No degradation of performance or loss of function was observed.

5.3.4. Vibration

TEST METHOD

The EUT, complete with any shock and vibration absorbers with which it is provided, shall be fastened to the vibration table by its normal means of support and in its normal attitude. The EUT may be resiliently suspended to compensate for weight not capable of being withstood by the vibration table. Provision may be made to reduce or nullify any adverse effect on EUT performance which might be caused by the presence of an electromagnetic field due to the vibration unit.

The EUT shall be subjected to sinusoidal vertical vibration at all frequencies between:

– 2 Hz to 5 Hz and up to 13,2 Hz with an excursion of $\pm 1\text{ mm} \pm 10\%$

(7 m/s² maximum acceleration at 13,2 Hz);

– above 13,2 Hz and up to 100 Hz with a constant maximum acceleration of 7 m/s².

The frequency sweep rate shall be 0,5 octaves/min in order to allow the detection of resonances in any part of the EUT as mounted.

A resonance search shall be carried out throughout the test. During the resonance search the EUT shall be externally observed, by unaided visual and aural means, for obvious signs of any resonances of components or sub-assemblies, that may affect the integrity of the EUT. Such observations shall be recorded in the test report. If any resonance, as measured by a sensor fixed to the outside of the EUT at the location where obvious signs of resonance have been observed, has a magnitude ratio ≥ 5 measured relative to the surface where the EUT is fastened, the EUT shall be subjected to a vibration endurance test at each resonant frequency at the vibration level specified in the test with a duration of 2 h. When resonant frequencies with magnitude ratios ≥ 5 are harmonically related, only the fundamental frequency shall be tested. If no resonance with a magnitude ratio ≥ 5 occurs, the endurance test shall be carried out at one single observed frequency. If no resonance occurred, the endurance test shall be carried out at a frequency of 30 Hz. Performance check(s) shall be carried out at least once during each endurance test period, and once before the end of each endurance test period.

TEST RESULTS

Passed Not Applicable

No degradation of performance or loss of function was observed.

6. Test Setup Photos

Radiated Emission

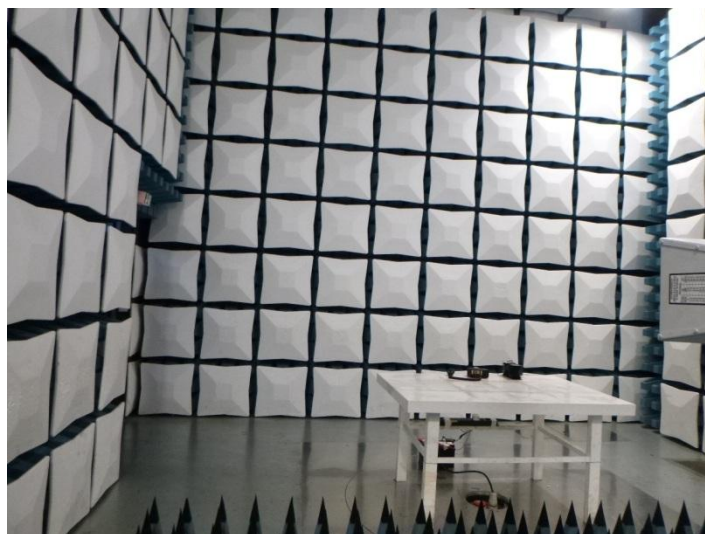

Conducted Emission

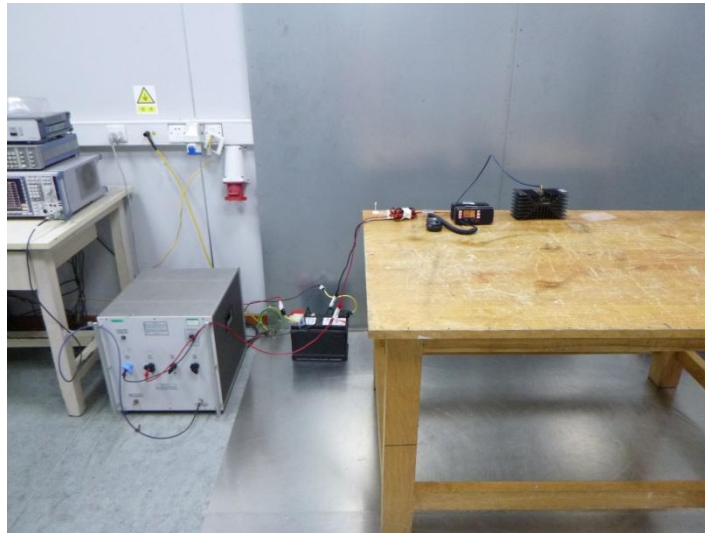

Electrostatic Discharge



Radiated disturbance

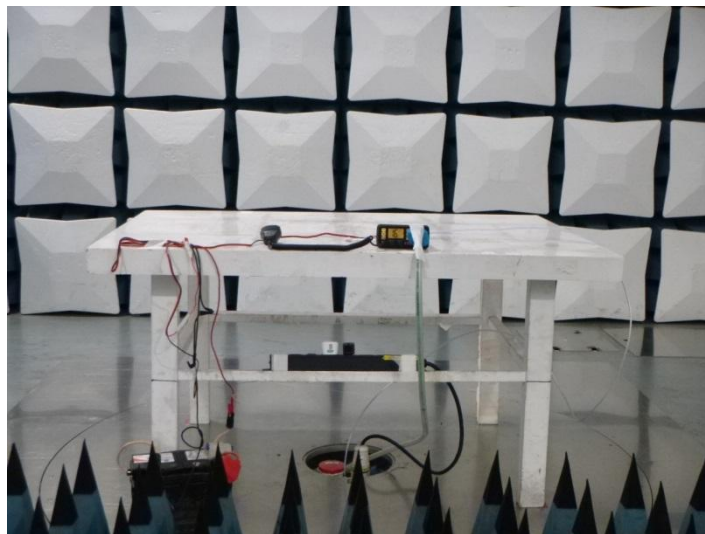

7. External and Internal Photos of the EUT

Reference to the test report No.: CHTEW22060048

-----End of Report-----