



TEST REPORT

Report Reference No.....: **CHEW22060050** Report Verification: 

Project No.....: **SHT2204047901EW**

FCC ID.....: **2A3OORM20**

Applicant's name.....: **Shenzhen Ysair Technology Co., LTD**

Address: 6/F, building 6, Yunli intelligent park, No. 3, Changfa Middle Road, Yangmei community, Bantian street, Longgang District, Shenzhen, Guangdong, China

Test item description: **VHF Marine Radio**

Trade Mark: RETEVIS

Model/Type reference: RM20

Listed Model(s).....: -

Standard: **IEC 62238**

Date of receipt of test sample.....: Apr.27, 2022

Date of testing.....: Apr.28, 2022-Jun.06, 2022

Date of issue.....: Jun.07, 2022

Result: **PASS**

Compiled by
 (position+printed name+signature) : File administrators Fanghui Zhu 

Supervised by
 (position+printed name+signature) : Project Engineer Cheng Xiao 

Approved by
 (position+printed name+signature) ...: RF Manager Hans Hu 

Testing Laboratory Name: **Shenzhen Huatongwei International Inspection Co., Ltd**

Address: 1/F, Bldg 3, Hongfa Hi-tech Industrial Park, Genyu Road, Tianliao, Gongming, Shenzhen, China

Shenzhen Huatongwei International Inspection Co., Ltd. All rights reserved.

This publication may be reproduced in whole or in part for non-commercial purposes as long as the Shenzhen Huatongwei International Inspection Co., Ltd. is acknowledged as copyright owner and source of the material. Shenzhen Huatongwei International Inspection Co., Ltd. takes no responsibility for and will not assume liability for damages resulting from the reader's interpretation of the reproduced material due to its placement and context.

The test report merely correspond to the test sample.

Contents

1.	<u>TEST STANDARDS AND REPORT VERSION</u>	4
1.1.	Test Standards	4
1.2.	Report version information	4
2.	<u>TEST DESCRIPTION</u>	5
3.	<u>SUMMARY</u>	7
3.1.	Client Information	7
3.2.	Product Description	7
3.3.	Test frequency list	8
3.4.	EUT operation mode	8
3.5.	EUT configuration	8
4.	<u>TEST ENVIRONMENT</u>	9
4.1.	Address of the test laboratory	9
4.2.	Test Facility	9
4.3.	Environmental conditions	10
4.4.	Statement of the measurement uncertainty	11
4.5.	Equipments Used during the Test	12
5.	<u>TEST CONDITIONS AND RESULTS</u>	13
5.1.	Environmental Requirement	13
5.1.1.	Vibration test	13
5.1.2.	Dry heat	14
5.1.3.	Damp heat	15
5.1.4.	Low temperature	16
5.2.	Transmitter Requirement	17
5.2.1.	Frequency error	17
5.2.2.	Carrier Power (Conducted)	18
5.2.3.	Frequency Deviation	19
5.2.4.	Sensitivity of the modulator, including microphone	21
5.2.5.	Audio frequency response	22
5.2.6.	Audio frequency harmonic distortion of the emission	23
5.2.7.	Adjacent Channel Power	24
5.2.8.	Conducted spurious emissions conveyed to the antenna	25
5.2.9.	Transient frequency behaviour of the transmitter	26
5.2.10.	Residual modulation of the transmitter	27
5.2.11.	Frequency error (demodulated DSC signal)	28
5.2.12.	Modulation index for DSC	29
5.2.13.	Modulation rate for DSC	30
5.2.14.	Testing of generated call sequences	31
5.3.	Receiver for Radiotelephone Requirement	32
5.3.1.	Harmonic distortion and rated audio frequency output power	32
5.3.2.	Audio frequency response	33
5.3.3.	Maximum Usable Sensitivity	34
5.3.4.	Co-channel rejection	35
5.3.5.	Adjacent channel selectivity	36
5.3.6.	Spurious Response Rejection	37
5.3.7.	Intermodulation response	38
5.3.8.	Blocking or Desensitization	39
5.3.9.	Conducted spurious emissions	40
5.3.10.	Receiver noise and hum level	41

5.3.11.	Squelch operation	42
5.3.12.	Squelch hysteresis	43
5.3.13.	Multiple watch characteristic	44
5.4.	Receiver for DSC decoder Requirement	45
5.4.1.	Maximum usable sensitivity	45
5.4.2.	Co-channel rejection	46
5.4.3.	Adjacent channel selectivity	47
5.4.4.	Spurious response and blocking immunity	48
5.4.5.	Intermodulation response	49
5.4.6.	Dynamic range	50
5.4.7.	Spurious emissions	51
5.4.8.	Verification of correct decoding of various types of DSC calls	52
5.4.9.	Reaction to VTS and AIS channel management DSC transmissions	52
5.4.10.	Simultaneous reception	53
6.	<u>EXTERNAL AND INTERNAL PHOTOS OF THE EUT</u>	53

1. TEST STANDARDS AND REPORT VERSION

1.1. Test Standards

The tests were performed according to following standards:

[IEC 62238:2003](#)-Maritime navigation and radiocommunication equipment and systems –VHF radiotelephone equipment incorporating Class "D" Digital Selective Calling (DSC) – Methods of testing and required test results

1.2. Report version information

Revision No.	Date of issue	Description
N/A	2022-06-07	Original

2. Test Description

Environmental Requirement			
Test item	Standards requirement (IEC62238)	Result	Test Engineer
Vibration test	Sub-clause 7.4	Pass	Caspar Chen
Temperature tests	Dry heat	Pass	Caspar Chen
	Damp heat	Pass	Caspar Chen
	Low temperature	Pass	Caspar Chen
Transmitter Requirement			
Test item	Standards requirement (IEC62238)	Result	Test Engineer
Frequency error	Sub-clause 8.1	Pass	Caspar Chen
Carrier power	Sub-clause 8.2	Pass	Caspar Chen
Frequency deviation	Sub-clause 8.3	Pass	Caspar Chen
Sensitivity of the modulator, including microphone	Sub-clause 8.4	Pass	Caspar Chen
Audio frequency response	Sub-clause 8.5	Pass	Caspar Chen
Audio frequency harmonic distortion of the emission	Sub-clause 8.6	Pass	Caspar Chen
Adjacent channel power	Sub-clause 8.7	Pass	Caspar Chen
Conducted spurious emissions conveyed to the antenna	Sub-clause 8.8	Pass	Caspar Chen
Transient frequency behaviour of the transmitter	Sub-clause 8.9	Pass	Caspar Chen
Residual modulation of the transmitter	Sub-clause 8.10	Pass	Caspar Chen
Frequency error (DSC signal)	Sub-clause 8.11	Pass	Caspar Chen
Modulation index for DSC	Sub-clause 8.12	Pass	Caspar Chen
Modulation rate for DSC	Sub-clause 8.13	Pass	Caspar Chen
Testing of generated call sequences	Sub-clause 8.14	Pass	Caspar Chen
Receiver for Radiotelephone Requirement			
Test item	Standards requirement (IEC62238)	Result	Test Engineer
Harmonic distortion and rated audio frequency output power	Sub-clause 9.1	Pass	Caspar Chen
Audio frequency response	Sub-clause 9.2	Pass	Caspar Chen
Maximum usable sensitivity	Sub-clause 9.3	Pass	Caspar Chen
Co-channel rejection	Sub-clause 9.4	Pass	Caspar Chen
Adjacent channel selectivity	Sub-clause 9.5	Pass	Caspar Chen
Spurious response rejection	Sub-clause 9.6	Pass	Caspar Chen
Intermodulation response	Sub-clause 9.7	Pass	Caspar Chen
Blocking or desensitization	Sub-clause 9.8	Pass	Caspar Chen
Spurious emissions	Sub-clause 9.9	Pass	Caspar Chen
Receiver residual noise level	Sub-clause 9.10	Pass	Caspar Chen
Squelch operation	Sub-clause 9.11	Pass	Caspar Chen
Squelch hysteresis	Sub-clause 9.12	Pass	Caspar Chen
Multiple watch characteristic	Sub-clause 9.13	Pass	Caspar Chen

Receiver for DSC decoder Requirement			
Test item	Standards requirement (IEC62238)	Result	Test Engineer
Maximum usable sensitivity	Sub-clause 10.1	Pass	Caspar Chen
Co-channel rejection	Sub-clause 10.2	Pass	Caspar Chen
Adjacent channel selectivity	Sub-clause 10.3	Pass	Caspar Chen
Spurious response and blocking immunity	Sub-clause 10.4	Pass	Caspar Chen
Intermodulation response	Sub-clause 10.5	Pass	Caspar Chen
Dynamic range	Sub-clause 10.6	Pass	Caspar Chen
Spurious emissions	Sub-clause 10.7	Pass	Caspar Chen
Verification of correct decoding of various types of DSC calls	Sub-clause 10.8	Pass	Caspar Chen
Reaction to VTS and AIS channel management DSC transmissions	Sub-clause 10.9	Pass	Caspar Chen
Simultaneous reception	Sub-clause 10.10	Pass	Caspar Chen

3. SUMMARY

3.1. Client Information

Applicant:	Shenzhen Ysair Technology Co., LTD
Address:	6/F, building 6, Yunli intelligent park, No. 3, Changfa Middle Road, Yangmei community, Bantian street, Longgang District, Shenzhen,Guangdong,China
Manufacturer:	Shenzhen Ysair Technology Co., LTD
Address:	6/F, building 6, Yunli intelligent park, No. 3, Changfa Middle Road, Yangmei community, Bantian street, Longgang District, Shenzhen,Guangdong,China

3.2. Product Description

Main unit	
Name of EUT:	VHF Marine Radio
Trade Mark:	RETEVIS
Model/Type reference:	RM20
Listed Model(s)	-
Power supply:	DC13.8V
Hardware version:	M-200BM-J150618
Software version:	V6PD7-2008-BME

RF Specification	
Support Frequency Range:	156.025~162.025MHz
Permitted frequency range:	TX:156.025MHz to 157.425MHz RX:156.050MHz to 162.025MHz
Rated Output Power:	<input checked="" type="checkbox"/> High Power: 25W <input checked="" type="checkbox"/> Low Power: 1W
Modulation Type:	Analog: FM
	Digital Data(DSC): AFSK
Channel Separation:	Analog: <input checked="" type="checkbox"/> 25kHz
	Digital Data(DSC): <input checked="" type="checkbox"/> 25kHz
Emission Designator: * ¹	Analog: 16K0F3E
	Digital Data(DSC): 16K0G2B
Antenna Type:	detachable

Note:

(1) *¹ According to FCC Part 2.202 requirements, the Necessary Bandwidth is calculated as follows:

- For FM Voice Modulation

Channel Spacing = 25 KHz, D = 5KHz max, K = 1, M = 3KHz

$B_n = 2M + 2DK = 2 \times 3 + 2 \times 5 \times 1 = 16 \text{ KHz}$

Emission designation: 16K0F3E

- Digital Data(DSC)

Channel Spacing = 25 KHz, D = 5KHz max, K = 1, M = 3KHz

$B_n = 2M + 2DK = 2 \times 3 + 2 \times 5 \times 1 = 16 \text{ KHz}$

Emission designation: 16K0G2B

3.3. Test frequency list

Modulation Type	Channel Separation	Test Channel	Test Frequency (MHz)	
			TX	RX
Analog Voice	25kHz	CH _L (CH60)	156.025	160.625
		CH _M (CH16)	156.800	156.800
		CH _H (CH88)	157.425	162.025
Digital Data(DSC)	25kHz	CH _{M1} (CH70)	156.525	156.525

3.4. EUT operation mode

Test mode	Transmitting	Receiving	Power level		Test channel	
			High	Low	CH16	CH70
TX-AWH	√		√		√	
TX-AWL	√			√	√	
TX-DSC	√		√			√
RX-AW		√			√	
RX-DSC		√				√

√ : is operation mode.

3.5. EUT configuration

The following peripheral devices and interface cables were connected during the measurement:

● - supplied by the manufacturer

○ - supplied by the lab

○	Power Cable	Length (m) :	/
		Shield :	Unshielded
		Detachable :	Undetachable
○	Multimeter	Manufacturer :	/
		Model No. :	/

4. TEST ENVIRONMENT

4.1. Address of the test laboratory

Laboratory: Shenzhen Huatongwei International Inspection Co., Ltd.

Address: 1/F, Bldg 3, Hongfa Hi-tech Industrial Park, Genyu Road, Tianliao, Gongming, Shenzhen, China

Phone: 86-755-26748019 Fax: 86-755-26748089

4.2. Test Facility

Laboratory Name	Shenzhen Huatongwei International Inspection Co., Ltd.	
Laboratory Location	1/F, Bldg 3, Hongfa Hi-tech Industrial Park, Genyu Road, Tianliao, Gongming, Shenzhen, China	
Connect information:	Tel: 86-755-26715499 E-mail: cs@szhtw.com.cn http://www.szhtw.com.cn	
Qualifications	Type	Accreditation Number
	FCC	762235

4.3. Environmental conditions

Normal Conditon	Temperature	15 °C to 35 °C		
	Relative humidity	20 % to 75 %.		
	Voltage	<input type="checkbox"/> Mains voltage	Nominal mains voltage	
<input type="checkbox"/> Lead-acid battery		1.1 * the nominal voltage of the battery		
<input checked="" type="checkbox"/> Other		the normal test voltage shall be that declared by the equipment provider		
Extreme Conditon	Temperature	<input type="checkbox"/> -15 °C and +55 °C for equipment intended for mounting below deck		
		<input checked="" type="checkbox"/> -20 °C and +55 °C for equipment intended for mounting above deck.		
		<input type="checkbox"/> -10 °C to +55 °C for Base stations for indoor/controlled climate conditions		
	Voltage	<input type="checkbox"/> Mains voltage	± 10 %* the nominal mains voltage	
		<input type="checkbox"/> Secondary battery power sources	1,3 and 0,9 multiplied by the nominal voltage of the battery	
		<input checked="" type="checkbox"/> Other	For equipment using other power sources, the extreme test voltages shall be as stated by the manufacturer.	

Normal Conditon	V _N =nominal Voltage	DC 13.8V
	T _N =normal Temperature	25 °C
Extreme Conditon	V _L =lower Voltage	DC 11.22V
	T _L =lower Temperature	-20 °C
	V _H =higher Voltage	DC 15.18V
	T _H =higher Temperature	55 °C

4.4. Statement of the measurement uncertainty

The data and results referenced in this document are true and accurate. The reader is cautioned that there may be errors within the calibration limits of the equipment and facilities. The measurement uncertainty was calculated for all measurements listed in this test report acc. to CISPR 16 - 4 „Specification for radio disturbance and immunity measuring apparatus and methods – Part 4: Uncertainty in EMC Measurements“ and is documented in the Shenzhen Huatongwei International Inspection Co., Ltd quality system acc. to DIN EN ISO/IEC 17025. Furthermore, component and process variability of devices similar to that tested may result in additional deviation. The manufacturer has the sole responsibility of continued compliance of the device.

Hereafter the best measurement capability for Shenzhen Huatongwei laboratory is reported:

Test Items	Measurement Uncertainty	Notes
Frequency stability & Occupied Bandwidth	15Hz for <1GHz 70Hz for >1GHz	(1)
Conducted Output Power	0.51dB	(1)
ERP / EIRP / RSE	2.66dB for <1GHz 3.44dB for >1GHz	(1)
Conducted Emission 9KHz-30MHz	3.02dB	(1)
Radiated Emission 30~1000MHz	4.90dB	(1)
Radiated Emission 1~18GHz	4.96dB	(1)
FM deviation	25 Hz	(1)
Audio level	0.62 dB	(1)
Low Pass Filter Response	0.76 dB	(1)
Modulation Limiting	0.42 %	(1)
Transient Frequency Behavior	6.8 %	(1)

(1) This uncertainty represents an expanded uncertainty expressed at approximately the 95% confidence level using a coverage factor of $k=1.96$.

4.5. Equipments Used during the Test

● TS8613 Test system							
Used	Test Equipment	Manufacturer	Equipment No.	Model No.	Serial No.	Last Cal. Date (YY-MM-DD)	Next Cal. Date (YY-MM-DD)
●	Spectrum Analyzer	Agilent	HTWE0286	N9020A	MY50510187	2021/09/13	2022/09/12
●	Signal & Spectrum Analyzer	R&S	HTWE0262	FSW26	103440	2021/09/13	2022/09/12
○	RF Communication Test Set	HP	HTWE0038	8920A	3813A10206	2021/09/13	2022/09/12
●	Digital intercom communication tester	Aeroflex	HTWE0255	3920B	1001682041	2021/09/13	2022/09/12
●	Signal Generator	R&S	HTWE0191	SML02	100507	2021/09/13	2022/09/12
●	Signal Generator	R&S	HTWE0337	SMC100A	107268	2021/09/13	2022/09/12
●	RF Control Unit	Tonscend	HTWE0294	JS0806-2	N/A	N/A	N/A
●	Filter-VHF	Microwave	HTWE0309	N26460M1	498702	N/A	N/A
○	Filter-UHF	Microwave	HTWE0311	N25155M2	498704	N/A	N/A
●	Power Divider	Microwave	HTWE0043	OPD1040-N-4	N/A	2022/05/16	2023/05/15
●	Attenuator	JFW	HTWE0292	50FH-030-100	N/A	2022/05/16	2023/05/15
●	Attenuator	JFW	HTWE0293	50-A-MFN-20	0322	2022/05/16	2023/05/15
●	Test software	HTW	N/A	Radio ATE	N/A	N/A	N/A

● Auxiliary Equipment							
Used	Test Equipment	Manufacturer	Equipment No.	Model No.	Serial No.	Last Cal. Date (YY-MM-DD)	Next Cal. Date (YY-MM-DD)
●	Climate chamber	ESPEC	HTWE0254	GPL-2	N/A	2021/09/14	2022/09/13
●	DC Power Supply	Gwinstek	HTWE0274	SPS-2415	GER835793	N/A	N/A

5. TEST CONDITIONS AND RESULTS

5.1. Environmental Requirement

5.1.1. Vibration test

TEST RESULTS:

Complies

Please refer to the below test data:

Frequency Error:

Operation Mode	Test conditions			Frequency Error(kHz)	Limit (KHz)	Result
	Temperature (°C)	Voltage (V)	Vibration Frequency (Hz)	CH _M		
TX-AWH	T _N	V _N	2.5~100	0.014	±1.5	Pass

Carrier power:

Operation Mode	Temperature (°C)	Voltage (V)	Vibration Frequency (Hz)	Test Channel	Measured power (dBm)	Limit (dB)	Result
TX-AWH	T _N	V _N	2.5~100	CH _M	43.95	42.47~45.47	Pass

Maximum usable sensitivity:

Operation Mode	Temperature (°C)	Voltage (V)	Vibration Frequency (Hz)	Test Channel	Measured SINAD (dB)	Limit (dB)	Result
RX-AW	T _N	V _N	2.5~100	CH _L	30.24	≥20	Pass
				CH _M	31.54		
				CH _H	30.21		

DSC receiver:

Operation Mode	Temperature (°C)	Voltage (V)	Vibration Frequency (Hz)	Test Channel	Measured (error ratio)	Limit (error ratio)	Result
RX-DSC	T _N	V _N	2.5~100	CH _{M1}	0.007	≤10 ⁻²	Pass

5.1.2. Dry heat**TEST RESULTS:**

Complies

Please refer to the below test data:

Frequency Error:

Operation Mode	Test conditions		Frequency Error(kHz)	Limit (kHz)	Result
	Temperature(°C)	Voltage (V)	CH _M		
TX-AWH	55	V _N	0.128	±1.5	Pass

Carrier power:

Operation Mode	Temperature (°C)	Voltage (V)	Test Channel	Measured power (dBm)	Limit (dB)	Result
TX-AWH	55	V _N	CH _M	43.93	42.47~45.47	Pass

Maximum usable sensitivity:

Operation Mode	Temperature (°C)	Voltage (V)	Test Channel	Measured SINAD (dB)	Limit (dB)	Result
RX-AW	55	V _N	CH _L	31.84	≥20	Pass
			CH _M	31.17		
			CH _H	30.96		

DSC receiver:

Operation Mode	Temperature (°C)	Voltage (V)	Test Channel	Measured (error ratio)	Limit (error ratio)	Result
RX-DSC	55	V _N	CH _{M1}	0.004	≤10 ⁻²	Pass

5.1.3. Damp heat**TEST RESULTS:**

Complies

Please refer to the below test data:

Frequency Error:

Operation Mode	Test conditions			Frequency Error(kHz)	Limit (kHz)	Result
	Temperature(°C)	Humidity(%)	Voltage (V)	CH _M		
TX-AWH	40	93	V _N	0.141	±1.5	Pass

Carrier power:

Operation Mode	Temperature(°C)	Humidity(%)	Voltage (V)	Test Channel	Measured power (dBm)	Limit (dB)	Result
TX-AWH	40	93	V _N	CH _M	44.26	42.47~45.47	Pass

Maximum usable sensitivity:

Operation Mode	Humidity(%)	Voltage (V)	Voltage (V)	Test Channel	Measured SINAD (dB)	Limit (dB)	Result
RX-AW	40	93	V _N	CH _L	31.27	≥20	Pass
				CH _M	30.69		
				CH _H	31.21		

DSC receiver:

Operation Mode	Temperature(°C)	Humidity(%)	Voltage (V)	Test Channel	Measured (error ratio)	Limit (error ratio)	Result
RX-DSC	40	93	V _N	CH _{M1}	0.004	≤10 ⁻²	Pass

5.1.4. Low temperature**TEST RESULTS:**

Complies

Please refer to the below test data:

Frequency Error:

Operation Mode	Test conditions		Frequency Error(kHz)	Limit (kHz)	Result
	Temperature(°C)	Voltage (V)	CH _M		
TX-AWH	-15	V _N	0.169	±1.5	Pass

Carrier power:

Operation Mode	Temperature (°C)	Voltage (V)	Test Channel	Measured power (dBm)	Limit (dB)	Result
TX-AWH	-15	V _N	CH _M	44.27	42.47~45.47	Pass

Maximum usable sensitivity:

Operation Mode	Temperature (°C)	Voltage (V)	Test Channel	Measured SINAD (dB)	Limit (dB)	Result
RX-AW	-15	V _N	CH _L	31.24	≥20	Pass
			CH _M	33.25		
			CH _H	32.48		

DSC receiver:

Operation Mode	Temperature (°C)	Voltage (V)	Test Channel	Measured (error ratio)	Limit (error ratio)
RX-DSC	-15	V _N	CH _{M1}	0.009	≤10 ⁻²

5.2. Transmitter Requirement

5.2.1. Frequency error

The frequency error is the difference between the measured carrier frequency and its nominal value.

LIMIT

IEC 62238 Sub-clause 8.1.3

The frequency error shall be within $\pm 1,5$ kHz.

TEST CONFIGURATION

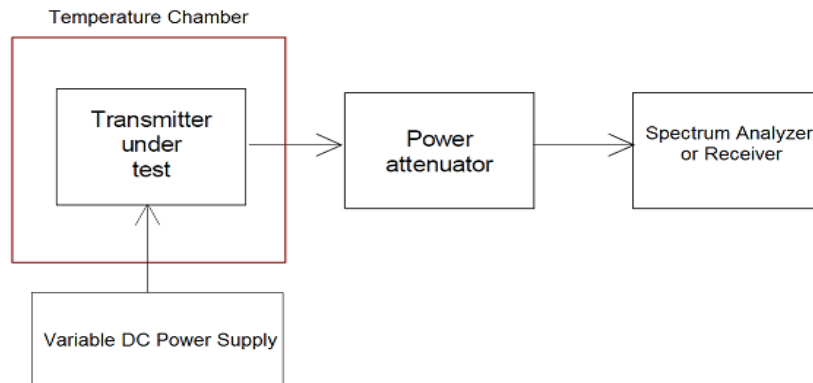

TEST PROCEDURE

1. The test conditions.

normal condition Extreme conditions

2. Please refer to IEC 62238 Sub-clause 8.1.2 for the measurement method.

TEST MODE:

Please reference to the section 3.4

TEST RESULTS

Passed Not Applicable

Please refer to appendix A on the section 8 appendix report

5.2.2. Carrier Power (Conducted)

The carrier power is the mean power delivered to the artificial antenna during one radio frequency cycle in the absence of modulation. The rated output power is the carrier power declared by the manufacturer.

LIMIT

IEC 62238 Sub-clause 8.2.3

Normal test conditions:

The rated output power of the equipment shall be between 6 W and 25 W.

With the output power switch set at maximum, the carrier power shall be within $\pm 1,5$ dB of the rated output power under normal test conditions. The output power shall never however exceed 25 W.

With the output power switch set at minimum the carrier power shall remain between 0,1 W and 1 W.

The maximum continuous transmission time shall be between 5 min and 6 min.

Extreme test conditions:

With the output power switch set at maximum, the carrier power shall remain between 6 W and 25 W and be within +2 dB, -3 dB of the rated output power under extreme conditions. The output power shall never however exceed 25 W.

With the output power switch set at minimum the carrier power shall remain between 0,1 W and 1 W.

The maximum continuous transmission time shall be between 5 min and 6 min.

TEST CONFIGURATION

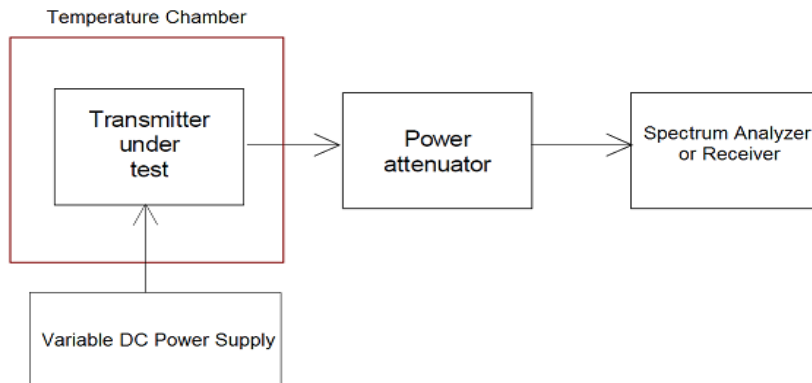

TEST PROCEDURE

1. The test conditions.

normal condition

Extreme conditions

2. Please refer to IEC 62238 Sub-clause 8.2.2 for the measurement method.

TEST MODE:

Please reference to the section 3.4

TEST RESULTS

Passed

Not Applicable

Please refer to appendix B on the section 8 appendix report

5.2.3. Frequency Deviation

For the purpose of the present document, the frequency deviation is the difference between the instantaneous frequency of the modulated radio frequency signal and the carrier frequency.

LIMIT

IEC 62238 Sub-clause 8.3.3

The maximum permissible frequency deviation shall be:

25 kHz channels: ± 5 kHz.

12,5 kHz channels: $\pm 2,5$ kHz.

between 3,0 kHz/2,55 kHz and 6,0 kHz: shall not exceed the frequency deviation at a modulation frequency of 3,0 kHz/2,55 kHz.

At 6,0 kHz the deviation shall be not more than 30,0 % of the maximum permissible frequency deviation.

between 6,0 kHz and a frequency equal to the channel separation for which the equipment is intended shall not exceed that given by a linear representation of the frequency deviation (dB) relative to the modulation frequency, starting at the 6,0 kHz limit and having a slope of -14,0 dB per octave.

These limits are illustrated in figure 1.

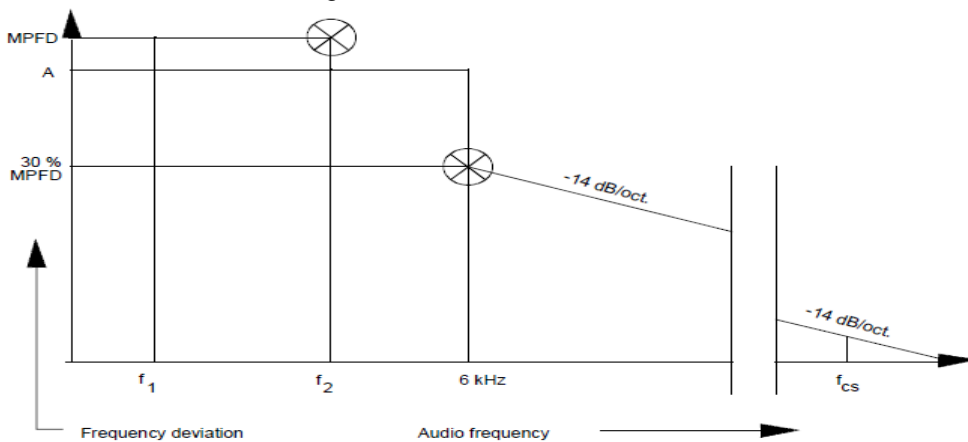

NOTE:
 Abbreviations:
 f_1 lowest appropriate frequency
 f_2 3,0 kHz (for 25 kHz channel separation), or
 2,55 kHz (for 12,5 kHz channel separation)
 MPFD Maximum Permissible Frequency Deviation, clause 8.3.2.1
 A measured frequency deviation at f_2
 f_{cs} frequency equal to channel separation

Figure 1: Frequency deviation

TEST PROCEDURE

1. The test conditions.

normal condition Extreme conditions

2. Please refer to IEC 62238 Sub-clause 8.3.2 for the measurement method.

TEST CONFIGURATION

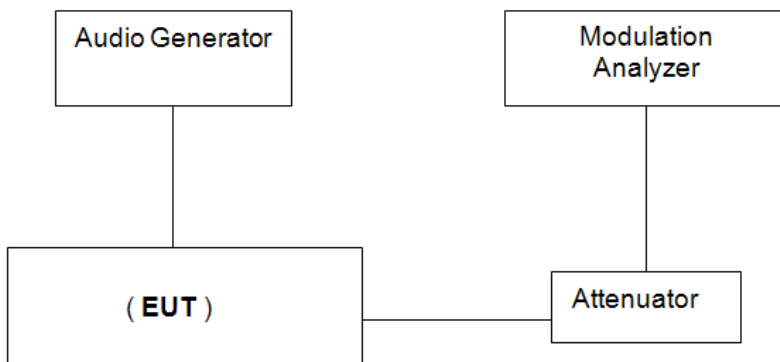

TEST MODE:

Please reference to the section 3.4

TEST RESULTS

Passed **Not Applicable**

Please refer to appendix C on the section 8 appendix report

5.2.4. Sensitivity of the modulator, including microphone

This characteristic expresses the capability of the transmitter to produce sufficient modulation when an audio frequency signal corresponding to the normal mean speech level is applied to the microphone.

LIMIT

IEC 62238 Sub-clause 8.4.3

The resulting frequency deviation shall be between $\pm 1,5$ kHz and ± 3 kHz.

TEST PROCEDURE

1. The test conditions.
 normal condition Extreme conditions
2. Please refer to IEC 62238 Sub-clause 8.4.2 for the measurement method.

TEST CONFIGURATION

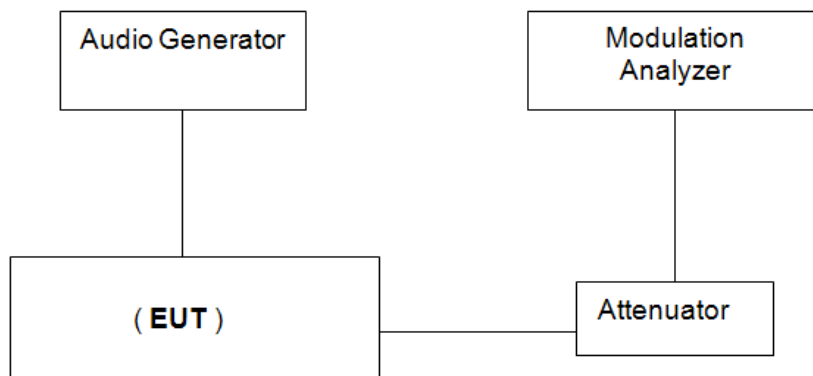

TEST MODE:

Please reference to the section 3.4

TEST RESULTS

Passed Not Applicable

Please refer to appendix D on the section 8 appendix report

5.2.5. Audio frequency response

The audio frequency response is the frequency deviation of the transmitter as a function of the modulating frequency.

LIMIT

IEC 62238 Sub-clause 8.5.3

The audio frequency response shall be within +1 dB and -3 dB of a 6 dB/octave line passing through the reference point (see figure 2). The upper limit frequency shall be 2,55 kHz for 12,5 kHz channels.

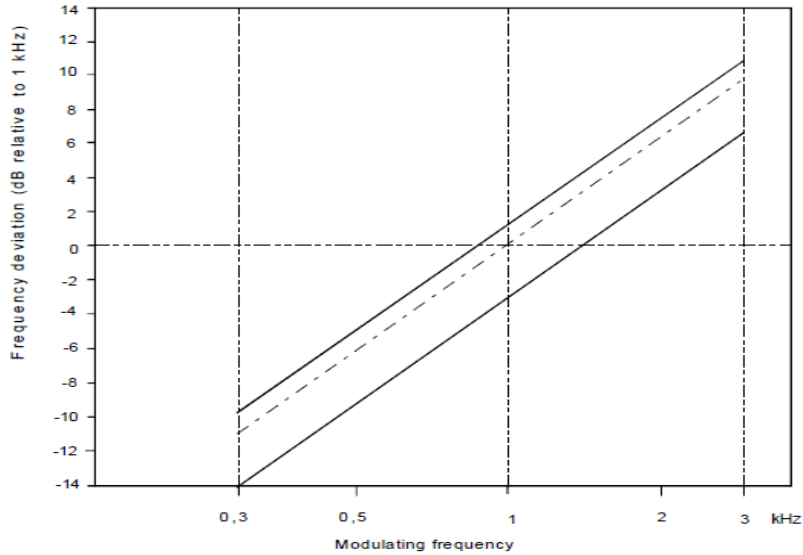
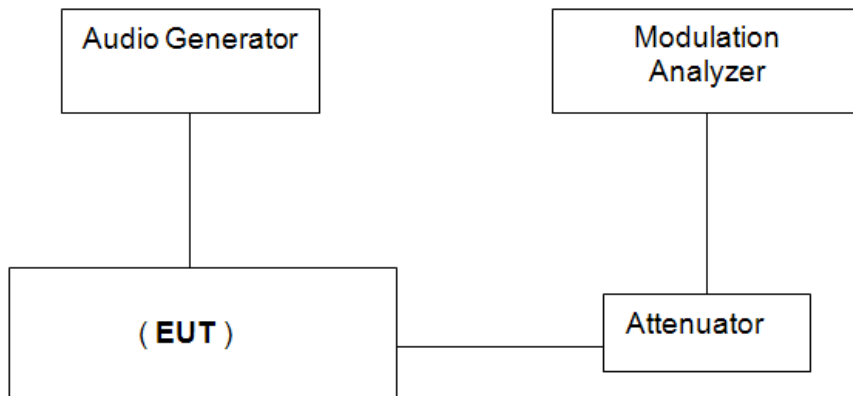

Figure 2: Audio frequency response

TEST CONFIGURATION



TEST PROCEDURE

1. The test conditions.

normal condition Extreme conditions

2. Please refer to IEC 62238 Sub-clause 8.5.2 for the measurement method.

TEST MODE:

Please reference to the section 3.4

TEST RESULTS

Passed Not Applicable

Please refer to appendix E on the section 8 appendix report

5.2.6. Audio frequency harmonic distortion of the emission

The harmonic distortion of the emission modulated by an audio frequency signal is defined as the ratio, expressed as a percentage, of the root mean square (rms) voltage of all the harmonic components of the fundamental modulation frequency to the total rms voltage of the modulation signal after linear demodulation

LIMIT

IEC 62238 Sub-clause 8.6.3

The harmonic distortion shall not exceed 10 %.

TEST CONFIGURATION

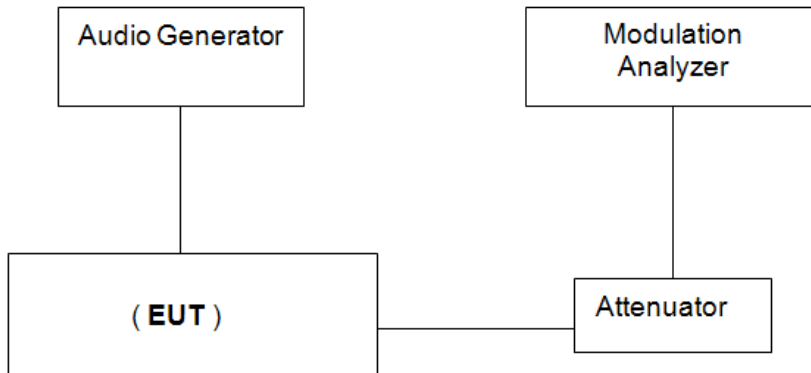

TEST PROCEDURE

1. The test conditions.

normal condition

Extreme conditions

2. Please refer to IEC 62238 Sub-clause 8.6.2 for the measurement method.

TEST MODE:

Please reference to the section 3.4

TEST RESULTS

Passed

Not Applicable

Please refer to appendix F on the section 8 appendix report

5.2.7. Adjacent Channel Power

The adjacent channel power is that part of the total power output of a transmitter under defined conditions of modulation, which falls within a specified passband centred on the nominal frequency of either of the adjacent channels. This power is the sum of the mean power produced by the modulation, hum and noise of the transmitter.

LIMIT

IEC 62238 Sub-clause 8.7.3

The adjacent channel power shall not exceed a value of:

25 kHz channel: 70 dB below the carrier power of the transmitter without any need to be below 0,2 μ W.

12 kHz channel: 60 dB below the carrier power of the transmitter without any need to be below 0,2 μ W.

TEST CONFIGURATION

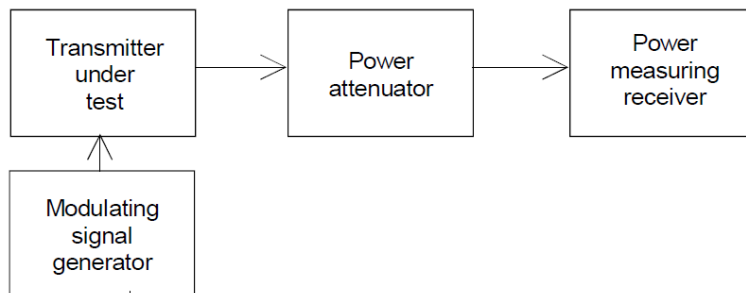

TEST PROCEDURE

1. The test conditions.

normal condition Extreme conditions

2. Please refer to IEC 62238 Sub-clause 8.7.2 for the measurement method.

TEST MODE:

Please reference to the section 3.4

TEST RESULTS

Passed **Not Applicable**

Please refer to appendix G on the section 8 appendix report

5.2.8. Conducted spurious emissions conveyed to the antenna

Conducted spurious emissions are emissions on a frequency or frequencies which are outside the necessary bandwidth and the level of which may be reduced without affecting the corresponding transmission of information. Spurious emissions include harmonic emissions, parasitic emissions, intermodulation products and frequency conversion products, but exclude out of band emissions.

LIMIT

IEC 62238 Sub-clause 8.8.3

The power of any conducted spurious emission on any discrete frequency shall not exceed 0,25 μ W(-36dBm).

TEST CONFIGURATION

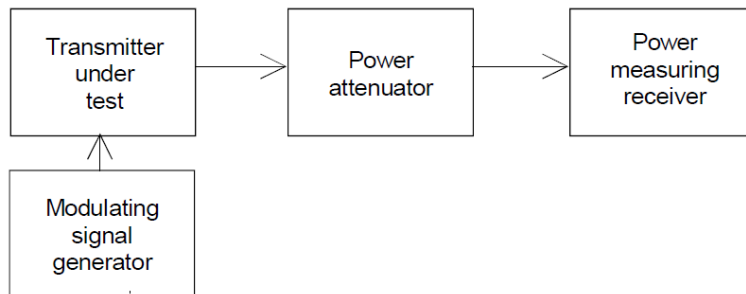

TEST PROCEDURE

1. The test conditions.

normal condition Extreme conditions

2. Please refer to IEC 62238 Sub-clause 8.8.2 for the measurement method.

TEST MODE:

Please reference to the section 3.4

TEST RESULTS

Passed **Not Applicable**

Please refer to appendix H on the section 8 appendix report

5.2.9. Transient frequency behaviour of the transmitter

The residual modulation of the transmitter is the ratio, in decibels, of the demodulated radiofrequency signal in the absence of wanted modulation, to the modulated radiofrequency signal produced when the normal test modulation is applied.

LIMIT

IEC 62238 Sub-clause 8.9.3

During the period of time t_1 and t_3 the frequency difference shall not exceed the value of one channel separation. The frequency difference, after the end of t_2 , shall be within the limit of the frequency error of $\pm 1,5$ kHz.

During the period of time t_2 the frequency difference shall not exceed the value of half a channel separation. Before the start of t_3 the frequency difference shall be within the limit of the frequency error of $\pm 1,5$ kHz.

TEST CONFIGURATION

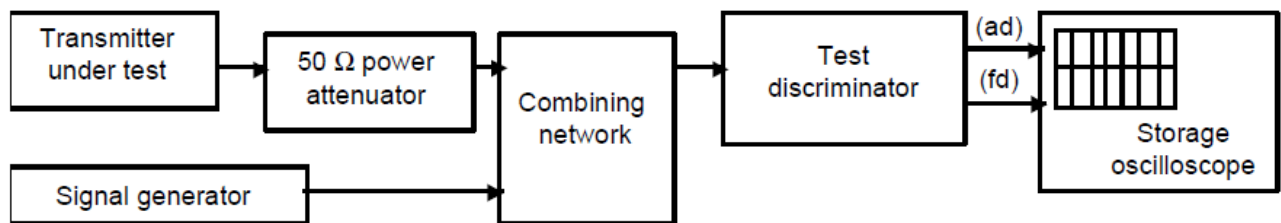

TEST PROCEDURE

1. The test conditions.

normal condition Extreme conditions

2. Please refer to IEC 62238 Sub-clause 8.9.2 for the measurement method.

TEST MODE:

Please reference to the section 3.4

TEST RESULTS

Passed Not Applicable

Please refer to appendix I on the section 8 appendix report

5.2.10. Residual modulation of the transmitter

The residual modulation of the transmitter is the ratio, in dB, of the demodulated RF signal in the absence of wanted modulation, to the demodulated RF signal produced when the normal test modulation is applied.

LIMIT

IEC 62238 Sub-clause 8.10.3

The residual modulation shall not exceed -40 dB on either 25 kHz or 12,5 kHz channels.

TEST CONFIGURATION

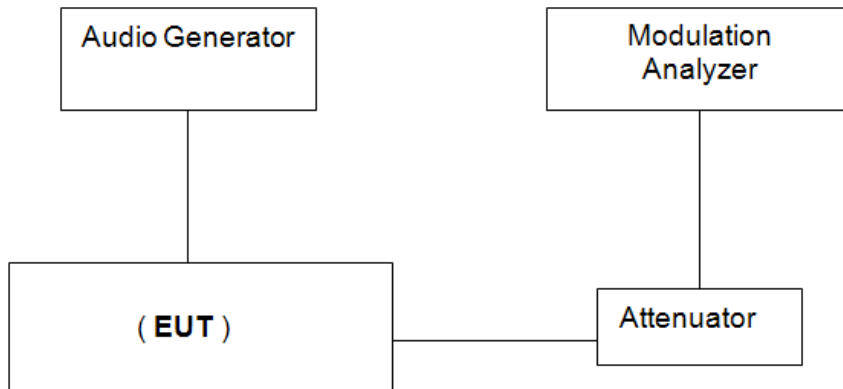

TEST PROCEDURE

1. The test conditions.

normal condition

Extreme conditions

2. Please refer to IEC 62238 Sub-clause 8.10.2 for the measurement method.

TEST MODE:

Please reference to the section 3.4

TEST RESULTS

Passed

Not Applicable

Please refer to appendix J on the section 8 appendix report

5.2.11. Frequency error (demodulated DSC signal)

The frequency error for the B- and the Y-state is the difference between the measured frequency from the demodulator and the nominal values.

LIMIT

IEC 62238 Sub-clause 8.11.3

The measured frequency from the demodulator at any time for the B-state shall be within 2 100 Hz \pm 10 Hz and for the Y-state within 1 300 Hz \pm 10 Hz.

TEST CONFIGURATION

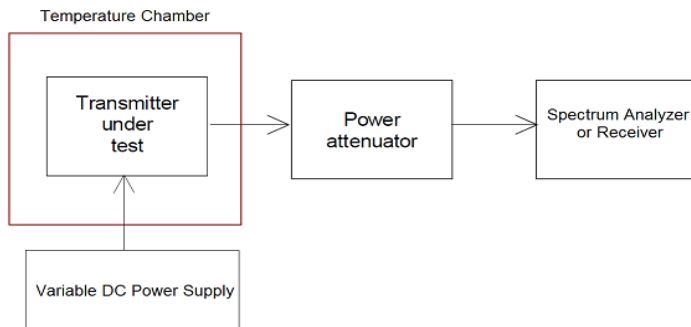

TEST PROCEDURE

1. The test conditions.

normal condition

Extreme conditions

2. Please refer to IEC 62238 Sub-clause 8.11.2 for the measurement method.

TEST MODE:

Please reference to the section 3.4

TEST RESULTS

Passed

Not Applicable

Please refer to appendix K on the section 8 appendix report

5.2.12. Modulation index for DSC

This test measures the modulation index in the B and Y states.

LIMIT

IEC 62238 Sub-clause 8.12.3

The modulation index shall be $2,0 \pm 10 \%$.

TEST CONFIGURATION

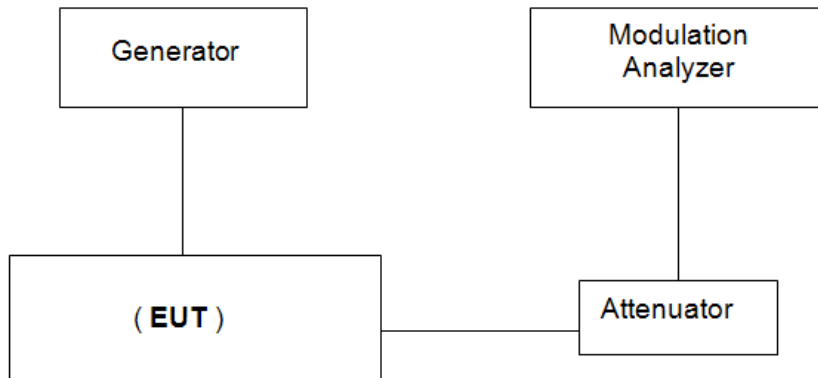

TEST PROCEDURE

1. The test conditions.

normal condition Extreme conditions

2. Please refer to IEC 62238 Sub-clause 8.12.2 for the measurement method.

TEST MODE:

Please reference to the section 3.4

TEST RESULTS

Passed Not Applicable

Please refer to appendix L on the section 8 appendix report

5.2.13. Modulation rate for DSC

The modulation rate is the bit stream speed measured in bit/s.

LIMIT

IEC 62238 Sub-clause 8.13.3

The frequency shall be 600 Hz \pm 30 ppm corresponding to a modulation rate of 1 200 baud.

TEST CONFIGURATION

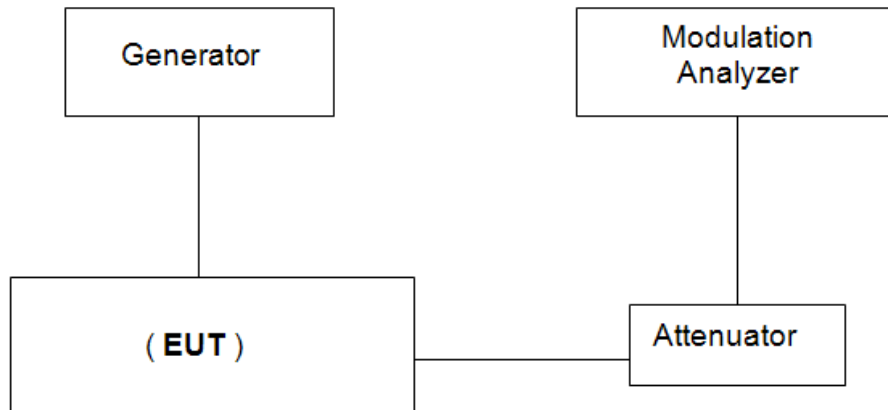

TEST PROCEDURE

1. The test conditions.

normal condition Extreme conditions

2. Please refer to IEC 62238 Sub-clause 8.13.2 for the measurement method.

TEST MODE:

Please reference to the section 3.4

TEST RESULTS

Passed Not Applicable

Please refer to appendix M on the section 8 appendix report

5.2.14. Testing of generated call sequences

Generated call sequences are call which comply with the requirements of ITU-R. Recommendation M.493-10.

Requirement

IEC 62238 Sub-clause 8.14.3

The requirements of ITU-R Recommendation M.493-14 regarding message composition and content shall be met.

The generated calls shall be analyzed with the calibrated apparatus for correct configuration of the signal format, including time diversity. It shall be verified that, after transmission of a DSC call, the transmitter re-tunes to the original channel. However, in the case of a distress call, the transmitter shall tune to channel 16 and automatically select the maximum power. The telecommands used and the channels tested for switching shall be stated in the test report.

TEST RESULTS

Passed **Not Applicable**

Please refer to appendix N on the section 8 appendix report

5.3. Receiver for Radiotelephone Requirement

5.3.1. Harmonic distortion and rated audio frequency output power

The harmonic distortion at the receiver output is defined as the ratio, expressed as a percentage, of the total rms voltage of all the harmonic components of the modulation audio frequency to the total rms voltage of the signal delivered by the receiver.

The rated audio frequency output power is the value stated by the manufacturer to be the maximum power available at the output, for which all the requirements of the present document are met.

LIMIT

IEC 62238 Sub-clause 9.1.3

- 2 W in a loudspeaker;
- 1 mW in the handset earphone.

The harmonic distortion shall not exceed 10 %.

TEST CONFIGURATION

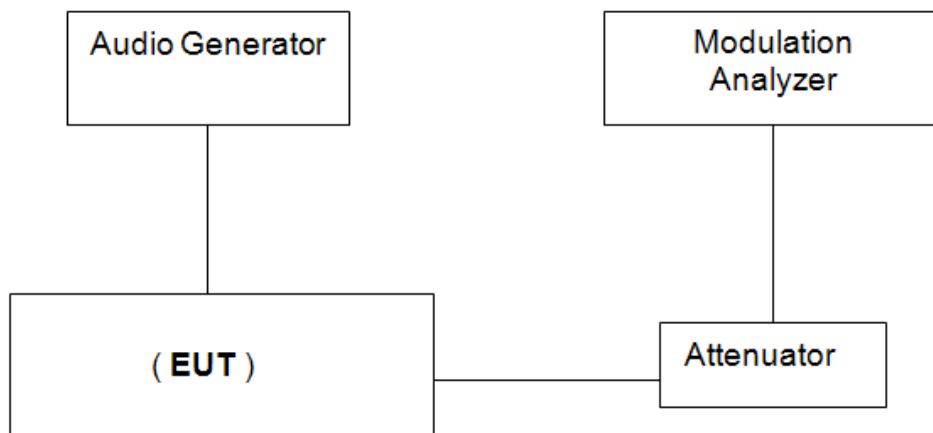

TEST PROCEDURE

1. The test conditions.

- normal condition Extreme conditions

2. Please refer to IEC 62238 Sub-clause 9.1.2 for the measurement method.

TEST MODE:

Please reference to the section 3.4

TEST RESULTS

- Passed Not Applicable

Please refer to appendix O on the section 8 appendix report

5.3.2. Audio frequency response

The audio frequency response is the variation in the receiver's audio frequency output level as a function of the modulating frequency of a received radio frequency signal modulated with constant deviation.

LIMIT

IEC 62238 Sub-clause 9.2.3

The audio frequency response shall not deviate by more than +1 dB or -3 dB from a characteristic giving the output level as a function of the audio frequency, decreasing by 6 dB per octave and passing through the measured point at 1 kHz (figure 5).

Certified Intrinsically Safe equipment need not comply with the limits below 700 Hz.

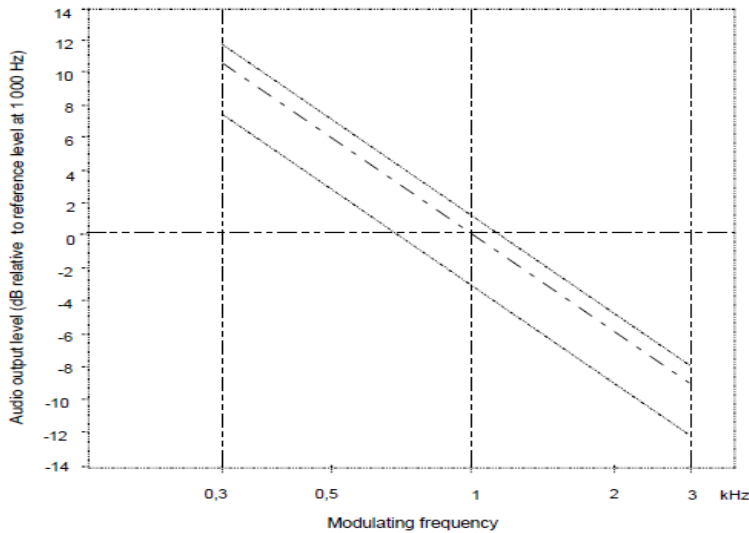
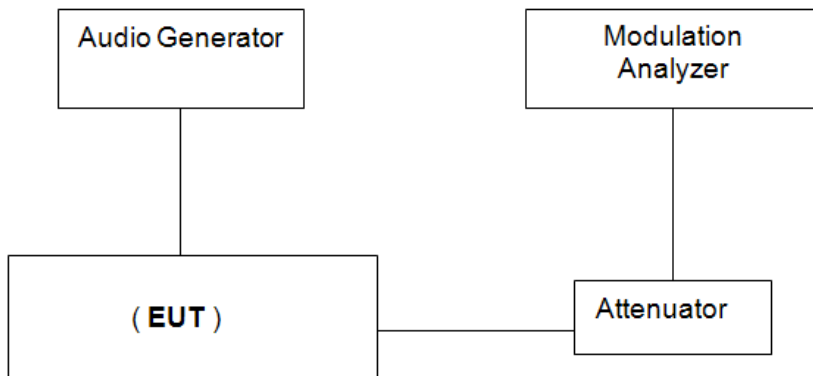

Figure 5: Audio frequency response

TEST CONFIGURATION



TEST PROCEDURE

1. The test conditions.

- normal condition Extreme conditions

2. Please refer to IEC 62238 Sub-clause 9.2.2 for the measurement method.

TEST MODE:

Please reference to the section 3.4

TEST RESULTS

- Passed Not Applicable

Please refer to appendix P on the section 8 appendix report

5.3.3. Maximum Usable Sensitivity

The maximum usable sensitivity of the receiver is the minimum level of the signal (emf) at the nominal frequency of the receiver which, when applied to the receiver input with normal test modulation (clause 6.4), will produce:

- in all cases, an audio frequency output power of at least 50 % of the rated output power (clause 9.1); and
- a SINAD ratio of 20 dB, measured at the receiver output through a psophometric telephone filtering network such as described in ITU-T Recommendation O.41 [6].

LIMIT

IEC 62238 Sub-clause 9.3.3

The maximum usable sensitivity for either 25 kHz or 12,5 kHz channels shall not exceed +6 dB μ V (emf) under normal test conditions and +12 dB μ V (emf) under extreme test conditions.

TEST CONFIGURATION

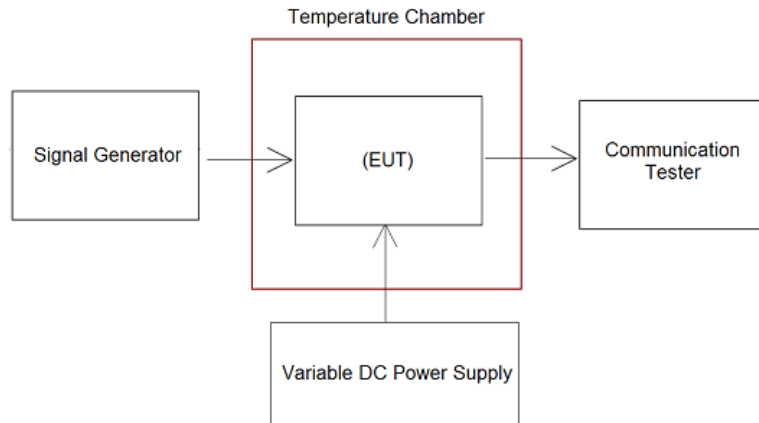

TEST PROCEDURE

1. The test conditions.

- normal condition Extreme conditions

2. Please refer to IEC 62238 Sub-clause 9.3.2 for the measurement method.

TEST MODE:

Please reference to the section 3.4

TEST RESULTS

- Passed Not Applicable

Please refer to appendix Q on the section 8 appendix report

5.3.4. Co-channel rejection

The co-channel rejection is a measure of the capability of the receiver to receive a wanted modulated signal without exceeding a given degradation due to the presence of an unwanted modulated signal, both signals being at the nominal frequency of the receiver.

LIMIT

IEC 62238 Sub-clause 9.4.3

The co-channel rejection ratio, at any frequency of the unwanted signal within the specified range, shall be between: -10 dB and 0 dB.

TEST CONFIGURATION

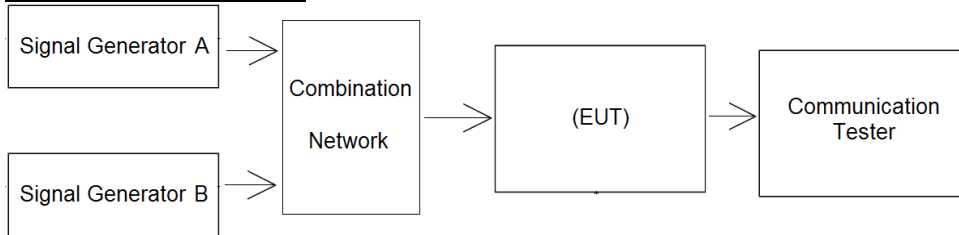

TEST PROCEDURE

1. The test conditions.

normal condition Extreme conditions

2. Please refer to IEC 62238 Sub-clause 9.4.2 for the measurement method.

TEST MODE:

Please reference to the section 3.4

TEST RESULTS

Passed **Not Applicable**

Please refer to appendix R on the section 8 appendix report

5.3.5. Adjacent channel selectivity

The adjacent channel selectivity is a measure of the capability of the receiver to receive a wanted modulated signal without exceeding a given degradation due to the presence of an unwanted modulated signal which differs in frequency from the wanted signal by the nominal channel spacing.

LIMIT

IEC 62238 Sub-clause 9.5.3

The adjacent channel selectivity shall be not less than 70 dB under normal test conditions and not less than 60 dB under extreme test conditions.

TEST CONFIGURATION

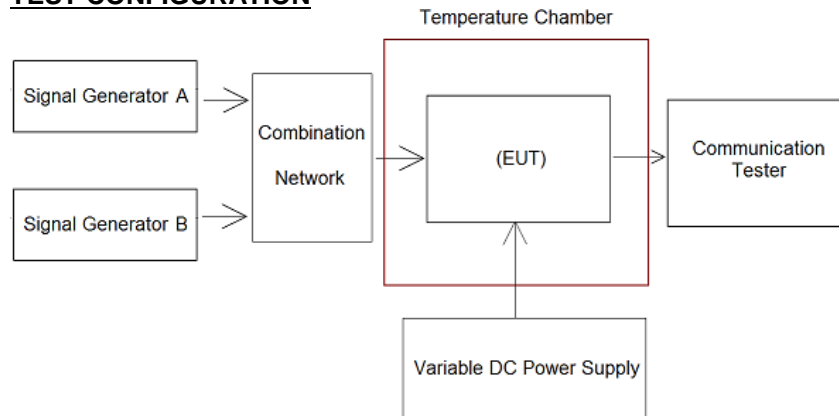

TEST PROCEDURE

1. The test conditions.

normal condition Extreme conditions

2. Please refer to IEC 62238 Sub-clause 9.5.2 for the measurement method.

TEST MODE:

Please reference to the section 3.4

TEST RESULTS

Passed Not Applicable

Please refer to appendix S on the section 8 appendix report

5.3.6. Spurious Response Rejection

The spurious response rejection is a measure of the capability of the receiver to discriminate between the wanted modulated signal at the nominal frequency and an unwanted signal at any other frequency at which a response is obtained.

LIMIT

IEC 62238 Sub-clause 9.6.3

At any frequency separated from the nominal frequency of the receiver by more than 25 kHz, the spurious response rejection ratio shall be not less than 70 dB.

TEST CONFIGURATION

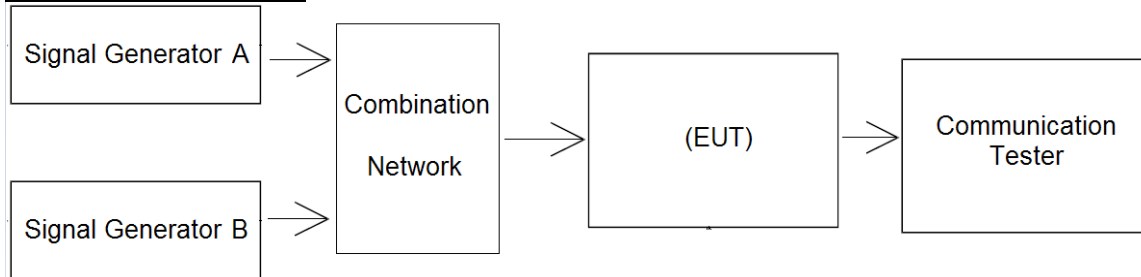

TEST PROCEDURE

1. The test conditions.

normal condition

Extreme conditions

2. Please refer to IEC 62238 Sub-clause 9.6.2 for the measurement method.

TEST MODE:

Please reference to the section 3.4

TEST RESULTS

Passed

Not Applicable

Please refer to appendix T on the section 8 appendix report

5.3.7. Intermodulation response

The intermodulation response is a measure of the capability of a receiver to receive a wanted modulated signal without exceeding a given degradation due to the presence of two or more unwanted signals with a specific frequency relationship to the wanted signal frequency.

LIMIT

IEC 62238 Sub-clause 9.7.3

The intermodulation response ratio shall not be less than 68 dB.

TEST CONFIGURATION

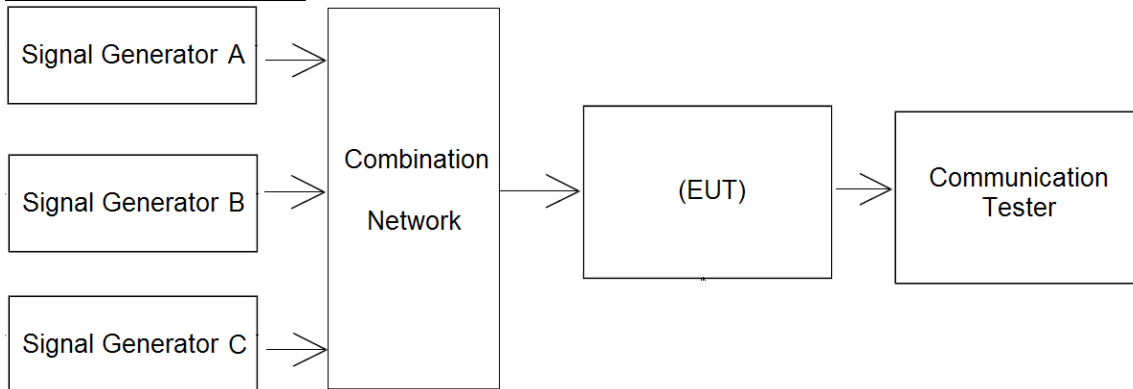

TEST PROCEDURE

1. The test conditions.

normal condition Extreme conditions

2. Please refer to IEC 62238 Sub-clause 9.7.2 for the measurement method.

TEST MODE:

Please reference to the section 3.4

TEST RESULTS

Passed Not Applicable

Please refer to appendix U on the section 8 appendix report

5.3.8. Blocking or Desensitization

Blocking is a change (generally a reduction) in the wanted output power of the receiver or a reduction of the SINAD ratio due to an unwanted signal on another frequency.

LIMIT

IEC 62238 Sub-clause 9.8.3

The blocking level for any frequency within the specified ranges, shall be not less than 90 dB μ V (emf), except at frequencies on which spurious responses are found

TEST CONFIGURATION

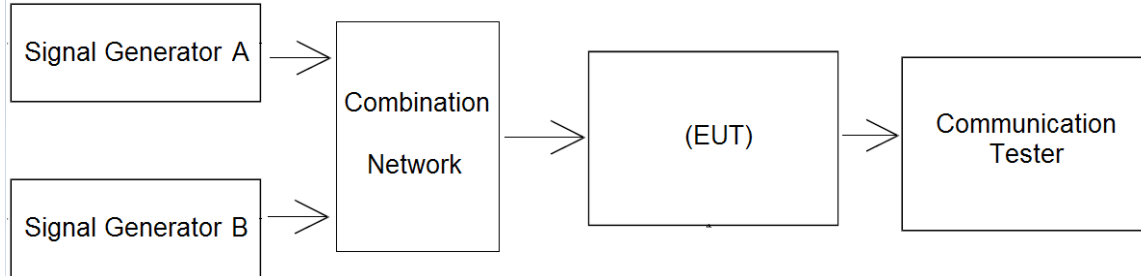

TEST PROCEDURE

1. The test conditions.

normal condition Extreme conditions

2. Please refer to IEC 62238 Sub-clause 9.8.2 for the measurement method.

TEST MODE:

Please reference to the section 3.4

TEST RESULTS

Passed Not Applicable

Please refer to appendix V on the section 8 appendix report

5.3.9. Conducted spurious emissions

Conducted spurious emissions from the receiver are components at any frequency, present at the receiver input port.

LIMIT

IEC 62238 Sub-clause 9.9.3

The power of any spurious radiation shall not exceed 2 nw(-57dBm) at any frequency in the range between 9 kHz and 2 GHz.

TEST CONFIGURATION

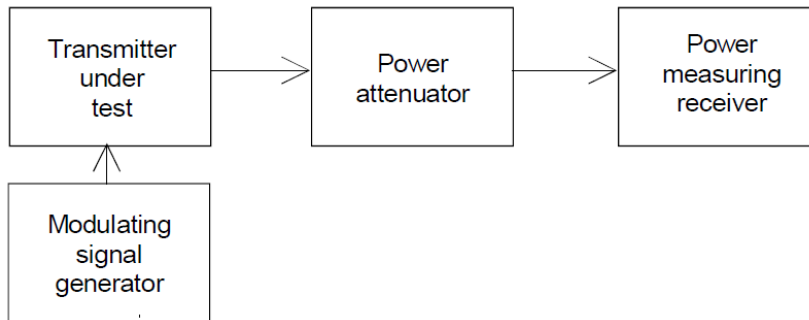

TEST PROCEDURE

1. The test conditions.

normal condition

Extreme conditions

2. Please refer to IEC 62238 Sub-clause 9.9.2 for the measurement method.

TEST MODE:

Please reference to the section 3.4

TEST RESULTS

Passed

Not Applicable

Please refer to appendix W on the section 8 appendix report

5.3.10. Receiver noise and hum level

The receiver noise and hum level is defined as the ratio, in dB, of the audio frequency power of the noise and hum resulting from spurious effects of the power supply system or from other causes, to the audio frequency power produced by a high frequency signal of average level, modulated by the normal test modulation and applied to the receiver input.

LIMIT

IEC 62238 Sub-clause 9.10.3

The receiver noise and hum level shall not exceed -40 dB, relative to the modulated signal.

TEST CONFIGURATION

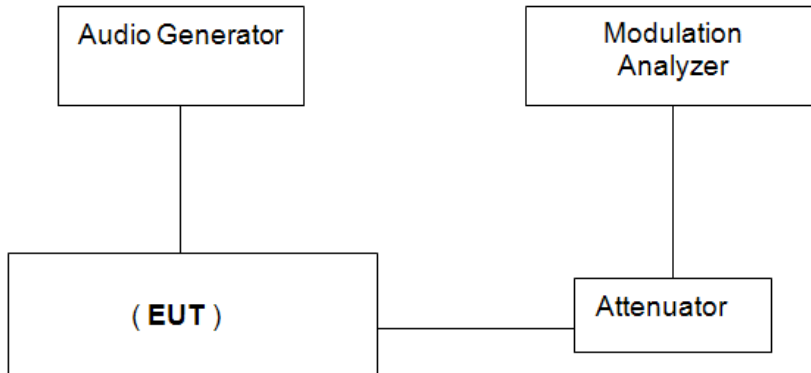

TEST PROCEDURE

1. The test conditions.

normal condition

Extreme conditions

2. Please refer to IEC 62238 Sub-clause 9.10.2 for the measurement method.

TEST MODE:

Please reference to the section 3.4

TEST RESULTS

Passed

Not Applicable

Please refer to appendix X on the section 8 appendix report

5.3.11. Squelch operation

The purpose of the squelch facility is to mute the receiver audio output signal when the level of the signal at the receiver input is less than a given value.

LIMIT

IEC 62238 Sub-clause 9.11.3

Under the conditions specified in a) clause 9.11.2, the audio frequency output power shall not exceed -40 dB relative to the rated output power.

Under the conditions specified in b) clause 9.11.2, the input level shall not exceed +6 dB μ V (emf) and the SINAD ratio shall be at least 20 dB.

Under the conditions specified in c) clause 9.11.2, the input signal shall not exceed +6 dB μ V (emf) when the control is set at maximum.

TEST CONFIGURATION

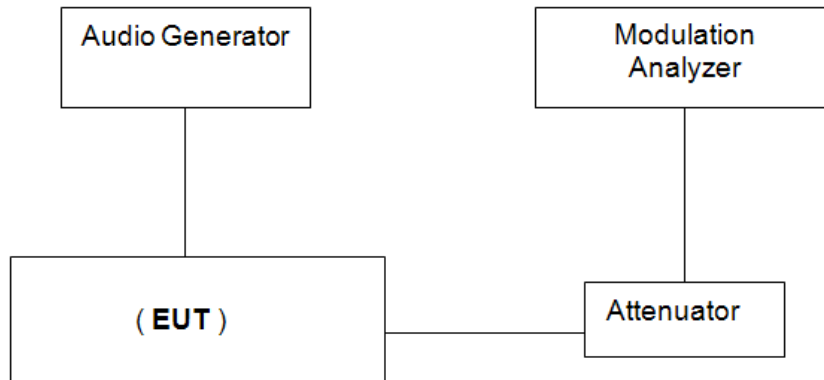

TEST PROCEDURE

- The test conditions.
 - normal condition
 - Extreme conditions
- Please refer to IEC 62238 Sub-clause 9.11.2 for the measurement method.

TEST MODE:

Please reference to the section 3.4

TEST RESULTS

Passed Not Applicable

Please refer to appendix Y on the section 8 appendix report

5.3.12. Squelch hysteresis

Squelch hysteresis is the difference in dB between the receiver input signal levels at which the squelch opens and closes.

LIMIT

IEC 62238 Sub-clause 9.12.3

The squelch hysteresis shall be between 3 dB and 6 dB.

TEST CONFIGURATION

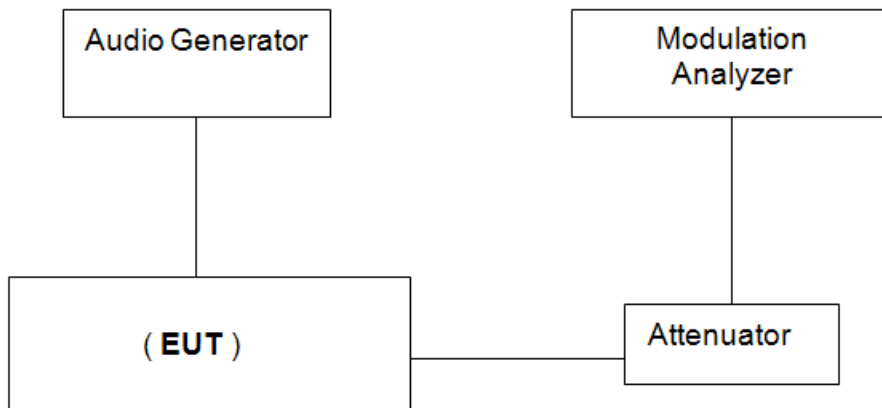

TEST PROCEDURE

1. The test conditions.

normal condition

Extreme conditions

2. Please refer to IEC 62238 Sub-clause 9.12.2 for the measurement method.

TEST MODE:

Please reference to the section 3.4

TEST RESULTS

Passed

Not Applicable

Please refer to appendix Z on the section 8 appendix report

5.3.13. Multiple watch characteristic

The scanning period is the time between the start of two successive samples of the priority channel in the absence of a signal on that channel.

LIMIT

IEC 62238 Sub-clause 9.13.3

The scanning period shall not exceed 2 s.

The dwell time on the priority channel shall not exceed 150 ms.

The dwell time on the additional channel shall be between 850 ms and 2 s as indicated by the time of the gap between two output bursts.

TEST CONFIGURATION

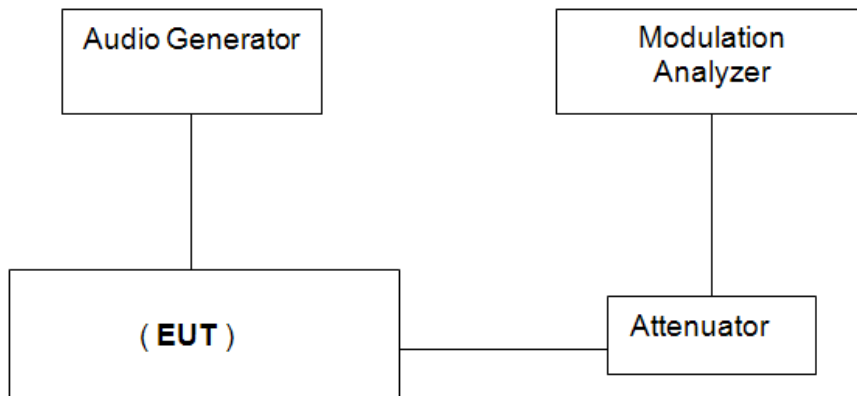

TEST PROCEDURE

1. The test conditions.

normal condition

Extreme conditions

2. Please refer to IEC 62238 Sub-clause 9.13.2 for the measurement method.

TEST MODE:

Please reference to the section 3.4

TEST RESULTS

Passed

Not Applicable

Please refer to appendix AA on the section 8 appendix report

5.4. Receiver for DSC decoder Requirement

5.4.1. Maximum usable sensitivity

The maximum usable sensitivity of the receiver is the minimum level of the signal (e.m.f.) at the nominal frequency of the receiver which when applied to the receiver input with a test modulation will produce a bit error ratio of 10^{-2}

LIMIT

IEC 62238 Sub-clause 10.1.3

The bit error ratio shall be equal to or less than 10^{-2}

TEST CONFIGURATION

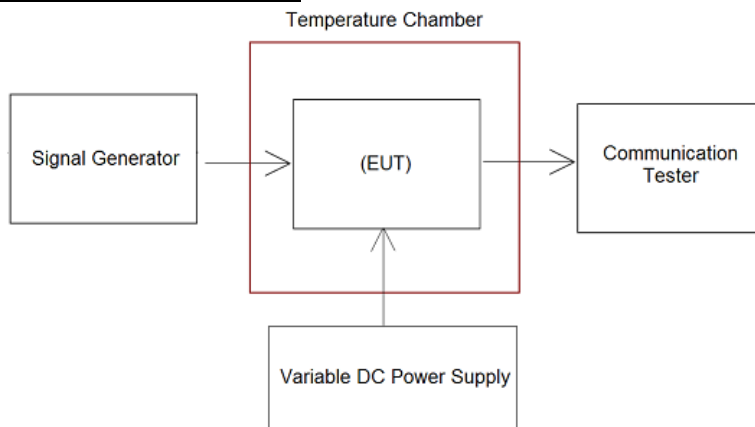

TEST PROCEDURE

1. The test conditions.

normal condition Extreme conditions

2. Please refer to IEC 62238 Sub-clause 10.1.2 for the measurement method.

TEST MODE:

Please reference to the section 3.4

TEST RESULTS

Passed Not Applicable

Please refer to appendix AB on the section 8 appendix report

5.4.2. Co-channel rejection

The co-channel rejection is a measure of the capability of the receiver to receive a wanted modulated signal without exceeding a given degradation due to the presence of an unwanted modulated signal, both signals being at the nominal frequency of the receiver.

LIMIT

IEC 62238 Sub-clause 10.2.3

The bit error ratio shall be equal to or less than 10^{-2} .

TEST CONFIGURATION

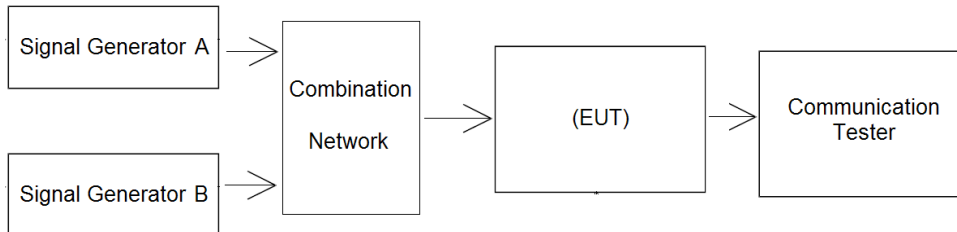

TEST PROCEDURE

1. The test conditions.

normal condition Extreme conditions

2. Please refer to IEC 62238 Sub-clause 10.2.2 for the measurement method.

TEST MODE:

Please reference to the section 3.4

TEST RESULTS

Passed Not Applicable

Please refer to appendix AC on the section 8 appendix report

5.4.3. Adjacent channel selectivity

The adjacent channel selectivity is a measure of the capability of the receiver to receive a wanted modulated signal without exceeding a given degradation due to the presence of an unwanted modulated signal which differs in frequency from the wanted signal by 25 kHz.

LIMIT

IEC 62238 Sub-clause 10.3.3

The bit error ratio shall be equal to or less than 10^{-2}

TEST CONFIGURATION

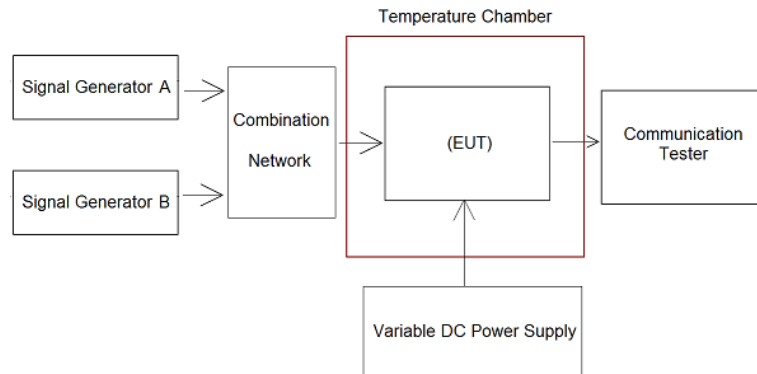

TEST PROCEDURE

- The test conditions.
 - normal condition
 - Extreme conditions
- Please refer to IEC61138 Sub-clause 10.3.2 for the measurement method.

TEST MODE:

Please reference to the section 3.4

TEST RESULTS

Passed Not Applicable

Please refer to appendix AD on the section 8 appendix report

5.4.4. Spurious response and blocking immunity

The spurious response and blocking immunity is a measure of the capability of the receiver to receive a wanted modulated signal without exceeding a given degradation due to the presence of an unwanted modulated signal with frequencies outside the pass band of the receiver.

LIMIT

IEC 62238 Sub-clause 10.4.3

The bit error ratio shall be equal to or less than 10^{-2}

TEST CONFIGURATION

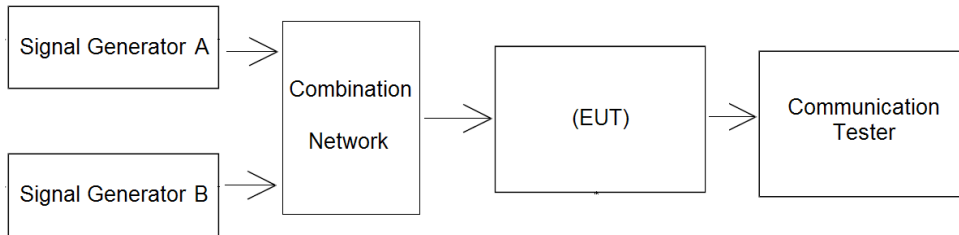

TEST PROCEDURE

1. The test conditions.

normal condition Extreme conditions

2. Please refer to IEC 62238 Sub-clause 10.4.2 for the measurement method

TEST MODE:

Please reference to the section 3.4

TEST RESULTS

Passed Not Applicable

Please refer to appendix AE on the section 8 appendix report

5.4.5. Intermodulation response

The intermodulation response is a measure of the capability of the receiver to receive a wanted modulated signal without exceeding a given degradation due to the presence of two or more unwanted signals with a specific frequency relationship to the wanted signal frequency.

LIMIT

IEC 62238 Sub-clause 10.5.3

The bit error ratio shall be equal to or less than 10^{-2}

TEST CONFIGURATION

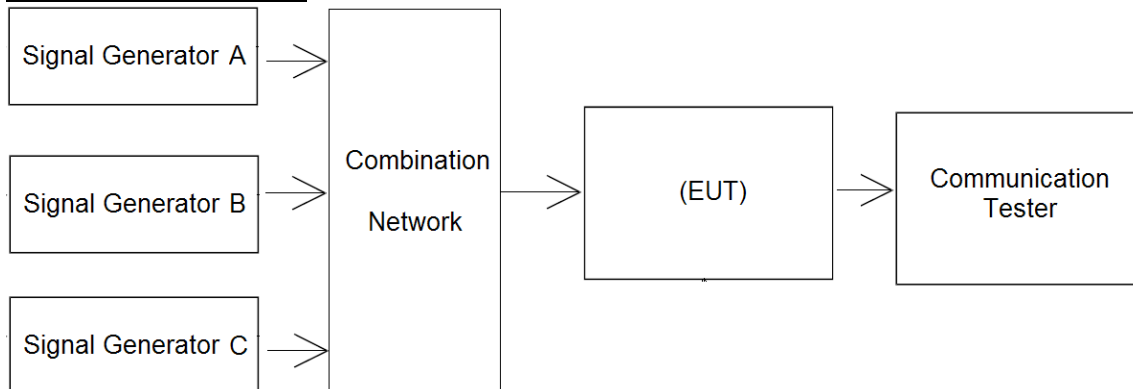

TEST PROCEDURE

1. The test conditions.

normal condition

Extreme conditions

2. Please refer to IEC 62238 Sub-clause 10.5.2 for the measurement method.

TEST MODE:

Please reference to the section 3.4

TEST RESULTS

Passed

Not Applicable

Please refer to appendix AF on the section 8 appendix report

5.4.6. Dynamic range

The dynamic range of the equipment is the range from the minimum to the maximum level of a radio frequency input signal at which the bit error ratio in the output of the decoder does not exceed a specified value.

Limit

IEC 62238 Sub-clause 10.6.3

The bit error ratio shall be equal to or less than 10^{-2} .

TEST CONFIGURATION

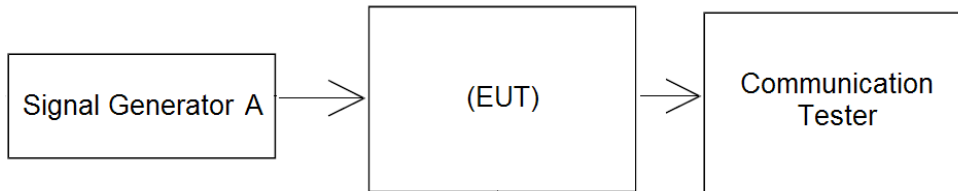

TEST PROCEDURE

1. The test conditions.

normal condition Extreme conditions

2. Please refer to IEC 62238 Sub-clause 10.6.2 for the measurement method

TEST MODE:

Please reference to the section 3.4

TEST RESULTS

Passed Not Applicable

Please refer to appendix AG on the section 8 appendix report

5.4.7. Spurious emissions

Spurious emissions from the receiver are components at any frequency, present at the receiver input port.

The level of spurious emissions shall be measured as the power level at the antenna.

Limit

IEC 62238 Sub-clause 10.7.3

The power of any spurious emission shall not exceed 2 nW at any frequency in the range between 9 kHz and 2 GHz.

TEST CONFIGURATION

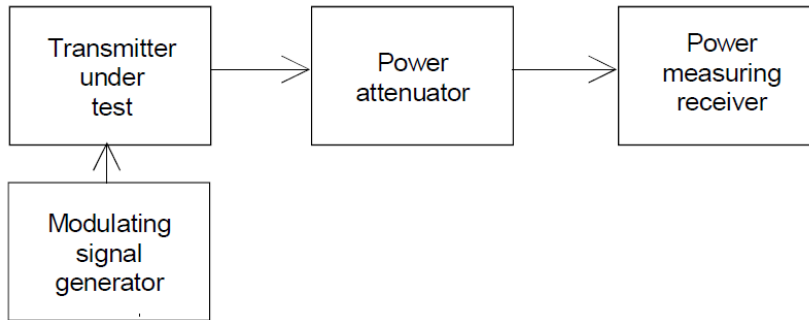

TEST PROCEDURE

1. The test conditions.

normal condition Extreme conditions

2. Please refer to IEC 62238 Sub-clause 10.7.2 for the measurement method.

TEST MODE:

Please reference to the section 3.4

TEST RESULTS

Passed Not Applicable

Please refer to appendix AH on the section 8 appendix report

5.4.8. Verification of correct decoding of various types of DSC calls

DSC call sequences are calls that comply with ITU-R Recommendation M.493-14.

Requirement

The requirements of ITU-R Recommendation M.493-14 regarding message composition and content shall be met.

The decoded call sequences at the output of the receiver shall be examined for correct technical format, including error-check characters.

When receiver measurements are made by use of a printer or a computer, a check shall be made to ensure accordance between printer output and display indication.

It shall be verified that the equipment is capable of switching to a channel identified in the DSC call.

TEST RESULTS

Passed **Not Applicable**

Please refer to appendix AI on the section 8 appendix report

5.4.9. Reaction to VTS and AIS channel management DSC transmissions

VTS and AIS channel management DSC transmissions are any DSC transmissions that are in accordance with Recommendation ITU-R M.825 or M.1371.

Requirement

The equipment shall not sound an alarm, display a message (an accurate, informative display is permissible but not required), transmit a response or suggest a transmitted response, lock up, or require operator intervention.

TEST RESULTS

Passed **Not Applicable**

Please refer to appendix AJ on the section 8 appendix report

5.4.10. Simultaneous reception

Simultaneous reception is the ability of the unit to correctly receive DSC traffic and radiotelephony traffic at the same time.

Limit

IEC 62238 Sub-clause 10.10.3

The bit error ratio shall be equal to or less than 10^{-2}

TEST CONFIGURATION

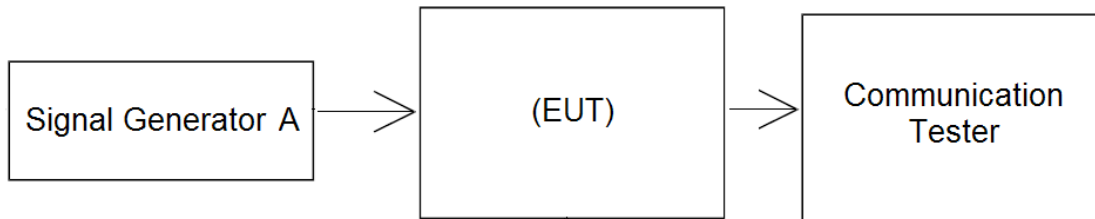

TEST PROCEDURE

1. The test conditions.

normal condition Extreme conditions

2. Please refer to IEC 62238 Sub-clause 10.10.2 for the measurement method.

TEST MODE:

Please reference to the section 3.4

TEST RESULTS

Passed Not Applicable

Please refer to appendix AK on the section 8 appendix report

6. External and Internal Photos of the EUT

Reference to the test report No.: CHTEW22060048

-----End of Report-----

Appendix A: Frequency Error

Operation Mode	Test conditions		Frequency Error (kHz)	Limit (kHz)	Result
	Temperature	Voltage	CH _M		
TX-AWH	T _N	V _N	-0.633	±1.5	PASS
TX-AWH	T _L	V _L	-0.629	±1.5	PASS
TX-AWH	T _H	V _H	-0.643	±1.5	PASS
TX-AWL	T _N	V _N	-0.629	±1.5	PASS
TX-AWL	T _L	V _L	-0.621	±1.5	PASS
TX-AWL	T _H	V _H	-0.636	±1.5	PASS

Appendix B: Carrier power

Operation Mode	Temperature	Voltage	Test Channel	Measured power (dBm)	Rated power(W)	Difference (dB)	Limit (dB)	Result
TX-AWH	T_N	V_N	CH_L	43.96	25.00	-0.02	± 1.5	PASS
TX-AWH	T_N	V_N	CH_M	43.72	25.00	-0.26	± 1.5	PASS
TX-AWH	T_N	V_N	CH_H	43.87	25.00	-0.11	± 1.5	PASS
TX-AWH	T_L	V_L	CH_M	43.58	25.00	-0.40	-3 ~ +2	PASS
TX-AWH	T_H	V_H	CH_M	43.88	25.00	-0.10	-3 ~ +2	PASS
TX-AWL	T_N	V_N	CH_L	28.89	1.00	-1.11	± 1.5	PASS
TX-AWL	T_N	V_N	CH_M	28.85	1.00	-1.15	± 1.5	PASS
TX-AWL	T_N	V_N	CH_H	28.89	1.00	-1.11	± 1.5	PASS
TX-AWL	T_L	V_L	CH_M	28.71	1.00	-1.29	-3 ~ +2	PASS
TX-AWL	T_H	V_H	CH_M	28.94	1.00	-1.06	-3 ~ +2	PASS

Appendix C: Frequency Deviation

Modulation Frequency (kHz)	Frequency Deviation (kHz)	Limit (kHz)	Result	Modulation Frequency (kHz)	Frequency Deviation (kHz)	Limit (kHz)	Result
	TX-AWH				TX-AWL		
	CH _M				CH _M		
0.30	4.921	5.00	PASS	0.30	4.992	5.00	PASS
0.40	4.846	5.00	PASS	0.40	4.876	5.00	PASS
0.50	4.827	5.00	PASS	0.50	4.792	5.00	PASS
0.60	4.805	5.00	PASS	0.60	4.780	5.00	PASS
0.70	4.727	5.00	PASS	0.70	4.706	5.00	PASS
0.80	4.644	5.00	PASS	0.80	4.623	5.00	PASS
0.90	4.593	5.00	PASS	0.90	4.545	5.00	PASS
1.00	4.496	5.00	PASS	1.00	4.472	5.00	PASS
1.20	4.393	5.00	PASS	1.20	4.372	5.00	PASS
1.40	4.386	5.00	PASS	1.40	4.363	5.00	PASS
1.60	4.429	5.00	PASS	1.60	4.411	5.00	PASS
1.80	4.475	5.00	PASS	1.80	4.482	5.00	PASS
2.00	4.482	5.00	PASS	2.00	4.475	5.00	PASS
2.20	4.387	5.00	PASS	2.20	4.345	5.00	PASS
2.40	4.106	5.00	PASS	2.40	4.051	5.00	PASS
2.55	3.790	5.00	PASS	2.55	3.724	5.00	PASS
2.60	3.681	5.00	PASS	2.60	3.604	5.00	PASS
2.80	3.206	5.00	PASS	2.80	3.136	5.00	PASS
3.00	2.767	5.00	PASS	3.00	2.684	5.00	PASS
3.00	2.767	4.10	PASS	3.00	2.684	2.68	PASS
3.50	1.732	4.10	PASS	3.50	1.711	2.68	PASS
4.00	1.156	4.10	PASS	4.00	1.122	2.68	PASS
4.50	0.802	4.10	PASS	4.50	0.776	2.68	PASS
5.00	0.572	4.10	PASS	5.00	0.552	2.68	PASS
6.00	0.339	4.10	PASS	6.00	0.323	2.68	PASS
6.00	0.339	1.50	PASS	6.00	0.323	1.50	PASS
7.00	0.215	1.05	PASS	7.00	0.205	1.05	PASS
8.00	0.144	0.77	PASS	8.00	0.130	0.77	PASS
9.00	0.110	0.58	PASS	9.00	0.095	0.58	PASS
10.00	0.094	0.46	PASS	10.00	0.075	0.46	PASS
11.00	0.085	0.37	PASS	11.00	0.071	0.37	PASS
12.00	0.088	0.30	PASS	12.00	0.070	0.30	PASS
14.00	0.090	0.21	PASS	14.00	0.070	0.21	PASS
16.00	0.074	0.15	PASS	16.00	0.069	0.15	PASS
18.00	0.077	0.12	PASS	18.00	0.080	0.12	PASS
20.00	0.088	0.09	PASS	20.00	0.076	0.09	PASS
22.00	0.061	0.07	PASS	22.00	0.069	0.07	PASS
24.00	0.053	0.06	PASS	24.00	0.047	0.06	PASS
25.00	0.042	0.05	PASS	25.00	0.037	0.05	PASS

Appendix C: Frequency Deviation

TEST PLOT RESULT

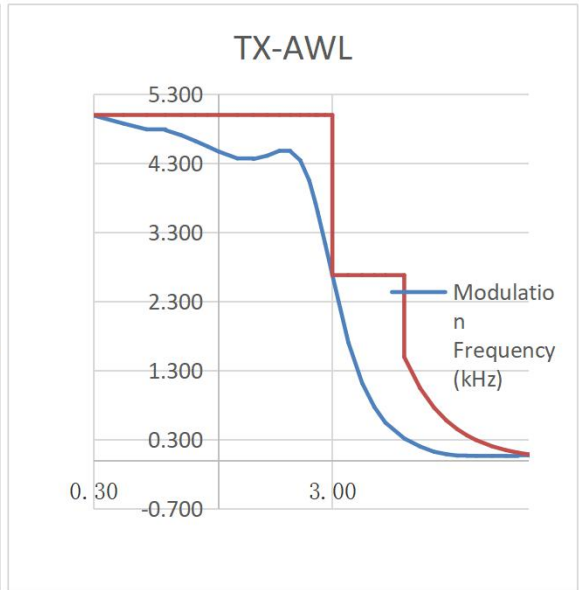
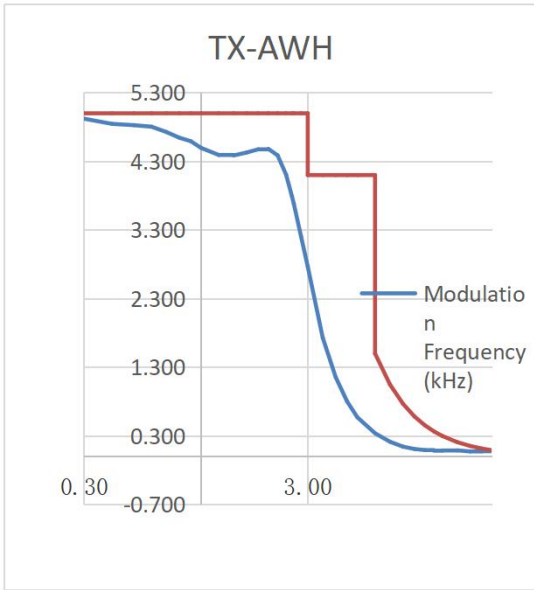

Appendix D: Sensitivity of the modulaotr, including microphone

Operation Mode	Test Channel	Modulated Frequency (kHz)	Measured (kHz)	Limit(kHz)	Result
TX-AWH	CH _M	1.0	3.6	±2.5~ ±4.5	PASS
TX-AWH	CH _M	0.3	3.2	±2.5~ ±4.5	PASS
TX-AWH	CH _M	0.5	3.5	±2.5~ ±4.5	PASS

Appendix E: Audio frequency response

Frequency (KHz)	Frequency Deviation (KHz)	1KHz Reference Deviation (KHz)	Audio Frequency Response (dB)
	TX-AWH		
	CH _M		
0.3	0.30	1.00	-10.58
0.4	0.39	1.00	-8.27
0.5	0.49	1.00	-6.25
0.6	0.59	1.00	-4.55
0.7	0.68	1.00	-3.37
0.8	0.77	1.00	-2.24
0.9	0.86	1.00	-1.28
1	0.95	1.00	-0.43
1.2	1.14	1.00	1.17
1.4	1.33	1.00	2.48
1.6	1.53	1.00	3.72
1.8	1.73	1.00	4.74
2	1.91	1.00	5.62
2.2	2.07	1.00	6.33
2.55	2.30	1.00	7.23
2.4	2.22	1.00	6.94
2.6	2.33	1.00	7.33
2.7	2.38	1.00	7.52
2.8	2.39	1.00	7.58
3	2.40	1.00	7.62

Appendix E: Audio frequency response

TEST PLOT RESULT

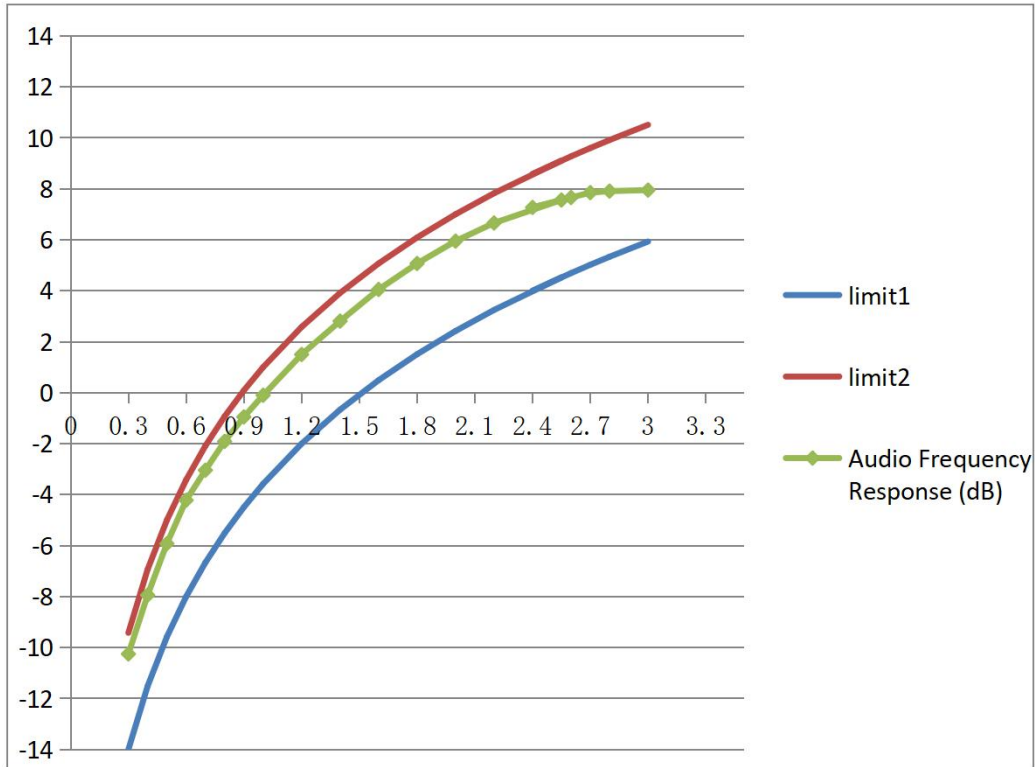

Appendix F: Audio frequency harmonic distortion of the emission

Operation Mode	Temperature (°C)	Voltage (V)	Modulated Frequency (kHz)	Test Channel	Measured (%)	Limit (%)	Result
TX-AWH	T _N	V _N	0.3	CH _M	6.3	≤10	PASS
			0.5	CH _M	4.2	≤10	PASS
			1.0	CH _M	2.9	≤10	PASS
TX-AWL	T _N	V _N	0.3	CH _M	6.2	≤10	PASS
			0.5	CH _M	4.3	≤10	PASS
			1.0	CH _M	3.0	≤10	PASS

Appendix G: Adjacent Channel Power

Operation Mode	Test Channel	Test Channel	Measurement Power (dBc)	Limit (dB)	Result
TX-AWH	CH _M	Lower adjacent	-70.64	≤-70	PASS
TX-AWH	CH _M	Upper adjacent	-70.39	≤-70	PASS

Appendix H: Conducted spurious emissions conveyed to the antenna

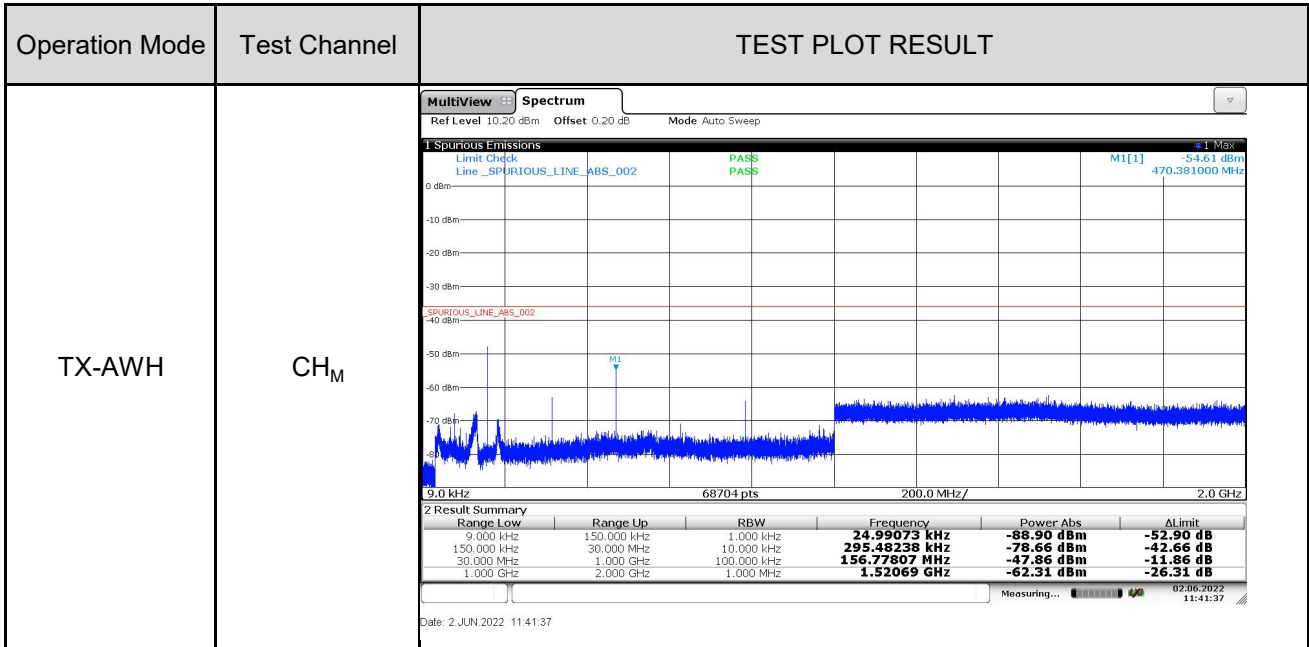

Appendix I:Transient frequency behaviour of the transmitter

Operation Mode	Modulation Type	Test Channel	TEST PLOT RESULT																								
TX-AWH	FM	CH _M	<table border="1"> <thead> <tr> <th colspan="4">4 Result Summary</th> <th colspan="2">Carrier Power 32.96 dBm</th> <th colspan="2">Carrier Offset -160.82 Hz</th> </tr> <tr> <th>FM</th> <th>+Peak</th> <th>-Peak</th> <th>+Peak/2</th> <th>RMS</th> <th>Mod. Freq.</th> <th>SINAD</th> <th>THD</th> </tr> </thead> <tbody> <tr> <td></td> <td>53.86 kHz</td> <td>-52.581 kHz</td> <td>53.221 kHz</td> <td>8.9175 kHz</td> <td>---</td> <td>---</td> <td>---</td> </tr> </tbody> </table>	4 Result Summary				Carrier Power 32.96 dBm		Carrier Offset -160.82 Hz		FM	+Peak	-Peak	+Peak/2	RMS	Mod. Freq.	SINAD	THD		53.86 kHz	-52.581 kHz	53.221 kHz	8.9175 kHz	---	---	---
4 Result Summary				Carrier Power 32.96 dBm		Carrier Offset -160.82 Hz																					
FM	+Peak	-Peak	+Peak/2	RMS	Mod. Freq.	SINAD	THD																				
	53.86 kHz	-52.581 kHz	53.221 kHz	8.9175 kHz	---	---	---																				
TX-AWH	FM	CH _M	<table border="1"> <thead> <tr> <th colspan="4">4 Result Summary</th> <th colspan="2">Carrier Power 32.97 dBm</th> <th colspan="2">Carrier Offset -192.25 Hz</th> </tr> <tr> <th>FM</th> <th>+Peak</th> <th>-Peak</th> <th>+Peak/2</th> <th>RMS</th> <th>Mod. Freq.</th> <th>SINAD</th> <th>THD</th> </tr> </thead> <tbody> <tr> <td></td> <td>41.137 kHz</td> <td>-44.729 kHz</td> <td>42.933 kHz</td> <td>5.824 kHz</td> <td>---</td> <td>---</td> <td>---</td> </tr> </tbody> </table>	4 Result Summary				Carrier Power 32.97 dBm		Carrier Offset -192.25 Hz		FM	+Peak	-Peak	+Peak/2	RMS	Mod. Freq.	SINAD	THD		41.137 kHz	-44.729 kHz	42.933 kHz	5.824 kHz	---	---	---
4 Result Summary				Carrier Power 32.97 dBm		Carrier Offset -192.25 Hz																					
FM	+Peak	-Peak	+Peak/2	RMS	Mod. Freq.	SINAD	THD																				
	41.137 kHz	-44.729 kHz	42.933 kHz	5.824 kHz	---	---	---																				

Appendix J: Residual modulation of the transmitter

Operation Mode	Test Channel	Measured (dB)	Limit(dB)	Result
TX-AWH	CH _M	-40.38	≤-40	PASS

Appendix K: Frequency error (demodulated DSC signal)

Operation Mode	Test conditions		Frequency Error (Hz)	Limit (Hz)	Result
	Temperature	Voltage			
TX-B	T_N	V_N	2099.74	2100 ± 10	PASS
TX-B	T_L	V_L	2099.66	2100 ± 10	PASS
TX-B	T_H	V_H	2099.50	2100 ± 10	PASS
TX-Y	T_N	V_N	1299.84	1300 ± 10	PASS
TX-Y	T_L	V_L	1299.72	1300 ± 10	PASS
TX-Y	T_H	V_H	1299.77	1300 ± 10	PASS

Appendix L: Modulation index for DSC

Operation Mode	Test Channel	Modulation index	Limit	Result
TX-B	CH _{M1}	1.94	2.0± 10%	PASS
TX-Y	CH _{M1}	1.96	2.0± 10%	PASS

Appendix M: Modulation rate for DSC

Operation Mode	Test Channel	Modulation rate (Hz)	Limit	Result
TX-(B+Y)	CH _{M1}	599.995	600Hz ± 30 ppm	PASS

Appendix N: Testing of generated call sequences

Call Sent	Received without error	Telecommand 1	Telecommand 2
Distress	Yes	100	126
All Ships Urgency	Yes	100	126
All Ships Safety	Yes	110	126
Individual Routine	Yes	110	126
Group Routine	Yes	100	126

Appendix O: Harmonic distortion and rated audio frequency output power

Harmonic distortion								
Operation Mode	Temperature (°C)	Voltage (V)	Signal Level (dB μ V)	Modulated Frequency (kHz)	Test Frequency	Measured (%)	Limit (%)	Result
RX-AW	T_N	V_N	60	0.3	CH _M	3.1	≤ 10	PASS
				0.5	CH _M	2.2	≤ 10	PASS
				1.0	CH _M	8.4	≤ 10	PASS
			100	0.3	CH _M	3.0	≤ 10	PASS
				0.5	CH _M	2.3	≤ 10	PASS
				1.0	CH _M	8.2	≤ 10	PASS

rated audio frequency output power			
TestChannel	Measured (W)	Limit (W)	Result
CH _M	2.210	≥ 2	PASS

Appendix P:Audio frequency response

RX-AW:CH _M			
Frequency (kHz)	Output Level(V)	Reference Level at 1kHz (V)	Audio Frequency Response(dB)
0.3	1.1976	0.3824	9.92
0.4	0.9757	0.3824	8.14
0.5	0.8508	0.3824	6.95
0.6	0.7093	0.3824	5.37
0.7	0.6023	0.3824	3.95
0.8	0.5424	0.3824	3.04
0.9	0.4768	0.3824	1.92
1	0.4215	0.3824	0.85
1.2	0.3510	0.3824	-0.74
1.4	0.3078	0.3824	-1.88
1.6	0.2740	0.3824	-2.89
1.8	0.2368	0.3824	-4.16
2	0.2179	0.3824	-4.88
2.2	0.1876	0.3824	-6.18
2.55	0.1729	0.3824	-6.89
2.4	0.1759	0.3824	-6.74
2.6	0.1621	0.3824	-7.45
2.7	0.1511	0.3824	-8.06
2.8	0.1462	0.3824	-8.35
3	0.1289	0.3824	-9.44

Appendix P:Audio frequency response

TEST PLOT RESULT

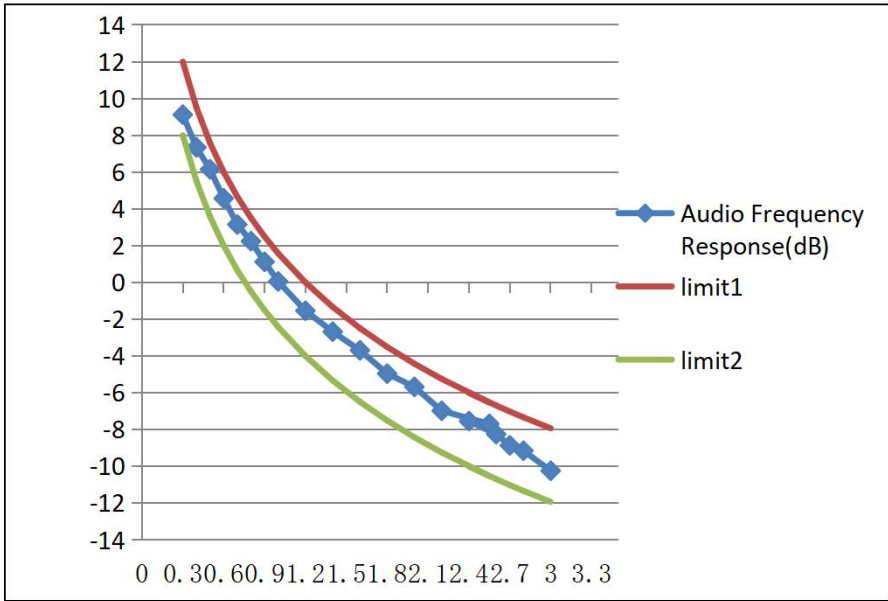

Appendix Q: Maximum Usable Sensitivity(Conducted)

Operation Mode	Temperature	Voltage	Test Channel	Measured (dB μ V)	Limit (dB μ V)	Result
RX-AW	T_N	V_N	CH _M	-8.2	$\leq +6.0$	PASS
RX-AW	T_L	V_L	CH _M	-7.9	$\leq +12.0$	PASS
RX-AW	T_H	V_H	CH _M	-8.3	$\leq +12.0$	PASS

Appendix R: Co-Channel Rejection

Operation Mode	Test Channel	Measurement Offset (kHz)	SG B – SG A	Limit (dB)	Result
			(dB)		
RX-AW	CH _M	-3	-0.2	-10 ~ 0	PASS
RX-AW	CH _M	0	-2.3	-10 ~ 0	PASS
RX-AW	CH _M	3	-5.0	-10 ~ 0	PASS

Appendix S: Adjacent Channel Selectivity

Operation Mode	Test Condition		Test Channel	Measurement Position	SGB-SGA (dB)	Limit (dB)	Result
	Temperature	Voltage					
RX-AW	T_N	V_N	CH_M	Lower adjacent	74.8	≥ 70	PASS
RX-AW	T_N	V_N	CH_M	Upper adjacent	73.9	≥ 70	PASS
RX-AW	T_L	V_L	CH_M	Lower adjacent	74.5	≥ 60	PASS
RX-AW	T_L	V_L	CH_M	Upper adjacent	73.2	≥ 60	PASS
RX-AW	T_H	V_H	CH_M	Lower adjacent	74.9	≥ 60	PASS
RX-AW	T_H	V_H	CH_M	Upper adjacent	74.1	≥ 60	PASS

Appendix T: Suprious Response Rejection

Operation Mode	Test Channel	Detect Frequency (MHz)	SG B – SG A (dB)	Limit (dB)	Result
RX-AW	CH _M	166.790	102.0	≥70	PASS
RX-AW	CH _M	206.750	106.6	≥70	PASS
RX-AW	CH _M	256.700	107.7	≥70	PASS
RX-AW	CH _M	266.690	107.8	≥70	PASS

Appendix U: Intermodulation Response

Operation Mode	Test Channel	Measurement Offset (kHz)		SG B/C – SG A (dB)	Limit(dB)	Result
		SG B	SG C			
RX-AW	CH _M	-50	-100	68.6	≥68	PASS
RX-AW	CH _M	-25	-50	68.4	≥68	PASS
RX-AW	CH _M	25	50	68.1	≥68	PASS
RX-AW	CH _M	50	100	68.2	≥68	PASS

Appendix V: Blocking or Desensitization

Operation Mode	Test Channel	Measurement Offset (MHz)	SG B – SG A (dB)	Limit (dB)	Result
RX-AW	CH _M	-10	105.0	≥90	PASS
RX-AW	CH _M	-5	102.3	≥90	PASS
RX-AW	CH _M	-2	97.8	≥90	PASS
RX-AW	CH _M	-1	98.2	≥90	PASS
RX-AW	CH _M	1	100.5	≥90	PASS
RX-AW	CH _M	2	102.9	≥90	PASS
RX-AW	CH _M	5	102.7	≥90	PASS
RX-AW	CH _M	10	102.0	≥90	PASS

Appendix W: Conducted Spurious radiations

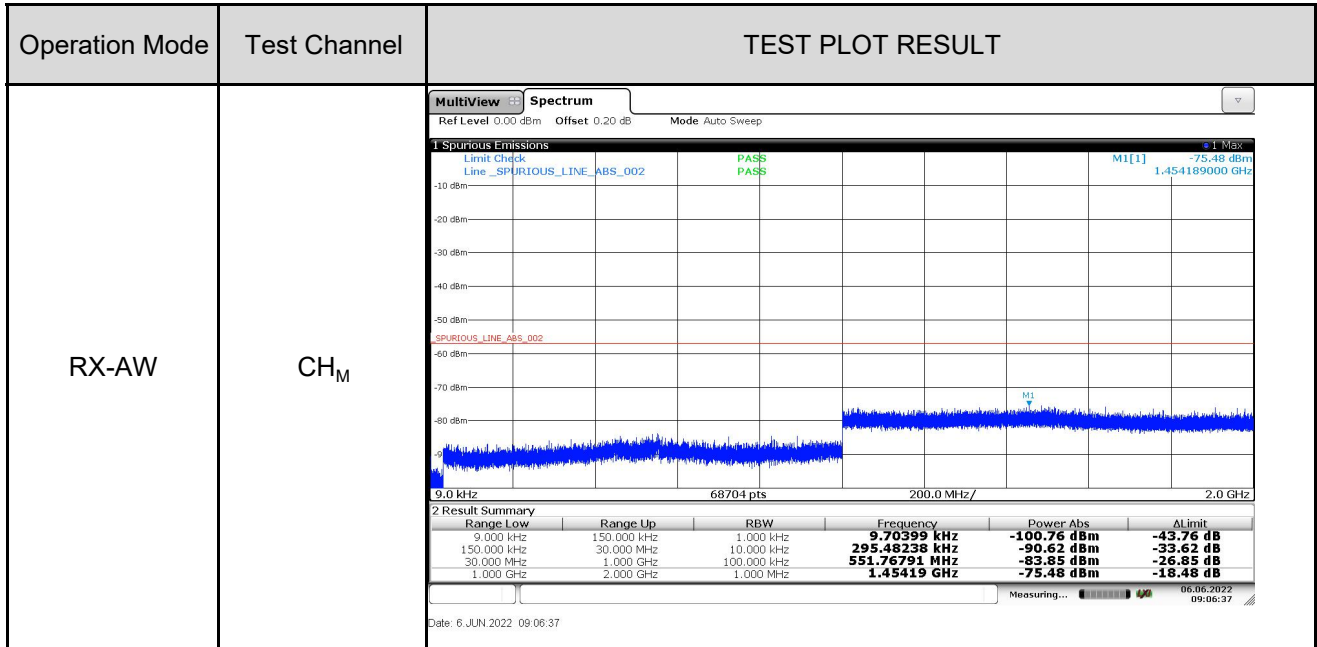

Appendix X: Receiver noise and hum level

Operation Mode	Test Channel	Measured (dB)	Limit (dB)	Result
RX-AW	CH _M	-40.83	≤-40	PASS

Appendix Y:Squelch operation

Under the conditions specified in a)

RX-AW			
Test Channel	Measured (dB)	Limit (dB)	Result
CH _M	-41.20	≤-40	PASS

Under the conditions specified in b)

RX-AW			
Test Channel	Measured (dBμV)	Limit (dBμV)	Result
CH _M	4.70	≤+6.0	PASS

RX-AW			
Test Channel	Measured SINAD (dB)	Limit (dBμV)	Result
CH _M	21.37	≥20	PASS

Under the conditions specified in c)

RX-AW			
Test Channel	Measured (dBμV)	Limit (dBμV)	Result
CH _M	4.6	≤+6.0	PASS

Appendix Z:Squelch hysteresis

RX-AW			
Test Channel	Measured (dB)	Limit (dB)	Result
CH _M	4.60	3~6	PASS

Appendix AA:Multiple watch characteristic

Scanning Period:

Operation Mode	Test Condition		Test Channel	Measured(s)	Limit (s)	Result
	Temperature (°C)	Voltage (V)				
RX-AW	T _N	V _N	CH _M	1.57	≤2	PASS
	T _L	V _L	CH _M	1.49	≤2	PASS
	T _H	V _H	CH _M	1.46	≤2	PASS

Dwell Time:

Operation Mode	Test Condition		Test Channel	Measured(ms)	Limit (ms)	Result
	Temperature (°C)	Voltage (V)				
RX-AW	T _N	V _N	CH _M	110	150	PASS
	T _L	V _L	CH _M	100	150	PASS
	T _H	V _H	CH _M	120	150	PASS

Dwell time on the additional channel:

Operation Mode	Test Condition		Test Channel	Measured(s)	Limit (s)	Result
	Temperature (°C)	Voltage (V)				
RX-AW	T _N	V _N	CH _M	1.34	0.85~2	PASS
	T _L	V _L	CH _M	1.25	0.85~2	PASS
	T _H	V _H	CH _M	1.38	0.85~2	PASS

Appendix AB: Maximum Usable Sensitivity

Operation Mode	Temperature	Voltage	Test Channel	Measured (error ratio)	Limit (error ratio)	Result
RX-DSC	T_N	V_N	CH _{M1}	0.003	$\leq 10^{-2}$	PASS
RX-DSC	T_L	V_L	CH _{M1}	0.005	$\leq 10^{-2}$	PASS
RX-DSC	T_H	V_H	CH _{M1}	0.002	$\leq 10^{-2}$	PASS

Appendix AC: Co-Channel Rejection

Operation Mode	Test Channel	Measurement Offset (kHz)	Measured (error ratio)	Limit (error ratio)	Result
RX-DSC	CH _{M1}	-3	0.003	$\leq 10^{-2}$	PASS
RX-DSC	CH _{M1}	0	0.005	$\leq 10^{-2}$	PASS
RX-DSC	CH _{M1}	3	0.006	$\leq 10^{-2}$	PASS

Appendix AD: Adjacent channel selectivity

Operation Mode	Test Condition		Test Channel	Measurement Position	Measured (error ratio)	Limit (error ratio)	Result
	Temperature	Voltage					
RX-DSC	T_N	V_N	CH_{M1}	Lower adjacent	0.007	$\leq 10^{-2}$	PASS
RX-DSC	T_N	V_N	CH_{M1}	Upper adjacent	0.003	$\leq 10^{-2}$	PASS
RX-DSC	T_L	V_L	CH_{M1}	Lower adjacent	0.004	$\leq 10^{-2}$	PASS
RX-DSC	T_L	V_L	CH_{M1}	Upper adjacent	0.007	$\leq 10^{-2}$	PASS
RX-DSC	T_H	V_H	CH_{M1}	Lower adjacent	0.005	$\leq 10^{-2}$	PASS
RX-DSC	T_H	V_H	CH_{M1}	Upper adjacent	0.006	$\leq 10^{-2}$	PASS

Appendix AE: Spurious response and blocking immunity

Spurious response:

Operation Mode	Test Channel	Spurious Frequency (MHz)	Measured (error ratio)	Limit (error ratio)	Result
RX-DSC	CH _{M1}	166.515	0.007	$\leq 10^{-2}$	PASS
		206.475	0.005		
		256.425	0.004		
		266.415	0.002		

Blocking immunity:

Operation Mode	Test Channel	Measurement Offset (MHz)	Measured (error ratio)	Limit (error ratio)	Result
RX-DSC	CH _{M1}	-10	0.002	$\leq 10^{-2}$	PASS
		-5	0.003		
		-2	0.005		
		-1	0.008		
		1	0.007		
		2	0.005		
		5	0.004		
		10	0.002		

Appendix AF: Intermodulation response

Operation Mode	Test Channel	Measurement Offset (kHz)		Measured (error ratio)	Limit (error ratio)	Result
		SG B	SG C			
RX-DSC	CH _{M1}	-50	-100	0.005	$\leq 10^{-2}$	PASS
		50	100	0.007	$\leq 10^{-2}$	PASS

Appendix AG: Dynamic range

Operation Mode	Test Channel	Measured (error ratio)	Limit (error ratio)	Result
RX-DSC	CH _{M1}	0.003	$\leq 10^{-2}$	PASS

Appendix AH: spurious emissions

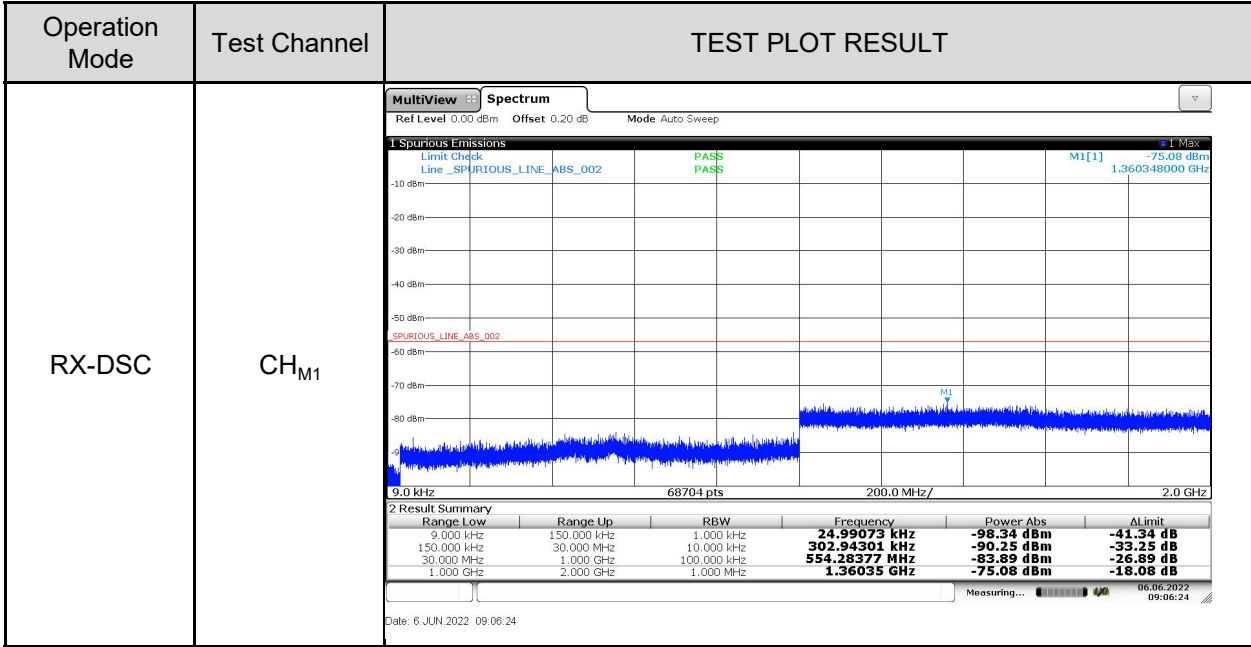

Appendix AI: Verification of correct decoding of various types of DSC calls

Call Sent	Received (Y or N)	Telecommand 1	Telecommand 2
Distress	Y	100	126
All Ships Distress Ack	Y	110	126
All Ships Distress Relay	Y	110	126
All Ships Urgency	Y	100	126
All Ships Safety	Y	110	126
Individual Urgency	Y	100	126
Individual Safety	Y	110	126
Individual Routine	Y	100	126
Group Routine	Y	100	126

Function Check	Result
Confirm that the decoded call sequences at the output of the receiver have been examined for correct technical format, including error check characteristics.	Yes
Errors found:	No
Confirm that the checks have been made to ensure accordance between printer output and display	Yes
Errors found:	No
It has been verified that the equipment is capable of switching to a channel identified in the DSC call:	Yes

Appendix AJ: Reaction to VTS and AIS channel management DSC transmissions

Function Check	Received (Y or N)
Not sound an alarm	Y
Not display a message(An accurate informative display is permissible but not required)	Y
Not transmit a response	Y
Not suggest a transmitted response	Y
Not lock up	Y
Not require operator intervention	Y

Appendix AK: Simultaneous reception

Operation Mode	Test Channel	Measured SINAD(dB)	Limit (dB)	Result
RX-AW	CH _M	21.34	≥ 20	PASS

Operation Mode	Test Channel	Measured (error ratio)	Limit ((error ratio))	Result
RX-DSC	CH _{M1}	0.004	$\leq 10^{-2}$	PASS

-----End of Report-----