



TEST REPORT

Report No. : **CHTEW22120001** Report Verification: 

Project No..... : **SHT2209079801EW**

FCC ID..... : **2A3OORB48**

Applicant's name..... : **Shenzhen Ysair Technology Co., LTD**

Address..... : 6/F, building 6, Yunli intelligent park, No. 3, Changfa Middle Road, Yangmei community, Bantian street, Longgang District, Shenzhen,Guangdong,China

Test item description : **Two Way Radio**

Trade Mark : RETEVIS

Model/Type reference..... : RB48

Listed Model(s) : -



Standard : **FCC CFR Title 47 Part 95 Subpart B**

Date of receipt of test sample..... : Nov.18, 2022

Date of testing..... : Nov.18, 2022- Dec.06, 2022

Date of issue..... : Dec.06, 2022

Result..... : **PASS**

Compiled by (Position+Printed name+Signature):	File administrator Fanghui Zhu	
Supervised by (Position+Printed name+Signature):	Project Engineer Xiaodong Zhao	
Approved by (Position+Printed name+Signature):	RF Manager Hans Hu	

Testing Laboratory Name : **Shenzhen Huatongwei International Inspection Co., Ltd.**

Address..... : 1/F, Bldg 3, Hongfa Hi-tech Industrial Park, Genyu Road, Tianliao, Gongming, Shenzhen, China

Shenzhen Huatongwei International Inspection Co., Ltd. All rights reserved.
 This publication may be reproduced in whole or in part for non-commercial purposes as long as the Shenzhen Huatongwei International Inspection Co., Ltd. is acknowledged as copyright owner and source of the material. Shenzhen Huatongwei International Inspection Co., Ltd. takes no responsibility for and will not assume liability for damages resulting from the reader's interpretation of the reproduced material due to its placement and context. The test report merely correspond to the test sample.

Contents

1.	<u>TEST STANDARDS AND REPORT VERSION</u>	3
1.1.	Test Standards	3
1.2.	Report version	3
2.	<u>TEST DESCRIPTION</u>	4
3.	<u>SUMMARY</u>	5
3.1.	Client Information	5
3.2.	Product Description	5
3.3.	Radio Specification Description	5
3.4.	Testing Laboratory Information	6
4.	<u>TEST CONFIGURATION</u>	7
4.1.	Test frequency list	7
4.2.	Test mode	7
4.3.	Support unit used in test configuration and system	8
4.4.	Testing environmental condition	9
4.5.	Measurement uncertainty	9
4.6.	Equipment Used during the Test	10
5.	<u>TEST CONDITIONS AND RESULTS</u>	11
5.1.	Carrier Output Power (ERP)	11
5.2.	99% Occupied Bandwidth & 26dB Bandwidth	12
5.3.	Emission Mask	13
5.4.	Modulation Limit	14
5.5.	Audio Frequency Response	15
5.6.	Audio Low Pass Filter Response	17
5.7.	Frequency stability VS Temperature	18
5.8.	Frequency stability VS Voltage	19
5.9.	Transmit Radiated Spurious Emission	20
6.	<u>TEST SETUP PHOTOS</u>	24
7.	<u>EXTERANAL AND INTERNAL PHOTOS</u>	26
7.1.	EXTERANAL PHOTOS	26
7.2.	INTERNAL PHOTOS	29
8.	<u>APPENDIX REPORT</u>	31

1. TEST STANDARDS AND REPORT VERSION

1.1. Test Standards

The tests were performed according to following standards:

- [FCC Rules Part 95](#): PERSONAL RADIO SERVICES
- [FCC Rules Part 2](#): Frequency allocations and radio treaty matters; General rules and regulations
- [ANSI C63.26-2013](#): American National Standard for Compliance Testing of Transmitters Used in Licensed Radio Services

1.2. Report version

Revision No.	Date of issue	Description
N/A	2022-12-06	Original

2. TEST DESCRIPTION

Report clause	Test Items	Standard Requirement	Result
5.1	Carrier Output Power (ERP)	Part 95.567 Part 2.1046(a)	PASS
5.2	99% Occupied Bandwidth & 26dB bandwidth	Part 95.573 Part 2.1049	PASS
5.3	Emission Mask	Part 95.579(a)(1)(2)(3) Part 2.1049	PASS
5.4	Modulation Limit	Part 95.575 Part 2.1047(b)	PASS
5.5	Audio Frequency Response	Part 95.575 Part 2.1047(a)	PASS
5.6	Audio Low Pass Filter Response	Part 95.575 Part 2.1047(a)	PASS
5.7	Frequency Stability V.S. Temperature	Part 95.565 Part 2.1055	PASS
5.8	Frequency Stability V.S. Voltage	Part 95.565 Part 2.1055	PASS
5.9	Transmit Radiated Spurious Emission	Part 95.579(a)(3) Part 2.1053	PASS

Note:

- The measurement uncertainty is not included in the test result.

3. SUMMARY

3.1. Client Information

Applicant:	Shenzhen Ysair Technology Co., LTD
Address:	6/F, building 6, Yunli intelligent park, No. 3, Changfa Middle Road, Yangmei community, Bantian street, Longgang District, Shenzhen,Guangdong,China
Manufacturer:	Shenzhen Ysair Technology Co., LTD
Address:	6/F, building 6, Yunli intelligent park, No. 3, Changfa Middle Road, Yangmei community, Bantian street, Longgang District, Shenzhen,Guangdong,China

3.2. Product Description

Name of EUT:	Two Way Radio
Trade Mark:	RETEVIS
Model No.:	RB48
Listed Model(s):	-
Power supply:	DC 3.7V from battery
Battery information:	Model: BL648 Voltage: 3.7V Capacity: 2000mAh(7.4Wh)
Charger information:	Model: DC648 Input: 5V/1A Output: 5V/480mA*2
Hardware version:	V1.02
Software version:	V1.02

3.3. Radio Specification Description

Support Frequency Range:	CH01~CH07:	462.5625MHz~ 462.7125MHz
	CH08~CH14:	467.5625MHz~ 467.7125MHz
	CH15~CH22:	462.5500MHz~ 462.7250MHz
Rated Output Power:	Hight: 2W	Low: 0.5W
Modulation Type:	FM	
Emission Designator: *1	11K0F3E	
Antenna Type:	Integral	
Antenna Gain:	2.0dBi	

Note:

- (1) *1 According to FCC Part 2.202 requirements, the Necessary Bandwidth is calculated as follows:
 - For FM Voice Modulation
Channel Spacing = 12.5 KHz, D = 2.5 KHz max, K = 1, M = 3 KHz
 $B_n = 2M + 2DK = 2*3 + 2*2.5*1 = 11 \text{ KHz}$
Emission designation: 11K0F3E
- (2) The device only supports voice communication.

3.4. Testing Laboratory Information

Laboratory Name	Shenzhen Huatongwei International Inspection Co., Ltd.	
Laboratory Location	1/F, Bldg 3, Hongfa Hi-tech Industrial Park, Genyu Road, Tianliao, Gongming, Shenzhen, China	
Connect information:	Tel: 86-755-26715499 E-mail: cs@szhtw.com.cn http://www.szhtw.com.cn	
Qualifications	Type	Accreditation Number
	FCC	762235

4. TEST CONFIGURATION

4.1. Test frequency list

According to ANSI C63.26 section 5.1.2.1:

Measurements of transmitters shall be performed and, if required, reported for each frequency band in which the EUT can be operated with the device transmitting at the number of frequencies in each band specified in Table 2.

Frequency range over which EUT operates	Number of frequencies	Location in frequency range of operation
1 MHz or less	1	Middle
1 MHz to 10 MHz	2	1 near top and 1 near bottom
More than 10 MHz	3	1 near top, 1 near middle, and 1 near bottom

Test Channel	Channel No.	Frequency (MHz)	Frequency band (MHz)
CH _{L-H}	CH4	462.6375	462.5625~462.7125 462.5500~462.7250
CH _{L-L}	CH4	462.6375	462.5625~462.7125 462.5500~462.7250
CH _H	CH11	467.6375	467.5625~467.7125

The Product channel frequency table:

Test Channel	Channel No.	Frequency (MHz)	Frequency band (MHz)
01	462.5625	12	467.6625
02	462.5875	13	467.6875
03	462.6125	14	467.7125
04	462.6375	15	462.5500
05	462.6625	16	462.5750
06	462.6875	17	462.6000
07	462.7125	18	462.6250
08	467.5625	19	462.6500
09	467.5875	20	462.6750
10	467.6125	21	462.7000
11	467.6375	22	462.7250

4.2. Test mode

Test mode	Transmitting	Receiving
TX-FRS	■	
RX-FRS		■

Note:

■: is operation mode.

Modulation Type	Description
UM	Un-modulation
AM2	Apply a 1000 Hz tone and adjust the audio frequency generator to produce 20% of the rated system deviation.
AM6	Apply a 1000 Hz modulating signal to the transmitter from the audio frequency generator, and adjust the level to obtain 60% of full rated system deviation, then increase the level from the audio generator by 20 dB
AM5	Modulate the transmitter with a 2500 Hz sine wave at an input level 16 dB greater than that necessary to produce 50% of rated system deviation.

Test item	Modulation Type	Test mode
Output Power (ERP)	UM	TX-FRS
99% Occupied Bandwidth & 26dB bandwidth	AM6	TX-FRS
Emission Mask	AM5	TX-FRS
Modulation Limit	AM6	TX-FRS
Audio Frequency Response	AM2	TX-FRS
Frequency Stability VS Temperature	UM	TX-FRS
Frequency Stability VS Voltage	UM	TX-FRS
Transmit Radiated Spurious Emission	AM5	TX-FRS

4.3. Support unit used in test configuration and system

The EUT has been associated with peripherals and configuration operated in a manner tended to maximize its emission characteristics in a typical application.

The following peripheral devices and interface cables were connected during the measurement:

Whether support unit is used?					
✓ No					
Item	Equipment	Trade Name	Model No.	FCC ID	Power cord
1					
2					

4.4. Testing environmental condition

Type	Requirement	Actual
Temperature:	15~35°C	25°C
Relative Humidity:	25~75%	50%
Air Pressure:	860~1060mbar	1000mbar
Test voltage:	Normal voltage:	DC 3.7V
	Extreme lower voltage:	DC 3.15V
	Extreme upper voltage:	DC 3.7V

4.5. Measurement uncertainty

Test Item	Measurement Uncertainty
Frequency stability	25 Hz
Carrier output power (ERP)	2.20 dB
Occupied Bandwidth	35 Hz
Modulation Limiting	0.42 %
FM deviation	25 Hz
Audio level	0.62 dB
Radiated Spurious Emission 30~1000MHz	4.65 dB
Radiated Spurious Emission 1~18GHz	5.16 dB
AC power line Conducted Emission 9KHz-30MHz	3.39 dB

This uncertainty represents an expanded uncertainty expressed at approximately the 95% confidence level using a coverage factor of $k=1.96$.

4.6. Equipment Used during the Test

● TS8613 Test system							
Used	Test Equipment	Manufacturer	Equipment No.	Model No.	Serial No.	Last Cal. Date (YY-MM-DD)	Next Cal. Date (YY-MM-DD)
●	Spectrum Analyzer	Agilent	HTWE0286	N9020A	MY50510187	2022/08/25	2023/08/24
●	Signal & Spectrum Analyzer	R&S	HTWE0262	FSW26	103440	2022/08/25	2023/08/24
●	RF Communication Test Set	HP	HTWE0038	8920A	3813A10206	2022/08/25	2023/08/24
●	Digital intercom communication tester	Aeroflex	HTWE0255	3920B	1001682041	2022/08/25	2023/08/24
●	Signal Generator	R&S	HTWE0191	SML02	100507	2022/08/25	2023/08/24
●	Signal Generator	R&S	HTWE0337	SMC100A	107268	2022/08/25	2023/08/24
●	RF Control Unit	Tonscend	HTWE0294	JS0806-2	N/A	N/A	N/A
●	Filter-VHF	Microwave	HTWE0309	N26460M1	498702	N/A	N/A
●	Filter-UHF	Microwave	HTWE0311	N25155M2	498704	N/A	N/A
●	Power Divider	Microwave	HTWE0043	OPD1040-N-4	N/A	2022/05/16	2023/05/15
●	Attenuator	JFW	HTWE0292	50FH-030-100	N/A	2022/05/16	2023/05/15
●	Attenuator	JFW	HTWE0293	50-A-MFN-20	0322	2022/05/16	2023/05/15
●	Test software	HTW	N/A	Radio ATE	N/A	N/A	N/A
● Auxiliary Equipment							
Used	Test Equipment	Manufacturer	Equipment No.	Model No.	Serial No.	Last Cal. Date (YY-MM-DD)	Next Cal. Date (YY-MM-DD)
●	Climate chamber	ESPEC	HTWE0254	GPL-2	N/A	2022/08/29	2023/08/28
●	DC Power Supply	Gwinstek	HTWE0274	SPS-2415	GER835793	N/A	N/A
● Radiated Spurious Emission							
Used	Test Equipment	Manufacturer	Equipment No.	Model No.	Serial No.	Last Cal. Date (YY-MM-DD)	Next Cal. Date (YY-MM-DD)
●	Semi-Anechoic Chamber	Albatross projects	HTWE0122	SAC-3m-01	C11121	2018/09/27	2023/09/26
●	Spectrum Analyzer	R&S	HTWE0098	FSP40	100597	2022/08/25	2023/08/24
●	Loop Antenna	R&S	HTWE0170	HFH2-Z2	100020	2021/04/06	2024/04/05
●	Broadband Horn Antenna	SCHWARZBECK	HTWE0103	BBHA9170	BBHA9170472	2020/04/27	2023/04/26
●	Ultra-Broadband Antenna	SCHWARZBECK	HTWE0123	VULB9163	538	2021/04/06	2024/04/05
●	Horn Antenna	SCHWARZBECK	HTWE0126	9120D	1011	2020/04/01	2023/03/31
●	Pre-amplifier	CD	HTWE0071	PAP-0102	12004	2022/11/04	2023/11/03
●	Broadband Preamplifier	SCHWARZBECK	HTWE0201	BBV 9718	9718-248	2022/02/28	2023/02/27
●	RF Connection Cable	HUBER+SUHNER	HTWE0120-01	6m 18GHz S Serisa	N/A	2022/02/25	2023/02/24
●	RF Connection Cable	HUBER+SUHNER	HTWE0120-02	6m 3GHz RG Serisa	N/A	2022/02/25	2023/02/24
●	RF Connection Cable	HUBER+SUHNER	HTWE0119-05	6m 3GHz RG Serisa	N/A	2022/02/25	2023/02/24
●	RF Connection Cable	HUBER+SUHNER	HTWE0120-04	6m 3GHz RG Serisa	N/A	2022/02/25	2023/02/24
●	EMI Test Software	Audix	N/A	E3	N/A	N/A	N/A

5. TEST CONDITIONS AND RESULTS

5.1. Carrier Output Power (ERP)

LIMIT

FCC Part FCC Part 95.567, FCC Part 2.1046

Each FRS transmitter type must be designed such that the effective radiated power (ERP) on channels 8 through 14 does **not exceed 0.5 Watts** and the ERP on channels 1 through 7 and 15 through 22 does **not exceed 2.0 Watts**.

TEST CONFIGURATION

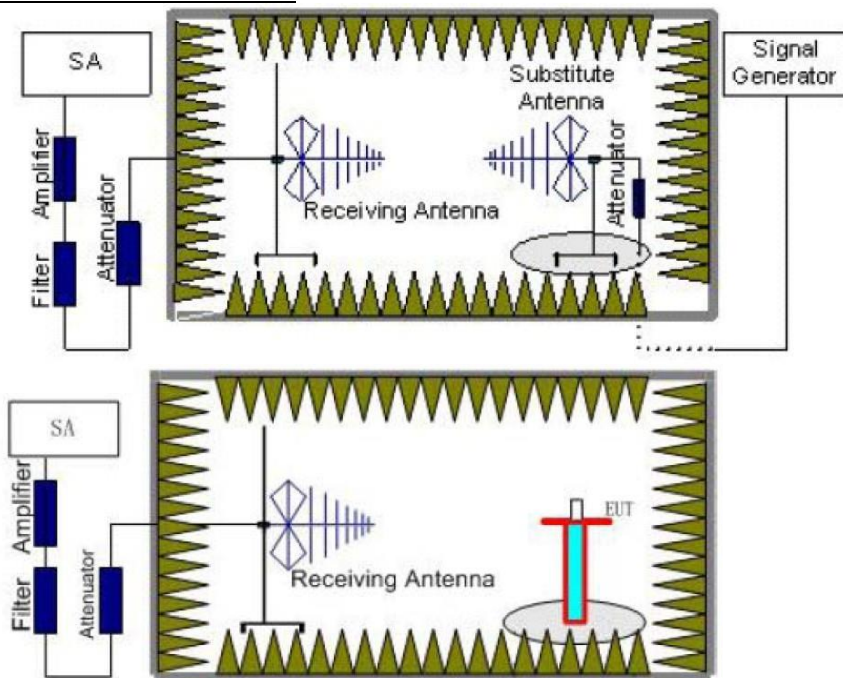

TEST PROCEDURE

- 1) The measuring distance of at 3m shall be used for measurements
- 2) The EUT was placed on the top of a rotating table 0.8 meters above the ground at a 3 meter semi-anechoic chamber. The table was rotated 360 degrees to determine the position of the highest radiation
- 3) The height of the equipment or of the substitution antenna shall be 0.8 m; the height of the test antenna shall vary between 1 m to 4 m. Both horizontal and vertical polarizations of the antenna are set to make the measurement.
- 4) The spectrum setting for Equivalent Isotropically Radiated Power (EIRP) is RBW = 100kHz, VBW = 300kHz. Detector Mode is Positive Peak
- 5) Record the field strength level of the EUT from the spectrum
- 6) The substitution antenna is substituted for EUT at the same position and signals generator (S.G) export the CW signal to the substitution antenna via a TX cable. The receiver antenna shall be moved height from 1m to 4m to find the highest radiation. Adjust the S.G. output level and repeat this step to get the same field strength level as the EUT
- 7) The EIRP level = S.G. output level(dBm)- TX cable(dB) + Substituted Antenna Gain(dBi)
- 8) The ERP level = EIRP-2.15

TEST MODE

Please reference to the section 4.2

TEST RESULTS

Passed Not Applicable

TEST Data

Please refer to appendix A on the appendix report

5.2. 99% Occupied Bandwidth & 26dB Bandwidth

LIMIT

FCC Part 95.573, FCC Part 2.1049

Each FRS transmitter type must be designed such that the occupied bandwidth **does not exceed 12.5 kHz.**

TEST CONFIGURATION

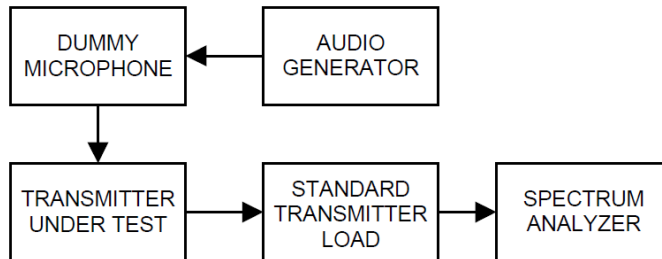

TEST PROCEDURE

- 1) Connect the equipment as illustrated
- 2) Spectrum set as follow:
Centre frequency = the nominal EUT channel center frequency,
The frequency span for the spectrum analyzer shall be set wide enough to capture all modulation products including the emission skirts (typically a span of $1.5 \times \text{OBW}$ is sufficient)
RBW = 1% to 5% of the anticipated OBW, VBW $\geq 3 \times \text{RBW}$, Sweep = auto,
Detector function = peak, Trace = max hold
- 3) Set 99% Occupied Bandwidth and 26dB Bandwidth
- 4) Measure and record the results in the test report.

TEST MODE

Please reference to the section 4.2

TEST RESULTS

Passed Not Applicable

TEST Data

Please refer to appendix B on the appendix report

5.3. Emission Mask

LIMIT

FCC Part 95.579(a)(1)(2)(3), FCC Part 2.1049

Each FRS transmitter type must be designed to satisfy the applicable unwanted emissions limits

- a) Attenuation requirements. The power of unwanted emissions must be attenuated below the carrier power output in Watts (P) by at least:
- (1) 25dB in the frequency band 6.25 kHz to 12.5 kHz removed from the channel center frequency.
 - (2) 35 dB in the frequency band 12.5 kHz to 31.25 kHz removed from the channel center frequency.
 - (3) $43 + 10 \log (P)$ dB in any frequency band removed from the channel center frequency by more than 31.25 kHz.

TEST CONFIGURATION

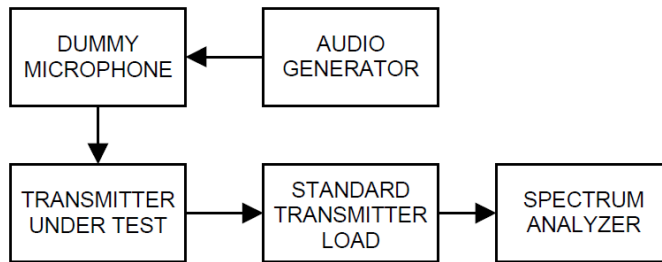

TEST PROCEDURE

- 1) Connect the equipment as illustrated.
- 2) Spectrum set as follow:
Centre frequency = fundamental frequency, RBW=300Hz, VBW=1000Hz, Sweep = auto,
Detector function = peak, Trace = max hold
- 3) Key the transmitter, and set the level of the unmodulated carrier to a full scale reference line.
This is the 0dB reference for the measurement.
- 4) Apply Input Modulation Signal to EUT according to Section 4.2
- 5) Measure and record the results in the test report.

TEST MODE

Please reference to the section 4.2

TEST RESULTS

Passed Not Applicable

TEST Data

Please refer to appendix C on the appendix report

5.4. Modulation Limit

LIMIT

FCC Part 95.575, FCC Part 2.1047(b)

Each FRS transmitter type must be designed such that the peak frequency deviation does **not exceed 2.5kHz**, and the highest audio frequency contributing substantially to modulation must **not exceed 3.125kHz**.

TEST CONFIGURATION

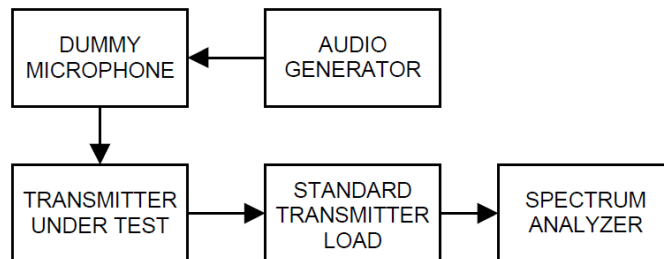

TEST PROCEDURE

- 1) Connect the equipment as illustrated.
- 2) Adjust the transmitter per the manufacturer's procedure for full rated system deviation.
- 3) Set the test receiver to measure peak positive deviation. Set the audio bandwidth for ≤ 0.25 Hz to $\geq 15,000$ Hz. Turn the de-emphasis function off.
- 4) Apply a 1000 Hz modulating signal to the transmitter from the audio frequency generator, and adjust the level to obtain 60% of full rated system deviation.
- 5) Increase the level from the audio frequency generator by 20 dB in one step (rise time between the 10% and 90% points shall be 0.1 second maximum).
- 6) Measure both the instantaneous and steady-state deviation at and after the time of increasing the audio input level
- 7) With the level from the audio frequency generator held constant at the level obtained in step 4), slowly vary the audio frequency from 300 Hz to 3000 Hz and observe the steady-state deviation. Record the maximum deviation.

TEST MODE

Please reference to the section 4.2

TEST RESULTS

Passed Not Applicable

TEST Data

Please refer to appendix D on the appendix report

5.5. Audio Frequency Response

LIMIT

FCC Part 95.575, FCC Part 2.1047(a):

Each FRS transmitter type must be designed such that the peak frequency deviation does **not exceed 2.5kHz**, and the highest audio frequency contributing substantially to modulation must **not exceed 3.125kHz**.

Voice modulated communication equipment. A curve or equivalent data showing the frequency response of the audio modulating circuit over a range of 100 to 5000 Hz shall be submitted.

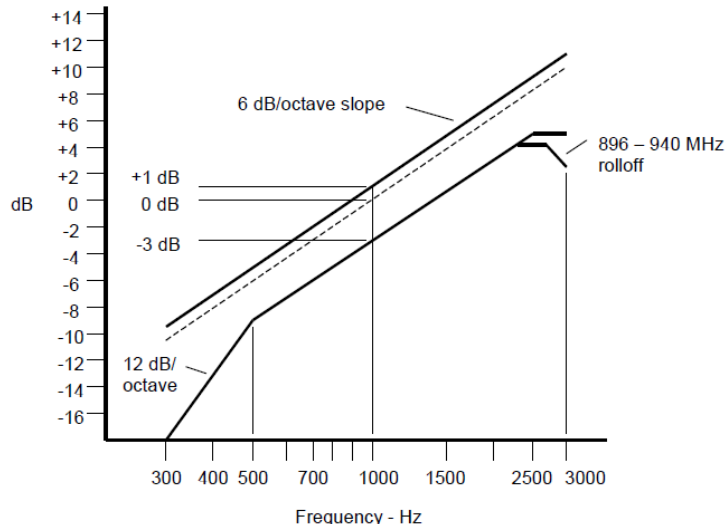

An additional 6 dB per octave attenuation is allowed from 2500 Hz to 3000 Hz in equipment operating in the 25 MHz to 869 MHz range.

TEST CONFIGURATION

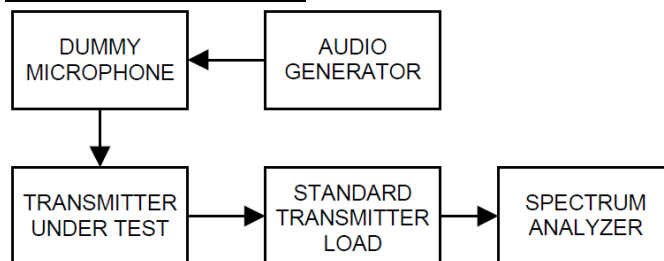

TEST PROCEDURE

- 1) Connect the equipment as illustrated.
- 2) Set the test receiver to measure peak positive deviation. Set the audio bandwidth for 50 Hz to 15,000 Hz. Turn the de-emphasis function off.
- 3) Set the DMM to measure rms voltage.
- 4) Adjust the transmitter per the manufacturer's procedure for full rated system deviation.
- 5) Apply a 1000 Hz tone and adjust the audio frequency generator to produce 20% of the rated system deviation.
- 6) Set the test receiver to measure rms deviation and record the deviation reading.
- 7) Record the DMM reading as V_{REF} .
- 8) Set the audio frequency generator to the desired test frequency between 300 Hz and 3000 Hz.
- 9) Vary the audio frequency generator output level until the deviation reading that was recorded in step 6) is obtained.
- 10) Record the DMM reading as V_{FREQ}
- 11) Calculate the audio frequency response at the present frequency as:
audio frequency response = $20 \log_{10} (V_{FREQ}/V_{REF})$.
- 12) Repeat steps 8) through 11) for all the desired test frequencies

TEST MODE

Please reference to the section 4.2

TEST RESULTS

Passed **Not Applicable**

TEST Data

Please refer to appendix E on the appendix report

5.6. Audio Low Pass Filter Response

LIMIT

FCC Part 95.575), FCC Part 2.1047(a):

The filter must be between the modulation limiter and the modulated stage of the transmitter. At any frequency (f in kHz) between 3 and 20 kHz, the filter must have an attenuation of at least $60 \log_{10}(f/3)$ dB greater than the attenuation at 1 kHz. Above 20 kHz, it must have an attenuation of at least 50 dB greater than the attenuation at 1 kHz.

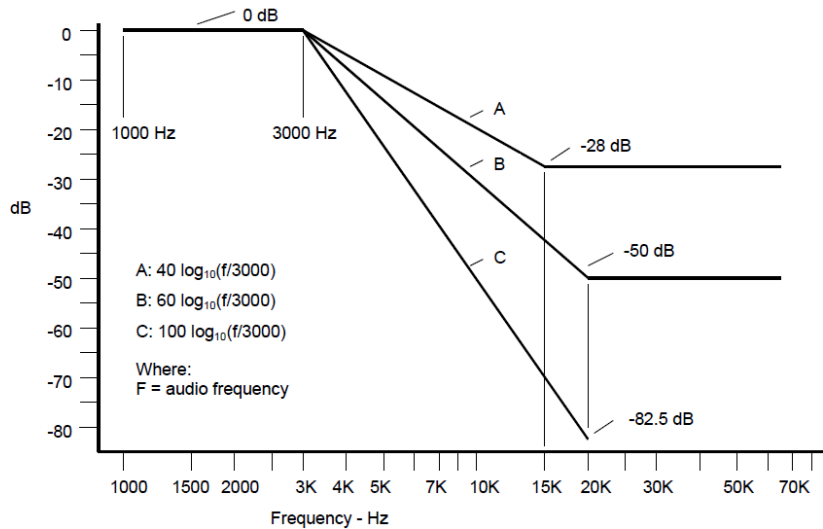

TEST CONFIGURATION

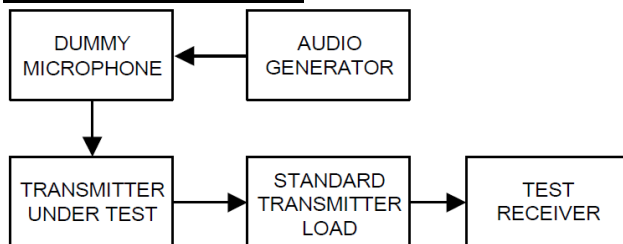

TEST PROCEDURE

- 1) Configure the EUT as shown in figure .
- 2) Apply a 1000 Hz tone from the audio signal generator and adjust the level per manufacturer's specifications. Record the dB level of the 1000 Hz tone as LEV_{REF} .
- 3) Set the audio signal generator to the desired test frequency between 3000 Hz and the upper low pass filter limit. Record the dB level at the test frequency as LEV_{FREQ} .
- 4) Calculate the audio frequency response at the test frequency as:
low pass filter response = $LEV_{FREQ} - LEV_{REF}$

TEST MODE

Please reference to the section 3.4

TEST RESULTS

Passed Not Applicable

Please refer to appendix F on the section 8 appendix report

5.7. Frequency stability VS Temperature

LIMIT

FCC Part 95.565:

Each FRS transmitter type must be designed such that the carrier frequencies remain **within ± 2.5 parts-per-million** of the channel center frequencies specified in §95.563 during normal operating conditions.

TEST CONFIGURATION

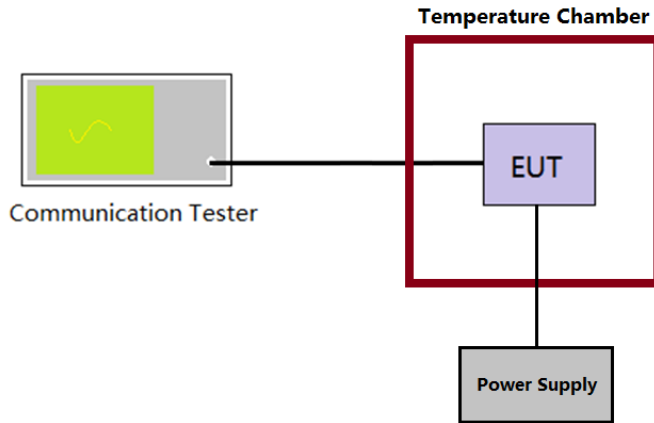

TEST PROCEDURE

- 1) The EUT output port was connected to communication tester.
- 2) The EUT was placed inside the temperature chamber.
- 3) Turn EUT off and set the chamber temperature to -30°C . After the temperature stabilized for approximately 30 minutes recorded the frequency as MCF_{MHz} .
- 4) Calculate the ppm frequency error by the following:

$$\text{ppm error} = (MCF_{\text{MHz}} / ACF_{\text{MHz}} - 1) * 10^6$$
 where
 MCF_{MHz} is the Measured Carrier Frequency in MHz
 ACF_{MHz} is the Assigned Carrier Frequency in MHz
- 5) Repeat step 3 measure with 10°C increased per stage until the highest temperature of $+50^{\circ}\text{C}$ reached.

TEST MODE

Please reference to the section 4.2

TEST RESULTS

Passed Not Applicable

TEST Data

Please refer to appendix G on the appendix report

5.8. Frequency stability VS Voltage

LIMIT

FCC Part 95.565:

Each FRS transmitter type must be designed such that the carrier frequencies remain **within ±2.5 parts-per-million** of the channel center frequencies specified in §95.563 during normal operating conditions.

TEST CONFIGURATION

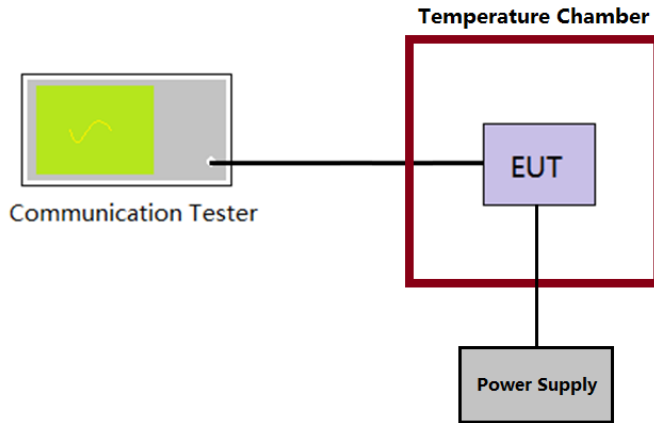

TEST PROCEDURE

- 1) The EUT output port was connected to communication tester.
- 2) The EUT was placed inside the temperature chamber at 25°C
- 3) Record the carrier frequency of the transmitter as MCF_{MHz}
- 4) Calculate the ppm frequency error by the following:
$$ppm\ error = (MCF_{MHz} / ACF_{MHz} - 1) * 10^6$$

where
 MCF_{MHz} is the Measured Carrier Frequency in MHz
 ACF_{MHz} is the Assigned Carrier Frequency in MHz
- 5) Repeat step 3 measure with varied ±15% of the nominal value measured at the input to the EUT

TEST MODE

Please reference to the section 4.2

TEST RESULTS

Passed Not Applicable

TEST Data

Please refer to appendix H on the appendix report

5.9. Transmit Radiated Spurious Emission

LIMIT

FCC Part 95.579(a)(3):

Each FRS transmitter type must be designed to satisfy the applicable unwanted emissions limits

- a) Attenuation requirements. The power of unwanted emissions must be attenuated below the carrier power output in Watts (P) by at least:
- 1) 25dB in the frequency band 6.25 kHz to 12.5 kHz removed from the channel center frequency.
 - 2) 35 dB in the frequency band 12.5 kHz to 31.25 kHz removed from the channel center frequency.
 - 3) $43 + 10 \log(P)$ dB in any frequency band removed from the channel center frequency by more than 31.25 kHz.

Note:

Limit (dBm) = EL - [43 + 10log(P)] = 10log(P * 1000) - [43 + 10log(P)] = 10log(P) + 30 - 43 - 10log(P) = -13dBm

EL is the emission level of the Output Power expressed in dBm,

TEST CONFIGURATION

Below 1GHz:

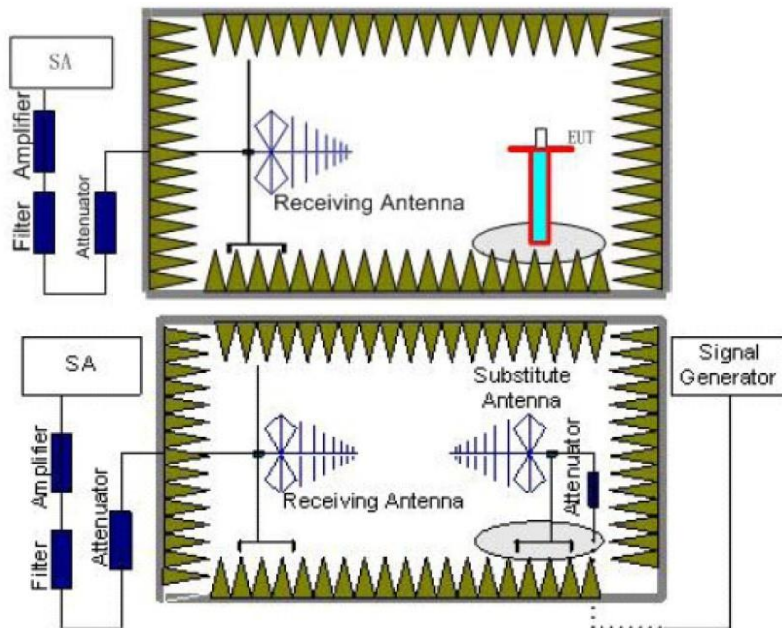

Above 1GHz:

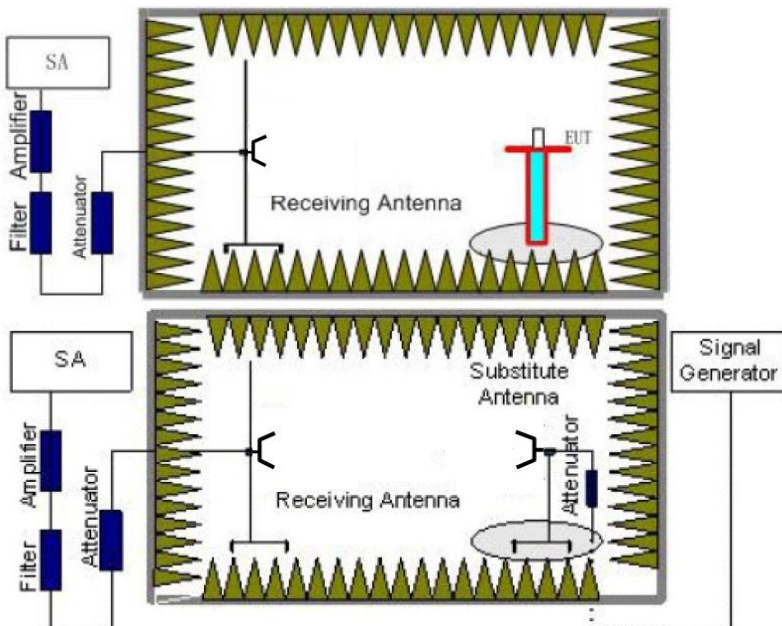

TEST PROCEDURE

- 1) The measuring distance of at 3m shall be used for measurements
- 2) The EUT is placed on a turn table which is 0.8 meter above ground for below 1 GHz, and 1.5 m for above 1 GHz. The table was rotated 360 degrees to determine the position of the highest radiation
- 3) The height of the equipment or of the substitution antenna shall be 0.8 m; the height of the test antenna shall vary between 1 m to 4 m. Both horizontal and vertical polarizations of the antenna are set to make the measurement.
- 4) The spectrum setting as follow
Below 1 GHz: RBW=120kHz, VBW=300kHz, Sweep time=auto, Detector =peak, Trace=max hold;
Above 1GHz: RBW=1MHz, VBW=3MHz Sweep time=auto, Detector=peak, Trace=max hold
- 5) Record the field strength level of the EUT from the spectrum
- 6) The substitution antenna is substituted for EUT at the same position and signals generator (S.G) export the CW signal to the substitution antenna via a TX cable. The receiver antenna shall be moved height from 1m to 4m to find the highest radiation. Adjust the S.G. output level and repeat this step to get the same field strength level as the EUT
- 7) The EIRP level = S.G. output level(dBm)- TX cable(dB) + Substituted Antenna Gain(dBi)
- 8) Record the ERP value for below 1GHz, ERP value = EIRP-2.15; Record the EIRP for above 1GHz.

TEST MODE

Please reference to the section 4.2

TEST RESULTS

Passed **Not Applicable**

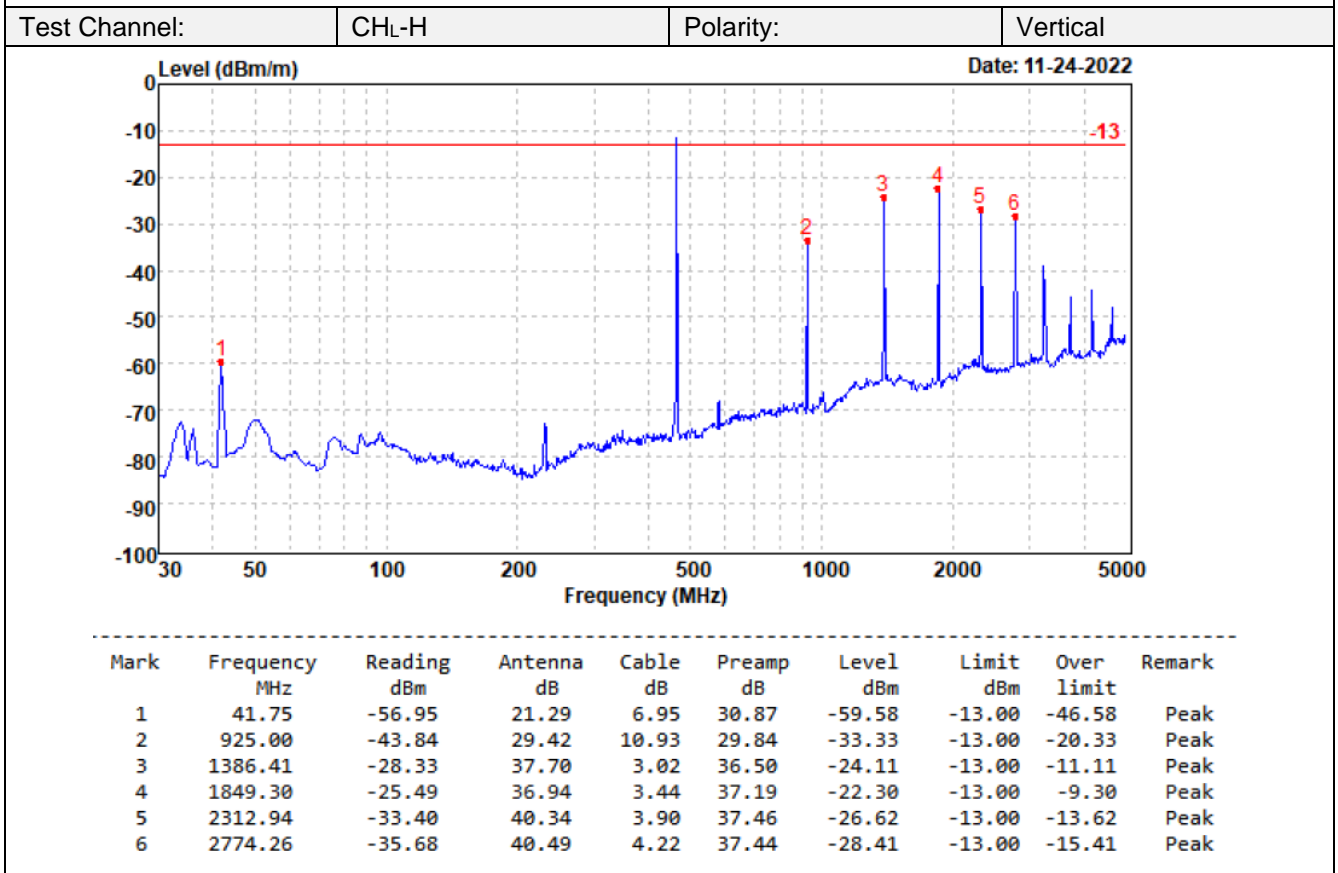
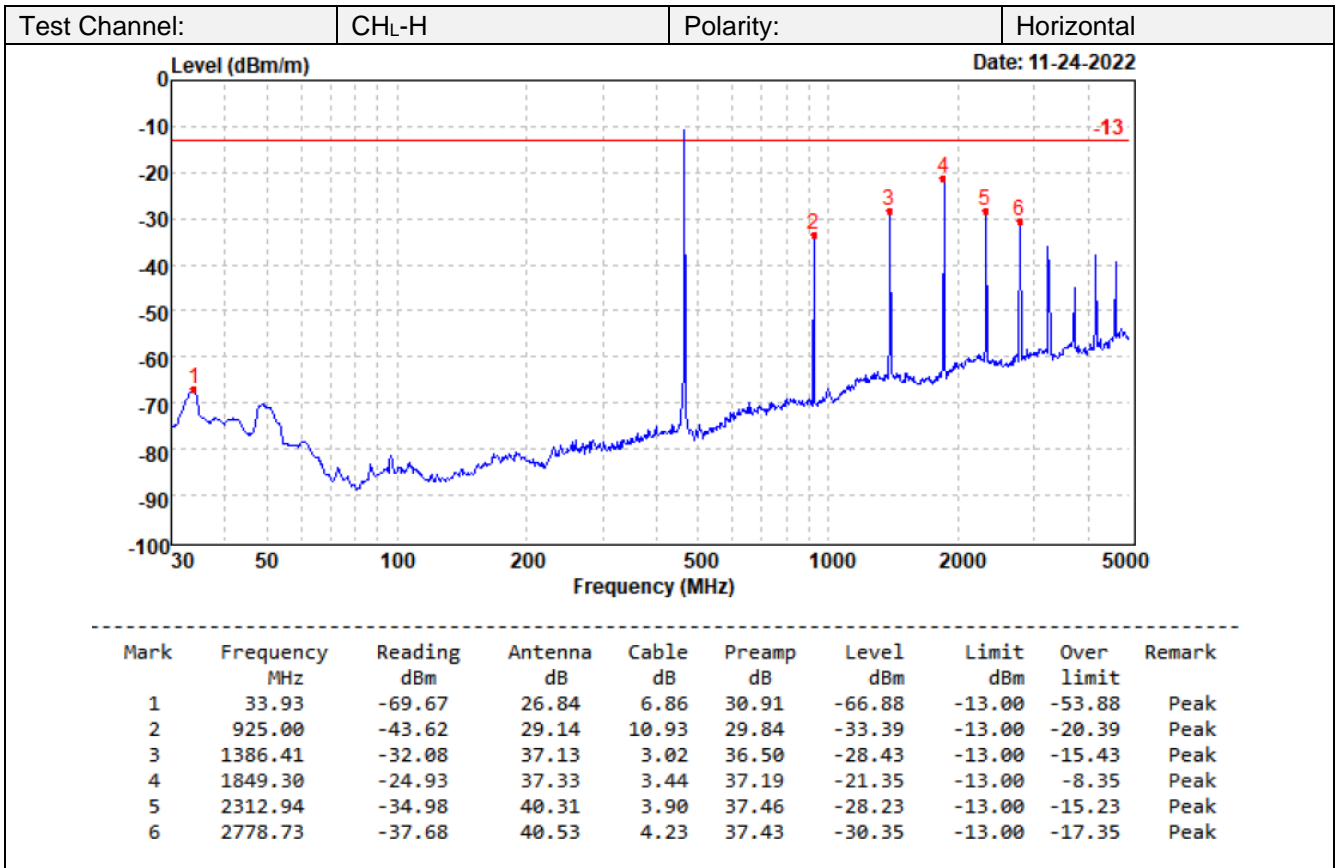

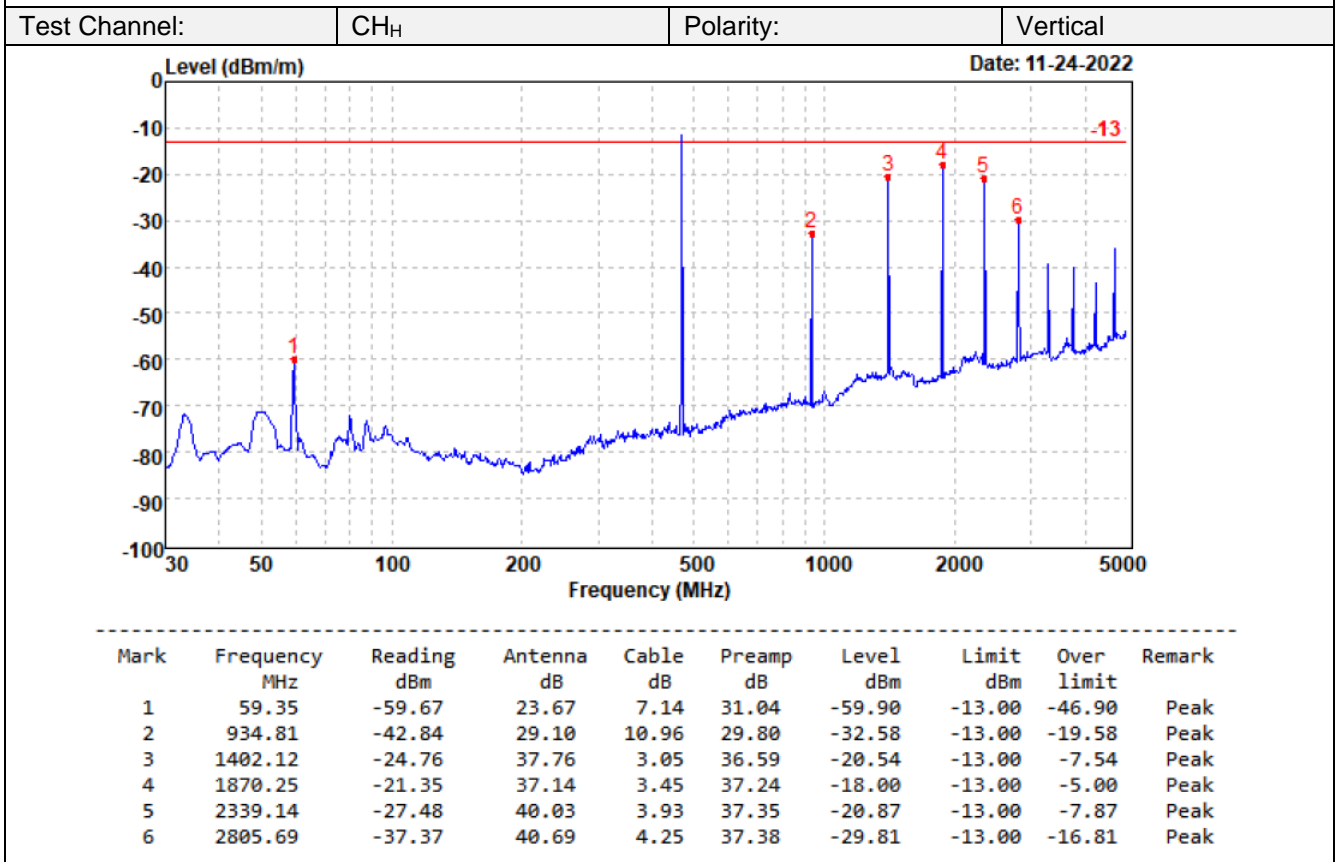
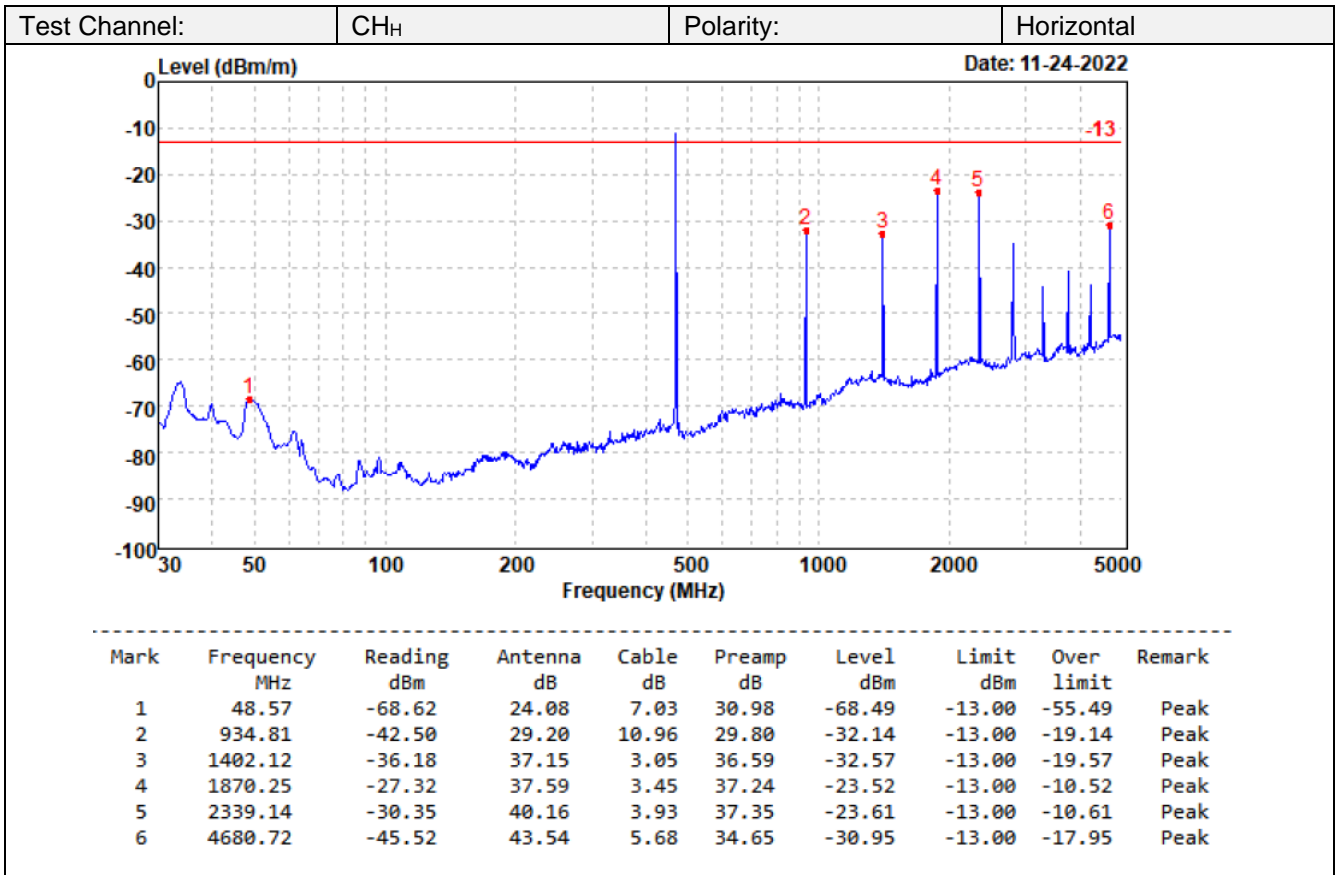

6. TEST SETUP PHOTOS

Radiated Spurious Emission:

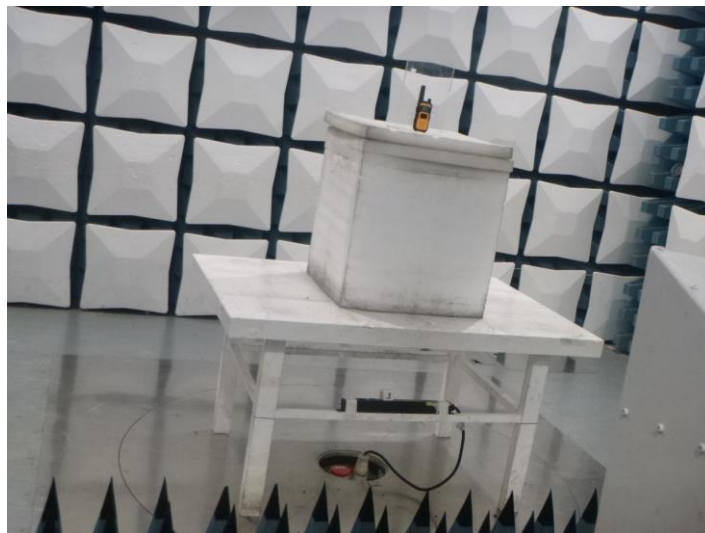

RF Conducted Test Item:



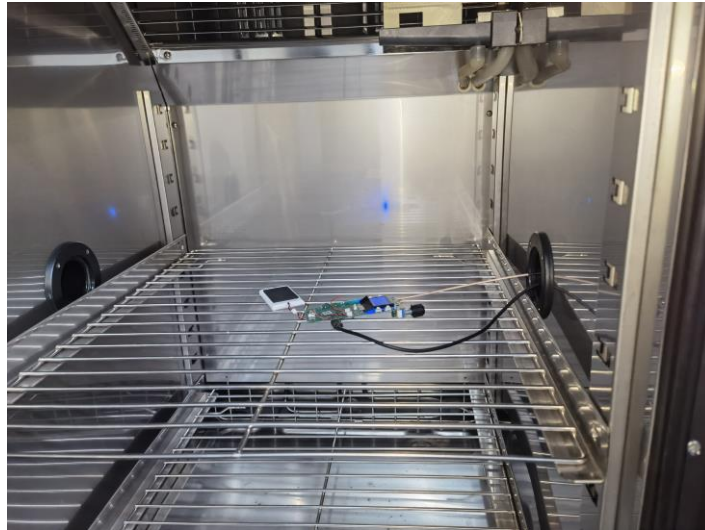

7. EXTERANAL AND INTERNAL PHOTOS

7.1. EXTERANAL PHOTOS



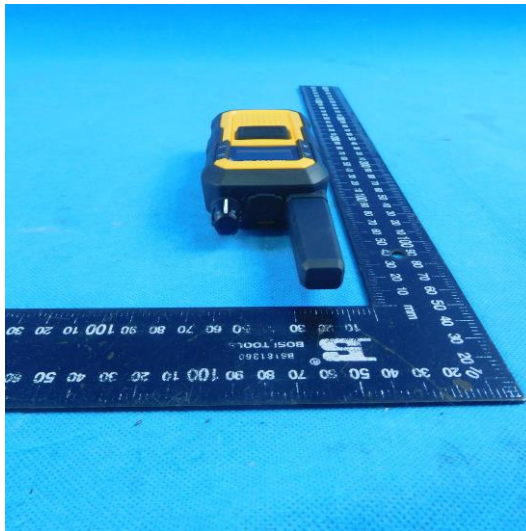
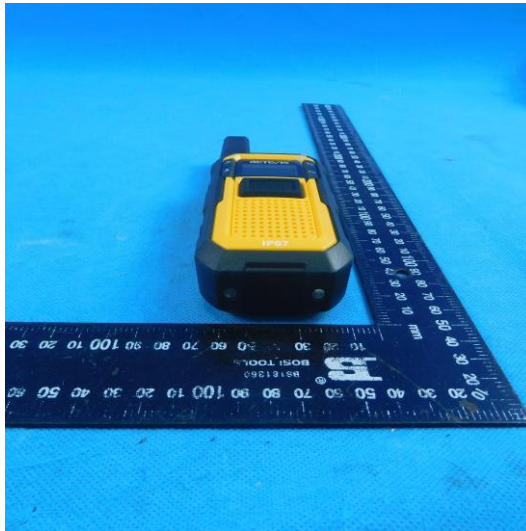



7.2. INTERNAL PHOTOS



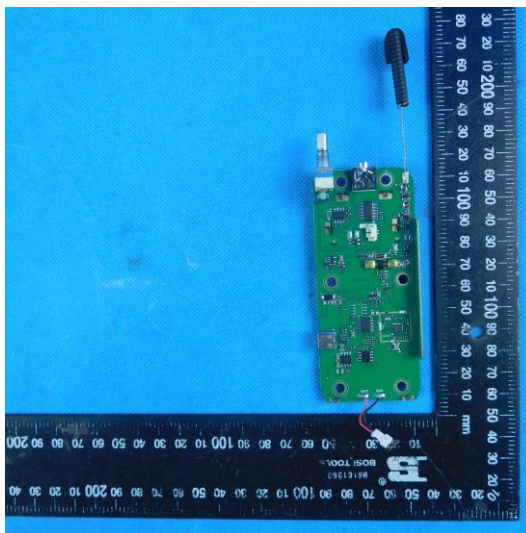
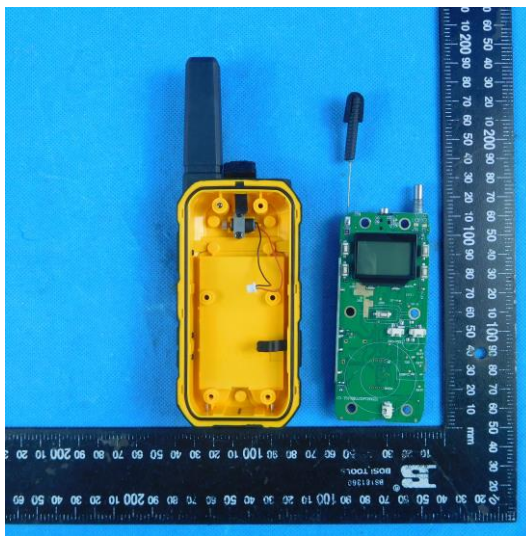

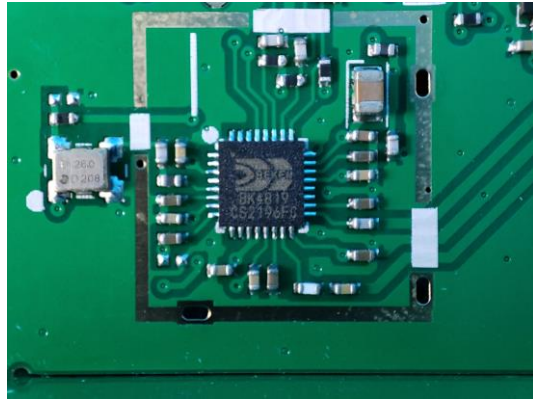

8. APPENDIX REPORT