

RETEVIS

USER'S MANUAL

RB19P Two Way Radio

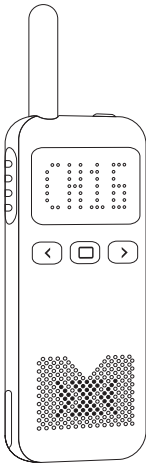

Warning

Please read this manual carefully before using this radio.

- Please do not communicate or charge this radio in flammable, explosive and area which radio communication is prohibited (such as oil station, gas station, airport etc.)
- Please do not operate this radio without license in government laws banned areas.
- Please make sure this radio avoids the sunshine, and avoids to put it near any heating device.
- Please make sure this radio avoids any dusty, humid and water splashed place, and also avoids to put it near any heating device.
- If radio smells or smokes, please remove the battery pack from radio at once, and then please contact your nearest distributor.
- The repair job of this radio is in the charge of professionals & technical's, self-disassembly is prohibited.



WARNING

• MODIFICATION OF THIS DEVICE TO RECEIVE CELLULAR RADIOTELEPHONE SERVICE SIGNALS IS PROHIBITED UNDER FCC RULES AND FEDERAL LAW.

For downloading further resources: Brochures, Software/ Firmware, Manual etc, Pls contact your direct reseller first OR go to website retevis.com and check "support" in the each product link to download it.

◇◇ Standard Accessories



Radio Body

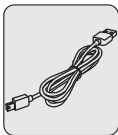

USB Cable

◇◇ Be Familiar With The Machine

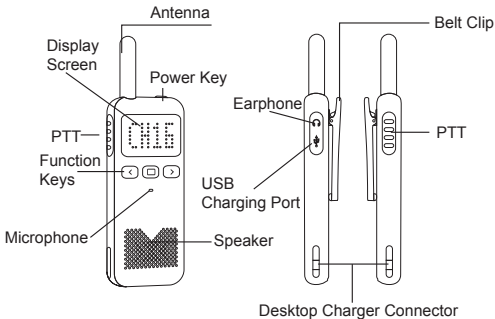

◇◇ Charging the Battery Pack

1. The battery is not charged in the factory, please charge the battery under the environmental temperature 5—40 °C before using.
2. After purchasing or long-term storage (more than two months), charging the battery for the first time can not reach its saturation capacity, repeat charge/discharge for twice or three times to make battery capacity achieve the best state.
3. Before charging, please power off the transceiver, using the transceiver during charging may affect correct charging.
4. If the battery has been charged fully, please do not charge it again, otherwise the service life of the battery may be shorten or may be damaged.
5. If the service time is significantly reduced even after completely correct charging, the battery can not be used any more, please replace a new battery.

◇◇ Icons

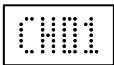

high power channel

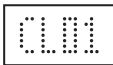

low power channel

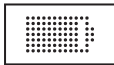

battery level



scanning



channel lockout



unlocking

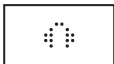

earphone



earphone volume



transmitting

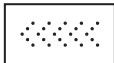

receiving





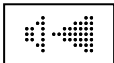

alarm



volume

◇◇ MENU OPERATION



- 1.Short press   keys to adjust the volume.
- 2.Short press  key to switch to channel mode,then short press   keys to adjust the channels.
- 3.PTT: press this button whenever you wish to talk with the user of the other radio.

◇◇ Functions Operation

● Scanning

It is convenient for the user to search for calls from other channels.When“Side Key 2” in the software is programmed to the scanning function,long press  key for two seconds to enter into the scanning mode,the transceiver will start to scan with the current channel;Operate it again to exit.

● Keyboard Lockout

Long press  key to lock  buttons,operate it again to unlock.

● Power Display



Short press  key switch to channel mode, the channel display on the screen flashes, Short press power key to display the current battery level. Press the PTT button or automatically exit after 5 seconds.

● Monitoring

Long press  key for two seconds to enter into the monitor mode,release it to exit.



● NOAA

- 1.Short press power keys to NOAA mode.

2. Short press  key to switch to channel mode, then short press   keys to adjust the channels.
3. Press the PTT button to exit.

- **VOX**

This function can be voice activated so the user doesn't have to press the PTT key.

When "VOX level" in the software is selected, short press  key twice to enter into the VOX mode, then short press  key or  key to turn on/off the VOX.

- **Time Out Timer(TOT)**

The purpose of the TOT is to prevent any single person from using a channel for an extended period of time. An alarm will sound if the transmission continues beyond the set time. The transceiver will stop transmission if this occurs. To stop the alarm, release the PTT key and the transceiver will return to standby.

- **Busy Channel Lockout**

The function can prevent interference from other transceivers using the same channel.

- **High-Low Power**

The transceiver has a high-low power selection, it can be programmed.

- **Battery Power Saving**

If there is no signal or operation, the radio will reduce its power consumption. The battery power-saving function activates when the channel is unoccupied or has not been in operation.

- **Low Battery Warning**

If the battery power falls to the predetermined value during transmission, the transceiver will give out a voice prompt, please charge in time.

- **Companding**

It is a function setting which prevents the inter-channel interference.

● CTCSS/DCS

The transceiver has 50 CTCSS and 208 DCS,also non-standard subaudio can be programmed!

● alarm

When“Side Key 2” in the software is programmed to the alarm function,long press  key for two seconds to enter into the alarm mode,the transceiver will start to alarm with the current channel; press the PTT button to exit.

◇◇ CHANNEL AND FREQUENCIES

GMRS				
channel	TX	RX	Power	subaudio
1	462.5625	462.5625	High	67.0
2	462.5875	462.5875	High	118.8
3	462.6125	462.6125	High	127.3
4	462.6375	462.6375	High	131.8
5	462.6625	462.6625	High	136.5
6	462.6875	462.6875	High	141.3
7	462.7125	462.7125	High	146.2
8	467.5625	467.5625	Low	D243N
9	467.5875	467.5875	Low	D032N
10	467.6125	467.6125	Low	D047N
11	467.6375	467.6375	Low	D051N
12	467.6625	467.6625	Low	D053N

13	467.6875	467.6875	Low	D065N
14	467.7125	467.7125	Low	D116N
15	462.5500	462.5500	High	123
16	462.5750	462.5750	High	D743I
17	462.6000	462.6000	High	D332I
18	462.6250	462.6250	High	127.3
19	462.6500	462.6500	High	D243I
20	462.6750	462.6750	High	D606N
21	462.7000	462.7000	High	D731I
22	462.7250	462.7250	High	136.5
23	467.5500	462.5500	High	136.5
24	467.5750	462.5750	High	136.5
25	467.6000	462.6000	High	136.5
26	467.6250	462.6250	High	136.5
27	467.6500	462.6500	High	136.5
28	467.6750	462.6750	High	136.5
29	467.7000	462.7000	High	136.5
30	467.7250	462.7250	High	136.5

◇◇ Technical Parameters

SPECIFICATIONS	
Frequency Range	GMRS
Supply Power	DC3.7V
Memory Channel	30
Antenna Configuration	Internal Antenna
Work Mode	Co/Differ-frequency Simplex Communication
Ground Method	Cathode
working temperature range	-30°~+60°
TRANSMITTER	
Output Power	≤3W
Modulation Mode	FM(F3E)
Max.Frequency Deviation	≤5KHz
Sparious Radiation	≤7.5μW
Preemphasis Character	Per Octave 6dB
Emission Current	≤1800mA
RECEIVER	
Sensitivity	< 0.16μV(12dB SINAD)
Audio Power	≥300mW
Audio Distortion	< 5%
Itermodulation Interference Resistance	≥60dB
Receiving Current	≤300mA
Standby Current	≤20mA

▲ We May Change The Specifications For Technical Improvement Without Prior Notice.

RF ENERGY EXPOSURE AND PRODUCT SAFETY GUIDE FOR PORTABLE TWO-WAY RADIOS



ATTENTION!

Before using this radio, read this guide which contains important operating instructions for safe usage and rf energy awareness and control for compliance with applicable standards and regulations.

This two-way radio uses electromagnetic energy in the radio frequency (RF) spectrum to provide communications between two or more users over a distance. RF energy, which when used improperly, can cause biological damage.

All Retevis two-way radios are designed, manufactured, and tested to ensure they meet government-established RF exposure levels. In addition, manufacturers also recommend specific operating instructions to users of two-way radios. These instructions are important because they inform users about RF energy exposure and provide simple procedures on how to control it.

Please refer to the following websites for more information on what RF energy exposure is and how to control your exposure to assure compliance with established RF exposure limits:<http://www.who.int/en/>

Local Government Regulations

When two-way radios are used as a consequence of employment, the Local Government Regulations requires users to be fully aware of and able to control their exposure to meet occupational

requirements. Exposure awareness can be facilitated by the use of a product label directing users to specific user awareness information. Your Retevis two-way radio has a RF Exposure Product Label. Also, your Retevis user manual, or separate safety booklet includes information and operating instructions required to control your RF exposure and to satisfy compliance requirements.

Radio License

Governments keep the radios in classification, business two-way radios operate on radio frequencies that are regulated by the local radio management departments (FCC, ISED, OFCOM, ANFR, BFTK, Bundesnetzagentur...). To transmit on these frequencies, you are required to have a license issued by them. The detailed classification and the use of your two radios, please contact the local government radio management departments. Use of this radio outside the country where it was intended to be distributed is subject to government regulations and may be prohibited.

Unauthorized modification and adjustment

Changes or modifications not expressly approved by the party responsible for compliance may void the user's authority granted by the local government radio management departments to operate this radio and should not be made. To comply with the corresponding requirements, transmitter adjustments should be made only by or under the supervision of a person certified as technically qualified to perform transmitter maintenance and repairs in the private land mobile and fixed services as certified by an organization representative of the user of those services. Replacement of any transmitter component (crystal, semiconductor, etc.) not authorized by the local government radio management departments equipment authorization for this radio could violate the rules.

FCC Requirements:

This device complies with part 15 of the FCC Rules. Operation is subject to the condition that this device does not cause harmful interference. (Licensed radios are applicable);

This device complies with part 15 of the FCC Rules. Operation is subject to the following two conditions: (Other devices are applicable)

- (1) This device may not cause harmful interference, and
- (2) this device must accept any interference received, including interference that may cause undesired operation.

NOTE:

•This equipment has been tested and found to comply with the limits for a Class A digital device, pursuant to part 15 of the FCC Rules. These limits are designed to provide reasonable protection against harmful interference when the equipment is operated in a commercial environment. This equipment generates, uses, and can radiate radio frequency energy and, if not installed and used in accordance with the instruction manual, may cause harmful interference to radio communications. Operation of this equipment in a residential area is likely to cause harmful interference in which case the user will be required to correct the interference at his own expense.

•This equipment has been tested and found to comply with the limits for a Class B digital device, pursuant to part 15 of the FCC Rules. These limits are designed to provide reasonable protection against harmful interference in a residential installation. This equipment generates, uses and can radiate radio frequency energy and, if not installed and used in accordance with the instructions, may cause harmful interference to radio communications. However, there is no guarantee that interference will not occur in a particular installation. If this equipment does cause harmful interference to radio or television

reception, which can be determined by turning the equipment off and on, the user is encouraged to try to correct the interference by one or more of the following measures:

- Reorient or relocate the receiving antenna.
- Increase the separation between the equipment and receiver.
- Connect the equipment into an outlet on a circuit different from that to which the receiver is connected.
- Consult the dealer or an experienced radio/TV technician for help.

CE Requirements:

•(Simple EU declaration of conformity) Shenzhen Retevis Technology Co., Ltd. declares that the radio equipment type is in compliance with the essential requirements and other relevant provisions of RED Directive 2014/53/EU and the ROHS Directive 2011/65/EU and the WEEE Directive 2012/19/EU; the full text of the EU declaration of conformity is available at the following internet address: www.retevis.com.

•Restriction Information

This product can be used in EU countries and regions, including: Belgium (BE), Bulgaria (BG), Czech Republic (CZ), Denmark (DK), Germany (DE), Estonia (EE), Ireland (IE), Greece (EL), Spain (ES), France (FR), Croatia (HR), Italy (IT), Cyprus (CY), Latvia (LV), Lithuania (LT), Luxembourg (LU), Hungary (HU), Malta (MT), Netherlands (NL), Austria (AT), Poland (PL), Portugal (PT), Romania (RO), Slovenia (SI), Slovakia (SK), Finland (FI), Sweden (SE) and United Kingdom (UK).

For the warning information of the frequency restriction, please refer to the package or manual section.

•Disposal

The crossed-out wheeled-bin symbol on your product, literature, or packaging reminds you that in the European Union, all electrical and electronic products, batteries, and accumulators

(rechargeable batteries) must be taken to designated collection locations at the end of their working life. Do not dispose of these products as unsorted municipal waste. Dispose of them according to the laws in your area.



IC Requirements:

Licence-exempt radio apparatus

This device contains licence-exempt transmitter(s)/receiver(s) that comply with Innovation, Science and Economic Development Canada's licence-exempt RSS(s). Operation is subject to the following two conditions:

(1) This device must not cause interference.
(2) This device must accept any interference, including interference that may cause undesired operation of the device.
Le présent appareil est conforme aux CNR d' Industrie Canada applicables aux appareils radio exempts de licence. L' exploitation est autorisée aux deux conditions suivantes :

(1) l' appareil ne doit pas produire de brouillage;
(2) l' utilisateur de l' appareil doit accepter tout brouillage radioélectrique subi, même si le brouillage est susceptible d' en compromettre le fonctionnement.

RF Exposure Information

- DO NOT operate the radio without a proper antenna attached, as this may damage the radio and may also cause you to exceed RF exposure limits. A proper antenna is the antenna supplied with this radio by the manufacturer or an antenna specifically authorized by the manufacturer for use with this radio, and the antenna gain shall not exceed the specified gain by the manufacturer declared.
- DO NOT transmit for more than 50% of total radio use time, more than 50% of the time can cause RF exposure compliance requirements to be exceeded.

- During transmissions, your radio generates RF energy that can possibly cause interference with other devices or systems. To avoid such interference, turn off the radio in areas where signs are posted to do so.
- DO NOT operate the transmitter in areas that are sensitive to electromagnetic radiation such as hospitals, aircraft, and blasting sites.
- Portable Device, this transmitter may operate with the antenna(s) documented in this filing in Push-to-Talk and body-worn configurations. RF exposure compliance is limited to the specific belt-clip and accessory configurations as documented in this filing and the separation distance between user and the device or its antenna shall be at least 2.5 cm.
- Mobile Device, during operation, the separation distance between user and the antenna subjects to actual regulations, this separation distance will ensure that there is sufficient distance from a properly installed externally-mounted antenna to satisfy the RF exposure requirements.
- Occupational/Controlled Radio, this radio is designed for and classified as “Occupational/Controlled Use Only”, meaning it must be used only during the course of employment by individuals aware of the hazards, and the ways to minimize such hazards; NOT intended for use in a General population/uncontrolled environment.
- General population/uncontrolled Radio, this radio is designed for and classified as “General population/uncontrolled Use”.

RF Exposure Compliance and Control Guidelines and Operating Instructions

To control your exposure and ensure compliance with the occupational/controlled environment exposure limits, always adhere to the following procedures.

Guidelines:

- User awareness instructions should accompany the device when transferred to other users.
- Do not use this device if the operational requirements described herein are not met.

Operating Instructions:

- Transmit no more than the rated duty factor of 50% of the time. To Transmit (Talk), push the Push to Talk (PTT) button. To receive calls (listen), release the PTT button. Transmitting 50% of the time, or less, is important because the radio generates measurable RF energy exposure only when transmitting in terms of measuring for standards compliance.
- Transmit only when people outside the vehicle are at least the recommended minimum lateral distance away from a properly installed according to installation instructions, externally mounted antenna.
- When operating in front of the face, worn on the body, always place the radio in a Retevis approved clip, holder, holster, case, or body harness for this product. Using approved body-worn accessories is important because the use of Non-Retevis approved accessories may result in exposure levels, which exceed the IEEE/ICNIRP RF exposure limits.

Hand-held Mode

- Hold the radio in a vertical position with the microphone (and other parts of the radio including the antenna) at least 2.5 cm (one inch) away from the nose or lips. The antenna should be kept away from the eyes. Keeping the radio at a proper distance is important as RF exposure decreases with increasing distance from the antenna.



Phone Mode

•When placing or receiving a phone call, hold your radio product as you would a wireless telephone. Speak directly into the microphone.

Electromagnetic Interference/Compatibility

NOTE: Nearly every electronic device is susceptible to electromagnetic interference (EMI) if inadequately shielded, designed, or otherwise configured for electromagnetic compatibility.

Avoid Choking Hazard



Small Parts. Not for children under 3 years.

Turn off your radio power in the following conditions:



- Turn off your radio before removing (installing) a battery or accessory or when charging battery.
- Turn off your radio when you are in a potentially hazardous environments: Near electrical blasting caps, in a blasting area, in explosive atmospheres (inflammable gas, dust particles, metallic powders, grain powders, etc.).
- Turn off your radio while taking on fuel or while parked at gasoline service stations.
To avoid electromagnetic interference and/or compatibility conflicts

- Turn off your radio in any facility where posted notices instruct you to do so, hospitals or health care facilities (Pacemakers, Hearing Aids and Other Medical Devices) may be using equipment that is sensitive to external RF energy.
- Turn off your radio when on board an aircraft. Any use of a radio must be in accordance with applicable regulations per airline crew instructions.

Protect your hearing:



- Use the lowest volume necessary to do your job.
- Turn up the volume only if you are in noisy surroundings.
- Turn down the volume before adding headset or earpiece.
- Limit the amount of time you use headsets or earpieces at high volume.
- When using the radio without a headset or earpiece, do not place the radio's speaker directly against your ear
- Use careful with the earphone maybe possible excessive sound pressure from earphones and headphones can cause hearing loss

Note: Exposure to loud noises from any source for extended periods of time may temporarily or permanently affect your hearing. The louder the radio's volume, the less time is required before your hearing could be affected. Hearing damage from loud noise is sometimes undetectable at first and can have a cumulative effect.

Avoid Burns



Antennas

- Do not use any portable radio that has a damaged antenna. If a damaged antenna comes into contact with the skin when the radio is in use, a minor burn can result.

Batteries (If appropriate)

- When the conductive material such as jewelry, keys or chains touch exposed terminals of the batteries, may complete an electrical circuit (short circuit the battery) and become hot to cause bodily injury such as burns. Exercise care in handling any battery, particularly when placing it inside a pocket, purse or other container with metal objects

Long transmission

- When the transceiver is used for long transmissions, the radiator and chassis will become hot.

Safety Operation



Forbid

- Do not use charger outdoors or in moist environments, use only in dry locations/conditions.
- Do not disassemble the charger, that may result in risk of electrical shock or fire.
- Do not operate the charger if it has been broken or damaged in any way.



- Do not place a portable radio in the area over an air bag or in the air bag deployment area. The radio may be propelled with great force and cause serious injury to occupants of the vehicle when the air bag inflates.

To reduce risk

- Pull by the plug rather than the cord when disconnecting the charger.
- Unplug the charger from the AC outlet before attempting any maintenance or cleaning.
- Contact Retevis for assistance regarding repairs and service.
- The adapter shall be installed near the equipment and shall be easily accessible

Approved Accessories



- This radio meets the RF exposure guidelines when used with the Retevis accessories supplied or designated for the product. Use of other accessories may not ensure compliance with the RF exposure guidelines and may violate regulations.
- For a list of Retevis-approved accessories for your radio model, visit the following website:
<http://www.Retevis.com>

Guarantee

Model Number: _____

Serial Number: _____

Purchasing Date: _____

Dealer: _____ Telephone: _____

User's Name: _____ Telephone: _____

Country: _____ Address: _____

Post Code: _____ Email: _____

Remarks:

1. This guarantee card should be kept by the user, no replacement if lost.
2. Most new products carry a two-year manufacturer's warranty from the date of purchase. Further details, pls read <http://www.retevis.com/after-sale/>
3. The user can get warranty and after-sales service as below:
 - Contact the seller where you buy.
 - Products Repaired by Our Local Repair Center
4. For warranty service, you will need to provide a receipt proof of purchase from the actual seller for verification

Exclusions from Warranty Coverage:

1. To any product damaged by accident.
2. In the event of misuse or abuse of the product or as a result of unauthorized alterations or repairs.
3. If the serial number has been altered, defaced, or removed.

Cut along this line



Shenzhen Ysair Technology Co., LTD

6 / F, building 6, Yunli intelligent park, No. 3, Changfa Middle Road,
Yangmei community, Bantian street, Longgang District, Shenzhen, China

Web: www.retevis.com

E-mail: kam@retevis.com

Facebook: facebook.com/retevis



MADE IN CHINA

说明书要求

尺寸：75*95mm

印刷：
黑白印刷

装订：
骑马钉

纸张材质：
双胶纸

本页无需印刷