



FCC TEST REPORT
FCC ID: 2A30F-NV008SP

Report Number..... : ZHT-230706032E

Date of Test..... July 6, 2023 to July 27, 2023

Date of issue..... : July 27, 2023

Test Result : PASS

Testing Laboratory..... : **Guangdong Zhonghan Testing Technology Co., Ltd.**

Address : Room 104, Building 1, Yibaolai Industrial Park, Qiaotou Community, Fuhai Street, Bao'an District, Shenzhen, Guangdong, China

Applicant's name : **Shenzhen Pard Technology Co.,Ltd**

Address : B78,18/F,Guangyin building,38 Futian South Road, port community, Futian street, Futian District, Shenzhen

Manufacturer's name : **Shenzhen Pard Technology Co.,Ltd**

Address : B78,18/F,Guangyin building,38 Futian South Road, port community, Futian street, Futian District, Shenzhen

Test specification:

Standard..... : FCC CFR Title 47 Part 15 Subpart C Section 15.247

Test procedure..... : KDB558074 D01 15.247 Meas Guidance v05r02
ANSI C63.10:2013

Non-standard test method : N/A

This device described above has been tested by ZHT, and the test results show that the equipment under test (EUT) is in compliance with the FCC requirements. And it is applicable only to the tested sample identified in the report.

This report shall not be reproduced except in full, without the written approval of ZHT, this document may be altered or revised by ZHT, personal only, and shall be noted in the revision of the document.

Product name..... : **Digital Night Vision Camera**

Trademark : PARD

Model/Type reference..... : Please see Section 3.1

Ratings..... : Input: DC 5V 1A or DC 3.7V by battery



Testing procedure and testing location:

Testing Laboratory.....: **Guangdong Zhonghan Testing Technology Co., Ltd.**

Address.....: Room 104, Building 1, Yibaolai Industrial Park, Qiaotou Community, Fuhai Street, Bao'an District, Shenzhen, Guangdong, China

Tested by (name + signature).....: Leon Li

Leon Li

Reviewer (name + signature).....: Baret Wu

Baret Wu

Approved (name + signature).....: Levi Lee





Table of Contents

	Page
1. VERSION	5
2. SUMMARY OF TEST RESULTS	6
2.1 TEST FACILITY	7
2.2 MEASUREMENT UNCERTAINTY	7
3. GENERAL INFORMATION	8
3.1 GENERAL DESCRIPTION OF EUT	8
3.2 DESCRIPTION OF TEST MODES	9
3.3 BLOCK DIGRAM SHOWING THE CONFIGURATION OF SYSTEM TESTED	10
3.4 DESCRIPTION OF SUPPORT UNITS(CONDUCTED MODE)	10
3.5EQUIPMENTS LIST FOR ALL TEST ITEMS	11
4. EMC EMISSION TEST	13
4.1 CONDUCTED EMISSION MEASUREMENT	13
4.1.1 POWER LINE CONDUCTED EMISSION LIMITS	13
4.1.2 TEST PROCEDURE	13
4.1.3 DEVIATION FROM TEST STANDARD	13
4.1.4 TEST SETUP	14
4.1.5 EUT OPERATING CONDITIONS	14
4.2.1 RADIATED EMISSION LIMITS	17
4.2.2 TEST PROCEDURE	17
4.2.3 DEVIATION FROM TEST STANDARD	18
4.2.4 TEST SETUP	18
4.2.5 EUT OPERATING CONDITIONS	19
4.2.6 TEST RESULTS	19
5.RADIATED BAND EMISSIONMEASUREMENT	30
5.1 TEST REQUIREMENT:	30
5.2 TEST PROCEDURE	30
5.3 DEVIATION FROM TEST STANDARD	30
5.4 TEST SETUP	31
5.5 EUT OPERATING CONDITIONS	31
5.6 TEST RESULT	32
6.1 APPLIED PROCEDURES / LIMIT	34
6.2 TEST PROCEDURE	34
6.3 DEVIATION FROM STANDARD	34
6.4 TEST SETUP	34
6.5 EUT OPERATION CONDITIONS	34
6.6 TEST RESULT	35
7. CHANNEL BANDWIDTH& 99% OCCUPY BANDWIDTH	43



7.1 APPLIED PROCEDURES / LIMIT	43
7.2 TEST PROCEDURE	43
7.3 DEVIATION FROM STANDARD	43
7.4 TEST SETUP	43
7.5 EUT OPERATION CONDITIONS	43
7.6 TEST RESULT	44
8. PEAK OUTPUT POWER TEST	47
8.1 APPLIED PROCEDURES/LIMIT	47
8.2 TEST PROCEDURE	47
8.3 DEVIATION FROM STANDARD	47
8.4 TEST SETUP	47
8.5 EUT OPERATION CONDITIONS	47
8.6 TEST RESULT	48
9. CONDUCTED BAND EDGE AND SPURIOUS EMISSION	49
9.1 APPLICABLE STANDARD	49
9.2 TEST PROCEDURE	49
9.3 DEVIATION FROM STANDARD	49
9.4 TEST SETUP	49
9.5 EUT OPERATION CONDITIONS	49
9.6 TEST RESULTS	49
10. ANTENNA REQUIREMENT	54
11. TEST SETUP PHOTO	55
12. EUT CONSTRUCTIONAL DETAILS	55



1. VERSION

Report No.	Version	Description	Approved
ZHT-230706032E	Rev.01	Initial issue of report	July 27, 2023



2. SUMMARY OF TEST RESULTS

Test procedures according to the technical standards:

FCC Part15 (15.247) , Subpart C			
Standard Section	Test Item	Result	Remark
FCC part 15.203/15.247 (b)(4)	Antenna requirement	PASS	
FCC part 15.207	AC Power Line Conducted Emission	PASS	
FCC part 15.247 (b)(3)	Conducted Peak Output Power	PASS	
FCC part 15.247 (a)(2)	Channel Bandwidth& 99% OCB	PASS	
FCC part 15.247 (e)	Power Spectral Density	PASS	
FCC part 15.247(d)	Band Edge	PASS	
FCC part 15.205/15.209	Spurious Emission	PASS	

NOTE:

(1) "N/A" denotes test is not applicable in this Test Report



2.1 TEST FACILITY

Guangdong Zhonghan Testing Technology Co., Ltd.

Add. : Room 104, Building 1, Yibaolai Industrial Park, Qiaotou Community, Fuhai Street, Bao'an District Shenzhen, Guangdong, China

FCC Registration Number:255941

Designation Number: CN0325

IC Registered No.: 29832

CAB identifier: CN0143

2.2 MEASUREMENT UNCERTAINTY

The reported uncertainty of measurement $y \pm U$ · where expanded uncertainty U is based on a standard uncertainty multiplied by a coverage factor of $k=2$ · providing a level of confidence of approximately 95 % ·

No.	Item	Uncertainty
1	Conducted Emission Test	$\pm 1.38\text{dB}$
2	RF power conducted	$\pm 0.16\text{dB}$
3	Spurious emissions conducted	$\pm 0.21\text{dB}$
4	All emissions radiated(9k-30MHz)	$\pm 4.68\text{dB}$
5	All emissions radiated(<1G)	$\pm 4.68\text{dB}$
6	All emissions radiated(>1G)	$\pm 4.89\text{dB}$
7	Temperature	$\pm 0.5^\circ\text{C}$
8	Humidity	$\pm 2\%$
9	Occupied Bandwidth	$\pm 4.96\text{dB}$



3. GENERAL INFORMATION

3.1 GENERAL DESCRIPTION OF EUT

Product Name:	Digital Night Vision Camera
Model No.:	NV008SP NV008SP-LRF, NV008SP2, NV008SP2-LRF, NV008X, NV008X-LRF, NV008XP, NV008XP-LRF, NV008Pro, NV008Pro-LRF
Model Different:	All the model are of the same circuit and RF module, and the only difference are brand and packaging. The model NV008SP is the tested sample.
Hardware Version:	V1.0
Software Version:	V1.0
Sample(s) Status:	Engineer sample
Channel numbers:	802.11b/802.11g /802.11n(HT20):11/ 802.11n(HT40):7
Operation Frequency:	802.11b/802.11g /802.11n(HT20): 2412-2462MHz 802.11n(HT40): 2422-2452MHz
Channel separation:	5MHz
Modulation technology:	IEEE 802.11b: DSSS (CCK, DQPSK, DBPSK) IEEE 802.11g: OFDM (64QAM, 16QAM, QPSK, BPSK) IEEE 802.11n: OFDM (64QAM, 16QAM, QPSK, BPSK)
SU mode:	Single User mode
Antenna Type:	FPC Antenna
Antenna gain:	1.5 dBi
Power supply:	Input: 5V 1A or DC 3.7V by battery



Operation Frequency each of channel							
Channel	Frequency	Channel	Frequency	Channel	Frequency	Channel	Frequency
1	2412MHz	4	2427MHz	7	2442MHz	10	2457MHz
2	2417MHz	5	2432MHz	8	2447MHz	11	2462MHz
3	2422MHz	6	2437MHz	9	2452MHz	X	

Note:

In section 15.31(m), regards to the operating frequency range over 10 MHz, the Lowest frequency, the middle frequency, and the highest frequency of channel were selected to perform the test, and the selected channel see below:

Test channel	Frequency (MHz)	
	802.11b/802.11g/802.11n(HT20)	802.11n(HT40)/
Lowest channel	2412MHz	2422MHz
Middle channel	2437MHz	2437MHz
Highest channel	2462MHz	2452MHz

3.2 DESCRIPTION OF TEST MODES

Transmitting mode	Keep the EUT in continuously transmitting mode
Remark: EUT use new battery during the test, the duty cycle >98%, the test voltage was tuned from 85% to 115% of the nominal rated supply voltage, and found that the worst case was under the nominal rated supply condition. So the report just shows that condition's data.	

We have verified the construction and function in typical operation. All the test modes were carried out with the EUT in transmitting operation, which was shown in this test report and defined as follows:				
Pre-scan all kind of data rate in lowest channel, and found the follow list which it was worst case.				
Mode	802.11b	802.11g	802.11n (HT20)	802.11n (HT40)
Data rate	1Mbps	6Mbps	6.5Mbps	13Mbps



3.3 BLOCK DIGRAM SHOWING THE CONFIGURATION OF SYSTEM TESTED

Radiated Emission

EUT

Conducted Spurious

EUT

3.4 DESCRIPTION OF SUPPORT UNITS(CONDUCTED MODE)

The EUT has been tested as an independent unit together with other necessary accessories or support units. The following support units or accessories were used to form a representative test configuration during the tests.

Item	Equipment	Mfr/Brand	Model/Type No.	Series No.	Note
E-1	Digital Night Vision Camera	N/A	NV008SP	N/A	EUT

Item	Shielded Type	Ferrite Core	Length	Note

Note:

- (1) The support equipment was authorized by Declaration of Confirmation.
- (2) For detachable type I/O cable should be specified the length in cm in 『Length』 column.



3.5EQUIPMENTS LIST FOR ALL TEST ITEMS

Radiation Test equipment

Item	Equipment	Manufacturer	Model	Last Cal.	Next Cal.
1	Receiver	R&S	ESCI	Mar 12, 2023	Mar 11, 2024
2	Loop antenna	EMCI	LAP600	Mar 12, 2023	Mar 11, 2024
3	Amplifier	Schwarzbeck	BBV 9743 B	Mar 12, 2023	Mar 11, 2024
4	Amplifier	Schwarzbeck	BBV 9718 B	Mar 12, 2023	Mar 11, 2024
5	Bilog Antenna	Schwarzbeck	VULB9162	Mar 17, 2023	Mar 16, 2024
6	Horn Antenna	Schwarzbeck	BBHA9120D	Mar 17, 2023	Mar 16, 2024
7	Horn Antenna	A.H.SYSTEMS	SAS574	Mar 12, 2023	Mar 11, 2024
8	Amplifier	AEROFLEX	100KHz-40GHz	Mar 12, 2023	Mar 11, 2024
9	Spectrum Analyzer	R&S	FSV40	Mar 12, 2023	Mar 11, 2024
10	CDNE	Schwarzbeck	CDNE M2 + CDNE M3	Aug. 09, 2022	Aug. 08, 2023
11	966 Anechoic Chamber	EMToni	9m6m6m	Nov. 25, 2021	Nov. 24, 2024
12	Spectrum Analyzer	KEYSIGHT	N9020A	Mar 12, 2023	Mar 11, 2024
13	WIDBAND RADIO COMMUNICATION TESTER	R&S	CMW500	Mar 12, 2023	Mar 11, 2024
14	Single Generator	Agilent	N5182A	Mar 12, 2023	Mar 11, 2024
15	Power Sensor	MWRftest	MW100-RFCB	Mar 12, 2023	Mar 11, 2024
16	Audio analyzer	R&S	UPL	Mar 12, 2023	Mar 11, 2024
17	Single Generator	R&S	SMB100A	Mar 12, 2023	Mar 11, 2024
18	Power Amplifier Shielding Room	EMToni	2m3m3m	Nov. 25, 2021	Nov. 24, 2024



Conduction Test equipment

Equipment	Manufacturer	Model	Last Cal.	Next Cal.
Receiver	R&S	ESCI	Mar 12, 2023	Mar 11, 2024
LISN	R&S	ENV216	Mar 12, 2023	Mar 11, 2024
ISN CAT 6	Schwarzbeck	NTFM 8158	Mar 12, 2023	Mar 11, 2024
ISN CAT 5	Schwarzbeck	CAT5 8158	Mar 12, 2023	Mar 11, 2024
Capacitive Voltage Probe	Schwarzbeck	CVP 9222 C	Mar 12, 2023	Mar 11, 2024
Current Transformer Clamp	Schwarzbeck	SW 9605	Mar 12, 2023	Mar 11, 2024
CE Shielding Room	EMToni	9m4m3m	Nov. 25, 2021	Nov. 24, 2024



4. EMC EMISSION TEST

4.1 CONDUCTED EMISSION MEASUREMENT

Test Requirement:	FCC Part15 C Section 15.207
Test Method:	ANSI C63.10:2013
Test Frequency Range:	150KHz to 30MHz
Receiver setup:	RBW=9KHz, VBW=30KHz, Sweep time=auto

4.1.1 POWER LINE CONDUCTED EMISSION Limits

FREQUENCY (MHz)	Limit (dBuV)		Standard
	Quasi-peak	Average	
0.15 -0.5	66 - 56 *	56 - 46 *	FCC
0.50 -5.0	56.00	46.00	FCC
5.0 -30.0	60.00	50.00	FCC

Note:

(1) *Decreases with the logarithm of the frequency.

4.1.2 TEST PROCEDURE

- a. The EUT was placed 0.8 meters from the horizontal ground plane with EUT being connected to the power mains through a line impedance stabilization network (LISN). All other support equipments powered from additional LISN(s). The LISN provide 50 Ohm/ 50uH of coupling impedance for the measuring instrument.
- b. Interconnecting cables that hang closer than 40 cm to the ground plane shall be folded back and forth in the center forming a bundle 30 to 40 cm long.
- c. I/O cables that are not connected to a peripheral shall be bundled in the center. The end of the cable may be terminated, if required, using the correct terminating impedance. The overall length shall not exceed 1 m.
- d. LISN at least 80 cm from nearest part of EUT chassis.
- e. For the actual test configuration, please refer to the related Item –EUT Test Photos.

4.1.3 DEVIATION FROM TEST STANDARD

No deviation

4.1.4 TEST SETUP

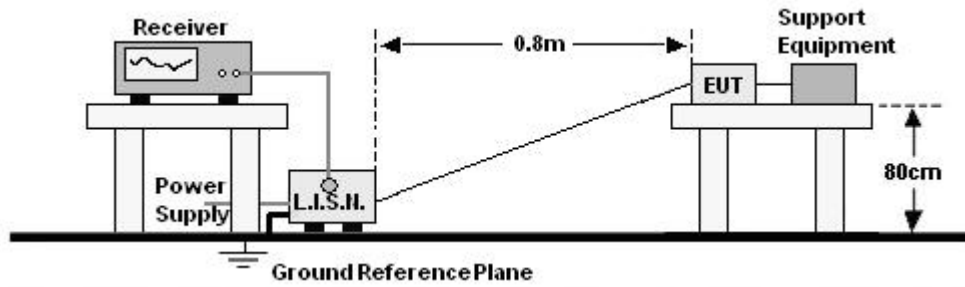

4.1.5 EUT OPERATING CONDITIONS

The EUT was configured for testing in a typical fashion (as a customer would normally use it). The EUT has been programmed to continuously transmit during test. This operating condition was tested and used to collect the included data.



4.1.6 test result

Temperature :	25.1°C	Relative Humidity :	54%
Pressure :	101kPa	Phase :	Live
Test Voltage :	AC 120V/60Hz		

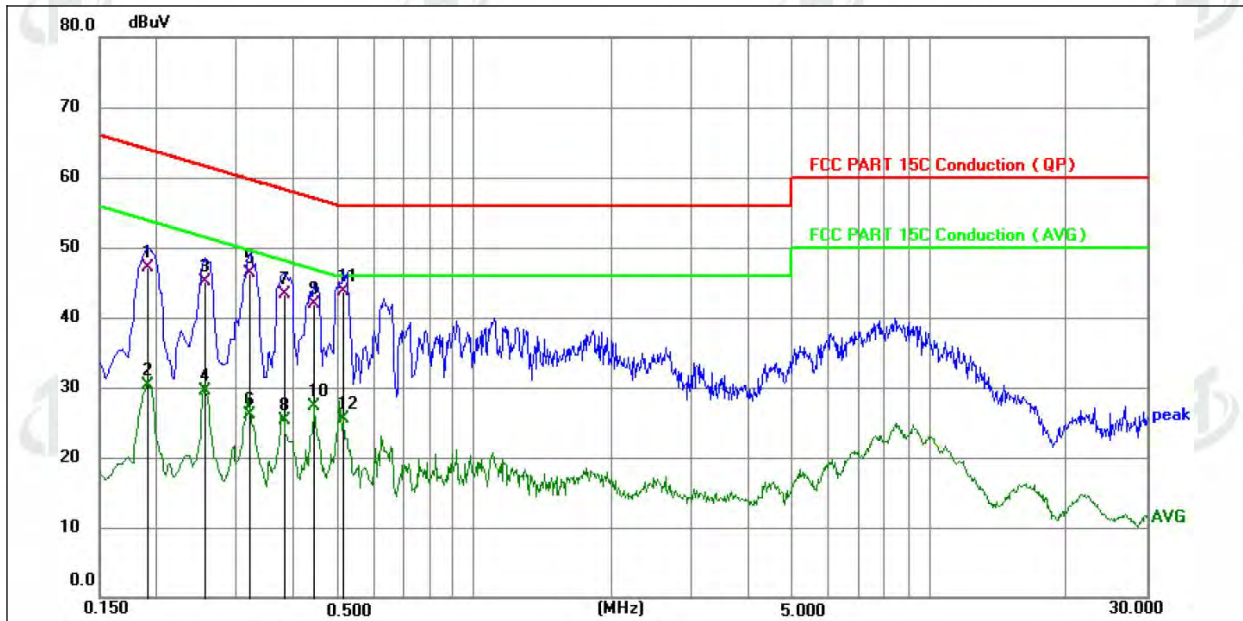

No.	Frequency (MHz)	Reading (dBuV)	Factor (dB)	Level (dBuV)	Limit (dBuV)	Margin (dB)	Detector	P/F
1	0.1905	37.17	9.91	47.08	64.01	-16.93	QP	P
2	0.1905	20.33	9.91	30.24	54.01	-23.77	AVG	P
3	0.2561	35.27	9.93	45.20	61.56	-16.36	QP	P
4	0.2561	19.50	9.93	29.43	51.56	-22.13	AVG	P
5	0.3209	36.29	9.96	46.25	59.68	-13.43	QP	P
6	0.3209	16.10	9.96	26.06	49.68	-23.62	AVG	P
7	0.3795	33.34	9.98	43.32	58.29	-14.97	QP	P
8	0.3795	15.26	9.98	25.24	48.29	-23.05	AVG	P
9	0.4425	31.85	10.00	41.85	57.01	-15.16	QP	P
10	0.4425	17.31	10.00	27.31	47.01	-19.70	AVG	P
11 *	0.5144	33.60	10.02	43.62	56.00	-12.38	QP	P
12	0.5144	15.47	10.02	25.49	46.00	-20.51	AVG	P



Temperature :	25.1°C	Relative Humidity :	54%
Pressure :	101kPa	Phase :	Neutral
Test Voltage :	AC 120V/60Hz		

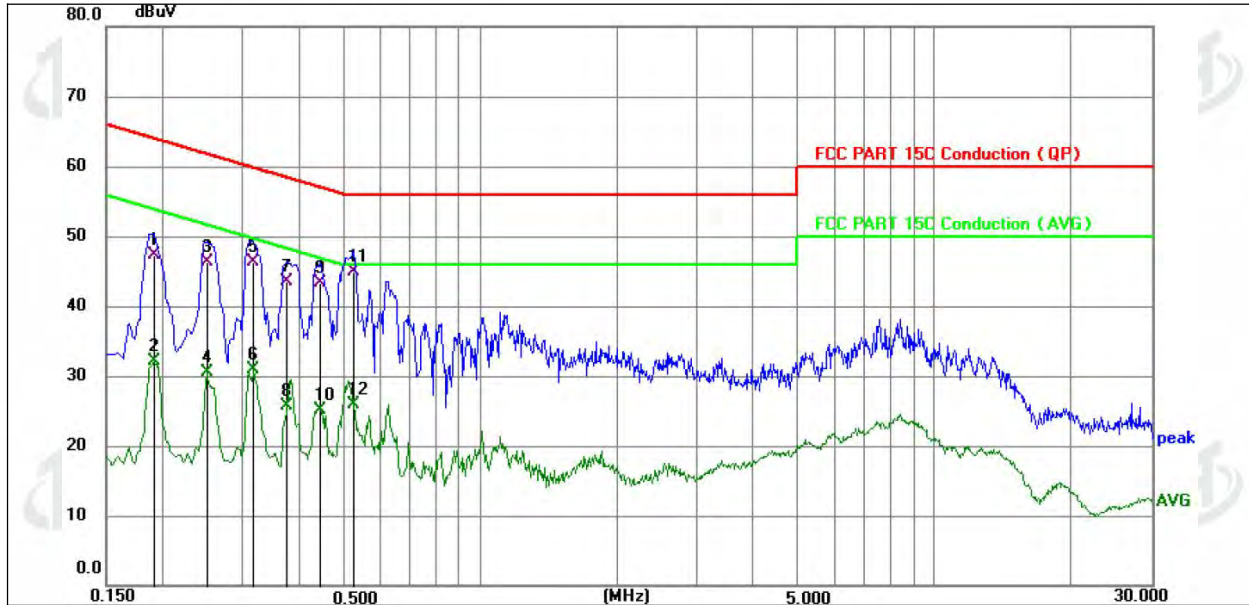

No.	Frequency (MHz)	Reading (dBuV)	Factor (dB)	Level (dBuV)	Limit (dBuV)	Margin (dB)	Detector	P/F
1	0.1905	37.35	9.91	47.26	64.01	-16.75	QP	P
2	0.1905	22.10	9.91	32.01	54.01	-22.00	AVG	P
3	0.2490	36.30	9.93	46.23	61.79	-15.56	QP	P
4	0.2490	20.64	9.93	30.57	51.79	-21.22	AVG	P
5	0.3165	36.27	9.96	46.23	59.80	-13.57	QP	P
6	0.3165	20.88	9.96	30.84	49.80	-18.96	AVG	P
7	0.3750	33.54	9.98	43.52	58.39	-14.87	QP	P
8	0.3750	15.67	9.98	25.65	48.39	-22.74	AVG	P
9	0.4425	33.29	10.00	43.29	57.01	-13.72	QP	P
10	0.4425	15.18	10.00	25.18	47.01	-21.83	AVG	P
11 *	0.5234	34.83	10.02	44.85	56.00	-11.15	QP	P
12	0.5234	15.93	10.02	25.95	46.00	-20.05	AVG	P



4.2 RADIATED EMISSION MEASUREMENT

Test Requirement:	FCC Part15 C Section 15.209				
Test Method:	ANSI C63.10:2013				
Test Frequency Range:	9kHz to 25GHz				
Test site:	Measurement Distance: 3m				
Receiver setup:	Frequency	Detector	RBW	VBW	Value
	9KHz-150KHz	Quasi-peak	200Hz	600Hz	Quasi-peak
	150KHz-30MHz	Quasi-peak	9KHz	30KHz	Quasi-peak
	30MHz-1GHz	Quasi-peak	100KHz	300KHz	Quasi-peak
	Above 1GHz	Peak	1MHz	3MHz	Peak
Peak		1MHz	10Hz	Average	

4.2.1 RADIATED EMISSION LIMITS

Frequencies (MHz)	Field Strength (micorvolts/meter)	Measurement Distance (meters)
0.009~0.490	2400/F(KHz)	300
0.490~1.705	24000/F(KHz)	30
1.705~30.0	30	30
30~88	100	3
88~216	150	3
216~960	200	3
Above 960	500	3

LIMITS OF RADIATED EMISSION MEASUREMENT

FREQUENCY (MHz)	Limit (dBuV/m) (at 3M)	
	PEAK	AVERAGE
Above 1000	74	54

Notes:

- (1) The limit for radiated test was performed according to FCC PART 15C.
- (2) The tighter limit applies at the band edges.
- (3) Emission level (dBuV/m)=20log Emission level (uV/m).

4.2.2 TEST PROCEDURE

Below 1GHz test procedure as below:

- a. The EUT was placed on the top of a rotating table 0.8 meters above the ground at a 3 meter semi-anechoiccamber. The table was rotated 360 degrees to determine the position of the highest radiation.
- b. The EUT was set 3 meters away from the interference-receiving antenna, which was mounted on the top of variable-height antenna tower.

- c. The antenna height is varied from one meter to four meters above the ground to determine the maximum value of the field strength. Both horizontal and vertical polarizations of the antenna are set to make the measurement.
- d. For each suspected emission, the EUT was arranged to its worst case and then the antenna was tuned to heights from 1 meter to 4 meters (for the test frequency of below 30MHz, the antenna was tuned to heights 1meter) and the rotatable table was turned from 0 degrees to 360 degrees to find the maximum reading.
- e. The test-receiver system was set to Peak Detect Function and Specified Bandwidth with Maximum Hold Mode.
- f. If the emission level of the EUT in peak mode was 10dB lower than the limit specified, then testing could be stopped and the peak values of the EUT would be reported. Otherwise the emissions that did not have 10dBmargin would be re-tested one by one using peak, quasi-peak or average method as specified and then reported in a data sheet.

Above 1GHz test procedure as below:

- g. Different between above is the test site, change from Semi- Anechoic Chamber to fully Anechoic Chamber and change form table 0.8 meter to 1.5 meter(Above 18GHz the distance is 1 meter and table is 1.5 meter).
- h. Test the EUT in the lowest channel ,the middle channel ,the Highest channel

Note:

Both horizontal and vertical antenna polarities were tested and performed pretest to three orthogonal axis. The worst case emissions were reported

4.2.3 DEVIATION FROM TEST STANDARD

No deviation

4.2.4 TEST SETUP

(A) Radiated Emission Test-Up Frequency Below 30MHz

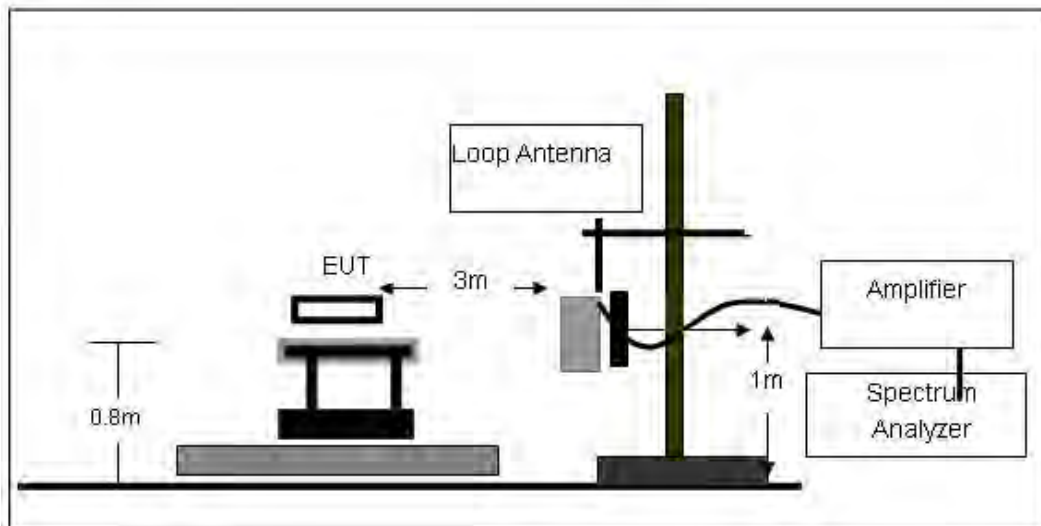

(B) Radiated Emission Test-Up Frequency 30MHz~1GHz

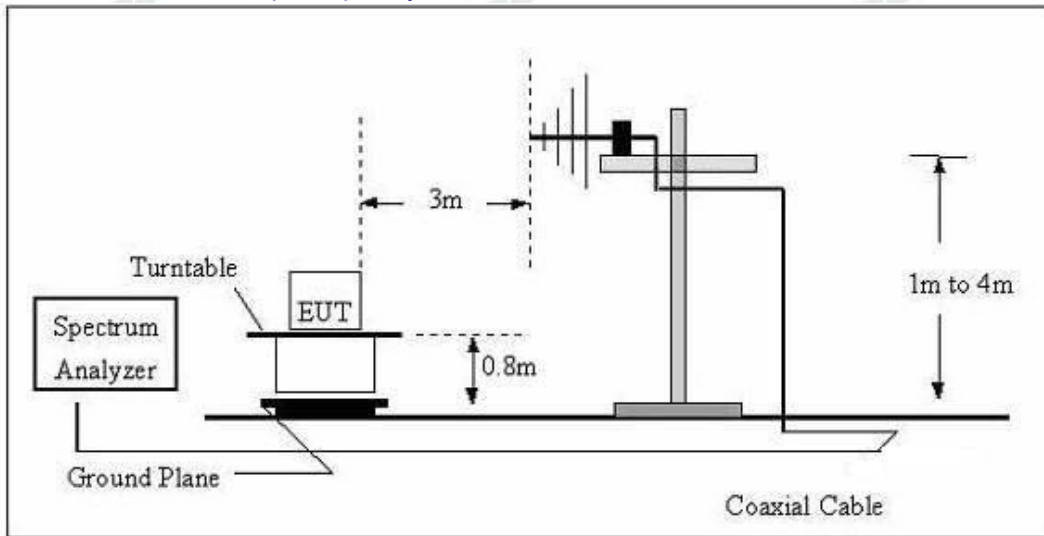

(C) Radiated Emission Test-Up Frequency Above 1GHz

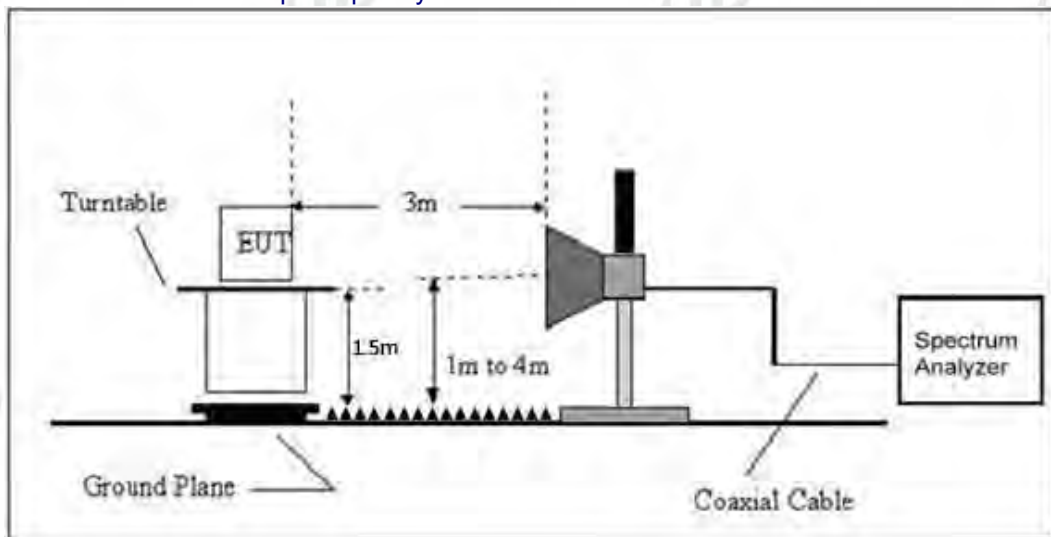

4.2.5 EUT OPERATING CONDITIONS

The EUT tested system was configured as the statements of 2.4 Unless otherwise a special operating condition is specified in the follows during the testing.

4.2.6 TEST RESULTS

Between 9KHz – 30MHz

The emission from 9 kHz to 30MHz was pre-tested and found the result was 20dB lower than the limit, and according to 15.31(o) & RSS-Gen 6.13, the test result no need to reported.



Between 30MHz – 1GHz

Temperature :	25.1°C	Relative Humidity :	50%
Pressure :	101kPa	Polarization :	Horizontal
Test Voltage :	AC 120V/60Hz		

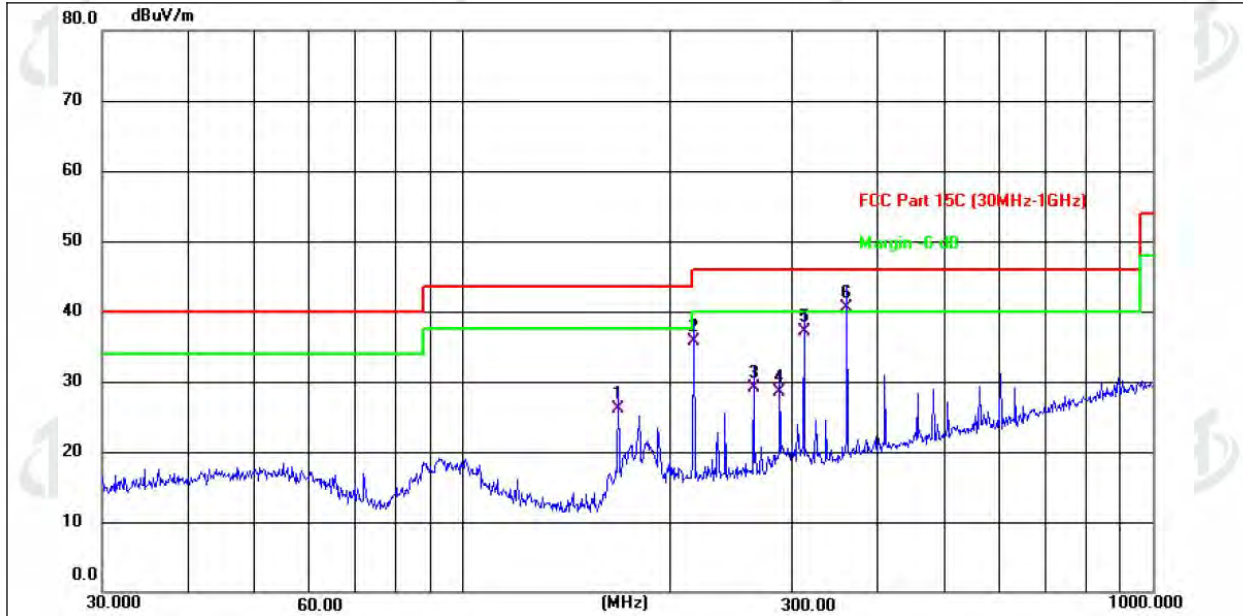

No.	Frequency (MHz)	Reading (dBuV)	Factor (dB/m)	Level (dBuV/m)	Limit (dBuV/m)	Margin (dB)	Detector
1	167.8240	38.90	-12.79	26.11	43.50	-17.39	QP
2	216.0240	45.52	-9.90	35.62	46.00	-10.38	QP
3	263.8190	37.64	-8.55	29.09	46.00	-16.91	QP
4	287.9904	36.61	-8.01	28.60	46.00	-17.40	QP
5	312.1794	44.64	-7.51	37.13	46.00	-8.87	QP
6 *	360.4476	47.04	-6.60	40.44	46.00	-5.56	QP



Temperature :	25.1℃	Relative Humidity :	50%
Pressure :	101kPa	Polarization :	Vertical
Test Voltage :	AC 120V/60Hz		

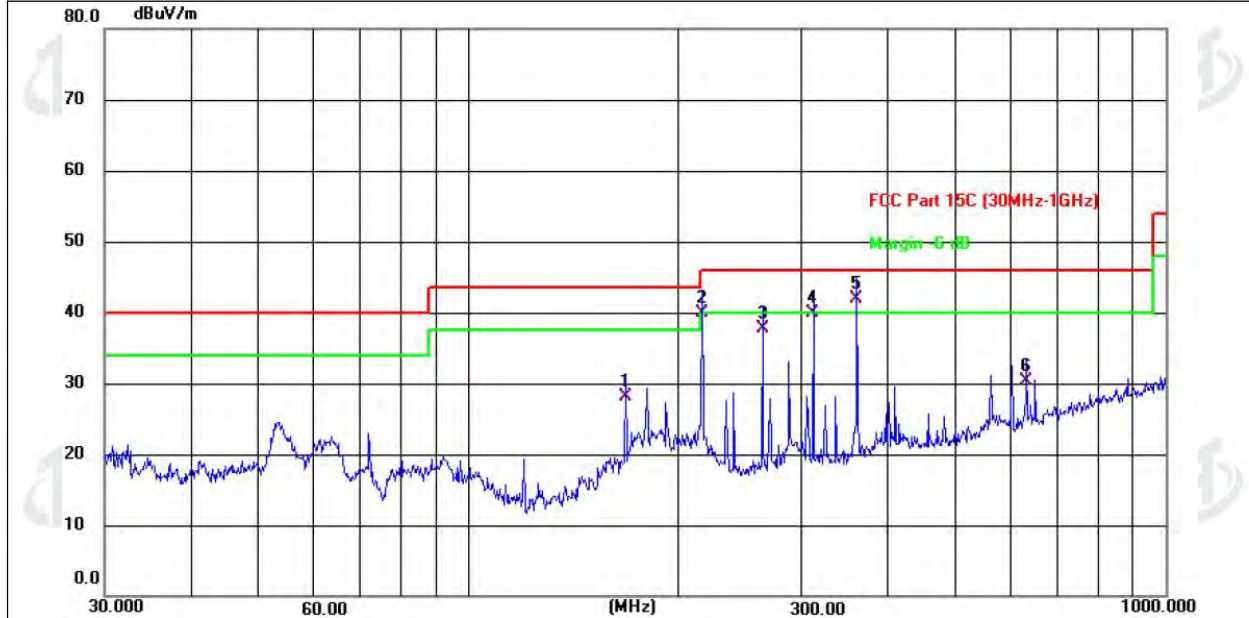

No.	Frequency (MHz)	Reading (dBuV)	Factor (dB/m)	Level (dBuV/m)	Limit (dBuV/m)	Margin (dB)	Detector
1	167.8240	40.82	-12.79	28.03	43.50	-15.47	QP
2	216.0240	49.82	-9.90	39.92	46.00	-6.08	QP
3	263.8190	46.32	-8.55	37.77	46.00	-8.23	QP
4	312.1792	47.35	-7.51	39.84	46.00	-6.16	QP
5 *	360.4476	48.51	-6.60	41.91	46.00	-4.09	QP
6	631.6883	31.90	-1.60	30.30	46.00	-15.70	QP

Remarks:

- 1.Final Level =Receiver Read level + Antenna Factor + Cable Loss – Preamplifier Factor
- 2.The emission levels of other frequencies are very lower than the limit and not show in test report.
- 3.The test data shows only the worst case 802.11b mode (Low Channel:2412MHz).



1GHz~25GHz

802.11b

Polar (H/V)	Frequency	Meter Reading	Pre-amplifier	Cable Loss	Antenna Factor	Emission Level	Limits	Margin	Detect or Type
	(MHz)	(dBuV)	(dB)	(dB)	(dB)	(dBuV/m)	(dBuV/m)	(dB)	
Low Channel:2412MHz									
V	4824.00	60.98	30.55	5.77	24.66	60.86	74	-13.14	PK
V	4824.00	43.82	30.55	5.77	24.66	43.7	54	-10.3	AV
V	7236.00	53.39	30.33	6.32	24.55	53.93	74	-20.07	PK
V	7236.00	37.66	30.33	6.32	24.55	38.2	54	-15.8	AV
V	9648.00	52.86	30.85	7.45	24.69	54.15	74	-19.85	PK
V	9648.00	34.55	30.85	7.45	24.69	35.84	54	-18.16	AV
V	12060.00	55.35	31.02	8.99	25.57	58.89	74	-15.11	PK
V	12060.00	40.66	31.02	8.99	25.57	44.2	54	-9.8	AV
H	4824.00	54.8	30.55	5.77	24.66	54.68	74	-19.32	PK
H	4824.00	37.92	30.55	5.77	24.66	37.8	54	-16.2	AV
H	7236.00	50.08	30.33	6.32	24.55	50.62	74	-23.38	PK
H	7236.00	36.6	30.33	6.32	24.55	37.14	54	-16.86	AV
H	9648.00	50.33	30.85	7.45	24.69	51.62	74	-22.38	PK
H	9648.00	34.81	30.85	7.45	24.69	36.1	54	-17.9	AV
H	12060.00	48.75	31.02	8.99	25.57	52.29	74	-21.71	PK
H	12060.00	33.06	31.02	8.99	25.57	36.6	54	-17.4	AV

Polar (H/V)	Frequency	Meter Reading	Pre-amplifier	Cable Loss	Antenna Factor	Emission Level	Limits	Margin	Detect or Type
	(MHz)	(dBuV)	(dB)	(dB)	(dB)	(dBuV/m)	(dBuV/m)	(dB)	
Middle Channel:2437MHz									
V	4874.00	62.4	30.55	5.77	24.66	62.28	74	-11.72	PK
V	4874.00	42.63	30.55	5.77	24.66	42.51	54	-11.49	AV
V	7311.00	53.85	30.33	6.32	24.55	54.39	74	-19.61	PK
V	7311.00	36.11	30.33	6.32	24.55	36.65	54	-17.35	AV
V	9748.00	52.63	30.85	7.45	24.69	53.92	74	-20.08	PK
V	9748.00	35.61	30.85	7.45	24.69	36.9	54	-17.1	AV
V	12185.00	56.61	31.02	8.99	25.57	60.15	74	-13.85	PK
V	12185.00	37.48	31.02	8.99	25.57	41.02	54	-12.98	AV
H	4874.00	55.23	30.55	5.77	24.66	55.11	74	-18.89	PK
H	4874.00	36.57	30.55	5.77	24.66	36.45	54	-17.55	AV
H	7311.00	51.57	30.33	6.32	24.55	52.11	74	-21.89	PK
H	7311.00	37.08	30.33	6.32	24.55	37.62	54	-16.38	AV
H	9748.00	48.35	30.85	7.45	24.69	49.64	74	-24.36	PK
H	9748.00	32.95	30.85	7.45	24.69	34.24	54	-19.76	AV
H	12185.00	46.93	31.02	8.99	25.57	50.47	74	-23.53	PK
H	12185.00	32.8	31.02	8.99	25.57	36.34	54	-17.66	AV



Polar (H/V)	Frequency	Meter Reading	Pre-amplifier	Cable Loss	Antenna Factor	Emission Level	Limits	Margin	Detect or Type
	(MHz)	(dBuV)	(dB)	(dB)	(dB)	(dBuV/m)	(dBuV/m)	(dB)	
High Channel:2462MHz									
V	4924.00	60.91	30.55	5.77	24.66	60.79	74	-13.21	PK
V	4924.00	42.48	30.55	5.77	24.66	42.36	54	-11.64	AV
V	7386.00	53.49	30.33	6.32	24.55	54.03	74	-19.97	PK
V	7386.00	37.41	30.33	6.32	24.55	37.95	54	-16.05	AV
V	9848.00	51.82	30.85	7.45	24.69	53.11	74	-20.89	PK
V	9848.00	34.33	30.85	7.45	24.69	35.62	54	-18.38	AV
V	12310.00	56.55	31.02	8.99	25.57	60.09	74	-13.91	PK
V	12310.00	38.12	31.02	8.99	25.57	41.66	54	-12.34	AV
H	4924.00	53.72	30.55	5.77	24.66	53.6	74	-20.4	PK
H	4924.00	37.82	30.55	5.77	24.66	37.7	54	-16.3	AV
H	7386.00	49.39	30.33	6.32	24.55	49.93	74	-24.07	PK
H	7386.00	35.24	30.33	6.32	24.55	35.78	54	-18.22	AV
H	9848.00	48.99	30.85	7.45	24.69	50.28	74	-23.72	PK
H	9848.00	36.02	30.85	7.45	24.69	37.31	54	-16.69	AV
H	12310.00	48.78	31.02	8.99	25.57	52.32	74	-21.68	PK
H	12310.00	31.29	31.02	8.99	25.57	34.83	54	-19.17	AV

Remark:

1. Emission Level = Meter Reading + Antenna Factor + Cable Loss – Pre-amplifier, Margin= Emission Level - Limit
2. If peak below the average limit, the average emission was no test.
3. The amplitude of spurious emissions which are attenuated by more than 20dB below the permissible value has no need to be reported.



802.11g

Polar (H/V)	Frequency	Meter Reading	Pre-amplifier	Cable Loss	Antenna Factor	Emission Level	Limits	Margin	Detect or Type
	(MHz)	(dBuV)	(dB)	(dB)	(dB)	(dBuV/m)	(dBuV/m)	(dB)	
Low Channel:2412MHz									
V	4824.00	60.83	30.55	5.77	24.66	60.71	74	-13.29	PK
V	4824.00	42.17	30.55	5.77	24.66	42.05	54	-11.95	AV
V	7236.00	52.69	30.33	6.32	24.55	53.23	74	-20.77	PK
V	7236.00	37.33	30.33	6.32	24.55	37.87	54	-16.13	AV
V	9648.00	52.23	30.85	7.45	24.69	53.52	74	-20.48	PK
V	9648.00	35.72	30.85	7.45	24.69	37.01	54	-16.99	AV
V	12060.00	57.39	31.02	8.99	25.57	60.93	74	-13.07	PK
V	12060.00	38.45	31.02	8.99	25.57	41.99	54	-12.01	AV
H	4824.00	53.88	30.55	5.77	24.66	53.76	74	-20.24	PK
H	4824.00	37.65	30.55	5.77	24.66	37.53	54	-16.47	AV
H	7236.00	51.17	30.33	6.32	24.55	51.71	74	-22.29	PK
H	7236.00	36.23	30.33	6.32	24.55	36.77	54	-17.23	AV
H	9648.00	48.65	30.85	7.45	24.69	49.94	74	-24.06	PK
H	9648.00	35.81	30.85	7.45	24.69	37.1	54	-16.9	AV
H	12060.00	47.55	31.02	8.99	25.57	51.09	74	-22.91	PK
H	12060.00	31.72	31.02	8.99	25.57	35.26	54	-18.74	AV

Polar (H/V)	Frequency	Meter Reading	Pre-amplifier	Cable Loss	Antenna Factor	Emission Level	Limits	Margin	Detect or Type
	(MHz)	(dBuV)	(dB)	(dB)	(dB)	(dBuV/m)	(dBuV/m)	(dB)	
Middle Channel:2437MHz									
V	4874.00	60.83	30.55	5.77	24.66	60.71	74	-13.29	PK
V	4874.00	42.17	30.55	5.77	24.66	42.05	54	-11.95	AV
V	7311.00	52.69	30.33	6.32	24.55	53.23	74	-20.77	PK
V	7311.00	37.33	30.33	6.32	24.55	37.87	54	-16.13	AV
V	9748.00	52.23	30.85	7.45	24.69	53.52	74	-20.48	PK
V	9748.00	35.72	30.85	7.45	24.69	37.01	54	-16.99	AV
V	12185.00	57.39	31.02	8.99	25.57	60.93	74	-13.07	PK
V	12185.00	38.45	31.02	8.99	25.57	41.99	54	-12.01	AV
H	4874.00	53.88	30.55	5.77	24.66	53.76	74	-20.24	PK
H	4874.00	37.65	30.55	5.77	24.66	37.53	54	-16.47	AV
H	7311.00	51.17	30.33	6.32	24.55	51.71	74	-22.29	PK
H	7311.00	36.23	30.33	6.32	24.55	36.77	54	-17.23	AV
H	9748.00	48.65	30.85	7.45	24.69	49.94	74	-24.06	PK
H	9748.00	35.81	30.85	7.45	24.69	37.1	54	-16.9	AV
H	12185.00	47.55	31.02	8.99	25.57	51.09	74	-22.91	PK
H	12185.00	31.72	31.02	8.99	25.57	35.26	54	-18.74	AV



Polar (H/V)	Frequency	Meter Reading	Pre-amplifier	Cable Loss	Antenna Factor	Emission Level	Limits	Margin	Detect or Type
	(MHz)	(dBuV)	(dB)	(dB)	(dB)	(dBuV/m)	(dBuV/m)	(dB)	
High Channel:2462MHz									
V	4924.00	61.35	30.55	5.77	24.66	61.23	74	-12.77	PK
V	4924.00	43.66	30.55	5.77	24.66	43.54	54	-10.46	AV
V	7386.00	53.94	30.33	6.32	24.55	54.48	74	-19.52	PK
V	7386.00	37.1	30.33	6.32	24.55	37.64	54	-16.36	AV
V	9848.00	52.92	30.85	7.45	24.69	54.21	74	-19.79	PK
V	9848.00	35.01	30.85	7.45	24.69	36.3	54	-17.7	AV
V	12310.00	55.47	31.02	8.99	25.57	59.01	74	-14.99	PK
V	12310.00	39.75	31.02	8.99	25.57	43.29	54	-10.71	AV
H	4924.00	53.58	30.55	5.77	24.66	53.46	74	-20.54	PK
H	4924.00	38.26	30.55	5.77	24.66	38.14	54	-15.86	AV
H	7386.00	52.28	30.33	6.32	24.55	52.82	74	-21.18	PK
H	7386.00	35.4	30.33	6.32	24.55	35.94	54	-18.06	AV
H	9848.00	49.51	30.85	7.45	24.69	50.8	74	-23.2	PK
H	9848.00	35.53	30.85	7.45	24.69	36.82	54	-17.18	AV
H	12310.00	48.16	31.02	8.99	25.57	51.7	74	-22.3	PK
H	12310.00	32.69	31.02	8.99	25.57	36.23	54	-17.77	AV

Remark:

1. Emission Level = Meter Reading + Antenna Factor + Cable Loss – Pre-amplifier, Margin= Emission Level - Limit
2. If peak below the average limit, the average emission was no test.
3. The amplitude of spurious emissions which are attenuated by more than 20dB below the permissible value has no need to be reported.



802.11n20

Polar (H/V)	Frequency	Meter Reading	Pre-amplifier	Cable Loss	Antenna Factor	Emission Level	Limits	Margin	Detect or Type
	(MHz)	(dBuV)	(dB)	(dB)	(dB)	(dBuV/m)	(dBuV/m)	(dB)	
Low Channel:2412MHz									
V	4824.00	61.31	30.55	5.77	24.66	61.19	74	-12.81	PK
V	4824.00	42.51	30.55	5.77	24.66	42.39	54	-11.61	AV
V	7236.00	53.29	30.33	6.32	24.55	53.83	74	-20.17	PK
V	7236.00	36.59	30.33	6.32	24.55	37.13	54	-16.87	AV
V	9648.00	51.91	30.85	7.45	24.69	53.2	74	-20.8	PK
V	9648.00	35.3	30.85	7.45	24.69	36.59	54	-17.41	AV
V	12060.00	57.85	31.02	8.99	25.57	61.39	74	-12.61	PK
V	12060.00	36.3	31.02	8.99	25.57	39.84	54	-14.16	AV
H	4824.00	55.38	30.55	5.77	24.66	55.26	74	-18.74	PK
H	4824.00	37.49	30.55	5.77	24.66	37.37	54	-16.63	AV
H	7236.00	52.66	30.33	6.32	24.55	53.2	74	-20.8	PK
H	7236.00	35.61	30.33	6.32	24.55	36.15	54	-17.85	AV
H	9648.00	48.56	30.85	7.45	24.69	49.85	74	-24.15	PK
H	9648.00	34.77	30.85	7.45	24.69	36.06	54	-17.94	AV
H	12060.00	48.11	31.02	8.99	25.57	51.65	74	-22.35	PK
H	12060.00	32.88	31.02	8.99	25.57	36.42	54	-17.58	AV

Polar (H/V)	Frequency	Meter Reading	Pre-amplifier	Cable Loss	Antenna Factor	Emission Level	Limits	Margin	Detect or Type
	(MHz)	(dBuV)	(dB)	(dB)	(dB)	(dBuV/m)	(dBuV/m)	(dB)	
Middle Channel:2437MHz									
V	4874.00	59.84	30.55	5.77	24.66	59.72	74	-14.28	PK
V	4874.00	42.07	30.55	5.77	24.66	41.95	54	-12.05	AV
V	7311.00	53.27	30.33	6.32	24.55	53.81	74	-20.19	PK
V	7311.00	37.02	30.33	6.32	24.55	37.56	54	-16.44	AV
V	9748.00	53.11	30.85	7.45	24.69	54.4	74	-19.6	PK
V	9748.00	34.06	30.85	7.45	24.69	35.35	54	-18.65	AV
V	12185.00	55.68	31.02	8.99	25.57	59.22	74	-14.78	PK
V	12185.00	37.92	31.02	8.99	25.57	41.46	54	-12.54	AV
H	4874.00	53.74	30.55	5.77	24.66	53.62	74	-20.38	PK
H	4874.00	37.16	30.55	5.77	24.66	37.04	54	-16.96	AV
H	7311.00	50.35	30.33	6.32	24.55	50.89	74	-23.11	PK
H	7311.00	35.02	30.33	6.32	24.55	35.56	54	-18.44	AV
H	9748.00	48.54	30.85	7.45	24.69	49.83	74	-24.17	PK
H	9748.00	34.32	30.85	7.45	24.69	35.61	54	-18.39	AV
H	12185.00	46.51	31.02	8.99	25.57	50.05	74	-23.95	PK
H	12185.00	32.95	31.02	8.99	25.57	36.49	54	-17.51	AV



Polar (H/V)	Frequency	Meter Reading	Pre-amplifier	Cable Loss	Antenna Factor	Emission Level	Limits	Margin	Detect or Type
	(MHz)	(dBuV)	(dB)	(dB)	(dB)	(dBuV/m)	(dBuV/m)	(dB)	
High Channel:2462MHz									
V	4924.00	62.6	30.55	5.77	24.66	62.48	74	-11.52	PK
V	4924.00	44.88	30.55	5.77	24.66	44.76	54	-9.24	AV
V	7386.00	53.26	30.33	6.32	24.55	53.8	74	-20.2	PK
V	7386.00	38.48	30.33	6.32	24.55	39.02	54	-14.98	AV
V	9848.00	51.86	30.85	7.45	24.69	53.15	74	-20.85	PK
V	9848.00	36.91	30.85	7.45	24.69	38.2	54	-15.8	AV
V	12310.00	55.21	31.02	8.99	25.57	58.75	74	-15.25	PK
V	12310.00	38.41	31.02	8.99	25.57	41.95	54	-12.05	AV
H	4924.00	53.35	30.55	5.77	24.66	53.23	74	-20.77	PK
H	4924.00	37.19	30.55	5.77	24.66	37.07	54	-16.93	AV
H	7386.00	48.86	30.33	6.32	24.55	49.4	74	-24.6	PK
H	7386.00	36.37	30.33	6.32	24.55	36.91	54	-17.09	AV
H	9848.00	49.13	30.85	7.45	24.69	50.42	74	-23.58	PK
H	9848.00	34.69	30.85	7.45	24.69	35.98	54	-18.02	AV
H	12310.00	47.75	31.02	8.99	25.57	51.29	74	-22.71	PK
H	12310.00	32.62	31.02	8.99	25.57	36.16	54	-17.84	AV

Remark:

1. Emission Level = Meter Reading + Antenna Factor + Cable Loss – Pre-amplifier, Margin= Emission Level - Limit
2. If peak below the average limit, the average emission was no test.
3. The amplitude of spurious emissions which are attenuated by more than 20dB below the permissible value has no need to be reported.



802.11n40

Polar (H/V)	Frequency	Meter Reading	Pre-amplifier	Cable Loss	Antenna Factor	Emission Level	Limits	Margin	Detect or Type
	(MHz)	(dBuV)	(dB)	(dB)	(dB)	(dBuV/m)	(dBuV/m)	(dB)	
Low Channel:2422MHz									
V	4844	58.5	30.55	5.77	24.66	58.38	74	-15.62	PK
V	4844	42.81	30.55	5.77	24.66	42.69	54	-11.31	AV
V	7266	53.05	30.33	6.32	24.55	53.59	74	-20.41	PK
V	7266	36.1	30.33	6.32	24.55	36.64	54	-17.36	AV
V	9688	51.42	30.85	7.45	24.69	52.71	74	-21.29	PK
V	9688	36.26	30.85	7.45	24.69	37.55	54	-16.45	AV
V	12110	57.55	31.02	8.99	25.57	61.09	74	-12.91	PK
V	12110	36.51	31.02	8.99	25.57	40.05	54	-13.95	AV
H	4824.00	52.59	30.55	5.77	24.66	52.47	74	-21.53	PK
H	4824.00	37.5	30.55	5.77	24.66	37.38	54	-16.62	AV
H	7236.00	52.6	30.33	6.32	24.55	53.14	74	-20.86	PK
H	7236.00	36.12	30.33	6.32	24.55	36.66	54	-17.34	AV
H	9648.00	49.91	30.85	7.45	24.69	51.2	74	-22.8	PK
H	9648.00	35.17	30.85	7.45	24.69	36.46	54	-17.54	AV
H	12060.00	47.48	31.02	8.99	25.57	51.02	74	-22.98	PK
H	12060.00	34.72	31.02	8.99	25.57	38.26	54	-15.74	AV

Polar (H/V)	Frequency	Meter Reading	Pre-amplifier	Cable Loss	Antenna Factor	Emission Level	Limits	Margin	Detect or Type
	(MHz)	(dBuV)	(dB)	(dB)	(dB)	(dBuV/m)	(dBuV/m)	(dB)	
Middle Channel:2437MHz									
V	4874.00	61.62	30.55	5.77	24.66	61.5	74	-12.5	PK
V	4874.00	43.07	30.55	5.77	24.66	42.95	54	-11.05	AV
V	7311.00	52.43	30.33	6.32	24.55	52.97	74	-21.03	PK
V	7311.00	37.2	30.33	6.32	24.55	37.74	54	-16.26	AV
V	9748.00	49.94	30.85	7.45	24.69	51.23	74	-22.77	PK
V	9748.00	36.44	30.85	7.45	24.69	37.73	54	-16.27	AV
V	12185.00	56.2	31.02	8.99	25.57	59.74	74	-14.26	PK
V	12185.00	37.79	31.02	8.99	25.57	41.33	54	-12.67	AV
H	4874.00	53.34	30.55	5.77	24.66	53.22	74	-20.78	PK
H	4874.00	35.95	30.55	5.77	24.66	35.83	54	-18.17	AV
H	7311.00	52.41	30.33	6.32	24.55	52.95	74	-21.05	PK
H	7311.00	36.92	30.33	6.32	24.55	37.46	54	-16.54	AV
H	9748.00	49.35	30.85	7.45	24.69	50.64	74	-23.36	PK
H	9748.00	34.62	30.85	7.45	24.69	35.91	54	-18.09	AV
H	12185.00	46.94	31.02	8.99	25.57	50.48	74	-23.52	PK
H	12185.00	34.19	31.02	8.99	25.57	37.73	54	-16.27	AV



Polar (H/V)	Frequency	Meter Reading	Pre-amplifier	Cable Loss	Antenna Factor	Emission Level	Limits	Margin	Detect or Type
	(MHz)	(dBuV)	(dB)	(dB)	(dB)	(dBuV/m)	(dBuV/m)	(dB)	
High Channel:2452MHz									
V	4904.00	62.1	30.55	5.77	24.66	61.98	74	-12.02	PK
V	4904.00	44.06	30.55	5.77	24.66	43.94	54	-10.06	AV
V	7356.00	53.93	30.33	6.32	24.55	54.47	74	-19.53	PK
V	7356.00	38.35	30.33	6.32	24.55	38.89	54	-15.11	AV
V	9808.00	52.24	30.85	7.45	24.69	53.53	74	-20.47	PK
V	9808.00	34.03	30.85	7.45	24.69	35.32	54	-18.68	AV
V	12260.00	56.31	31.02	8.99	25.57	59.85	74	-14.15	PK
V	12260.00	40.04	31.02	8.99	25.57	43.58	54	-10.42	AV
H	4904.00	56.18	30.55	5.77	24.66	56.06	74	-17.94	PK
H	4904.00	37.17	30.55	5.77	24.66	37.05	54	-16.95	AV
H	7356.00	50.5	30.33	6.32	24.55	51.04	74	-22.96	PK
H	7356.00	36.58	30.33	6.32	24.55	37.12	54	-16.88	AV
H	9808.00	51.1	30.85	7.45	24.69	52.39	74	-21.61	PK
H	9808.00	36.94	30.85	7.45	24.69	38.23	54	-15.77	AV
H	12260.00	48.59	31.02	8.99	25.57	52.13	74	-21.87	PK
H	12260.00	33	31.02	8.99	25.57	36.54	54	-17.46	AV

Remark:

1. Emission Level = Meter Reading + Antenna Factor + Cable Loss – Pre-amplifier, Margin= Emission Level - Limit
2. If peak below the average limit, the average emission was no test.
3. The amplitude of spurious emissions which are attenuated by more than 20dB below the permissible value has no need to be reported.



5.RADIATED BAND EMISSIONMEASUREMENT

5.1 TEST REQUIREMENT:

Test Requirement:	FCC Part15 C Section 15.209 and 15.205				
Test Method:	ANSI C63.10: 2013				
Test Frequency Range:	All of the restrict bands were tested, only the worst band's (2310MHz to 2500MHz) data was showed.				
Test site:	Measurement Distance: 3m				
Receiver setup:	Frequency	Detector	RBW	VBW	Value
	Above 1GHz	Peak	1MHz	3MHz	Peak
		Average	1MHz	3MHz	Average

LIMITS OF RADIATED EMISSION MEASUREMENT (Above 1000MHz)

FREQUENCY (MHz)	Class B (dBuV/m) (at 3M)	
	PEAK	AVERAGE
Above 1000	74	54

Notes:

- (1) The limit for radiated test was performed according to FCC PART 15C.
- (2) The tighter limit applies at the band edges.
- (3) Emission level (dBuV/m)=20log Emission level (uV/m).

5.2 TEST PROCEDURE

Above 1GHz test procedure as below:

- a. 1. The EUT was placed on the top of a rotating table 1.5 meters above the ground at a 3 meter camber. The table was rotated 360 degrees to determine the position of the highest radiation.
- b. The EUT was set 3 meters away from the interference-receiving antenna, which was mounted on the top of a variable-height antenna tower.
- c. The antenna height is varied from one meter to four meters above the ground to determine the maximum value of the field strength. Both horizontal and vertical polarizations of the antenna are set to make the measurement.
- d. For each suspected emission, the EUT was arranged to its worst case and then the antenna was tuned to heights from 1 meter to 4 meters and the rota table was turned from 0 degrees to 360 degrees to find the maximum reading.
- e. The test-receiver system was set to Peak Detect Function and Specified Bandwidth with Maximum Hold Mode.
- f. If the emission level of the EUT in peak mode was 10dB lower than the limit specified, then testing could be stopped and the peak values of the EUT would be reported. Otherwise the emissions that did not have 10dBmargin would be re-tested one by one using peak, quasi-peak or average method as specified and then reported in a data sheet.
- g. Test the EUT in the lowest channel, the Highest channel

Note:

Both horizontal and vertical antenna polarities were tested and performed pretest to three orthogonal axis. The worst case emissions were reported

5.3 DEVIATION FROM TEST STANDARD

No deviation

5.4 TEST SETUP

Radiated Emission Test-Up Frequency Above 1GHz

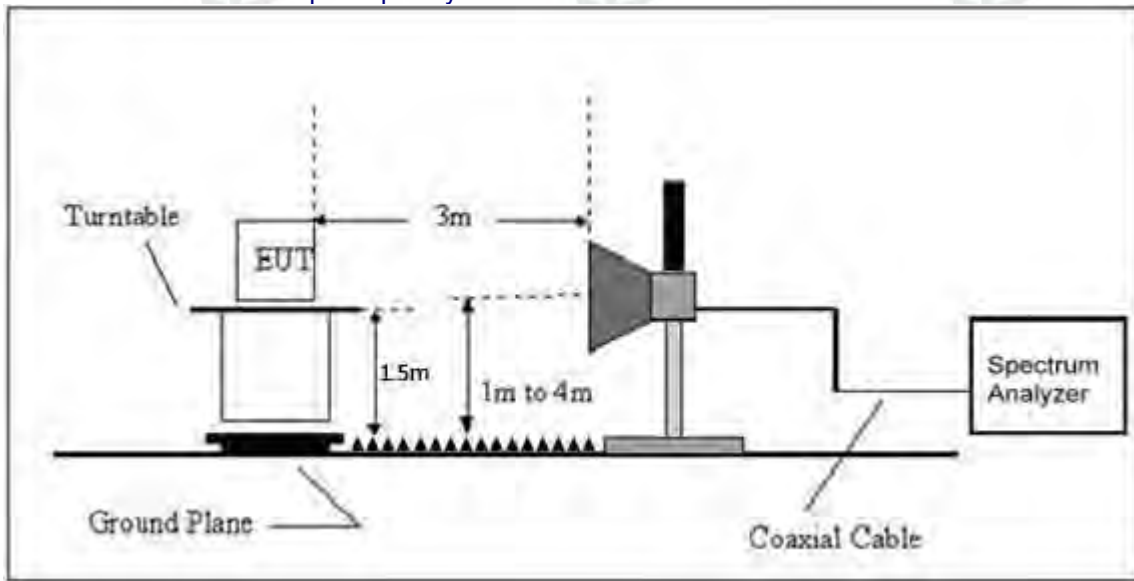

5.5 EUT OPERATING CONDITIONS

The EUT tested system was configured as the statements of 2.3 Unless otherwise a special operating condition is specified in the follows during the testing.



5.6 TEST RESULT

	Polar (H/V)	Frequenc y (MHz)	Meter Reading (dBuV)	Pre-amplifier (dB)	Cable Loss (dB)	Antenna Factor (dB/m)	Emission level (dBuV/m)	Limit (dBuV /m)	Margi n (dB)	Detec tor Type	Result
802.11b	Low Channel 2412MHz										
	H	2390.00	57.51	30.22	4.85	23.98	56.12	74	-17.88	PK	PASS
	H	2390.00	46.01	30.22	4.85	23.98	44.62	54	-9.38	AV	PASS
	H	2400.00	58.84	30.22	4.85	23.98	57.45	74	-16.55	PK	PASS
	H	2400.00	50.48	30.22	4.85	23.98	49.09	54	-4.91	AV	PASS
	V	2390.00	58.92	30.22	4.85	23.98	57.53	74	-16.47	PK	PASS
	V	2390.00	49.4	30.22	4.85	23.98	48.01	54	-5.99	AV	PASS
	V	2400.00	61.02	30.22	4.85	23.98	59.63	74	-14.37	PK	PASS
	V	2400.00	50.09	30.22	4.85	23.98	48.7	54	-5.3	AV	PASS
	High Channel 2462MHz										
	H	2483.50	57.34	30.22	4.85	23.98	55.95	74	-18.05	PK	PASS
	H	2483.50	46.24	30.22	4.85	23.98	44.85	54	-9.15	AV	PASS
	H	2485.50	61.42	30.22	4.85	23.98	60.03	74	-13.97	PK	PASS
	H	2485.50	50.32	30.22	4.85	23.98	48.93	54	-5.07	AV	PASS
	V	2483.50	61.06	30.22	4.85	23.98	59.67	74	-14.33	PK	PASS
	V	2483.50	49.1	30.22	4.85	23.98	47.71	54	-6.29	AV	PASS
V	2485.50	57.63	30.22	4.85	23.98	56.24	74	-17.76	PK	PASS	
V	2485.50	48.89	30.22	4.85	23.98	47.5	54	-6.5	AV	PASS	
802.11g	Low Channel 2412MHz										
	H	2390.00	57.84	30.22	4.85	23.98	56.45	74	-17.55	PK	PASS
	H	2390.00	46.57	30.22	4.85	23.98	45.18	54	-8.82	AV	PASS
	H	2400.00	61.72	30.22	4.85	23.98	60.33	74	-13.67	PK	PASS
	H	2400.00	48.31	30.22	4.85	23.98	46.92	54	-7.08	AV	PASS
	V	2390.00	58.44	30.22	4.85	23.98	57.05	74	-16.95	PK	PASS
	V	2390.00	48.18	30.22	4.85	23.98	46.79	54	-7.21	AV	PASS
	V	2400.00	60.74	30.22	4.85	23.98	59.35	74	-14.65	PK	PASS
	V	2400.00	48.78	30.22	4.85	23.98	47.39	54	-6.61	AV	PASS
	High Channel 2462MHz										
	H	2483.50	58.84	30.22	4.85	23.98	57.45	74	-16.55	PK	PASS
	H	2483.50	46.64	30.22	4.85	23.98	45.25	54	-8.75	AV	PASS
	H	2485.50	60.81	30.22	4.85	23.98	59.42	74	-14.58	PK	PASS
	H	2485.50	49.25	30.22	4.85	23.98	47.86	54	-6.14	AV	PASS
	V	2483.50	62.39	30.22	4.85	23.98	61	74	-13	PK	PASS
	V	2483.50	48.28	30.22	4.85	23.98	46.89	54	-7.11	AV	PASS
V	2485.50	59.48	30.22	4.85	23.98	58.09	74	-15.91	PK	PASS	
V	2485.50	46.39	30.22	4.85	23.98	45	54	-9	AV	PASS	
802.11n2 0	Low Channel 2412MHz										
	H	2390.00	59.65	30.22	4.85	23.98	58.26	74	-15.74	PK	PASS
	H	2390.00	47.7	30.22	4.85	23.98	46.31	54	-7.69	AV	PASS
	H	2400.00	61.13	30.22	4.85	23.98	59.74	74	-14.26	PK	PASS
	H	2400.00	49.79	30.22	4.85	23.98	48.4	54	-5.6	AV	PASS
	V	2390.00	58.38	30.22	4.85	23.98	56.99	74	-17.01	PK	PASS
	V	2390.00	45.92	30.22	4.85	23.98	44.53	54	-9.47	AV	PASS
	V	2400.00	61.91	30.22	4.85	23.98	60.52	74	-13.48	PK	PASS
	V	2400.00	47.72	30.22	4.85	23.98	46.33	54	-7.67	AV	PASS
	High Channel 2462MHz										
	H	2483.50	57.58	30.22	4.85	23.98	56.19	74	-17.81	PK	PASS
	H	2483.50	46.44	30.22	4.85	23.98	45.05	54	-8.95	AV	PASS
	H	2485.50	61.2	30.22	4.85	23.98	59.81	74	-14.19	PK	PASS
	H	2485.50	49.48	30.22	4.85	23.98	48.09	54	-5.91	AV	PASS
	V	2483.50	59.83	30.22	4.85	23.98	58.44	74	-15.56	PK	PASS
	V	2483.50	48.06	30.22	4.85	23.98	46.67	54	-7.33	AV	PASS



	V	2485.50	57.72	30.22	4.85	23.98	56.33	74	-17.67	PK	PASS
	V	2485.50	45.88	30.22	4.85	23.98	44.49	54	-9.51	AV	PASS
	Low Channel 2422MHz										
	H	2390.00	58.77	30.22	4.85	23.98	57.38	74	-16.62	PK	PASS
	H	2390.00	46.49	30.22	4.85	23.98	45.1	54	-8.9	AV	PASS
	H	2400.00	60.4	30.22	4.85	23.98	59.01	74	-14.99	PK	PASS
	H	2400.00	48	30.22	4.85	23.98	46.61	54	-7.39	AV	PASS
	V	2390.00	58.87	30.22	4.85	23.98	57.48	74	-16.52	PK	PASS
	V	2390.00	47	30.22	4.85	23.98	45.61	54	-8.39	AV	PASS
	V	2400.00	59.92	30.22	4.85	23.98	58.53	74	-15.47	PK	PASS
	V	2400.00	49.1	30.22	4.85	23.98	47.71	54	-6.29	AV	PASS
	High Channel 2452MHz										
	H	2483.50	57.3	30.22	4.85	23.98	55.91	74	-18.09	PK	PASS
	H	2483.50	48.3	30.22	4.85	23.98	46.91	54	-7.09	AV	PASS
	H	2485.50	61.8	30.22	4.85	23.98	60.41	74	-13.59	PK	PASS
	H	2485.50	51.96	30.22	4.85	23.98	50.57	54	-3.43	AV	PASS
	V	2483.50	60.42	30.22	4.85	23.98	59.03	74	-14.97	PK	PASS
	V	2483.50	50.06	30.22	4.85	23.98	48.67	54	-5.33	AV	PASS
	V	2485.50	58.82	30.22	4.85	23.98	57.43	74	-16.57	PK	PASS
	V	2485.50	46.5	30.22	4.85	23.98	45.11	54	-8.89	AV	PASS

Remark:

1. Emission Level = Meter Reading + Antenna Factor + Cable Loss – Pre-amplifier, Margin= Emission Level - Limit

6. POWER SPECTRAL DENSITY TEST

Test Requirement:	FCC Part15 C Section 15.247 (e)
Test Method:	KDB558074 D0115.247 Meas Guidancev05r02

6.1 APPLIED PROCEDURES / LIMIT

FCC Part15 (15.247) , Subpart C				
Section	Test Item	Limit	Frequency Range (MHz)	Result
15.247	Power Spectral Density	8dBm/3kHz	2400-2483.5	PASS

6.2 TEST PROCEDURE

1. Set analyzer center frequency to DTS channel center frequency.
2. Set the span to 1.5 times the DTS bandwidth.
3. Set the RBW to: $3 \text{ kHz} \leq \text{RBW} \leq 100 \text{ kHz}$.
4. Set the VBW $\geq 3 \times \text{RBW}$.
5. Detector = peak.
6. Sweep time = auto couple.
7. Trace mode = max hold.
8. Allow trace to fully stabilize.
9. Use the peak marker function to determine the maximum amplitude level within the RBW.
10. If measured value exceeds limit, reduce RBW (no less than 3 kHz) and repeat.

6.3 DEVIATION FROM STANDARD

No deviation.

6.4 TEST SETUP**6.5 EUT OPERATION CONDITIONS**

The EUT tested system was configured as the statements of 2.1 Unless otherwise a special operating condition is specified in the follows during the testing.



6.6 TEST RESULT

Temperature :	25.4°C	Relative Humidity :	52%
Pressure :	101kPa	Test Voltage :	DC 3.7V
Test Mode :	TX b Mode		

Frequency	Power Spectral Density (dBm/3kHz)	Limit (dBm/3kHz)	Result
2412 MHz	-19.06	8	PASS
2437 MHz	-18.45	8	PASS
2462 MHz	-18.14	8	PASS

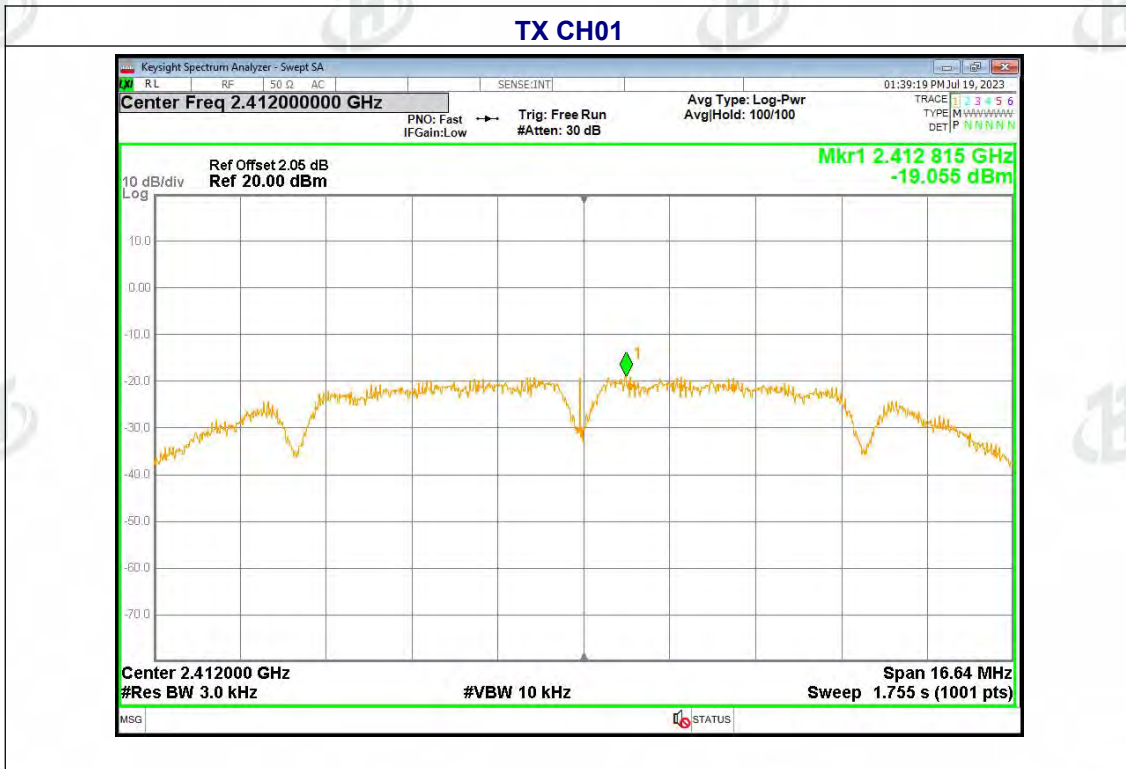





Temperature :	25.4°C	Relative Humidity :	52%
Pressure :	101kPa	Test Voltage :	DC 3.7V
Test Mode :	TX g Mode		

Frequency	Power Spectral Density (dBm/3kHz)	Limit (dBm/3kHz)	Result
2412 MHz	-18.2	8	PASS
2437 MHz	-17.56	8	PASS
2462 MHz	-17.09	8	PASS

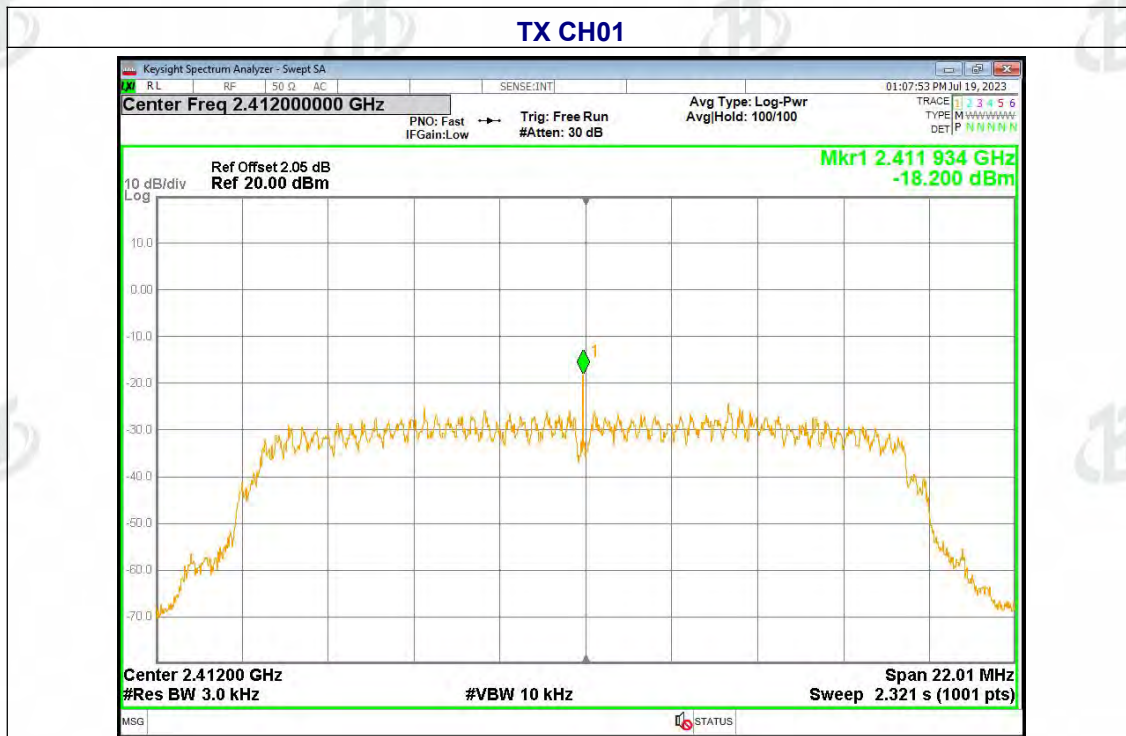

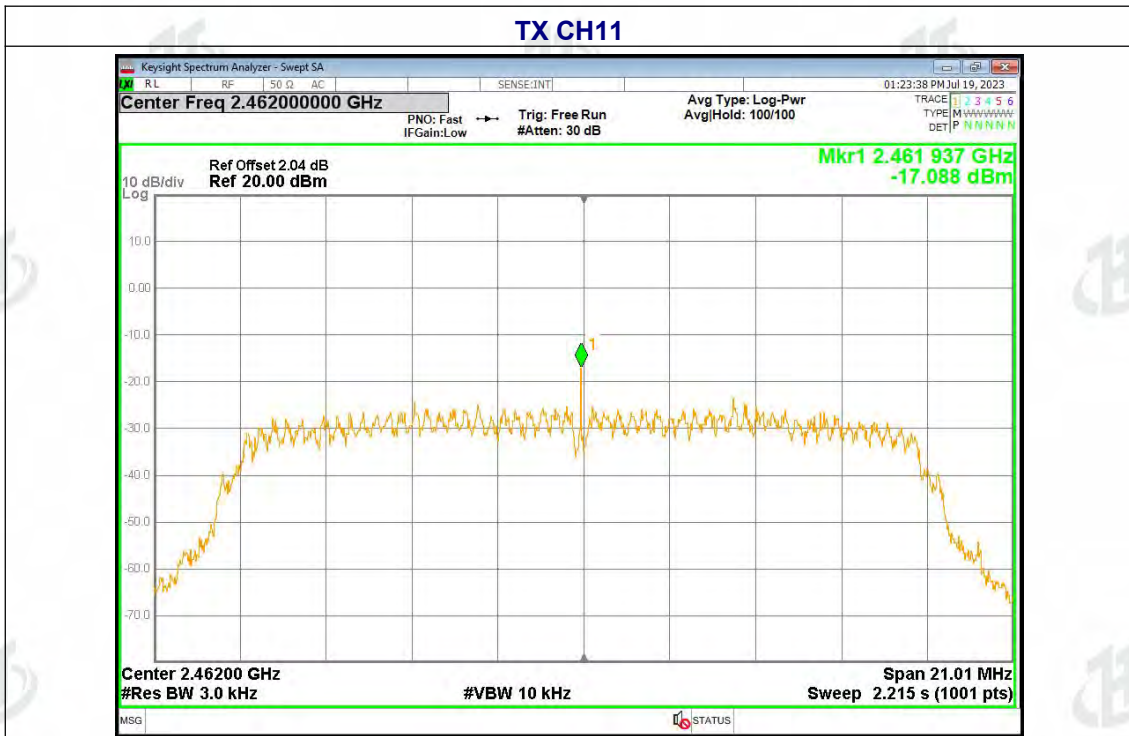
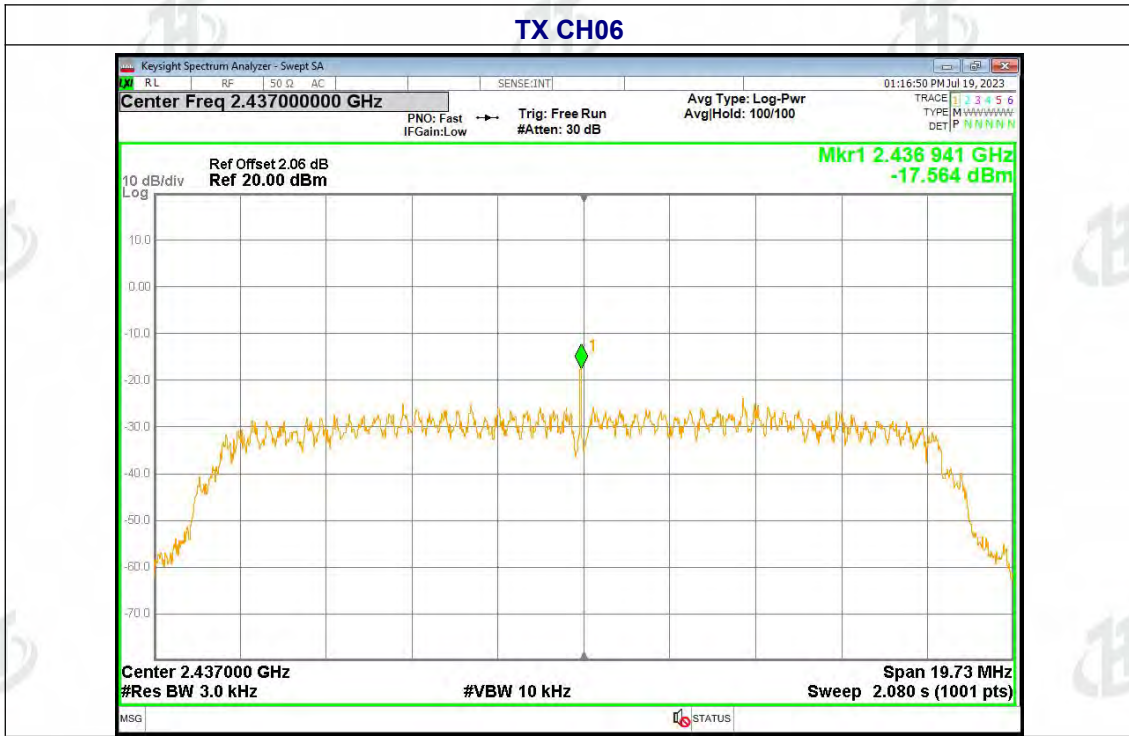



Temperature :	25.4°C	Relative Humidity :	52%
Pressure :	101kPa	Test Voltage :	DC 3.7V
Test Mode :	TX n Mode(20M)		

Frequency	Power Spectral Density (dBm/3kHz)	Limit (dBm/3kHz)	Result
2412 MHz	-17.81	8	PASS
2437 MHz	-16.99	8	PASS
2462 MHz	-16.64	8	PASS

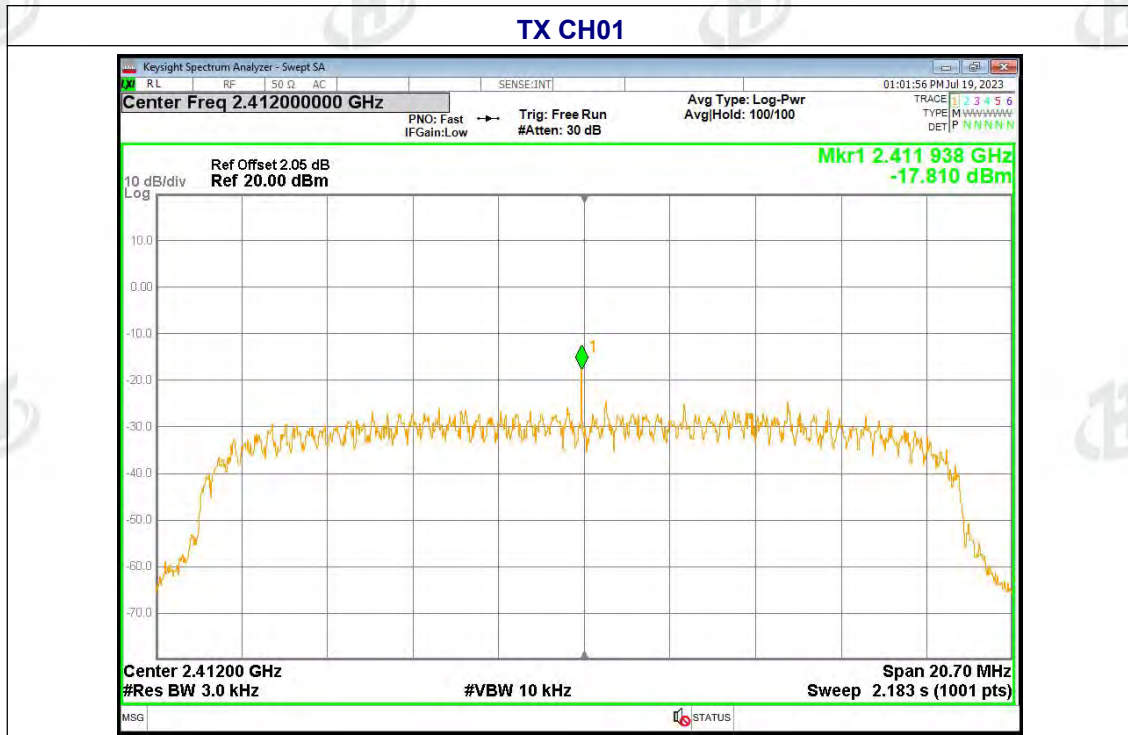



TX CH06



TX CH11

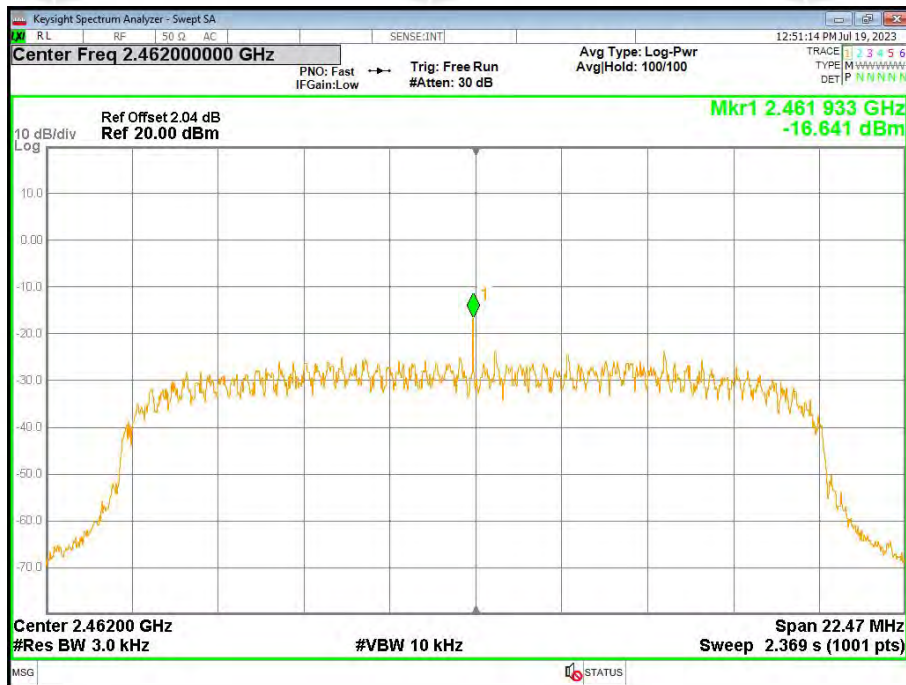



Temperature :	25.4 °C	Relative Humidity :	52%
Pressure :	101kPa	Test Voltage :	DC 3.7V
Test Mode :	TX n Mode(40M)		

Frequency	Power Spectral Density (dBm/3kHz)	Limit (dBm/3kHz)	Result
2422 MHz	-17.86	8	PASS
2437 MHz	-18.05	8	PASS
2452 MHz	-17.45	8	PASS

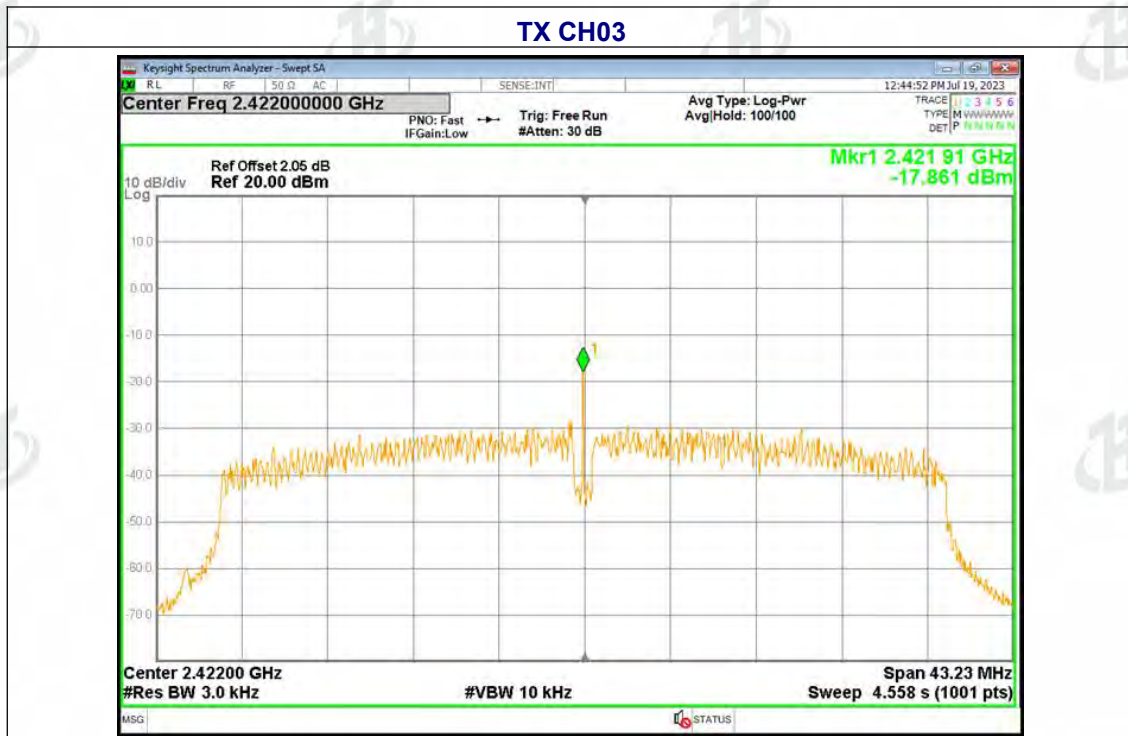

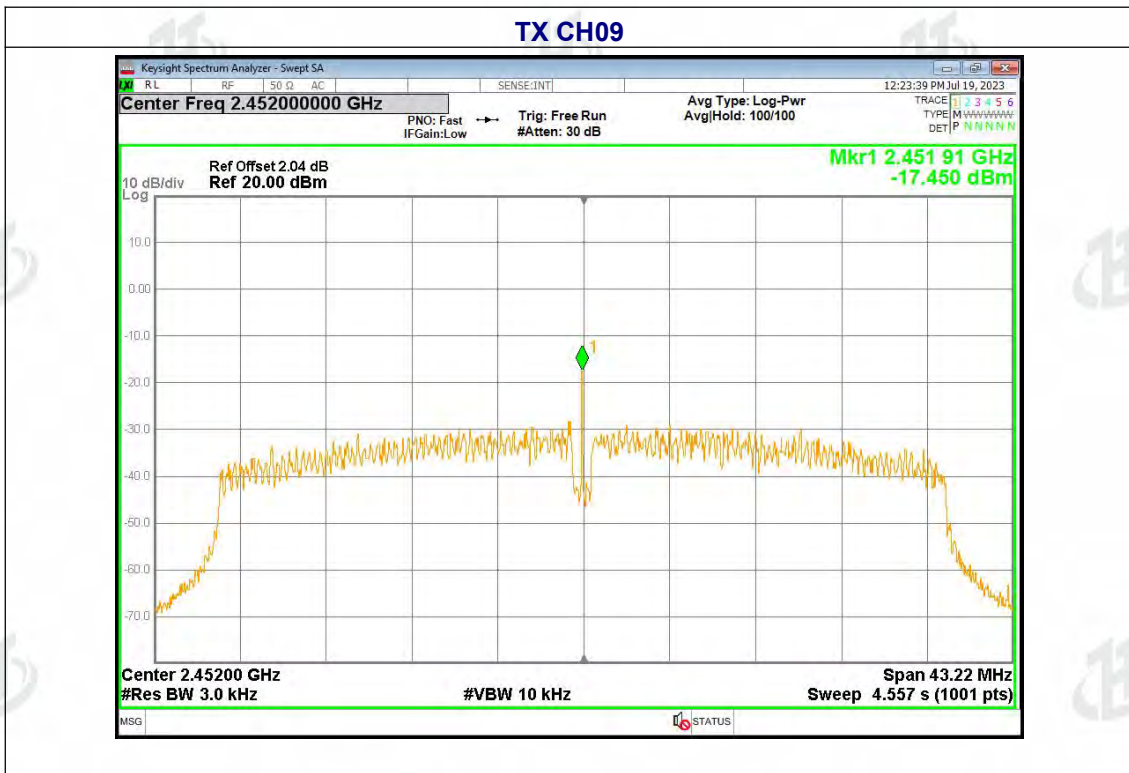
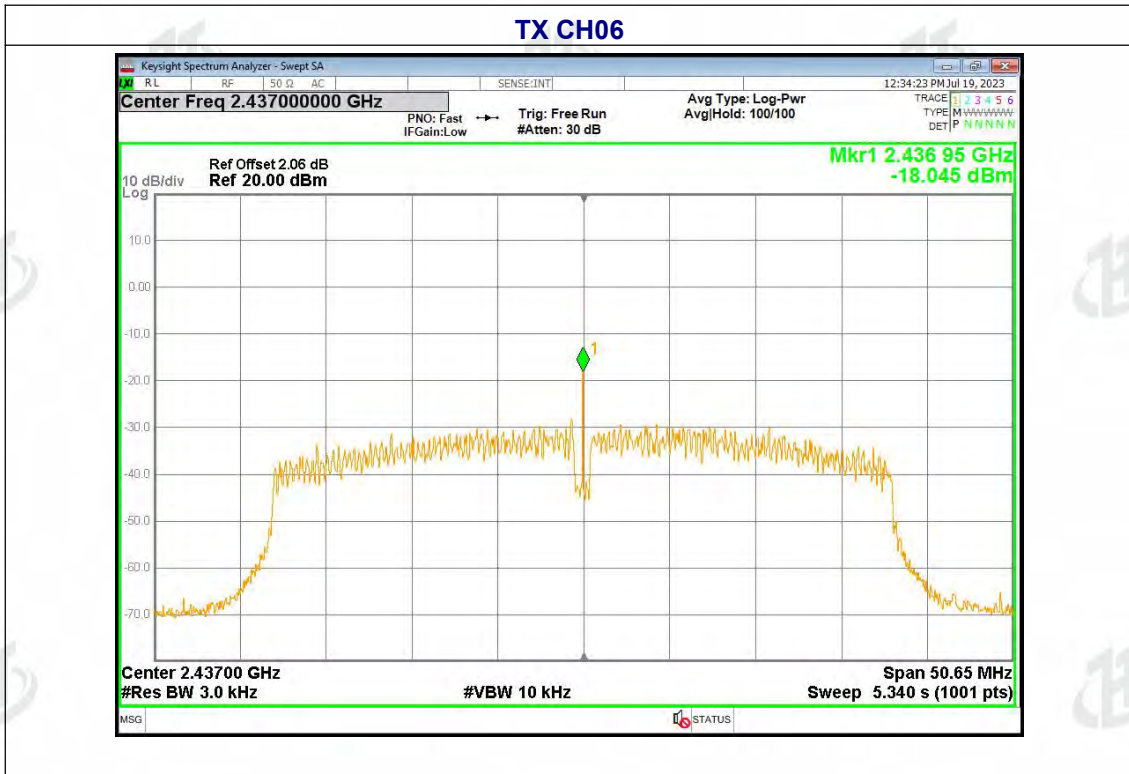



7. CHANNEL BANDWIDTH& 99% OCCUPY BANDWIDTH

Test Requirement:	FCC Part15 C Section 15.247 (a)(2)
Test Method:	KDB558074 D0115.247 Meas Guidancev05r02

7.1 APPLIED PROCEDURES / LIMIT

FCC Part15 (15.247) , Subpart C				
Section	Test Item	Limit	Frequency Range (MHz)	Result
15.247(a)(2)	Bandwidth	>= 500KHz (6dB bandwidth)	2400-2483.5	PASS

7.2 TEST PROCEDURE

1. Set RBW = 100 kHz.
2. Set the video bandwidth (VBW) ≥ 3 xRBW.
3. Detector = Peak.
4. Trace mode = max hold.
5. Sweep = auto couple.
6. Allow the trace to stabilize.
7. Measure the maximum width of the emission that is constrained by the frequencies associated with the two outermost amplitude points (upper and lower frequencies) that are attenuated by 6 dB relative to the maximum level measured in the fundamental emission.

7.3 DEVIATION FROM STANDARD

No deviation.

7.4 TEST SETUP



7.5 EUT OPERATION CONDITIONS

The EUT tested system was configured as the statements of 2.4 Unless otherwise a special operating condition is specified in the follows during the testing.



7.6 TEST RESULT

Temperature :	25.4℃	Relative Humidity :	52%
Pressure :	101kPa	Test Voltage :	DC 3.7V
Test Mode :	TX Mode		

Test CH	-6dB Occupy Bandwidth (MHz)				Limit(KHz)	Result
	802.11b	802.11g	802.11n (HT20)	802.11n (HT40)		
Lowest	11.095	14.674	11.325	28.818	>500	Pass
Middle	11.094	13.15	14.993	33.765		
Highest	12.05	14.007	14.979	28.815		



Test plot as follows:

802.11b

802.11g

Lowest channel

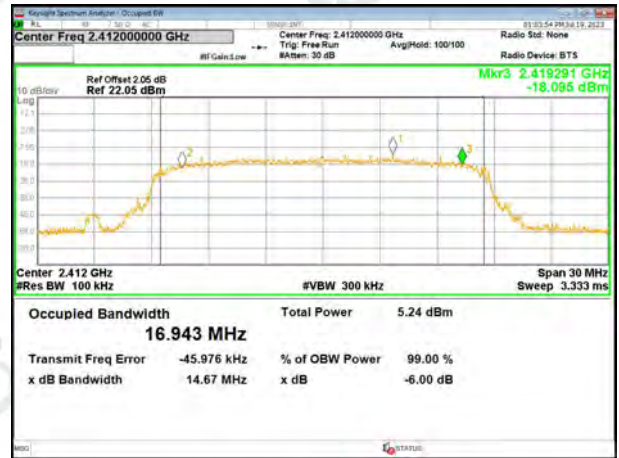
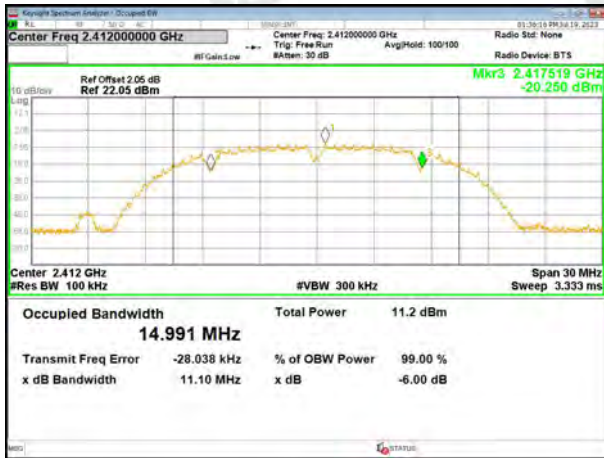

Middle channel



Highest channel





802.11n(HT20)

802.11n(HT40)

Lowest channel

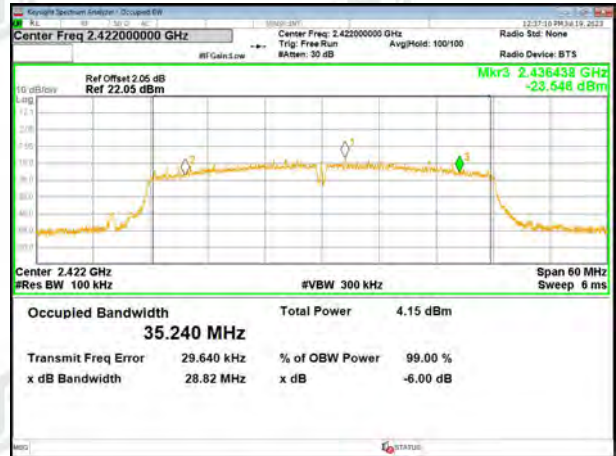
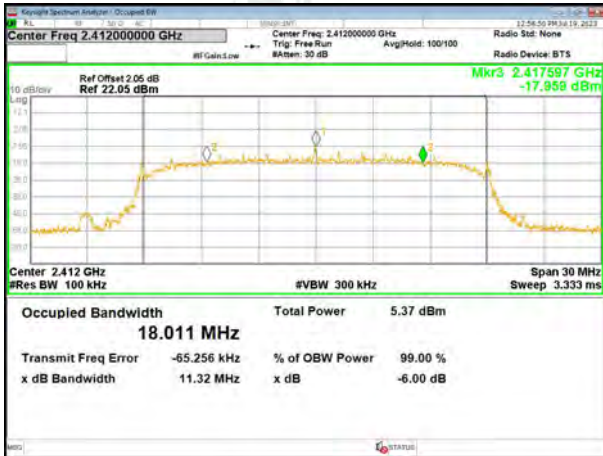

Middle channel

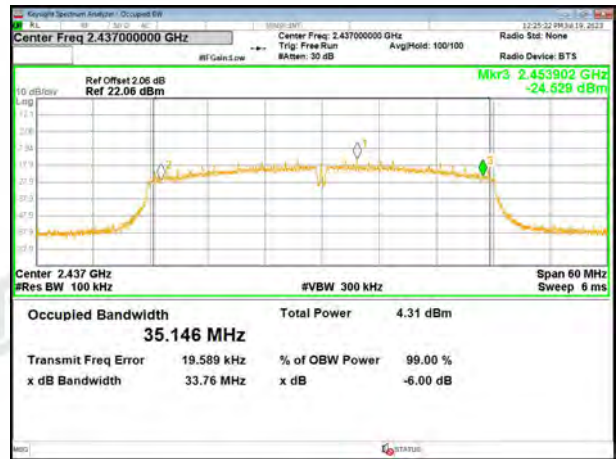
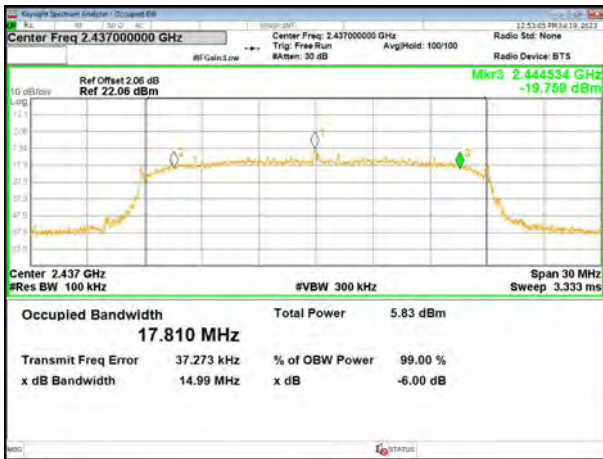

Highest channel





8. PEAK OUTPUT POWER TEST

Test Requirement:	FCC Part15 C Section 15.247 (b)(3)
Test Method:	KDB558074 D0115.247 Meas Guidanceev05r02

8.1 APPLIED PROCEDURES/LIMIT

FCC Part15 (15.247) , Subpart C				
Section	Test Item	Limit	Frequency Range (MHz)	Result
15.247(b)(3)	Peak Output Power	1 watt or 30dBm	2400-2483.5	PASS

8.2 TEST PROCEDURE

- a. The EUT was directly connected to the Power meter

8.3 DEVIATION FROM STANDARD

No deviation.

8.4 TEST SETUP



8.5 EUT OPERATION CONDITIONS

The EUT tested system was configured as the statements of 2.4 Unless otherwise a special operating condition is specified in the follows during the testing.



8.6 TEST RESULT

Temperature :	25.2°C	Relative Humidity :	55%
Pressure :	101kPa	Test Voltage :	DC 3.7V

Test CH	Peak Output Power (dBm)				Limit(dBm)	Result
	802.11b	802.11g	802.11n (HT20)	802.11 (HT40)		
Lowest	6.21	4.11	4.04	2.71	30	Pass
Middle	6.61	4.57	4.56	2.87		
Highest	7.25	4.98	4.95	2.94		



9. CONDUCTED BAND EDGE AND SPURIOUS EMISSION

Test Requirement:	FCC Part15 C Section 15.247 (d)
Test Method:	KDB558074 D0115.247 Meas Guidancev05r02

9.1 APPLICABLE STANDARD

in any 100 kHz bandwidth outside the frequency bands in which the spread spectrum intentional radiator in operating, the radio frequency power that is produced by the intentional radiator shall be at least 20dB below that in the 100kHz bandwidth within the band that contains the highest level of the desired power, In addition, radiated emissions which fall in the restricted bands, as defined in§15.205(a), must also comply with the radiated emission limits specified in15.209(a).

9.2 TEST PROCEDURE

Using the following spectrum analyzer setting:

- A) Set the RBW = 100KHz.
- B) Set the VBW = 300KHz.
- C) Sweep time = auto couple.
- D) Detector function = peak.
- E) Trace mode = max hold.
- F) Allow trace to fully stabilize.

9.3 DEVIATION FROM STANDARD

No deviation.

9.4 TEST SETUP



9.5 EUT OPERATION CONDITIONS

The EUT tested system was configured as the statements of 2.4 Unless otherwise a special operating condition is specified in the follows during the testing.

9.6 TEST RESULTS



Test plot as follows:

Test mode: 802.11b



Lowest channel



Highest channel

Test mode: 802.11g



Lowest channel



Highest channel

Test mode: 802.11n(HT20)



Lowest channel

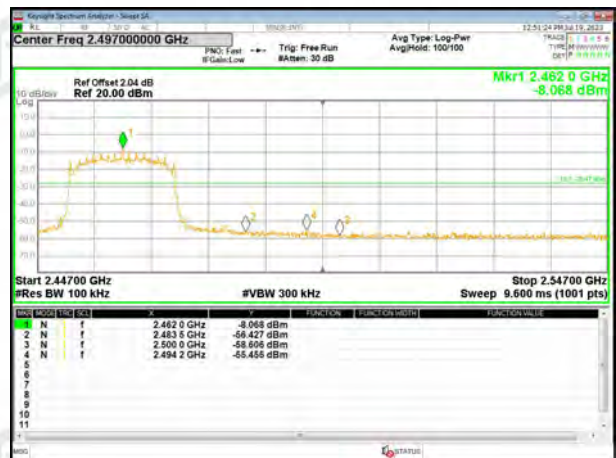

Highest channel



Test mode:

802.11n(HT40)



Lowest channel



Highest channel



Test plot as follows:

802.11b	802.11g
---------	---------

Lowest channel

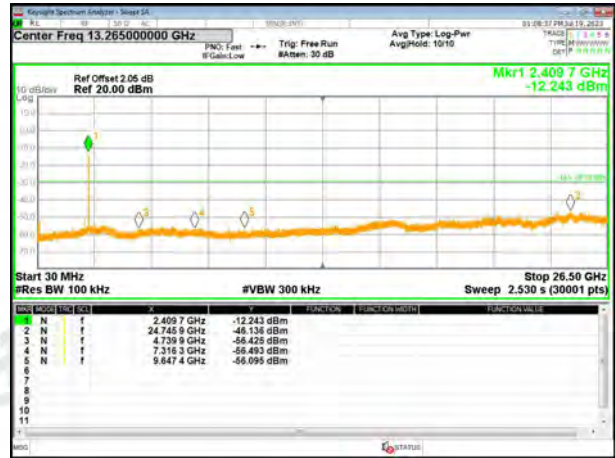

Middle channel

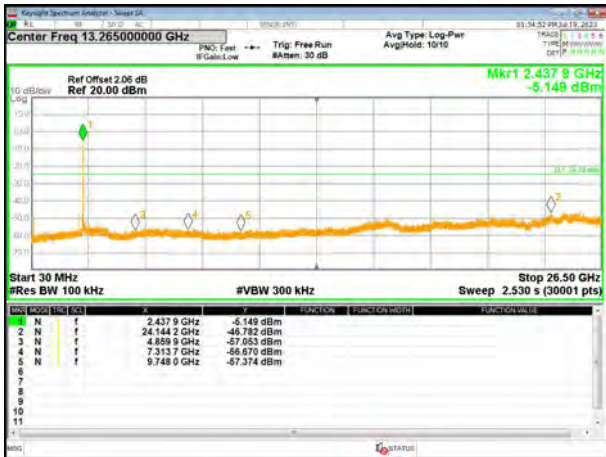

Highest channel

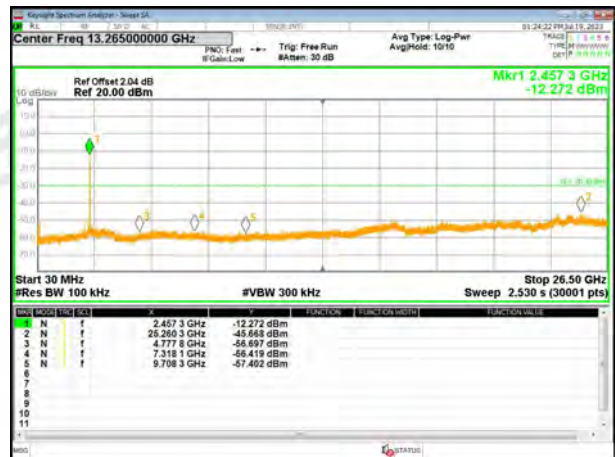
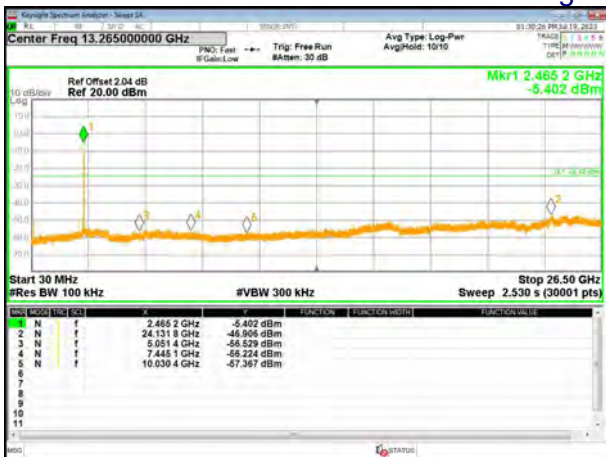



802.11n(HT20)

802.11n(HT40)

Lowest channel

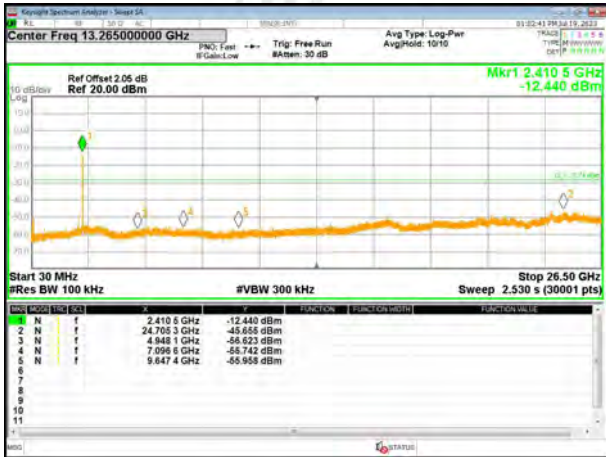

Middle channel



Highest channel

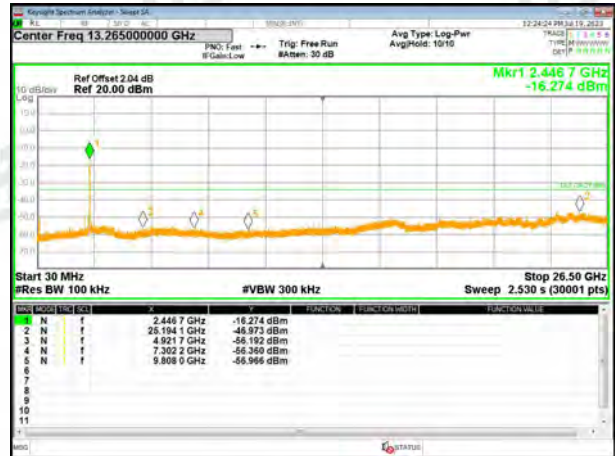
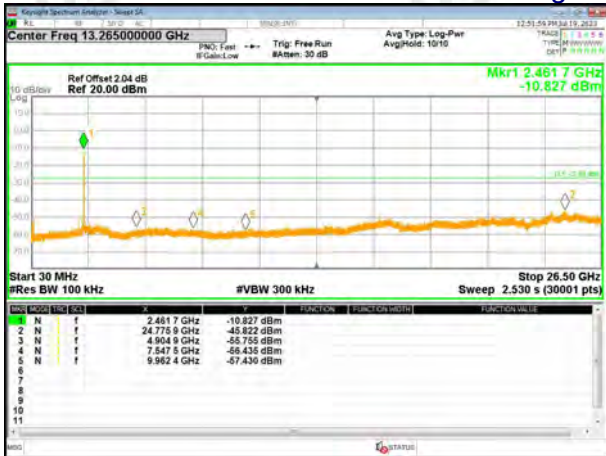



10. ANTENNA REQUIREMENT

Standard requirement:	FCC Part15 C Section 15.203 /247(b)(4)
<p>15.203 requirement: An intentional radiator shall be designed to ensure that no antenna other than that furnished by the responsible party shall be used with the device. The use of a permanently attached antenna or of an antenna that uses a unique coupling to the intentional radiator, the manufacturer may design the unit so that a broken antenna can be replaced by the user, but the use of a standard antenna jack or electrical connector is prohibited.</p> <p>15.247(b) (4) requirement: (4) The conducted output power limit specified in paragraph (b) of this section is based on the use of antennas with directional gains that do not exceed 6 dBi. Except as shown in paragraph (c) of this section, if transmitting antennas of directional gain greater than 6 dBi are used, the conducted output power from the intentional radiator shall be reduced below the stated values in paragraphs (b)(1), (b)(2), and (b)(3) of this section, as appropriate, by the amount in dB that the directional gain of the antenna exceeds 6 dBi.</p>	
EUT Antenna:	
The antenna is FPC Antenna, the best case gain of the antenna is 1.50 dBi, reference to the appendix II for details	



11. TEST SETUP PHOTO

Reference to the appendix I for details.

12. EUT CONSTRUCTIONAL DETAILS

Reference to the appendix II for details.

******* END OF REPORT *******