



## FCC TEST REPORT

### FCC ID: 2A3O9-LF500MS

**Report Number**..... : **ZKT-221221L9595E**

Date of Test..... Dec. 15, 2022 to Jan. 04, 2023

Date of issue..... : Jan. 04, 2023

Total number of pages..... 51

Test Result..... : PASS

**Testing Laboratory**..... : **Shenzhen ZKT Technology Co., Ltd.**

Address ..... : 1/F, No. 101, Building B, No. 6, Tangwei Community Industrial Avenue, Fuhai Street, Bao'an District, Shenzhen, China

**Applicant's name** ..... : **West Ryder Technology. LLC**

Address ..... :  
2330 Paseo Del Prado STE C304 Las Vegas, Las Vegas, NV 89102

**Manufacturer's name** ..... : **Oufa (Dongguan) Environmental Protection Technology Co., Ltd**

Address ..... :  
4th floor, Building B, Jie'an Industrial Park, Changping Town, Dongguan City

**Test specification:**

Standard..... : FCC CFR Title 47 Part 15 Subpart C Section 15.247

Test procedure..... : KDB558074 D01 15.247 Meas Guidance v05r02  
ANSI C63.10:2013

Non-standard test method ..... : N/A

**Test Report Form No**..... : TRF-EL-110\_V0

**Test Report Form(s) Originator**..... : ZKT Testing

**Master TRF** ..... : Dated: 2020-01-06

This device described above has been tested by ZKT, and the test results show that the equipment under test (EUT) is in compliance with the FCC requirements. And it is applicable only to the tested sample identified in the report.

This report shall not be reproduced except in full, without the written approval of ZKT, this document may be altered or revised by ZKT, personal only, and shall be noted in the revision of the document.

**Product name**..... : **Aroma Diffuser**

Trademark ..... : Airthereal

Model/Type reference..... : LF500MS

Ratings..... : Input: 100-240V~50/60Hz 1A  
Output: 24V= 1.5A, 36W



**Testing procedure and testing location:**

**Testing Laboratory**.....: **Shenzhen ZKT Technology Co., Ltd.**

**Address**.....: 1/F, No. 101, Building B, No. 6, Tangwei Community Industrial Avenue, Fuhai Street, Bao'an District, Shenzhen, China

**Tested by (name + signature)**.....: Jim Liu

**Reviewer (name + signature)**.....: Tom Zou

**Approved (name + signature)**.....: Lake Xie





## Table of Contents

	Page
<b>1. VERSION</b>	<b>5</b>
<b>2. SUMMARY OF TEST RESULTS</b>	<b>6</b>
2.1 TEST FACILITY	7
2.2 MEASUREMENT UNCERTAINTY	7
<b>3. GENERAL INFORMATION</b>	<b>8</b>
3.1 GENERAL DESCRIPTION OF EUT	8
3.2 DESCRIPTION OF TEST MODES	9
3.3 BLOCK DIGRAM SHOWING THE CONFIGURATION OF SYSTEM TESTED	10
3.4 DESCRIPTION OF SUPPORT UNITS(CONDUCTED MODE)	10
3.5EQUIPMENTS LIST FOR ALL TEST ITEMS	11
<b>4. EMC EMISSION TEST</b>	<b>13</b>
4.1 CONDUCTED EMISSION MEASUREMENT	13
4.1.1 POWER LINE CONDUCTED EMISSION LIMITS	13
4.1.2 TEST PROCEDURE	13
4.1.3 DEVIATION FROM TEST STANDARD	13
4.1.4 TEST SETUP	14
4.1.5 EUT OPERATING CONDITIONS	14
4.1.6 TEST RESULT	14
4.2 RADIATED EMISSION MEASUREMENT	17
4.2.1 RADIATED EMISSION LIMITS	17
4.2.2 TEST PROCEDURE	17
4.2.3 DEVIATION FROM TEST STANDARD	18
4.2.4 TEST SETUP	18
4.2.5 EUT OPERATING CONDITIONS	19
4.2.6 TEST RESULTS	19
<b>5.RADIATED BAND EMISSIONMEASUREMENT</b>	<b>29</b>
5.1 TEST REQUIREMENT:	29
5.2 TEST PROCEDURE	29
5.3 DEVIATION FROM TEST STANDARD	29
5.4 TEST SETUP	30
5.5 EUT OPERATING CONDITIONS	30
5.6 TEST RESULT	31
<b>6.POWER SPECTRAL DENSITY TEST</b>	<b>33</b>
6.1 APPLIED PROCEDURES / LIMIT	33
6.2 TEST PROCEDURE	33
6.3 DEVIATION FROM STANDARD	33
6.4 TEST SETUP	33



6.5 EUT OPERATION CONDITIONS	33
6.6 TEST RESULT	34
<b>7. CHANNEL BANDWIDTH&amp; 99% OCCUPY BANDWIDTH</b>	<b>40</b>
7.1 APPLIED PROCEDURES / LIMIT	40
7.2 TEST PROCEDURE	40
7.3 DEVIATION FROM STANDARD	40
7.4 TEST SETUP	40
7.5 EUT OPERATION CONDITIONS	40
7.6 TEST RESULT	41
<b>8.PEAK OUTPUT POWER TEST</b>	<b>44</b>
8.1 APPLIED PROCEDURES/LIMIT	44
8.2 TEST PROCEDURE	44
8.3 DEVIATION FROM STANDARD	44
8.4 TEST SETUP	44
8.5 EUT OPERATION CONDITIONS	44
8.6 TEST RESULT	45
<b>9. CONDUCTED BAND EDGE AND SPURIOUS EMISSION</b>	<b>46</b>
9.1 APPLICABLE STANDARD	46
9.2 TEST PROCEDURE	46
9.3 DEVIATION FROM STANDARD	46
9.4 TEST SETUP	46
9.5 EUT OPERATION CONDITIONS	46
9.6 TEST RESULTS	46
<b>10. ANTENNA REQUIREMENT</b>	<b>50</b>
<b>11. TEST SETUP PHOTO</b>	<b>51</b>
<b>12. EUT CONSTRUCTIONAL DETAILS</b>	<b>51</b>



**1. VERSION**

Report No.	Version	Description	Approved
ZKT-221221L9595E	Rev.01	Initial issue of report	Jan. 04, 2023



## 2. SUMMARY OF TEST RESULTS

Test procedures according to the technical standards:

FCC Part15 (15.247) , Subpart C			
Standard Section	Test Item	Result	Remark
FCC part 15.203/15.247 (b)(4)	Antenna requirement	PASS	
FCC part 15.207	AC Power Line Conducted Emission	PASS	
FCC part 15.247 (b)(3)	Conducted Peak Output Power	PASS	
FCC part 15.247 (a)(2)	Channel Bandwidth& 99% OCB	PASS	
FCC part 15.247 (e)	Power Spectral Density	PASS	
FCC part 15.247(d)	Band Edge	PASS	
FCC part 15.205/15.209	Spurious Emission	PASS	

NOTE:

(1)" N/A" denotes test is not applicable in this Test Report



## 2.1 TEST FACILITY

Shenzhen ZKT Technology Co., Ltd.  
Add. : 1/F, No. 101, Building B, No. 6, Tangwei Community Industrial Avenue, Fuhai Street, Bao'an District, Shenzhen, China

FCC Test Firm Registration Number: 692225  
Designation Number: CN1299  
IC Registered No.: 27033

## 2.2 MEASUREMENT UNCERTAINTY

The reported uncertainty of measurement  $y \pm U$  · where expanded uncertainty U is based on a standard uncertainty multiplied by a coverage factor of  $k=2$  · providing a level of confidence of approximately 95 % ·

No.	Item	Uncertainty
1	Conducted Emission Test	$\pm 1.38\text{dB}$
2	RF power conducted	$\pm 0.16\text{dB}$
3	Spurious emissions conducted	$\pm 0.21\text{dB}$
4	All emissions radiated(<1G)	$\pm 4.68\text{dB}$
5	All emissions radiated(>1G)	$\pm 4.89\text{dB}$
6	Temperature	$\pm 0.5^\circ\text{C}$
7	Humidity	$\pm 2\%$



### 3. GENERAL INFORMATION

#### 3.1 GENERAL DESCRIPTION OF EUT

Product Name:	Aroma Diffuser
Model No.:	LF500MS
Model Different.:	N/A
Hardware Version:	V1.0
Software Version:	V1.0
Sample(s) Status:	Engineer sample
Channel numbers:	802.11b/802.11g /802.11n(HT20):11
Operation Frequency:	802.11b/802.11g /802.11n(HT20): 2412-2462MHz
Channel separation:	5MHz
Modulation technology:	IEEE 802.11b: DQPSK/DBPSK/DSSS/CCK IEEE 802.11g: QPSK/BPSK/16QAM/64QAM/OFDM IEEE 802.11n: QPSK/BPSK/16QAM/64QAM/OFDM
Antenna Type:	PCB Antenna
Antenna gain:	2.54dBi
Power supply:	Input: 100-240V~50/60Hz 1A Output: 24V--- 1.5A, 36W





Operation Frequency each of channel							
Channel	Frequency	Chann el	Frequency	Chann el	Frequency	Chann el	Frequency
1	2412MHz	4	2427MHz	7	2442MHz	10	2457MHz
2	2417MHz	5	2432MHz	8	2447MHz	11	2462MHz
3	2422MHz	6	2437MHz	9	2452MHz	X	

Note:

In section 15.31(m), regards to the operating frequency range over 10 MHz, the Lowest frequency, the middle frequency, and the highest frequency of channel were selected to perform the test, and the selected channel see below:

Test channel	Frequency (MHz)
	802.11b/802.11g/802.11n(HT20)
Lowest channel	2412MHz
Middle channel	2437MHz
Highest channel	2462MHz

### 3.2 DESCRIPTION OF TEST MODES

Transmitting mode	Keep the EUT in continuously transmitting mode
Remark: EUT use new battery during the test, the duty cycle >98%, the test voltage was tuned from 85% to 115% of the nominal rated supply voltage, and found that the worst case was under the nominal rated supply condition. So the report just shows that condition's data.	

We have verified the construction and function in typical operation. All the test modes were carried out with the EUT in transmitting operation, which was shown in this test report and defined as follows:			
Pre-scan all kind of data rate in lowest channel, and found the follow list which it was worst case.			
Mode	802.11b	802.11g	802.11n(HT20)
Data rate	1Mbps	6Mbps	6.5Mbps



### 3.3 BLOCK DIGRAM SHOWING THE CONFIGURATION OF SYSTEM TESTED

Radiated Emission



Conducted Spurious



### 3.4 DESCRIPTION OF SUPPORT UNITS(CONDUCTED MODE)

The EUT has been tested as an independent unit together with other necessary accessories or support units. The following support units or accessories were used to form a representative test configuration during the tests.

Item	Equipment	Mfr/Brand	Model/Type No.	Series No.	Note
E-1	Aroma Diffuser	N/A	LF500MS	N/A	EUT
E-2	Adapter	N/A	GA240015	N/A	EUT

Item	Shielded Type	Ferrite Core	Length	Note

Note:

- (1) The support equipment was authorized by Declaration of Confirmation.
- (2) For detachable type I/O cable should be specified the length in cm in 『Length』 column.



## 3.5EQUIPMENTS LIST FOR ALL TEST ITEMS

## Radiation Test equipment

Item	Equipment	Manufacturer	Type No.	Serial No.	Last calibration	Calibrated until
1	Spectrum Analyzer (9kHz-26.5GHz)	KEYSIGHT	9020A	MY55370835	Oct. 28, 2022	Oct. 27, 2023
2	Spectrum Analyzer (10kHz-39.9GHz)	R&S	FSQ	100363	Oct. 28, 2022	Oct. 27, 2023
3	EMI Test Receiver (9kHz-7GHz)	R&S	ESCI7	101169	Oct. 28, 2022	Oct. 27, 2023
4	Bilog Antenna (30MHz-1500MHz)	Schwarzbeck	VULB9168	N/A	Nov. 02, 2022	Nov. 01, 2023
5	Horn Antenna (1GHz-18GHz)	Agilent	AH-118	071145	Nov. 01, 2022	Oct. 31, 2023
6	Horn Antenna (15GHz-40GHz)	A.H.System	SAS-574	588	Oct. 28, 2022	Oct. 27, 2023
7	Loop Antenna	TESEQ	HLA6121	58357	Nov. 01, 2022	Oct. 31, 2023
8	Amplifier (30-1000MHz)	EM Electronics	EM330 Amplifier	060747	Nov. 15, 2022	Nov. 14, 2023
9	Amplifier (1GHz-26.5GHz)	Agilent	8449B	3008A00315	Oct. 28, 2022	Oct. 27, 2023
10	Amplifier (500MHz-40GHz)	QuanJuDa	DLE-161	097	Oct. 28, 2022	Oct. 27, 2023
11	Test Cable	N/A	R-01	N/A	Oct. 28, 2022	Oct. 27, 2023
12	Test Cable	N/A	R-02	N/A	Oct. 28, 2022	Oct. 27, 2023
13	Test Cable	N/A	R-03	N/A	Oct. 28, 2022	Oct. 27, 2023
14	Test Cable	N/A	RF-01	N/A	Oct. 28, 2022	Oct. 27, 2023
15	Test Cable	N/A	RF-02	N/A	Oct. 28, 2022	Oct. 27, 2023
16	Test Cable	N/A	RF-03	N/A	Oct. 28, 2022	Oct. 27, 2023
17	ESG Signal Generator	Agilent	E4421B	N/A	Oct. 21, 2022	Oct. 20, 2023
18	Signal Generator	Agilent	N5182A	N/A	Oct. 21, 2022	Oct. 20, 2023
19	Magnetic Field Probe Tester	Narda	ELT-400	0-0344	Nov. 15, 2022	Nov. 14, 2023
20	Wideband Radio Communication Test	R&S	CMW500	106504	Oct. 28, 2022	Oct. 27, 2023
21	MWRF Power Meter Test system	MW	MW100-RPCB	N/A	Oct. 21, 2022	Oct. 20, 2023
22	D.C. Power Supply	LongWei	TPR-6405D	N/A	\	\
23	EMC Software	Frad	EZ-EMC	Ver.EMC-CON 3A1.1	\	\
24	RF Software	MW	MTS8310	V2.0.0.0	\	\
25	Turntable	MF	MF-7802BS	N/A	\	\
26	Antenna tower	MF	MF-7802BS	N/A	\	\



## Conduction Test equipment

Item	Kind of Equipment	Manufacturer	Type No.	Serial No.	Last calibration	Calibrated until
1	LISN	R&S	ENV216	101471	Oct. 21, 2022	Oct. 20, 2023
2	LISN	CYBERTEK	EM5040A	E1850400149	Oct. 21, 2022	Oct. 20, 2023
3	Test Cable	N/A	C-01	N/A	Oct. 21, 2022	Oct. 20, 2023
4	Test Cable	N/A	C-02	N/A	Oct. 21, 2022	Oct. 20, 2023
5	Test Cable	N/A	C-03	N/A	Oct. 21, 2022	Oct. 20, 2023
6	EMI Test Receiver	R&S	ESCI3	101393	Oct. 28, 2022	Oct. 27, 2023
7	EMC Software	Frad	EZ-EMC	Ver.EMC-CO N 3A1.1	\	\



## 4. EMC EMISSION TEST

### 4.1 CONDUCTED EMISSION MEASUREMENT

Test Requirement:	FCC Part15 C Section 15.207
Test Method:	ANSI C63.10:2013
Test Frequency Range:	150KHz to 30MHz
Receiver setup:	RBW=9KHz, VBW=30KHz, Sweep time=auto

#### 4.1.1 POWER LINE CONDUCTED EMISSION Limits

FREQUENCY (MHz)	Limit (dBuV)		Standard
	Quasi-peak	Average	
0.15 -0.5	66 - 56 *	56 - 46 *	FCC
0.50 -5.0	56.00	46.00	FCC
5.0 -30.0	60.00	50.00	FCC

Note:

(1) \*Decreases with the logarithm of the frequency.

#### 4.1.2 TEST PROCEDURE

- The EUT was placed 0.1 meters from the horizontal ground plane with EUT being connected to the power mains through a line impedance stabilization network (LISN). All other support equipments powered from additional LISN(s). The LISN provide 50 Ohm/ 50uH of coupling impedance for the measuring instrument.
- Interconnecting cables that hang closer than 40 cm to the ground plane shall be folded back and forth in the center forming a bundle 30 to 40 cm long.
- I/O cables that are not connected to a peripheral shall be bundled in the center. The end of the cable may be terminated, if required, using the correct terminating impedance. The overall length shall not exceed 1 m.
- LISN at least 80 cm from nearest part of EUT chassis.
- For the actual test configuration, please refer to the related Item –EUT Test Photos.

#### 4.1.3 DEVIATION FROM TEST STANDARD

No deviation



#### 4.1.4 TEST SETUP

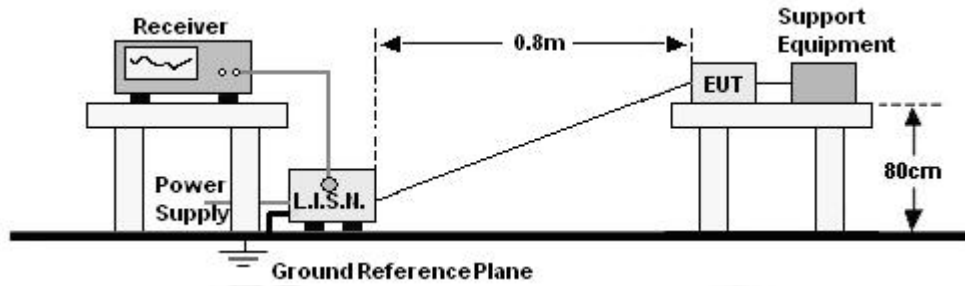

#### 4.1.5 EUT OPERATING CONDITIONS

The EUT was configured for testing in a typical fashion (as a customer would normally use it). The EUT has been programmed to continuously transmit during test. This operating condition was tested and used to collect the included data.



## 4.1.6 test result

Temperature:	25.1°C	Relative Humidity :	50%
Pressure:	101kPa	Phase :	L
Test Voltage:	AC 120V/60Hz		

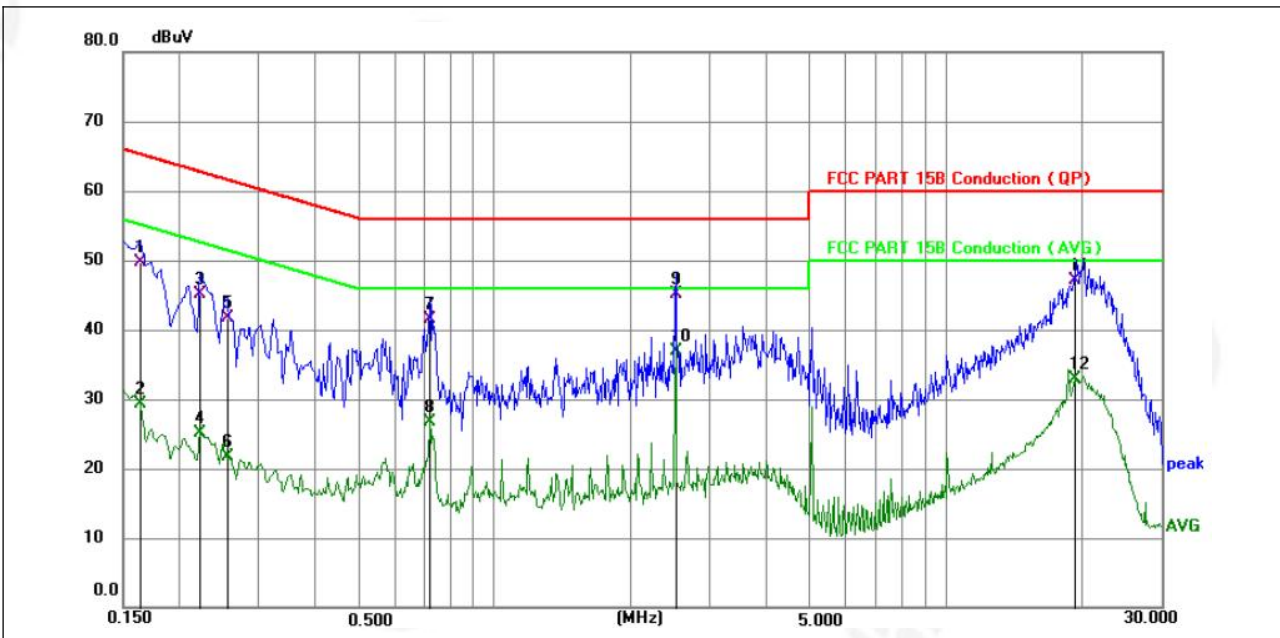

No.	Frequency (MHz)	Reading (dBuV)	Factor (dB)	Level (dBuV)	Limit (dBuV)	Margin (dB)	Detector	P/F
1	0.1632	39.86	9.90	49.76	65.30	-15.54	QP	P
2	0.1632	19.46	9.90	29.36	55.30	-25.94	AVG	P
3	0.2220	35.21	9.92	45.13	62.74	-17.61	QP	P
4	0.2220	15.19	9.92	25.11	52.74	-27.63	AVG	P
5	0.2535	31.83	9.93	41.76	61.64	-19.88	QP	P
6	0.2535	11.78	9.93	21.71	51.64	-29.93	AVG	P
7	0.7170	31.37	10.04	41.41	56.00	-14.59	QP	P
8	0.7170	16.75	10.04	26.79	46.00	-19.21	AVG	P
9	2.5170	34.97	10.06	45.03	56.00	-10.97	QP	P
10 *	2.5170	26.77	10.06	36.83	46.00	-9.17	AVG	P
11	19.4639	36.99	10.11	47.10	60.00	-12.90	QP	P
12	19.4639	22.70	10.11	32.81	50.00	-17.19	AVG	P

## Notes:

1. An initial pre-scan was performed on the line and neutral lines with peak detector.
2. Quasi-Peak and Average measurement were performed at the frequencies with maximized peak emission.
3. Measurement Level = Reading level + Correct Factor



Temperature:	25.1°C	Relative Humidity :	50%
Pressure:	101kPa	Phase :	N
Test Voltage:	AC 120V/60Hz		

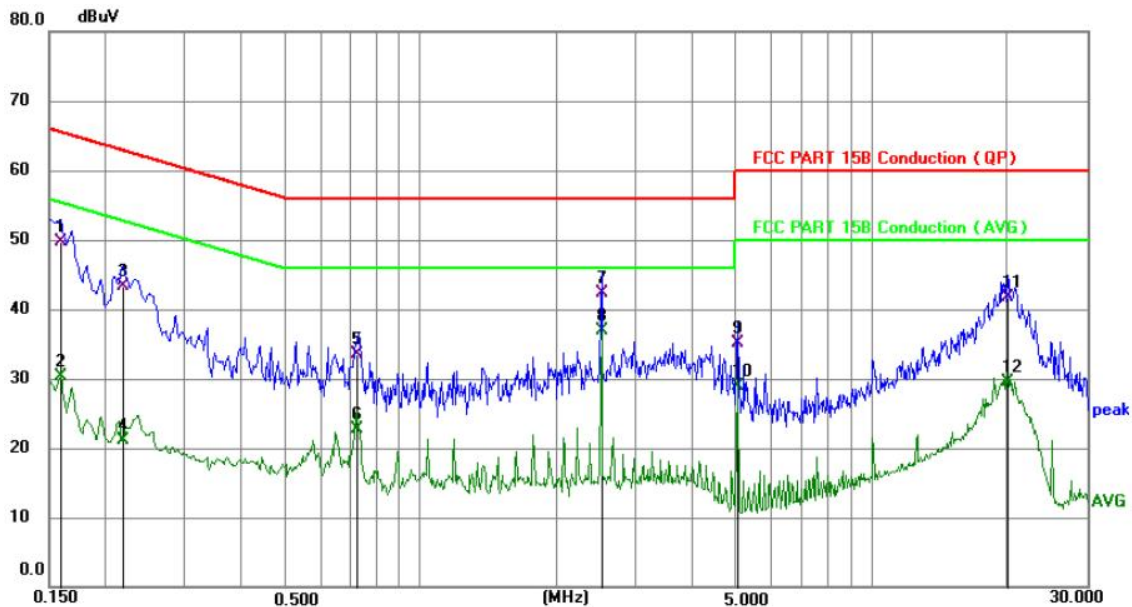

No.	Frequency (MHz)	Reading (dBuV)	Factor (dB)	Level (dBuV)	Limit (dBuV)	Margin (dB)	Detector	P/F
1	0.1590	39.89	9.89	49.78	65.52	-15.74	QP	P
2	0.1590	20.45	9.89	30.34	55.52	-25.18	AVG	P
3	0.2175	33.43	9.92	43.35	62.91	-19.56	QP	P
4	0.2175	11.10	9.92	21.02	52.91	-31.89	AVG	P
5	0.7304	23.37	10.04	33.41	56.00	-22.59	QP	P
6	0.7304	12.64	10.04	22.68	46.00	-23.32	AVG	P
7	2.5170	32.24	10.06	42.30	56.00	-13.70	QP	P
8 *	2.5170	26.76	10.06	36.82	46.00	-9.18	AVG	P
9	5.0324	25.02	10.12	35.14	60.00	-24.86	QP	P
10	5.0324	18.77	10.12	28.89	50.00	-21.11	AVG	P
11	20.0355	31.54	10.11	41.65	60.00	-18.35	QP	P
12	20.0355	19.37	10.11	29.48	50.00	-20.52	AVG	P

## Notes:

1. An initial pre-scan was performed on the line and neutral lines with peak detector.
2. Quasi-Peak and Average measurement were performed at the frequencies with maximized peak emission.
3. Measurement Level = Reading level + Correct Factor





## 4.2 RADIATED EMISSION MEASUREMENT

Test Requirement:	FCC Part15 C Section 15.209				
Test Method:	ANSI C63.10:2013				
Test Frequency Range:	9kHz to 25GHz				
Test site:	Measurement Distance: 3m				
Receiver setup:	Frequency	Detector	RBW	VBW	Value
	9KHz-150KHz	Quasi-peak	200Hz	600Hz	Quasi-peak
	150KHz-30MHz	Quasi-peak	9KHz	30KHz	Quasi-peak
	30MHz-1GHz	Quasi-peak	100KHz	300KHz	Quasi-peak
	Above 1GHz	Peak	1MHz	3MHz	Peak
Peak		1MHz	10Hz	Average	

## 4.2.1 RADIATED EMISSION LIMITS

Frequencies (MHz)	Field Strength (micorvolts/meter)	Measurement Distance (meters)
0.009~0.490	2400/F(KHz)	300
0.490~1.705	24000/F(KHz)	30
1.705~30.0	30	30
30~88	100	3
88~216	150	3
216~960	200	3
Above 960	500	3

## LIMITS OF RADIATED EMISSION MEASUREMENT

FREQUENCY (MHz)	Limit (dBuV/m) (at 3M)	
	PEAK	AVERAGE
Above 1000	74	54

Notes:

- (1) The limit for radiated test was performed according to FCC PART 15C.
- (2) The tighter limit applies at the band edges.
- (3) Emission level (dBuV/m)=20log Emission level (uV/m).

## 4.2.2 TEST PROCEDURE

Below 1GHz test procedure as below:

- a. The EUT was placed on the top of a rotating table 0.8 meters above the ground at a 3 meter semi-anechoiccamber. The table was rotated 360 degrees to determine the position of the highest radiation.
- b. The EUT was set 3 meters away from the interference-receiving antenna, which was mounted on the top of variable-height antenna tower.



- c. The antenna height is varied from one meter to four meters above the ground to determine the maximum value of the field strength. Both horizontal and vertical polarizations of the antenna are set to make the measurement.
- d. For each suspected emission, the EUT was arranged to its worst case and then the antenna was tuned to heights from 1 meter to 4 meters (for the test frequency of below 30MHz, the antenna was tuned to heights 1meter) and the rotatable table was turned from 0 degrees to 360 degrees to find the maximum reading.
- e. The test-receiver system was set to Peak Detect Function and Specified Bandwidth with Maximum Hold Mode.
- f. If the emission level of the EUT in peak mode was 10dB lower than the limit specified, then testing could be stopped and the peak values of the EUT would be reported. Otherwise the emissions that did not have 10dBmargin would be re-tested one by one using peak, quasi-peak or average method as specified and then reported in a data sheet.

Above 1GHz test procedure as below:

- g. Different between above is the test site, change from Semi- Anechoic Chamber to fully Anechoic Chamber and change form table 0.8 meter to 1.5 meter( Above 18GHz the distance is 1 meter and table is 1.5 meter).
- h. Test the EUT in the lowest channel ,the middle channel ,the Highest channel

Note:

Both horizontal and vertical antenna polarities were tested and performed pretest to three orthogonal axis. The worst case emissions were reported

#### 4.2.3 DEVIATION FROM TEST STANDARD

No deviation

#### 4.2.4 TEST SETUP

(A) Radiated Emission Test-Up Frequency Below 30MHz

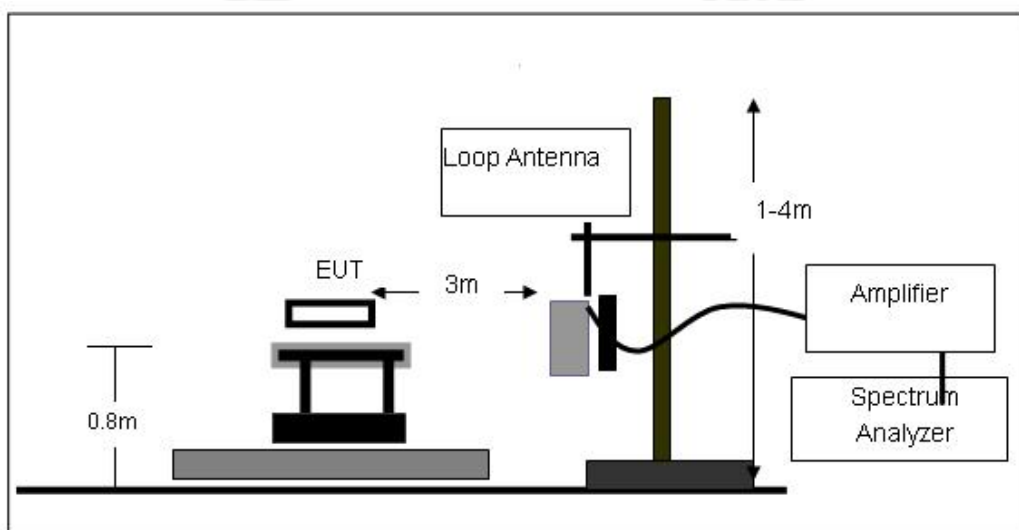



(B) Radiated Emission Test-Up Frequency 30MHz~1GHz

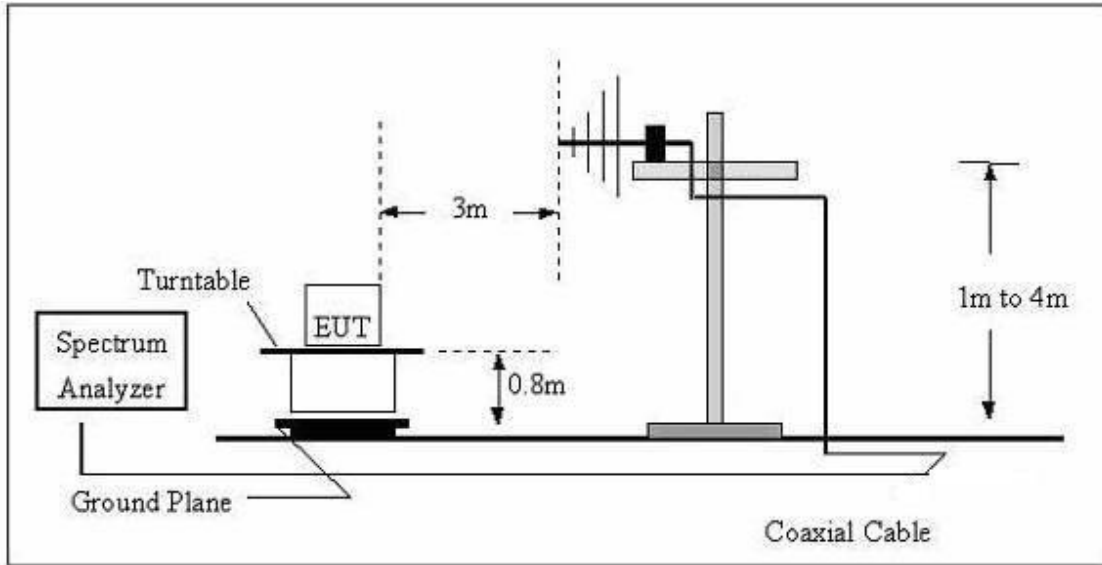

(C) Radiated Emission Test-Up Frequency Above 1GHz

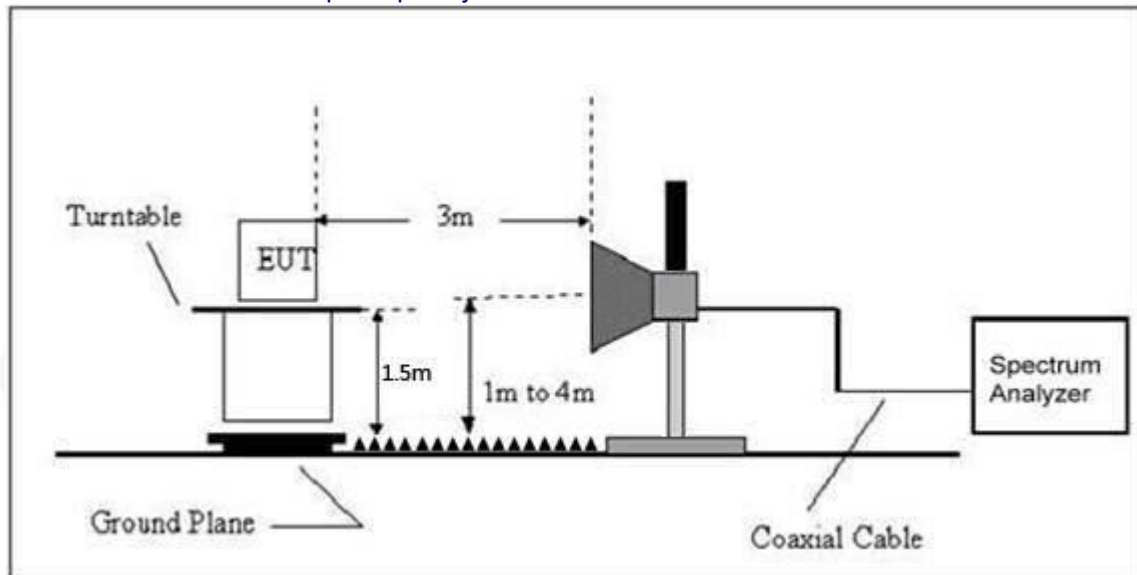

4.2.5 EUT OPERATING CONDITIONS

The EUT tested system was configured as the statements of 2.4 Unless otherwise a special operating condition is specified in the follows during the testing.

4.2.6 TEST RESULTS

Between 9KHz – 30MHz

The emission from 9 kHz to 30MHz was pre-tested and found the result was 20dB lower than the limit, and according to 15.31(o) & RSS-Gen 6.13, the test result no need to reported.



Between 30MHz – 1GHz

Temperature:	25.1°C	Relative Humidity :	50%
Pressure:	101kPa	Polarization:	Horizontal
Test Voltage:	AC 120V/60Hz		

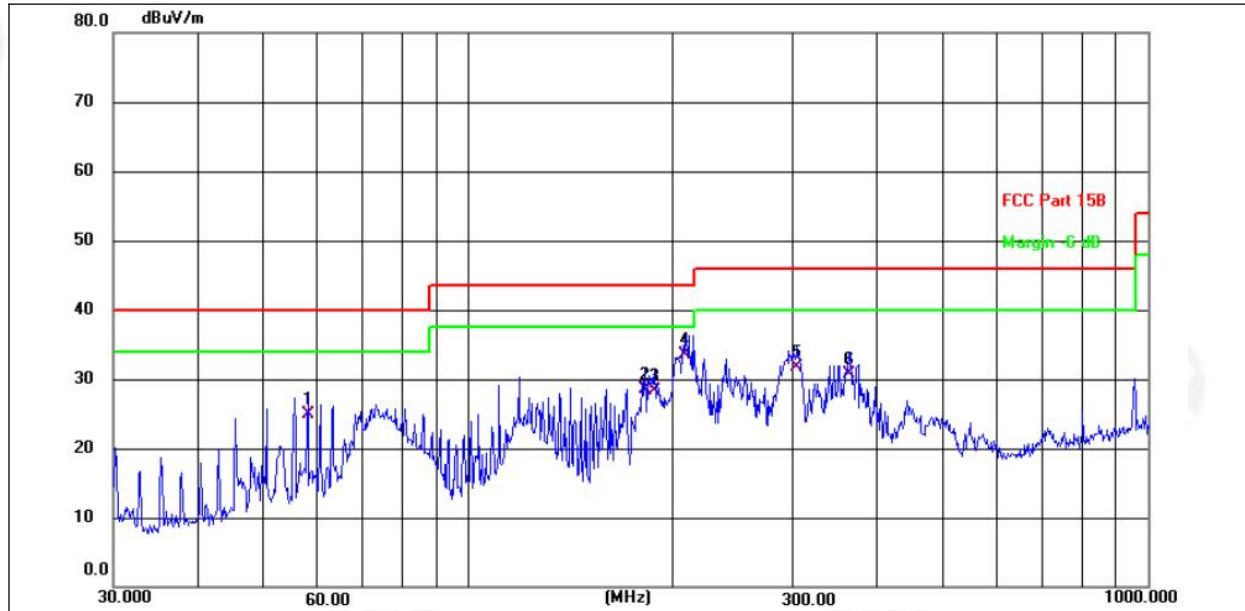

No.	Frequency (MHz)	Reading (dBuV)	Factor (dB/m)	Level (dBuV/m)	Limit (dBuV/m)	Margin (dB)	Detector
1	57.9993	40.42	-15.48	24.94	40.00	-15.06	QP
2	181.9202	46.54	-18.09	28.45	43.50	-15.05	QP
3	187.7530	45.86	-17.64	28.22	43.50	-15.28	QP
4 *	209.3129	49.81	-16.36	33.45	43.50	-10.05	QP
5	304.6099	45.58	-13.84	31.74	46.00	-14.26	QP
6	362.9844	43.27	-12.50	30.77	46.00	-15.23	QP



Temperature:	25.1°C	Relative Humidity :	50%
Pressure:	101kPa	Polarization:	Vertical
Test Voltage:	AC 120V/60Hz		

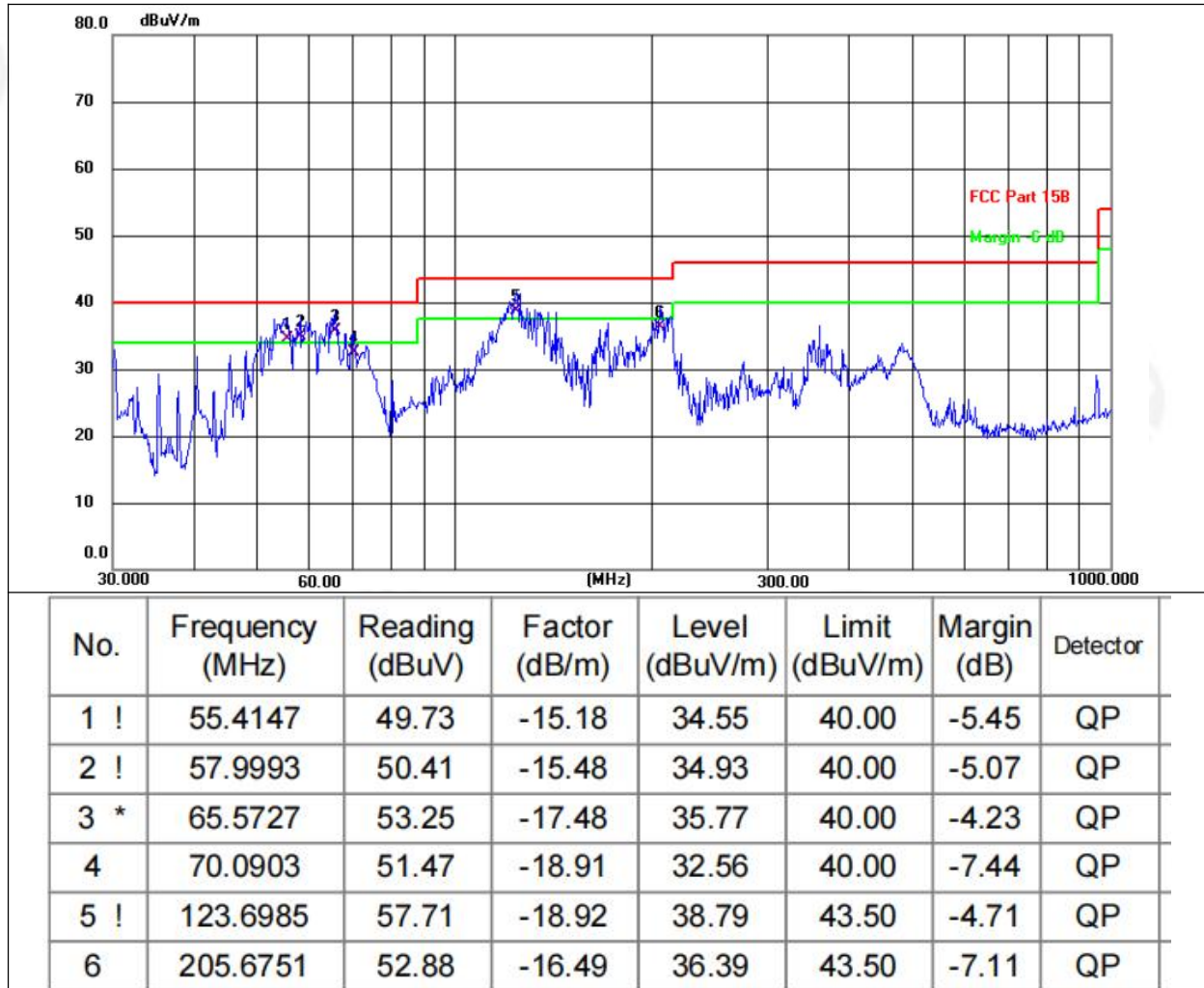

## Remarks:

1. Final Level = Receiver Read level + Antenna Factor + Cable Loss – Preamplifier Factor
2. The emission levels of other frequencies are very lower than the limit and not show in test report.
3. The test data shows only the worst case 802.11b mode ( Low Channel:2412MHz ).



1GHz~25GHz

802.11b

Polar (H/V)	Frequency	Meter Reading	Pre-ampl ifier	Cable Loss	Antenna Factor	Emission Level	Limits	Margin	Detect or Type
	(MHz)	(dBuV)	(dB)	(dB)	(dB)	(dBuV/m)	(dBuV/ m)	(dB)	
Low Channel:2412MHz									
V	4824.00	60.60	30.55	5.77	24.66	60.48	74	-13.52	PK
V	4824.00	43.55	30.55	5.77	24.66	43.43	54	-10.57	AV
V	7236.00	53.98	30.33	6.32	24.55	54.52	74	-19.48	PK
V	7236.00	37.07	30.33	6.32	24.55	37.61	54	-16.39	AV
V	9648.00	51.38	30.85	7.45	24.69	52.67	74	-21.33	PK
V	9648.00	34.86	30.85	7.45	24.69	36.15	54	-17.85	AV
V	12060.00	56.41	31.02	8.99	25.57	59.95	74	-14.05	PK
V	12060.00	38.64	31.02	8.99	25.57	42.18	54	-11.82	AV
H	4824.00	54.06	30.55	5.77	24.66	53.94	74	-20.06	PK
H	4824.00	37.29	30.55	5.77	24.66	37.17	54	-16.83	AV
H	7236.00	51.65	30.33	6.32	24.55	52.19	74	-21.81	PK
H	7236.00	35.96	30.33	6.32	24.55	36.5	54	-17.5	AV
H	9648.00	48.95	30.85	7.45	24.69	50.24	74	-23.76	PK
H	9648.00	35.38	30.85	7.45	24.69	36.67	54	-17.33	AV
H	12060.00	47.16	31.02	8.99	25.57	50.7	74	-23.3	PK
H	12060.00	33.24	31.02	8.99	25.57	36.78	54	-17.22	AV

Polar (H/V)	Frequency	Meter Reading	Pre-ampl ifier	Cable Loss	Antenna Factor	Emission Level	Limits	Margin	Detect or Type
	(MHz)	(dBuV)	(dB)	(dB)	(dB)	(dBuV/m)	(dBuV/ m)	(dB)	
Middle Channel:2437MHz									
V	4874.00	60.61	30.55	5.77	24.66	60.49	74	-13.51	PK
V	4874.00	42.68	30.55	5.77	24.66	42.56	54	-11.44	AV
V	7311.00	53.13	30.33	6.32	24.55	53.67	74	-20.33	PK
V	7311.00	37.13	30.33	6.32	24.55	37.67	54	-16.33	AV
V	9748.00	51.64	30.85	7.45	24.69	52.93	74	-21.07	PK
V	9748.00	35.03	30.85	7.45	24.69	36.32	54	-17.68	AV
V	12185.00	56.28	31.02	8.99	25.57	59.82	74	-14.18	PK
V	12185.00	38.19	31.02	8.99	25.57	41.73	54	-12.27	AV
H	4874.00	53.74	30.55	5.77	24.66	53.62	74	-20.38	PK
H	4874.00	37.51	30.55	5.77	24.66	37.39	54	-16.61	AV
H	7311.00	51.15	30.33	6.32	24.55	51.69	74	-22.31	PK
H	7311.00	35.66	30.33	6.32	24.55	36.2	54	-17.8	AV
H	9748.00	49.12	30.85	7.45	24.69	50.41	74	-23.59	PK
H	9748.00	35.36	30.85	7.45	24.69	36.65	54	-17.35	AV
H	12185.00	47.41	31.02	8.99	25.57	50.95	74	-23.05	PK
H	12185.00	33.50	31.02	8.99	25.57	37.04	54	-16.96	AV



Polar (H/V)	Frequency	Meter Reading	Pre-ampli fier	Cable Loss	Antenna Factor	Emission Level	Limits	Margin	Detect or Type
	(MHz)	(dBuV)	(dB)	(dB)	(dB)	(dBuV/m)	(dBuV/ m)	(dB)	
High Channel:2462MHz									
V	4924.00	62.14	30.55	5.77	24.66	62.02	74	-11.98	PK
V	4924.00	43.28	30.55	5.77	24.66	43.16	54	-10.84	AV
V	7386.00	53.83	30.33	6.32	24.55	54.37	74	-19.63	PK
V	7386.00	37.18	30.33	6.32	24.55	37.72	54	-16.28	AV
V	9848.00	51.08	30.85	7.45	24.69	52.37	74	-21.63	PK
V	9848.00	35.74	30.85	7.45	24.69	37.03	54	-16.97	AV
V	12310.00	56.26	31.02	8.99	25.57	59.8	74	-14.2	PK
V	12310.00	38.51	31.02	8.99	25.57	42.05	54	-11.95	AV
H	4924.00	53.64	30.55	5.77	24.66	53.52	74	-20.48	PK
H	4924.00	37.31	30.55	5.77	24.66	37.19	54	-16.81	AV
H	7386.00	50.89	30.33	6.32	24.55	51.43	74	-22.57	PK
H	7386.00	36.12	30.33	6.32	24.55	36.66	54	-17.34	AV
H	9848.00	49.38	30.85	7.45	24.69	50.67	74	-23.33	PK
H	9848.00	34.64	30.85	7.45	24.69	35.93	54	-18.07	AV
H	12310.00	47.53	31.02	8.99	25.57	51.07	74	-22.93	PK
H	12310.00	33.03	31.02	8.99	25.57	36.57	54	-17.43	AV

## Remark:

1. Emission Level = Meter Reading + Antenna Factor + Cable Loss – Pre-amplifier,

Margin= Emission Level - Limit

2. If peak below the average limit, the average emission was no test.

3. The amplitude of spurious emissions which are attenuated by more than 20dB below the permissible value has no need to be reported.



## 802.11g

Polar (H/V)	Frequency	Meter Reading	Pre-amplifier	Cable Loss	Antenna Factor	Emission Level	Limits	Margin	Detect or Type
	(MHz)	(dBuV)	(dB)	(dB)	(dB)	(dBuV/m)	(dBuV/m)	(dB)	
Low Channel:2412MHz									
V	4824.00	60.47	30.55	5.77	24.66	60.35	74	-13.65	PK
V	4824.00	42.85	30.55	5.77	24.66	42.73	54	-11.27	AV
V	7236.00	53.35	30.33	6.32	24.55	53.89	74	-20.11	PK
V	7236.00	37.02	30.33	6.32	24.55	37.56	54	-16.44	AV
V	9648.00	51.96	30.85	7.45	24.69	53.25	74	-20.75	PK
V	9648.00	35.15	30.85	7.45	24.69	36.44	54	-17.56	AV
V	12060.00	56.47	31.02	8.99	25.57	60.01	74	-13.99	PK
V	12060.00	38.42	31.02	8.99	25.57	41.96	54	-12.04	AV
H	4824.00	54.18	30.55	5.77	24.66	54.06	74	-19.94	PK
H	4824.00	37.06	30.55	5.77	24.66	36.94	54	-17.06	AV
H	7236.00	51.21	30.33	6.32	24.55	51.75	74	-22.25	PK
H	7236.00	36.08	30.33	6.32	24.55	36.62	54	-17.38	AV
H	9648.00	49.41	30.85	7.45	24.69	50.7	74	-23.3	PK
H	9648.00	35.35	30.85	7.45	24.69	36.64	54	-17.36	AV
H	12060.00	47.22	31.02	8.99	25.57	50.76	74	-23.24	PK
H	12060.00	33.19	31.02	8.99	25.57	36.73	54	-17.27	AV

Polar (H/V)	Frequency	Meter Reading	Pre-amplifier	Cable Loss	Antenna Factor	Emission Level	Limits	Margin	Detect or Type
	(MHz)	(dBuV)	(dB)	(dB)	(dB)	(dBuV/m)	(dBuV/m)	(dB)	
Middle Channel:2437MHz									
V	4874.00	60.33	30.55	5.77	24.66	60.21	74	-13.79	PK
V	4874.00	43.35	30.55	5.77	24.66	43.23	54	-10.77	AV
V	7311.00	53.26	30.33	6.32	24.55	53.8	74	-20.2	PK
V	7311.00	36.80	30.33	6.32	24.55	37.34	54	-16.66	AV
V	9748.00	51.95	30.85	7.45	24.69	53.24	74	-20.76	PK
V	9748.00	34.94	30.85	7.45	24.69	36.23	54	-17.77	AV
V	12185.00	55.91	31.02	8.99	25.57	59.45	74	-14.55	PK
V	12185.00	38.81	31.02	8.99	25.57	42.35	54	-11.65	AV
H	4874.00	54.33	30.55	5.77	24.66	54.21	74	-19.79	PK
H	4874.00	37.34	30.55	5.77	24.66	37.22	54	-16.78	AV
H	7311.00	50.87	30.33	6.32	24.55	51.41	74	-22.59	PK
H	7311.00	36.41	30.33	6.32	24.55	36.95	54	-17.05	AV
H	9748.00	49.25	30.85	7.45	24.69	50.54	74	-23.46	PK
H	9748.00	35.39	30.85	7.45	24.69	36.68	54	-17.32	AV
H	12185.00	46.96	31.02	8.99	25.57	50.5	74	-23.5	PK
H	12185.00	32.92	31.02	8.99	25.57	36.46	54	-17.54	AV





Polar (H/V)	Frequency	Meter Reading	Pre-ampl ifier	Cable Loss	Antenna Factor	Emission Level	Limits	Margin	Detect or Type
	(MHz)	(dBuV)	(dB)	(dB)	(dB)	(dBuV/m)	(dBuV/ m)	(dB)	
High Channel:2462MHz									
V	4924.00	61.73	30.55	5.77	24.66	61.61	74	-12.39	PK
V	4924.00	43.29	30.55	5.77	24.66	43.17	54	-10.83	AV
V	7386.00	53.36	30.33	6.32	24.55	53.9	74	-20.1	PK
V	7386.00	37.11	30.33	6.32	24.55	37.65	54	-16.35	AV
V	9848.00	51.55	30.85	7.45	24.69	52.84	74	-21.16	PK
V	9848.00	34.85	30.85	7.45	24.69	36.14	54	-17.86	AV
V	12310.00	55.97	31.02	8.99	25.57	59.51	74	-14.49	PK
V	12310.00	38.14	31.02	8.99	25.57	41.68	54	-12.32	AV
H	4924.00	53.62	30.55	5.77	24.66	53.5	74	-20.5	PK
H	4924.00	37.25	30.55	5.77	24.66	37.13	54	-16.87	AV
H	7386.00	50.73	30.33	6.32	24.55	51.27	74	-22.73	PK
H	7386.00	35.69	30.33	6.32	24.55	36.23	54	-17.77	AV
H	9848.00	48.91	30.85	7.45	24.69	50.2	74	-23.8	PK
H	9848.00	34.66	30.85	7.45	24.69	35.95	54	-18.05	AV
H	12310.00	47.51	31.02	8.99	25.57	51.05	74	-22.95	PK
H	12310.00	32.71	31.02	8.99	25.57	36.25	54	-17.75	AV

## Remark:

1. Emission Level = Meter Reading + Antenna Factor + Cable Loss – Pre-amplifier,

Margin= Emission Level - Limit

2. If peak below the average limit, the average emission was no test.

3. The amplitude of spurious emissions which are attenuated by more than 20dB below the permissible value has no need to be reported.



## 802.11n20

Polar (H/V)	Frequency	Meter Reading	Pre-ampl ifier	Cable Loss	Antenna Factor	Emission Level	Limits	Margin	Detect or Type
	(MHz)	(dBuV)	(dB)	(dB)	(dB)	(dBuV/m)	(dBuV/ m)	(dB)	
Low Channel:2412MHz									
V	4824.00	60.07	30.55	5.77	24.66	59.95	74	-14.05	PK
V	4824.00	42.97	30.55	5.77	24.66	42.85	54	-11.15	AV
V	7236.00	53.20	30.33	6.32	24.55	53.74	74	-20.26	PK
V	7236.00	37.17	30.33	6.32	24.55	37.71	54	-16.29	AV
V	9648.00	51.70	30.85	7.45	24.69	52.99	74	-21.01	PK
V	9648.00	35.32	30.85	7.45	24.69	36.61	54	-17.39	AV
V	12060.00	56.56	31.02	8.99	25.57	60.1	74	-13.9	PK
V	12060.00	38.20	31.02	8.99	25.57	41.74	54	-12.26	AV
H	4824.00	53.51	30.55	5.77	24.66	53.39	74	-20.61	PK
H	4824.00	36.98	30.55	5.77	24.66	36.86	54	-17.14	AV
H	7236.00	51.49	30.33	6.32	24.55	52.03	74	-21.97	PK
H	7236.00	36.04	30.33	6.32	24.55	36.58	54	-17.42	AV
H	9648.00	49.33	30.85	7.45	24.69	50.62	74	-23.38	PK
H	9648.00	34.58	30.85	7.45	24.69	35.87	54	-18.13	AV
H	12060.00	47.19	31.02	8.99	25.57	50.73	74	-23.27	PK
H	12060.00	32.61	31.02	8.99	25.57	36.15	54	-17.85	AV

Polar (H/V)	Frequency	Meter Reading	Pre-ampl ifier	Cable Loss	Antenna Factor	Emission Level	Limits	Margin	Detect or Type
	(MHz)	(dBuV)	(dB)	(dB)	(dB)	(dBuV/m)	(dBuV/ m)	(dB)	
Middle Channel:2437MHz									
V	4874.00	60.02	30.55	5.77	24.66	59.9	74	-14.1	PK
V	4874.00	42.75	30.55	5.77	24.66	42.63	54	-11.37	AV
V	7311.00	53.28	30.33	6.32	24.55	53.82	74	-20.18	PK
V	7311.00	37.01	30.33	6.32	24.55	37.55	54	-16.45	AV
V	9748.00	50.99	30.85	7.45	24.69	52.28	74	-21.72	PK
V	9748.00	35.24	30.85	7.45	24.69	36.53	54	-17.47	AV
V	12185.00	56.22	31.02	8.99	25.57	59.76	74	-14.24	PK
V	12185.00	38.57	31.02	8.99	25.57	42.11	54	-11.89	AV
H	4874.00	54.18	30.55	5.77	24.66	54.06	74	-19.94	PK
H	4874.00	37.63	30.55	5.77	24.66	37.51	54	-16.49	AV
H	7311.00	51.17	30.33	6.32	24.55	51.71	74	-22.29	PK
H	7311.00	36.14	30.33	6.32	24.55	36.68	54	-17.32	AV
H	9748.00	48.56	30.85	7.45	24.69	49.85	74	-24.15	PK
H	9748.00	34.85	30.85	7.45	24.69	36.14	54	-17.86	AV
H	12185.00	46.76	31.02	8.99	25.57	50.3	74	-23.7	PK
H	12185.00	33.10	31.02	8.99	25.57	36.64	54	-17.36	AV



Polar (H/V)	Frequency	Meter Reading	Pre-ampl ifier	Cable Loss	Antenna Factor	Emission Level	Limits	Margin	Detect or Type
	(MHz)	(dBuV)	(dB)	(dB)	(dB)	(dBuV/m)	(dBuV/ m)	(dB)	
High Channel:2462MHz									
V	4924.00	61.60	30.55	5.77	24.66	61.48	74	-12.52	PK
V	4924.00	42.95	30.55	5.77	24.66	42.83	54	-11.17	AV
V	7386.00	53.37	30.33	6.32	24.55	53.91	74	-20.09	PK
V	7386.00	37.97	30.33	6.32	24.55	38.51	54	-15.49	AV
V	9848.00	51.04	30.85	7.45	24.69	52.33	74	-21.67	PK
V	9848.00	34.92	30.85	7.45	24.69	36.21	54	-17.79	AV
V	12310.00	56.32	31.02	8.99	25.57	59.86	74	-14.14	PK
V	12310.00	38.43	31.02	8.99	25.57	41.97	54	-12.03	AV
H	4924.00	53.72	30.55	5.77	24.66	53.6	74	-20.4	PK
H	4924.00	36.98	30.55	5.77	24.66	36.86	54	-17.14	AV
H	7386.00	51.07	30.33	6.32	24.55	51.61	74	-22.39	PK
H	7386.00	36.39	30.33	6.32	24.55	36.93	54	-17.07	AV
H	9848.00	49.25	30.85	7.45	24.69	50.54	74	-23.46	PK
H	9848.00	34.74	30.85	7.45	24.69	36.03	54	-17.97	AV
H	12310.00	47.49	31.02	8.99	25.57	51.03	74	-22.97	PK
H	12310.00	32.56	31.02	8.99	25.57	36.1	54	-17.9	AV

## Remark:

1. Emission Level = Meter Reading + Antenna Factor + Cable Loss – Pre-amplifier,  
Margin= Emission Level - Limit
2. If peak below the average limit, the average emission was no test.
3. The amplitude of spurious emissions which are attenuated by more than 20dB below the permissible value has no need to be reported.



Polar (H/V)	Frequency	Meter Reading	Pre-ampl ifier	Cable Loss	Antenna Factor	Emission Level	Limits	Margin	Detect or Type
	(MHz)	(dBuV)	(dB)	(dB)	(dB)	(dBuV/m)	(dBuV/ m)	(dB)	
High Channel:2452MHz									
V	4904.00	61.71	30.55	5.77	24.66	61.59	74	-12.41	PK
V	4904.00	42.85	30.55	5.77	24.66	42.73	54	-11.27	AV
V	7356.00	53.54	30.33	6.32	24.55	54.08	74	-19.92	PK
V	7356.00	37.98	30.33	6.32	24.55	38.52	54	-15.48	AV
V	9808.00	51.39	30.85	7.45	24.69	52.68	74	-21.32	PK
V	9808.00	34.86	30.85	7.45	24.69	36.15	54	-17.85	AV
V	12260.00	56.66	31.02	8.99	25.57	60.2	74	-13.8	PK
V	12260.00	38.55	31.02	8.99	25.57	42.09	54	-11.91	AV
H	4904.00	53.79	30.55	5.77	24.66	53.67	74	-20.33	PK
H	4904.00	37.21	30.55	5.77	24.66	37.09	54	-16.91	AV
H	7356.00	51.09	30.33	6.32	24.55	51.63	74	-22.37	PK
H	7356.00	36.68	30.33	6.32	24.55	37.22	54	-16.78	AV
H	9808.00	49.20	30.85	7.45	24.69	50.49	74	-23.51	PK
H	9808.00	34.64	30.85	7.45	24.69	35.93	54	-18.07	AV
H	12260.00	47.58	31.02	8.99	25.57	51.12	74	-22.88	PK
H	12260.00	32.70	31.02	8.99	25.57	36.24	54	-17.76	AV

## Remark:

1. Emission Level = Meter Reading + Antenna Factor + Cable Loss – Pre-amplifier,  
Margin= Emission Level - Limit
2. If peak below the average limit, the average emission was no test.
3. The amplitude of spurious emissions which are attenuated by more than 20dB below the permissible value has no need to be reported.



## 5. RADIATED BAND EMISSION MEASUREMENT

### 5.1 TEST REQUIREMENT:

Test Requirement:	FCC Part15 C Section 15.209 and 15.205				
Test Method:	ANSI C63.10: 2013				
Test Frequency Range:	All of the restrict bands were tested, only the worst band's (2310MHz to 2500MHz) data was showed.				
Test site:	Measurement Distance: 3m				
Receiver setup:	Frequency	Detector	RBW	VBW	Value
	Above 1GHz	Peak	1MHz	3MHz	Peak
		Average	1MHz	3MHz	Average

### LIMITS OF RADIATED EMISSION MEASUREMENT (Above 1000MHz)

FREQUENCY (MHz)	Class B (dBuV/m) (at 3M)	
	PEAK	AVERAGE
Above 1000	74	54

#### Notes:

- (1) The limit for radiated test was performed according to FCC PART 15C.
- (2) The tighter limit applies at the band edges.
- (3) Emission level (dBuV/m)=20log Emission level (uV/m).

### 5.2 TEST PROCEDURE

Above 1GHz test procedure as below:

- a. 1. The EUT was placed on the top of a rotating table 1.5 meters above the ground at a 3 meter camber. The table was rotated 360 degrees to determine the position of the highest radiation.
- b. The EUT was set 3 meters away from the interference-receiving antenna, which was mounted on the top of a variable-height antenna tower.
- c. The antenna height is varied from one meter to four meters above the ground to determine the maximum value of the field strength. Both horizontal and vertical polarizations of the antenna are set to make the measurement.
- d. For each suspected emission, the EUT was arranged to its worst case and then the antenna was tuned to heights from 1 meter to 4 meters and the rota table was turned from 0 degrees to 360 degrees to find the maximum reading.
- e. The test-receiver system was set to Peak Detect Function and Specified Bandwidth with Maximum Hold Mode.
- f. If the emission level of the EUT in peak mode was 10dB lower than the limit specified, then testing could be stopped and the peak values of the EUT would be reported. Otherwise the emissions that did not have 10dBmargin would be re-tested one by one using peak, quasi-peak or average method as specified and then reported in a data sheet.
- g. Test the EUT in the lowest channel, the Highest channel

#### Note:

Both horizontal and vertical antenna polarities were tested and performed pretest to three orthogonal axis. The worst case emissions were reported

### 5.3 DEVIATION FROM TEST STANDARD

No deviation



## 5.4 TEST SETUP

### Radiated Emission Test-Up Frequency Above 1GHz

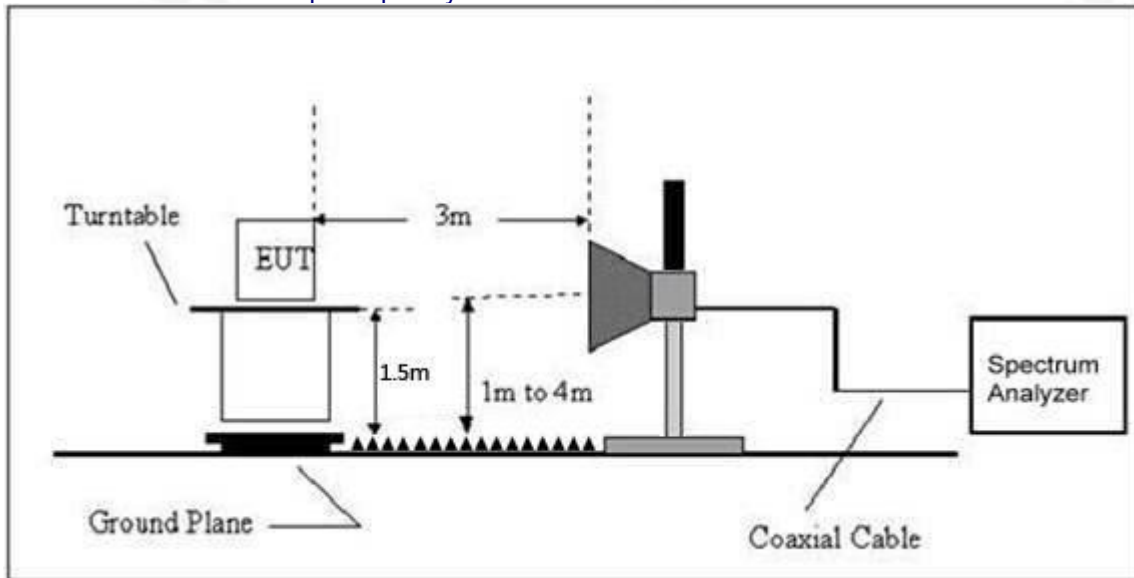

## 5.5 EUT OPERATING CONDITIONS

The EUT tested system was configured as the statements of 2.3 Unless otherwise a special operating condition is specified in the follows during the testing.



## 5.6 TEST RESULT

	Polar (H/V)	Frequency (MHz)	Meter Reading (dBuV)	Pre-amplifier (dB)	Cable Loss (dB)	Antenna Factor (dB/m)	Emission level (dBuV/m)	Limit (dBuV/m)	Margin (dB)	Detector Type	Result
802.11b	Low Channel 2412MHz										
	H	2390.00	59.50	30.22	4.85	23.98	58.11	74	-15.89	PK	PASS
	H	2390.00	47.48	30.22	4.85	23.98	46.09	54	-7.91	AV	PASS
	H	2400.00	61.01	30.22	4.85	23.98	59.62	74	-14.38	PK	PASS
	H	2400.00	48.84	30.22	4.85	23.98	47.45	54	-6.55	AV	PASS
	V	2390.00	58.70	30.22	4.85	23.98	57.31	74	-16.69	PK	PASS
	V	2390.00	47.81	30.22	4.85	23.98	46.42	54	-7.58	AV	PASS
	V	2400.00	60.37	30.22	4.85	23.98	58.98	74	-15.02	PK	PASS
	V	2400.00	49.48	30.22	4.85	23.98	48.09	54	-5.91	AV	PASS
	High Channel 2462MHz										
	H	2483.50	58.56	30.22	4.85	23.98	57.17	74	-16.83	PK	PASS
	H	2483.50	47.31	30.22	4.85	23.98	45.92	54	-8.08	AV	PASS
	H	2485.50	61.48	30.22	4.85	23.98	60.09	74	-13.91	PK	PASS
	H	2485.50	50.00	30.22	4.85	23.98	48.61	54	-5.39	AV	PASS
	V	2483.50	59.49	30.22	4.85	23.98	58.1	74	-15.9	PK	PASS
	V	2483.50	48.02	30.22	4.85	23.98	46.63	54	-7.37	AV	PASS
V	2485.50	58.80	30.22	4.85	23.98	57.41	74	-16.59	PK	PASS	
V	2485.50	47.72	30.22	4.85	23.98	46.33	54	-7.67	AV	PASS	
802.11g	Low Channel 2412MHz										
	H	2390.00	59.12	30.22	4.85	23.98	57.73	74	-16.27	PK	PASS
	H	2390.00	47.26	30.22	4.85	23.98	45.87	54	-8.13	AV	PASS
	H	2400.00	60.58	30.22	4.85	23.98	59.19	74	-14.81	PK	PASS
	H	2400.00	47.92	30.22	4.85	23.98	46.53	54	-7.47	AV	PASS
	V	2390.00	58.82	30.22	4.85	23.98	57.43	74	-16.57	PK	PASS
	V	2390.00	47.72	30.22	4.85	23.98	46.33	54	-7.67	AV	PASS
	V	2400.00	59.95	30.22	4.85	23.98	58.56	74	-15.44	PK	PASS
	V	2400.00	49.29	30.22	4.85	23.98	47.9	54	-6.1	AV	PASS
	High Channel 2462MHz										
	H	2483.50	59.20	30.22	4.85	23.98	57.81	74	-16.19	PK	PASS
	H	2483.50	47.83	30.22	4.85	23.98	46.44	54	-7.56	AV	PASS
	H	2485.50	61.72	30.22	4.85	23.98	60.33	74	-13.67	PK	PASS
	H	2485.50	50.35	30.22	4.85	23.98	48.96	54	-5.04	AV	PASS
	V	2483.50	60.17	30.22	4.85	23.98	58.78	74	-15.22	PK	PASS
	V	2483.50	47.69	30.22	4.85	23.98	46.3	54	-7.7	AV	PASS
V	2485.50	58.46	30.22	4.85	23.98	57.07	74	-16.93	PK	PASS	
V	2485.50	47.29	30.22	4.85	23.98	45.9	54	-8.1	AV	PASS	
802.11n20	Low Channel 2412MHz										
	H	2390.00	59.69	30.22	4.85	23.98	58.3	74	-15.7	PK	PASS
	H	2390.00	47.11	30.22	4.85	23.98	45.72	54	-8.28	AV	PASS
	H	2400.00	61.04	30.22	4.85	23.98	59.65	74	-14.35	PK	PASS
	H	2400.00	48.74	30.22	4.85	23.98	47.35	54	-6.65	AV	PASS
	V	2390.00	58.60	30.22	4.85	23.98	57.21	74	-16.79	PK	PASS
	V	2390.00	47.32	30.22	4.85	23.98	45.93	54	-8.07	AV	PASS
	V	2400.00	60.52	30.22	4.85	23.98	59.13	74	-14.87	PK	PASS
	V	2400.00	49.46	30.22	4.85	23.98	48.07	54	-5.93	AV	PASS



		High Channel 2462MHz									
802.11n20	H	2483.50	58.55	30.22	4.85	23.98	57.16	74	-16.84	PK	PASS
	H	2483.50	47.16	30.22	4.85	23.98	45.77	54	-8.23	AV	PASS
	H	2485.50	60.90	30.22	4.85	23.98	59.51	74	-14.49	PK	PASS
	H	2485.50	50.65	30.22	4.85	23.98	49.26	54	-4.74	AV	PASS
	V	2483.50	60.19	30.22	4.85	23.98	58.8	74	-15.2	PK	PASS
	V	2483.50	49.02	30.22	4.85	23.98	47.63	54	-6.37	AV	PASS
	V	2485.50	58.38	30.22	4.85	23.98	56.99	74	-17.01	PK	PASS
	V	2485.50	47.03	30.22	4.85	23.98	45.64	54	-8.36	AV	PASS

**Remark:**

1. Emission Level = Meter Reading + Antenna Factor + Cable Loss – Pre-amplifier, Margin= Emission Level - Limit





## 6. POWER SPECTRAL DENSITY TEST

Test Requirement:	FCC Part15 C Section 15.247 (e)
Test Method:	KDB558074 D0115.247 Meas Guidancev05r02

### 6.1 APPLIED PROCEDURES / LIMIT

FCC Part15 (15.247) , Subpart C				
Section	Test Item	Limit	Frequency Range (MHz)	Result
15.247	Power Spectral Density	8dBm/3kHz	2400-2483.5	PASS

### 6.2 TEST PROCEDURE

1. Set analyzer center frequency to DTS channel center frequency.
2. Set the span to 1.5 times the DTS bandwidth.
3. Set the RBW to:  $3 \text{ kHz} \leq \text{RBW} \leq 100 \text{ kHz}$ .
4. Set the VBW  $\geq 3 \times \text{RBW}$ .
5. Detector = peak.
6. Sweep time = auto couple.
7. Trace mode = max hold.
8. Allow trace to fully stabilize.
9. Use the peak marker function to determine the maximum amplitude level within the RBW.
10. If measured value exceeds limit, reduce RBW (no less than 3 kHz) and repeat.

### 6.3 DEVIATION FROM STANDARD

No deviation.

### 6.4 TEST SETUP



### 6.5 EUT OPERATION CONDITIONS

The EUT tested system was configured as the statements of 2.1 Unless otherwise a special operating condition is specified in the follows during the testing.



6.6 TEST RESULT

Temperature :	25.4°C	Relative Humidity :	52%
Pressure :	101kPa	Test Voltage :	DC 24V
Test Mode :	TX b Mode		

Frequency	Power Spectral Density (dBm/3kHz)	Limit (dBm/3kHz)	Result
2412 MHz	-17.63	8	PASS
2437 MHz	-17.09	8	PASS
2462 MHz	-16.87	8	PASS

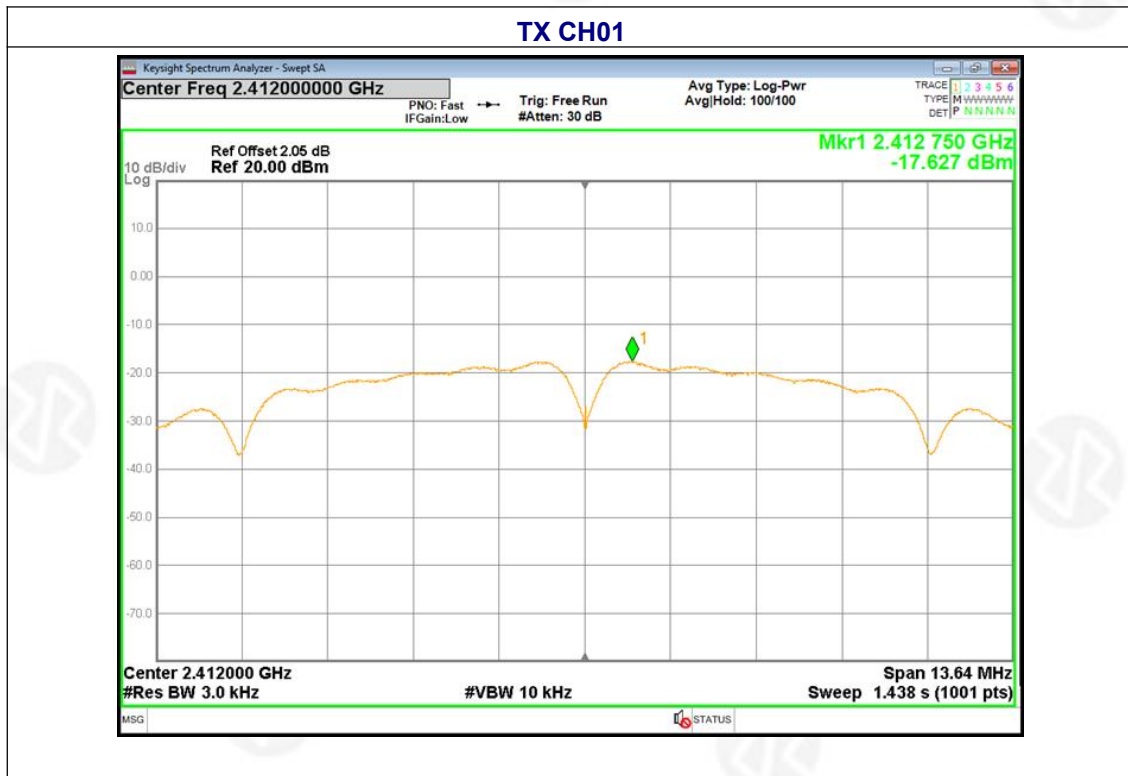



### TX CH06



### TX CH11





Temperature :	25.4°C	Relative Humidity :	52%
Pressure :	101kPa	Test Voltage :	DC 24V
Test Mode :	TX g Mode		

Frequency	Power Spectral Density (dBm/3kHz)	Limit (dBm/3kHz)	Result
2412 MHz	-16.41	8	PASS
2437 MHz	-15.9	8	PASS
2462 MHz	-15.77	8	PASS

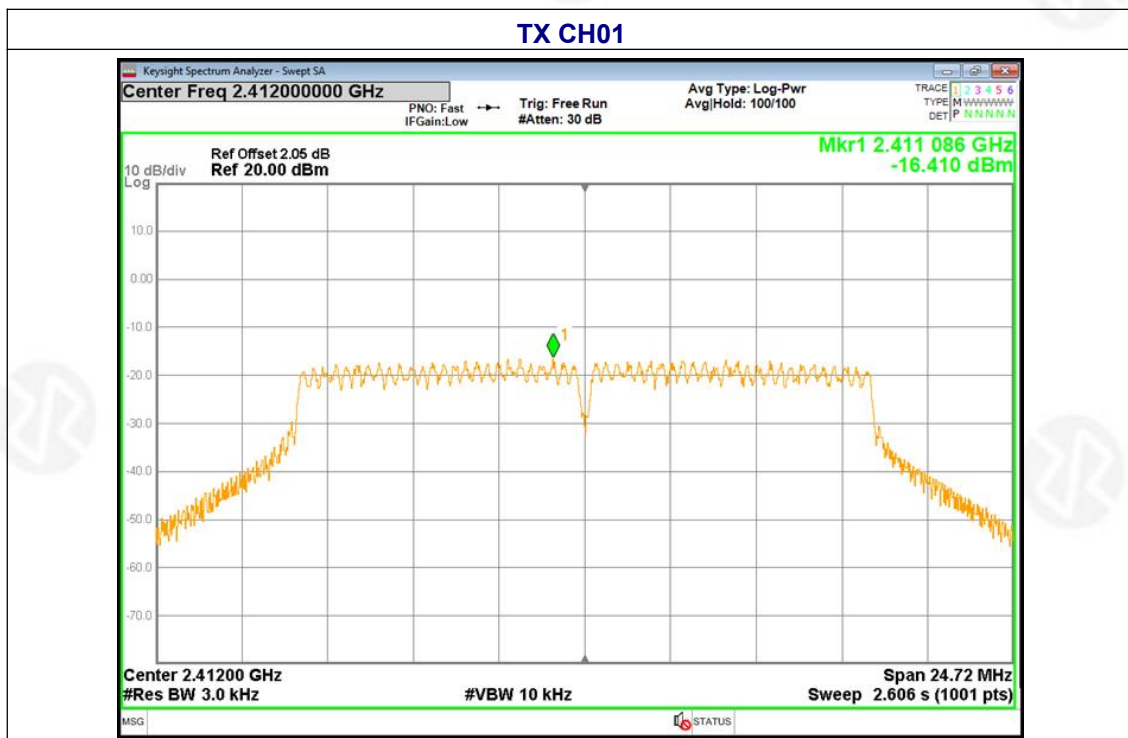



### TX CH06

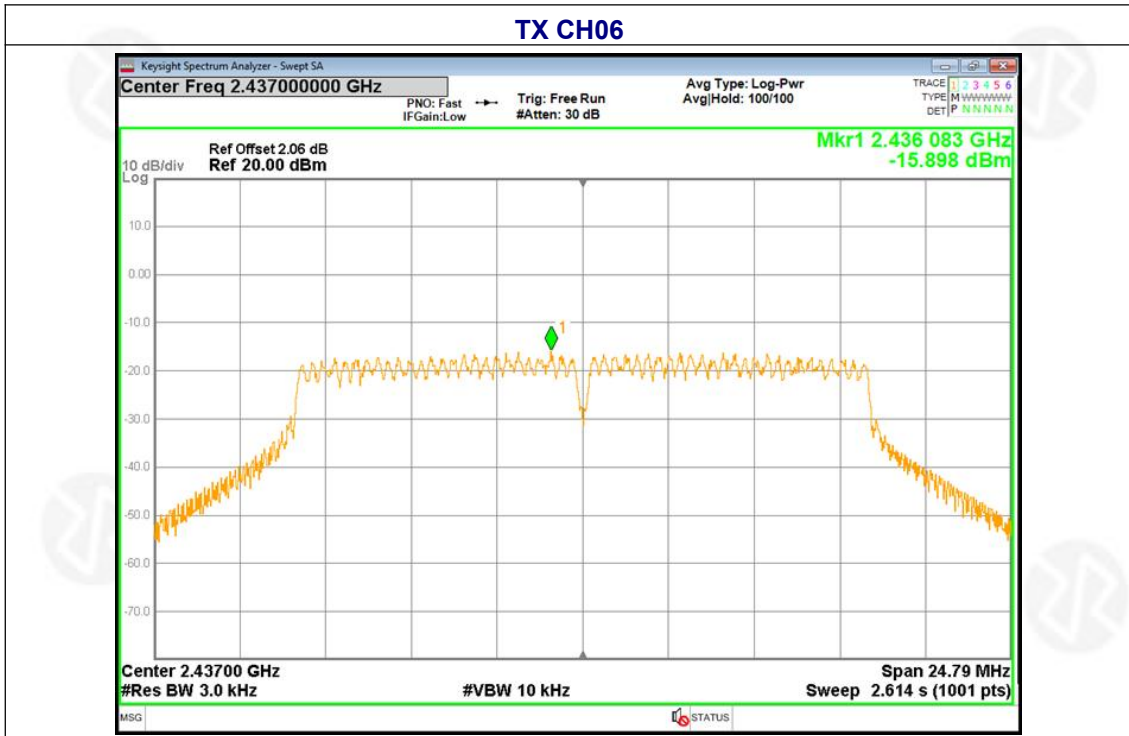

### TX CH11

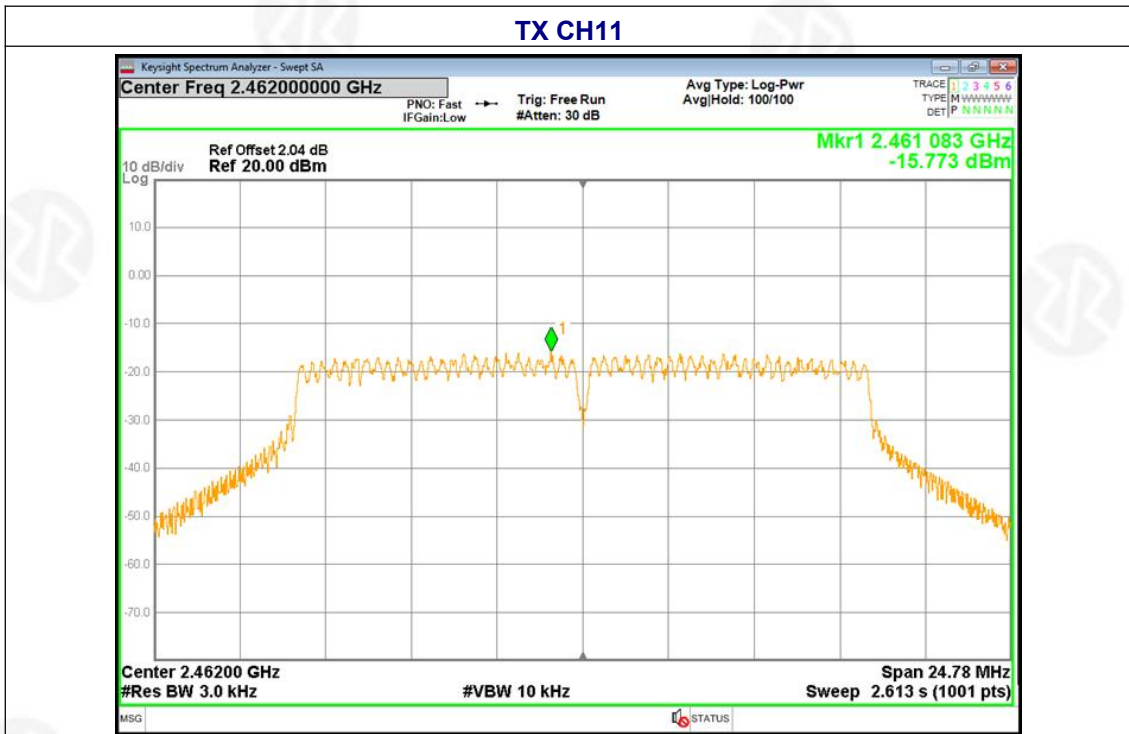



Temperature :	25.4°C	Relative Humidity :	52%
Pressure :	101kPa	Test Voltage :	DC 24V
Test Mode :	TX n Mode(20M)		

Frequency	Power Spectral Density (dBm/3kHz)	Limit (dBm/3kHz)	Result
2412 MHz	-14.5	8	PASS
2437 MHz	-14.1	8	PASS
2462 MHz	-13.94	8	PASS

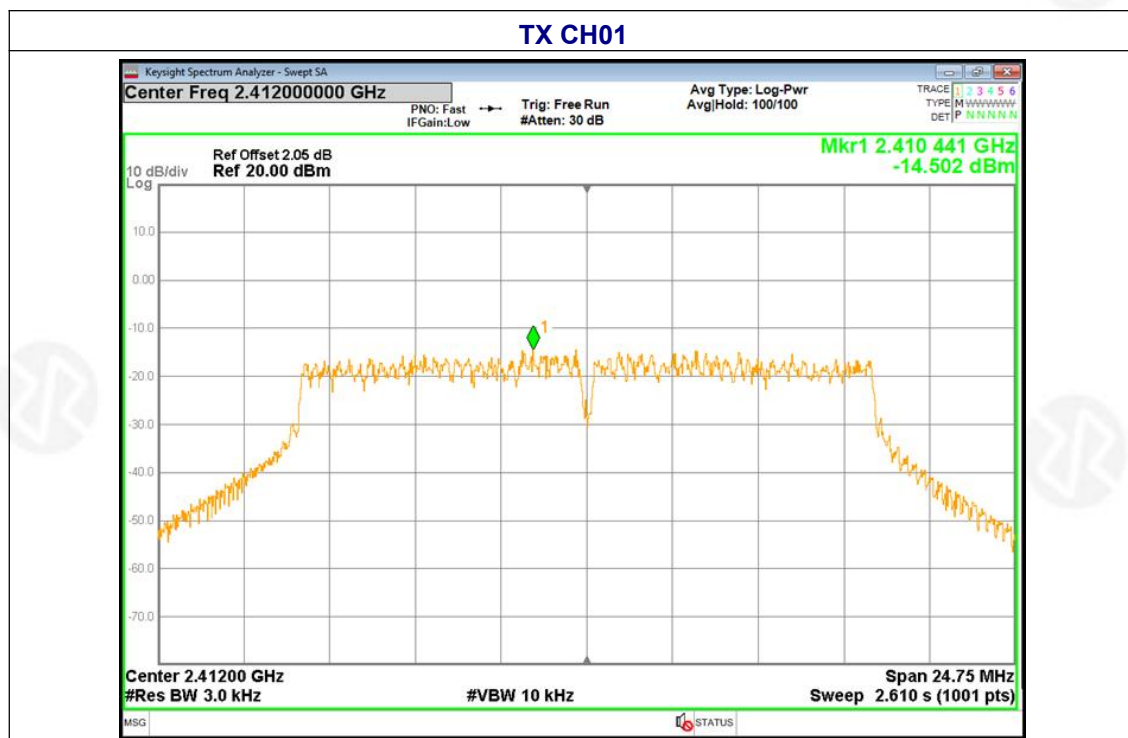



### TX CH06

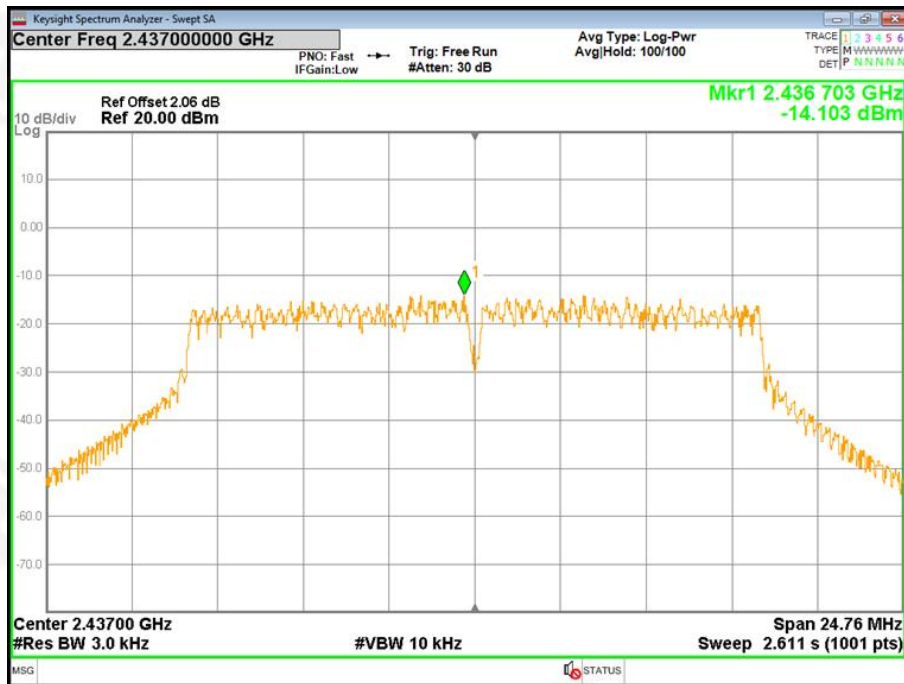

### TX CH11

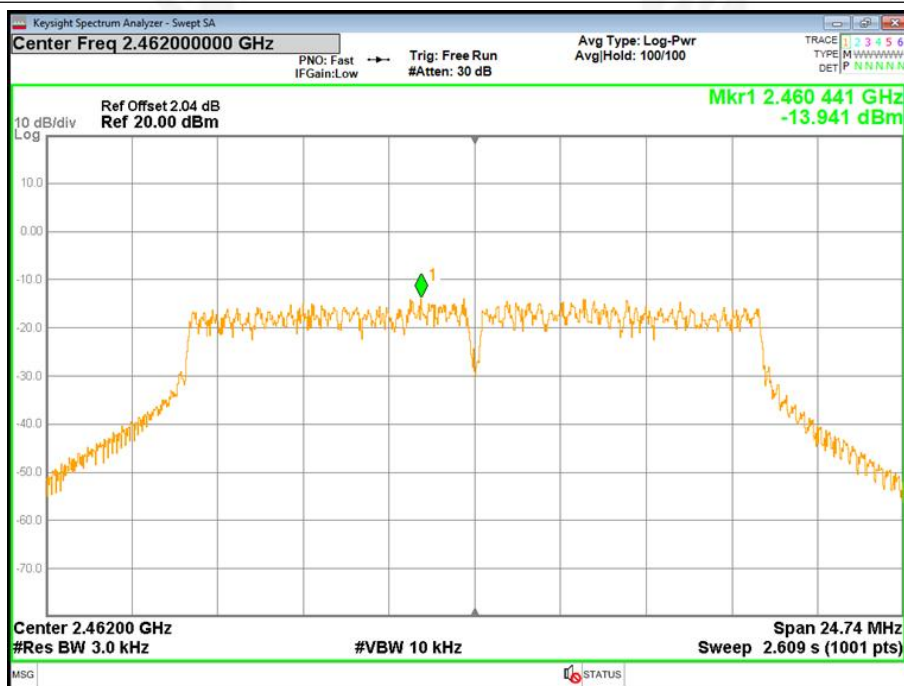



## 7. CHANNEL BANDWIDTH& 99% OCCUPY BANDWIDTH

Test Requirement:	FCC Part15 C Section 15.247 (a)(2)
Test Method:	KDB558074 D0115.247 Meas Guidancev05r02

### 7.1 APPLIED PROCEDURES / LIMIT

FCC Part15 (15.247) , Subpart C				
Section	Test Item	Limit	Frequency Range (MHz)	Result
15.247(a)(2)	Bandwidth	$\geq 500\text{KHz}$ (6dB bandwidth)	2400-2483.5	PASS

### 7.2 TEST PROCEDURE

1. Set RBW = 100 kHz.
2. Set the video bandwidth (VBW)  $\geq 3 \times \text{RBW}$ .
3. Detector = Peak.
4. Trace mode = max hold.
5. Sweep = auto couple.
6. Allow the trace to stabilize.
7. Measure the maximum width of the emission that is constrained by the frequencies associated with the two outermost amplitude points (upper and lower frequencies) that are attenuated by 6 dB relative to the maximum level measured in the fundamental emission.

### 7.3 DEVIATION FROM STANDARD

No deviation.

### 7.4 TEST SETUP



### 7.5 EUT OPERATION CONDITIONS

The EUT tested system was configured as the statements of 2.4 Unless otherwise a special operating condition is specified in the follows during the testing.





## 7.6 TEST RESULT

Temperature :	25.4℃	Relative Humidity :	52%
Pressure :	101kPa	Test Voltage :	DC 24V
Test Mode :	TX Mode		

Test CH	-6dB Occupy Bandwidth (MHz)				Result
	802.11b	802.11g	802.11n(HT20)	Limit(KHz)	
Lowest	9.093	16.477	16.502	>500	Pass
Middle	9.067	16.528	16.508		
Highest	9.075	16.518	16.496		

Test CH	99% Occupy Bandwidth (MHz)			Result
	802.11b	802.11g	802.11n(HT20)	
Lowest	14.059	16.432	16.440	Pass
Middle	14.028	16.430	16.439	
Highest	14.002	16.445	16.436	



Test plot as follows:

802.11b

802.11g

Lowest channel

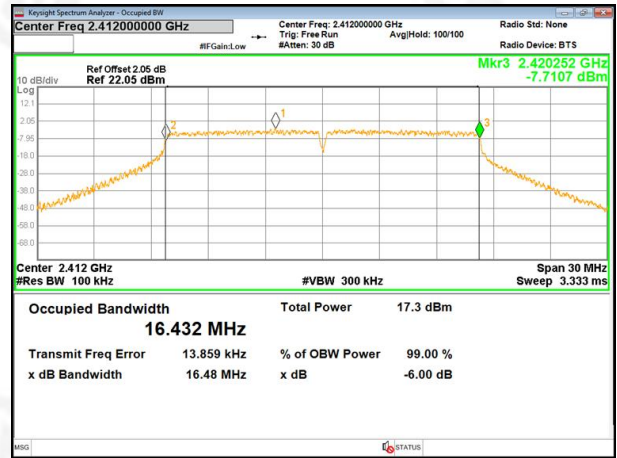
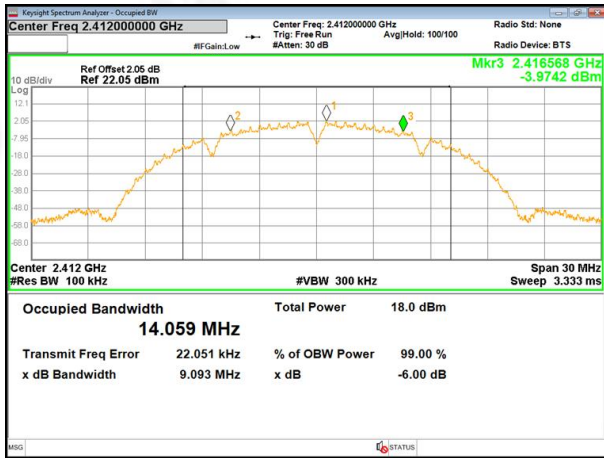

Middle channel

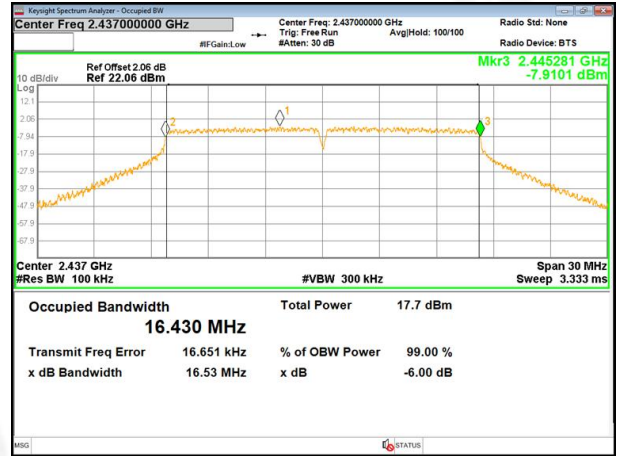
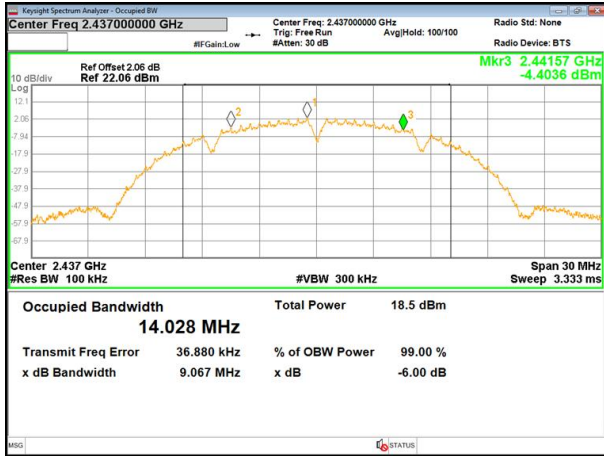

Highest channel

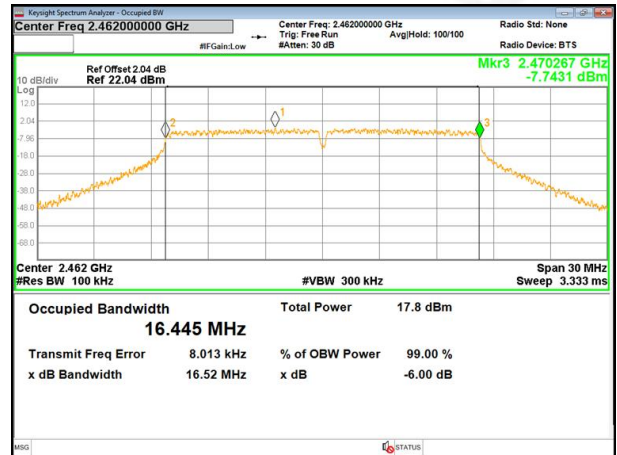
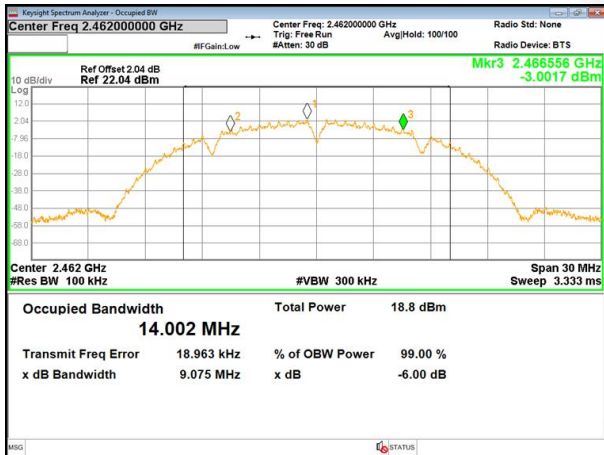



802.11n(HT20)

Lowest channel

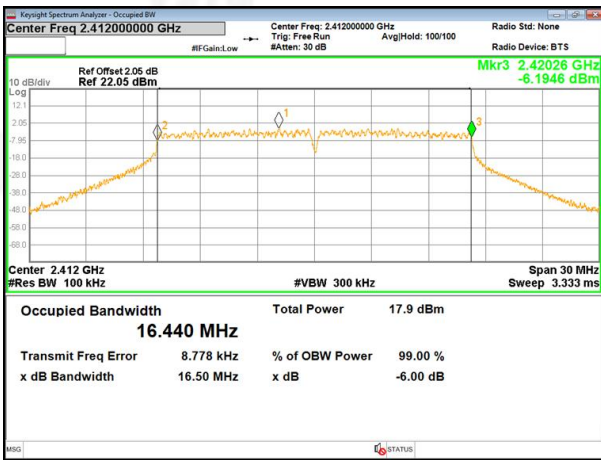

Middle channel

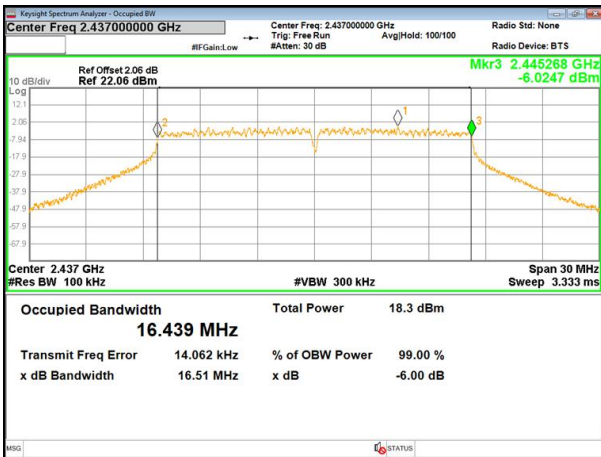

Highest channel

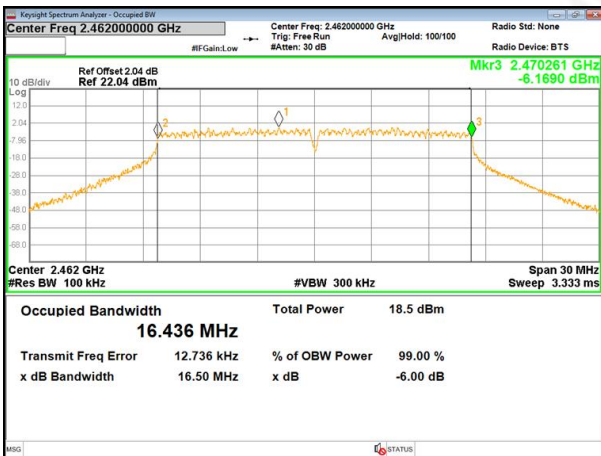



### 8. PEAK OUTPUT POWER TEST

Test Requirement:	FCC Part15 C Section 15.247 (b)(3)
Test Method:	KDB558074 D0115.247 Meas Guidancev05r02

#### 8.1 APPLIED PROCEDURES/LIMIT

FCC Part15 (15.247) , Subpart C				
Section	Test Item	Limit	Frequency Range (MHz)	Result
15.247(b)(3)	Peak Output Power	1 watt or 30dBm	2400-2483.5	PASS

#### 8.2 TEST PROCEDURE

- a. The EUT was directly connected to the Power meter

#### 8.3 DEVIATION FROM STANDARD

No deviation.

#### 8.4 TEST SETUP



#### 8.5 EUT OPERATION CONDITIONS

The EUT tested system was configured as the statements of 2.4 Unless otherwise a special operating condition is specified in the follows during the testing.



### 8.6 TEST RESULT

Temperature :	25.2°C	Relative Humidity :	55%
Pressure :	101kPa	Test Voltage :	DC 24V

Test CH	Peak Output Power (dBm)			Limit(dBm)	Result
	802.11b	802.11g	802.11n(HT20)		
Lowest	13.35	16.37	16.82	30.00	Pass
Middle	13.82	16.69	17.16		
Highest	14.10	16.77	17.34		



## 9. CONDUCTED BAND EDGE AND SPURIOUS EMISSION

Test Requirement:	FCC Part15 C Section 15.247 (d)
Test Method:	KDB558074 D0115.247 Meas Guidancev05r02

### 9.1 APPLICABLE STANDARD

in any 100 kHz bandwidth outside the frequency bands in which the spread spectrum intentional radiator is operating, the radio frequency power that is produced by the intentional radiator shall be at least 20dB below that in the 100kHz bandwidth within the band that contains the highest level of the desired power, In addition, radiated emissions which fall in the restricted bands, as defined in§15.205(a), must also comply with the radiated emission limits specified in15.209(a).

### 9.2 TEST PROCEDURE

Using the following spectrum analyzer setting:

- A) Set the RBW = 100KHz.
- B) Set the VBW = 300KHz.
- C) Sweep time = auto couple.
- D) Detector function = peak.
- E) Trace mode = max hold.
- F) Allow trace to fully stabilize.

### 9.3 DEVIATION FROM STANDARD

No deviation.

### 9.4 TEST SETUP

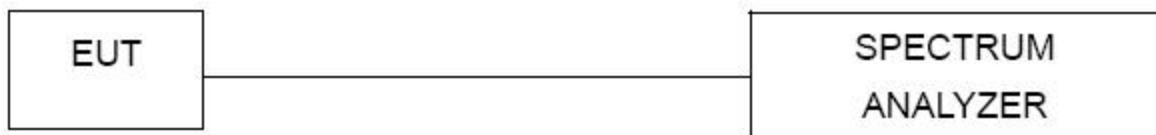

### 9.5 EUT OPERATION CONDITIONS

The EUT tested system was configured as the statements of 2.4 Unless otherwise a special operating condition is specified in the follows during the testing.

### 9.6 TEST RESULTS



Test plot as follows:

Test mode: 802.11b

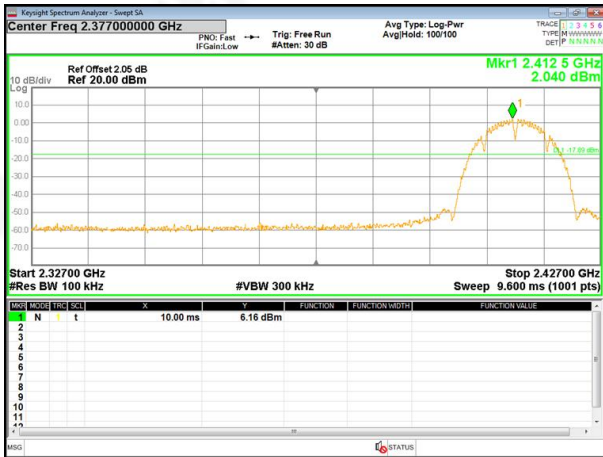

Lowest channel



Highest channel

Test mode: 802.11g

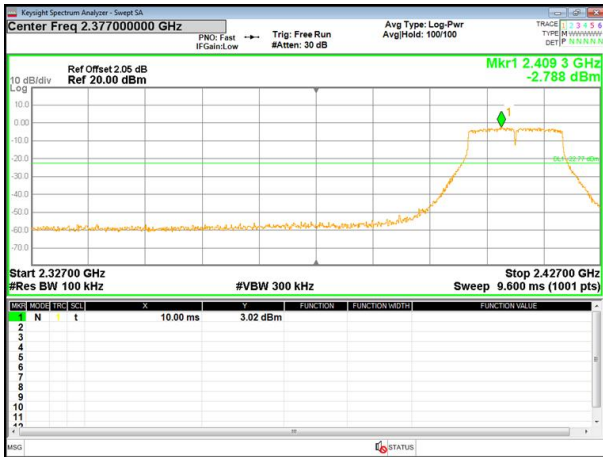

Lowest channel



Highest channel

Test mode: 802.11n(HT20)

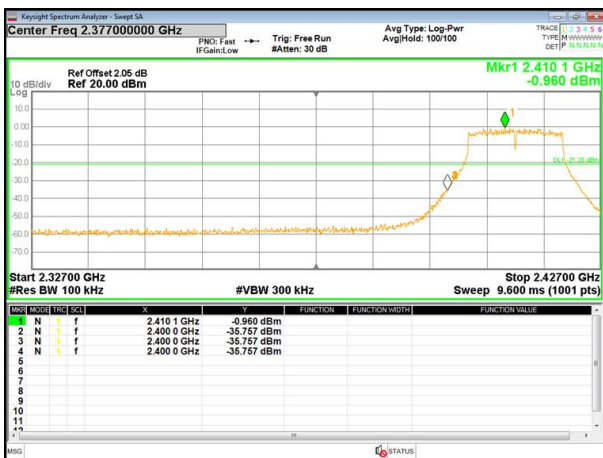

Lowest channel



Highest channel



Test plot as follows:

802.11b	802.11g
---------	---------

Lowest channel

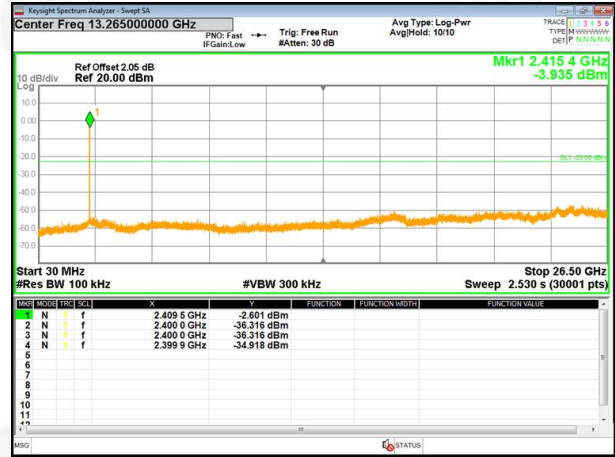
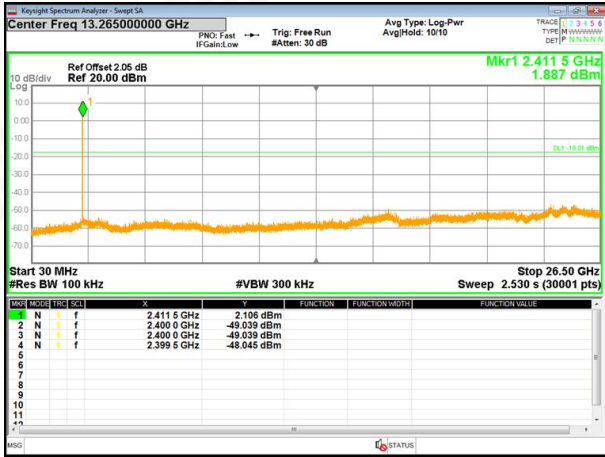

Middle channel

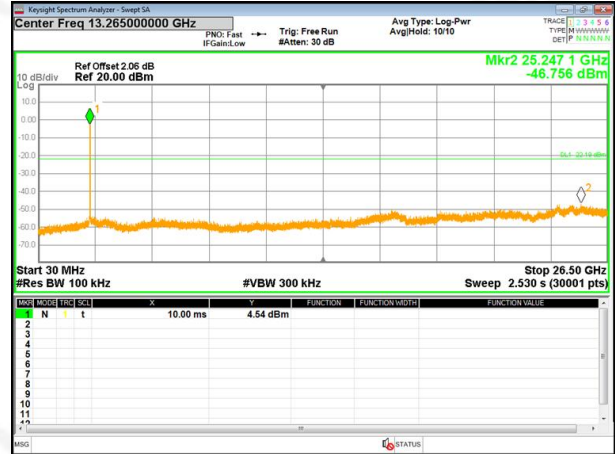
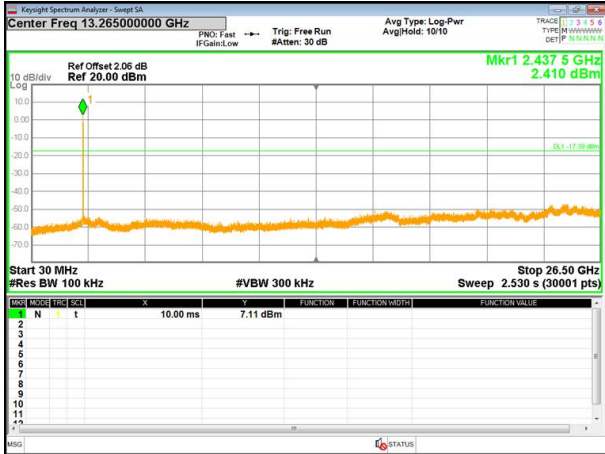

Highest channel







802.11n(HT20)

Lowest channel

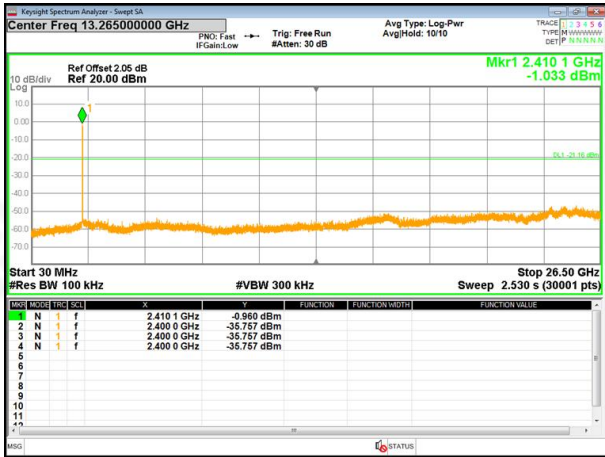

Middle channel

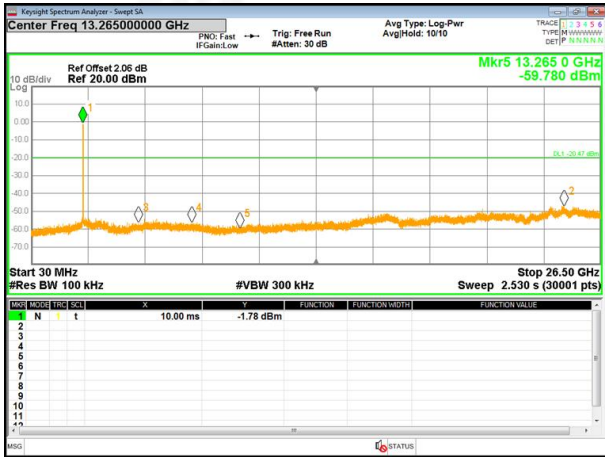

Highest channel

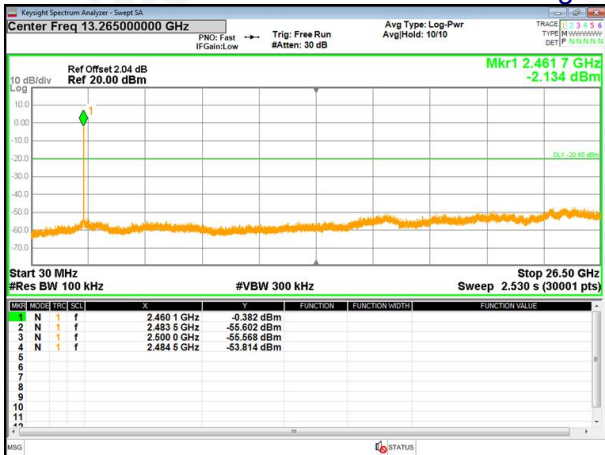



## 10. ANTENNA REQUIREMENT

Standard requirement:	FCC Part15 C Section 15.203 /247(b)(4)
15.203 requirement: An intentional radiator shall be designed to ensure that no antenna other than that furnished by the responsible party shall be used with the device. The use of a permanently attached antenna or of an antenna that uses a unique coupling to the intentional radiator, the manufacturer may design the unit so that a broken antenna can be replaced by the user, but the use of a standard antenna jack or electrical connector is prohibited.	
15.247(b) (4) requirement: (4) The conducted output power limit specified in paragraph (b) of this section is based on the use of antennas with directional gains that do not exceed 6 dBi. Except as shown in paragraph (c) of this section, if transmitting antennas of directional gain greater than 6 dBi are used, the conducted output power from the intentional radiator shall be reduced below the stated values in paragraphs (b)(1), (b)(2), and (b)(3) of this section, as appropriate, by the amount in dB that the directional gain of the antenna exceeds 6 dBi.	
EUT Antenna:	
The antenna is PCB Antenna, the best case gain of the antenna is 2.54dBi, reference to the appendix II for details	



## 11. TEST SETUP PHOTO

Reference to the appendix I for details.

## 12. EUT CONSTRUCTIONAL DETAILS

Reference to the appendix II for details.

\*\*\*\*\* END OF REPORT \*\*\*\*\*