

TEST REPORT

Product Name : Guide Camera
Model Number : SV905C
FCC ID : 2A3NOSV905C

Prepared for : ZHENGZHOU YSAIR TECHNOLOGY CO.,LTD
Address : ROOM 709,SANJIANG BUILDING,NO.170 NANYANG
ROAD,HUIJI DISTRICT, ZHENGZHOU, HENAN, CHINA

Prepared by : EMTEK (SHENZHEN) CO., LTD.
Address : Building 69, Majialong Industry Zone,
Nanshan District, Shenzhen, Guangdong, China

Tel: (0755) 26954280
Fax: (0755) 26954282

Report Number : ENS2202140037W00301R
Date(s) of Tests : February 14, 2022 to March 24, 2022
Date of issue : March 24, 2022

TABLE OF CONTENT

Test Report Description	Page
1. SUMMARY OF TEST RESULTS.....	5
2. GENERAL INFORMATION.....	6
2.1. Description of Device (EUT).....	6
2.2. Input / Output Ports.....	7
2.3. Independent Operation Modes.....	8
2.4. Test Manner.....	8
2.5. Test Software.....	8
2.6. Description of Test Facility.....	9
2.7. Measurement Uncertainty.....	9
3. MEASURING DEVICE AND TEST EQUIPMENT.....	10
3.1. For Power Line Conducted Emission Measurement.....	10
3.2. For Radiated Emission Measurement.....	10
4. POWER LINE CONDUCTED EMISSION MEASUREMENT.....	11
4.1. Block Diagram of Test Setup.....	11
4.2. Limits.....	11
4.3. Test Procedure.....	11
4.4. Measuring Results.....	12
5. RADIATED EMISSION MEASUREMENT (UP TO 1GHz).....	15
5.1. Block Diagram of Test Setup.....	15
5.2. Radiated Limit.....	15
5.3. Test Procedure.....	15
5.4. Measuring Results.....	16
6. RADIATED EMISSION MEASUREMENT (ABOVE 1GHz).....	19
6.1. Block Diagram of Test Setup.....	19
6.2. Radiated Limit.....	19
6.3. Test Procedure.....	19
6.4. Measuring Results.....	20
7. PHOTOGRAPHS.....	23
7.1. Photos of Conducted Emission Measurement.....	23
7.2. Photos of Radiation Emission Measurement.....	24
APPENDIX A: Warning Labels	
APPENDIX B: Warning Statement	
APPENDIX C: Photos of EUT	

TEST REPORT DESCRIPTION

Applicant : ZHENGZHOU YSAIR TECHNOLOGY CO.,LTD
Address : ROOM 709,SANJIANG BUILDING,NO.170 NANYANG ROAD,HUIJI DISTRICT,
ZHENGZHOU, HENAN, CHINA
Manufacturer : ZHENGZHOU YSAIR TECHNOLOGY CO.,LTD
Address : ROOM 709,SANJIANG BUILDING,NO.170 NANYANG ROAD,HUIJI DISTRICT,
ZHENGZHOU, HENAN, CHINA
Trade Mark : SVBONY
EUT : Guide Camera
Model Number : SV905C

Measurement Procedure Used:

FCC CFR Title 47, Part 15, Subpart B, Class B
ANSI C63.4-2014

The device described above is tested by EMTEK (SHENZHEN) CO., LTD. to determine the maximum emission levels emanating from the device and the severe levels of the device can endure and its performance criterion. The measurement results are contained in this test report and EMTEK (SHENZHEN) CO., LTD. is assumed full of responsibility for the accuracy and completeness of these measurements. Also, this report shows that the EUT (Equipment under Test) is technically compliant with the FCC requirements.

This report applies to above tested sample only and shall not be reproduced in part without written approval of EMTEK (SHENZHEN) CO., LTD.

Date of Test : February 14, 2022 to March 24, 2022

Prepared by : 
Luo peiye/Editor

Reviewer : 
Joe Xia/Supervisor

Approve & Authorized Signer : 
Lisa Wang/Manager



Modified Information

Version	Report No.	Revision Data	Summary
Ver.1.0	ENS2202140037W00301R	/	Original Version



1. SUMMARY OF TEST RESULTS

EMISSION		
Description of Test Item	Standard & Limits	Results
Conducted Disturbance at Mains Terminals	FCC Part 15, Subpart B- Section 15.107, Class B ANSI C63.4-2014	Pass
Radiated Disturbance	FCC Part 15, Subpart B- Section 15.109, Class B ANSI C63.4-2014	Pass
Note: N/A is an abbreviation for Not Applicable.		



2. GENERAL INFORMATION

2.1. Description of Device (EUT)

EUT	:	Guide Camera
Model Number	:	SV905C
Power supply	:	USB 5V (5V from PC)
Test Voltage	:	AC 120V/60Hz(DC 5V from PC)
Sample Number	:	1#
Applicant	:	ZHENGZHOU YSAIR TECHNOLOGY CO.,LTD
Address	:	ROOM 709,SANJIANG BUILDING,NO.170 NANYANG ROAD,HUIJI DISTRICT, ZHENGZHOU, HENAN, CHINA
Manufacturer	:	ZHENGZHOU YSAIR TECHNOLOGY CO.,LTD
Address	:	ROOM 709,SANJIANG BUILDING,NO.170 NANYANG ROAD,HUIJI DISTRICT, ZHENGZHOU, HENAN, CHINA
Factory	:	Hong Kong Svbonny Technology Co.,Ltd
Address	:	Unit B, 5th Floor, Gallo Commercial Building, 114-118 Lockhart Road, Wanchai, Hong Kong
Date of Received	:	February 14, 2022
Date of Test	:	February 14, 2022 to March 24, 2022

2.2. Input / Output Ports

EUT Cable List and Details			
Cable Description	Length (m)	Shielded/Unshielded	With / Without Ferrite
/	/	/	/

Auxiliary Cable List and Details			
Cable Description	Length (m)	Shielded/Unshielded	With / Without Ferrite
/	/	/	/

Auxiliary Equipment List and Details			
Description	Manufacturer	Model	Serial Number
Notebook	LENOVO	M713A	SA12582190

Notes:

- 1) All the equipment/cables were placed in the worst-case configuration to maximize the emission during the test.
- 2) Grounding was established in accordance with the manufacturer's requirements and conditions for the intended use.

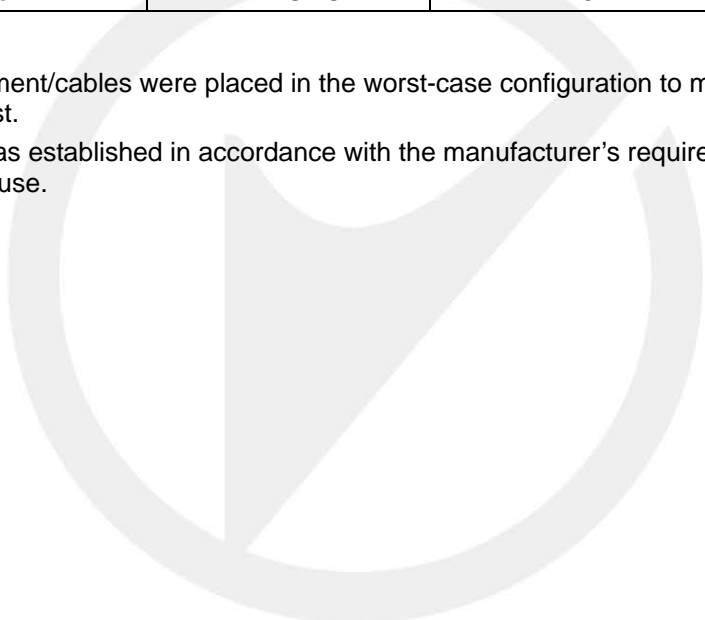

2.3. Independent Operation Modes

A. On

1. Working mode

2.4. Test Manner

Test Items	Test Voltage	Operation Modes	Worst case
Conducted Emission	DC 5V from PC (AC 120V/60Hz)	Mode A	Mode A.1 (AC 120V/60Hz)
Radiated Emission	DC 5V from PC (AC 120V/60Hz)	Mode A	Mode A.1 (AC 120V/60Hz)

2.5. Test Software

Item	Software
Conducted Emission	: EMTEK(Ver.CON-03A1)-Shenzhen
Radiated Emission	: EMTEK(Ver.RA-03A1)-Shenzhen

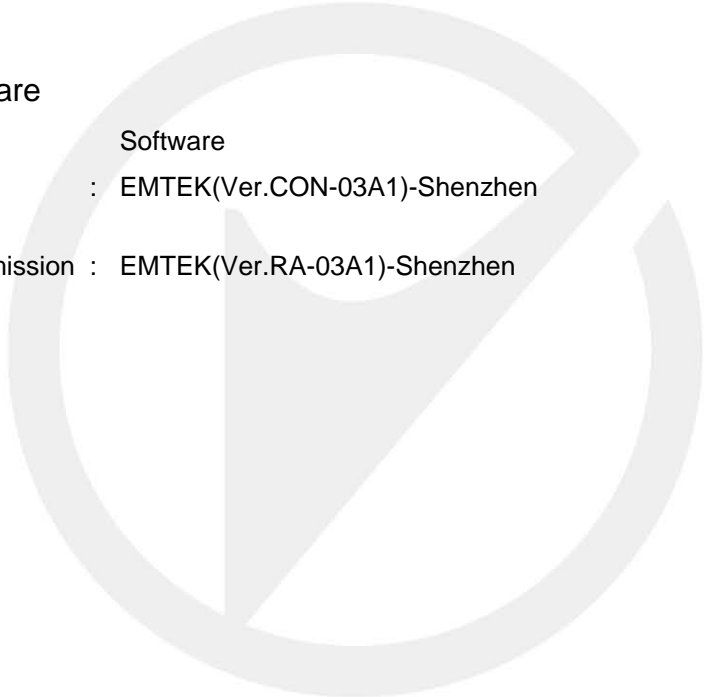

2.6. Description of Test Facility

Site Description	
EMC Lab.	<p>Accredited by CNAS The Certificate Registration Number is L2291. The Laboratory has been assessed and proved to be in compliance with CNAS-CL01 (identical to ISO/IEC 17025:2017)</p> <p>Accredited by FCC Designation Number: CN1204 Test Firm Registration Number: 882943</p> <p>Accredited by A2LA The Certificate Number is 4321.01.</p> <p>Accredited by Industry Canada The Conformity Assessment Body Identifier is CN0008</p>
Name of Firm	: EMTEK (SHENZHEN) CO., LTD.
Site Location	: Building 69, Majialong Industry Zone, Nanshan District, Shenzhen, Guangdong, China

2.7. Measurement Uncertainty

Test Item	Uncertainty
Conducted Emission Uncertainty	: 3.16dB(9k~150kHz Conduction 2#) 2.90dB(150k-30MHz Conduction 2#)
Radiated Emission Uncertainty (3m Chamber)	: 3.78dB (30M~1GHz Polarize: H) 4.27dB (30M~1GHz Polarize: V) 4.46dB (1~6GHz)
Uncertainty for test site temperature and humidity	: 0.6°C 4%

3. MEASURING DEVICE AND TEST EQUIPMENT

3.1. For Power Line Conducted Emission Measurement

Equipment	Manufacturer	Model No.	Serial No.	Last Cal.	Cal. Interval
EMI Test Receiver	Rohde & Schwarz	ESCI	101384	2021/5/15	1Year
AMN	Rohde & Schwarz	ENV216	5	2021/5/15	1Year
AMN	Kyoritsu	KNW-407	8-1492-9	2021/5/16	1Year
EMI Test Receiver	Rohde & Schwarz	ESCI	101045	2021/5/15	1Year
PULSE LIMITER	Rohde & Schwarz	ESH3-Z2	100107	2021/5/15	1Year
AMN	Rohde & Schwarz	ESH3-Z5	100191	2021/5/15	1Year

3.2. For Radiated Emission Measurement

Equipment	Manufacturer	Model No.	Serial No.	Last Cal.	Cal. Interval
Pre-Amplifier	HP	8447F	2944A07999	2021/5/15	1Year
Pre-Amplifier	HP	8447F	2944A07999	2021/5/15	1Year
EMI Test Receiver	Rohde & Schwarz	ESCI	101414	2021/5/15	1Year
Bilog Antenna	Schwarzbeck	VULB9163	712	2021/7/5	2 Year
Horn antenna	Schwarzbeck	BBHA9120D	9120D-1178	2020/7/4	2 Year
Pre-Amplifier	Lunar EM	LNA1G18-48	J101113101000 1	2021/5/15	1Year
Spectrum Analyzer	Rohde & Schwarz	FSV40	100967	2021/5/15	1Year
Horn antenna	Schwarzbeck	BBHA9170	9170-399	2021/6/12	2 Year

4. POWER LINE CONDUCTED EMISSION MEASUREMENT

4.1. Block Diagram of Test Setup

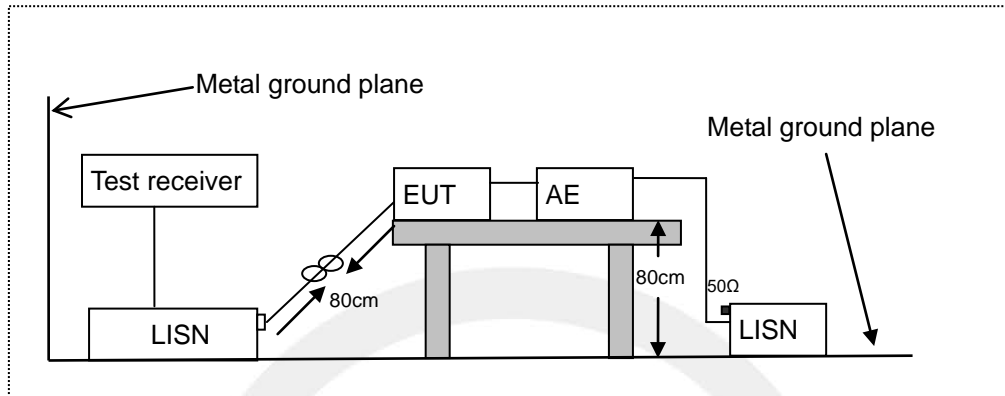

LISN: Line Impedance Stabilization Network
 AE: Associated equipment
 EUT: Equipment under test

4.2. Limits

FCC Part 15, Subpart B, Class B

Frequency (MHz)	Limit (dB μ V)	
	Quasi-peak Level	Average Level
0.15 ~ 0.50	66.0 ~ 56.0 *	56.0 ~ 46.0 *
0.50 ~ 5.00	56.0	46.0
5.00 ~ 30.00	60.0	50.0

NOTE1-The lower limit shall apply at the transition frequencies.
 NOTE2-The limit decreases linearly with the logarithm of the frequency in the range 0.15MHz to 0.50MHz.

4.3. Test Procedure

The EUT was placed on a desk 0.8 m height from the metal ground plane and 0.4 m from the conducting wall of the shielding room and it was kept at least 0.8 m from any other grounded conducting surface. The size of the table will nominally be 1.5 m x1.0 m.

The rear of the arrangement shall be flush with the back of the supporting tabletop unless that would not be possible or typical of normal use.

All units of equipment forming the system under test (includes the EUT as well as connected peripherals and associated equipment or devices) shall be arranged such that a nominal 0.1 m separation is achieved between the neighboring units.

Connect EUT to the power mains through a line impedance stabilization network (LISN). Where the mains cable supplied by the manufacturer is longer than 1 m, the excess should be folded at the

centre into a bundle no longer than 0.4 m, so that its length is shortened to 1 m.

All the support units are connecting to the other LISN.

The LISN provides 50 ohm coupling impedance for the measuring instrument.

Both sides of AC line were checked for maximum conducted interference.

The frequency range from 150 kHz to 30 MHz was sweep.

Set the test-receiver system to quasi peak detect function and average detect function, and to measure the conducted emissions values.

Test results were obtained from the following equation:

Emission Level (dBμV) = LISN Factor (dB) + Cable Loss (dB) + Reading (dBμV)

Margin (dB) = Emission Level (dBμV) - Limit (dBμV)

4.4. Measuring Results

Pass

Temperature	:	22.4°C
Humidity	:	57%
Atmospheric Pressure	:	101kpa
Test Engineer	:	YJ
Test Date	:	2022-2-17

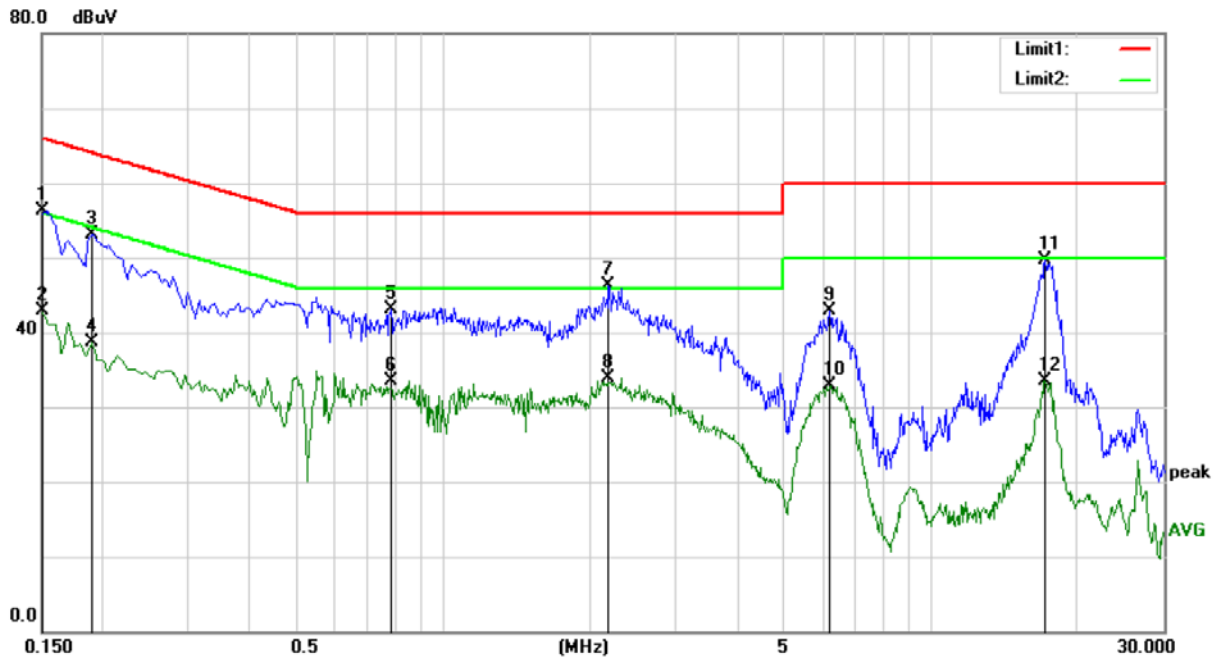

Site Conduction #1

Phase: **L1**

Temperature: 22.4

Limit: (CE)FCC PART 15 class B_QP

Power: DC 5V from PC

Humidity: 57 %

Mode: Working Mode

Note:

No.	Mk.	Freq.	Reading Level	Correct Factor	Measurement	Limit	Over	Detector	Comment
		MHz	dBuV	dB	dBuV	dBuV	dB		
1		0.1500	46.87	9.44	56.31	66.00	-9.69	QP	
2		0.1500	33.48	9.44	42.92	56.00	-13.08	AVG	
3		0.1900	43.62	9.44	53.06	64.04	-10.98	QP	
4		0.1900	29.24	9.44	38.68	54.04	-15.36	AVG	
5		0.7800	33.69	9.41	43.10	56.00	-12.90	QP	
6		0.7800	24.07	9.41	33.48	46.00	-12.52	AVG	
7	*	2.1850	36.55	9.81	46.36	56.00	-9.64	QP	
8		2.1850	24.11	9.81	33.92	46.00	-12.08	AVG	
9		6.2050	33.08	9.89	42.97	60.00	-17.03	QP	
10		6.2050	23.09	9.89	32.98	50.00	-17.02	AVG	
11		17.1550	39.54	10.13	49.67	60.00	-10.33	QP	
12		17.1550	23.37	10.13	33.50	50.00	-16.50	AVG	

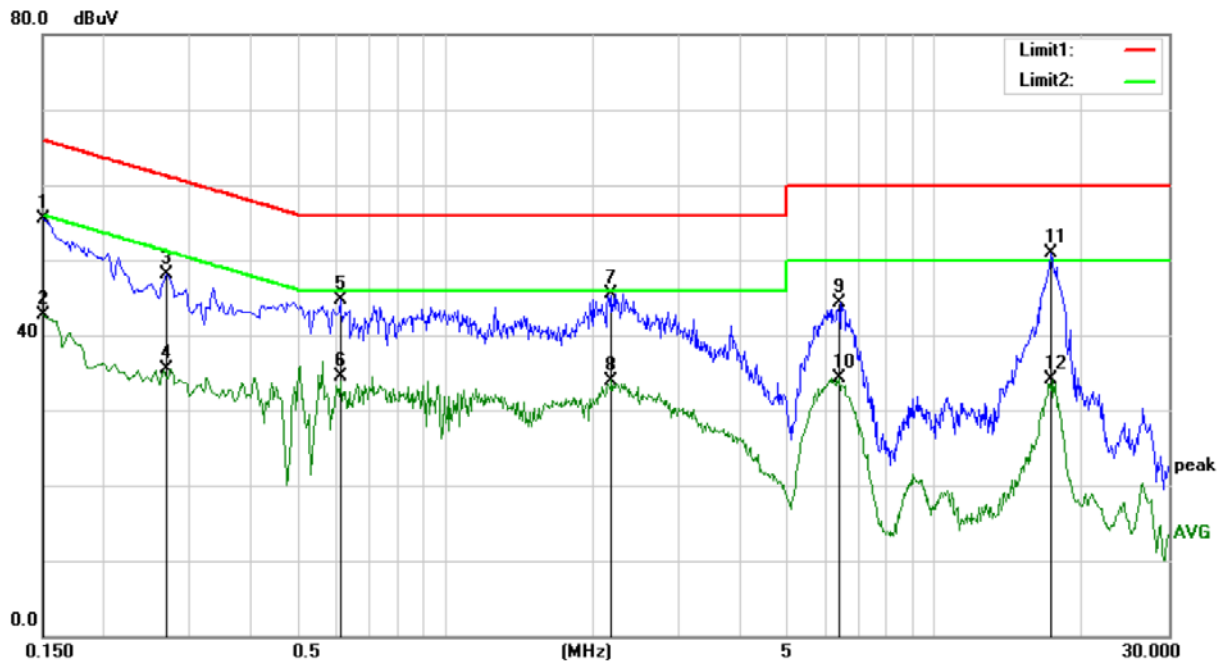

Site Conduction #1

Phase: **N**

Temperature: 22.4

Limit: (CE)FCC PART 15 class B_QP

Power: DC 5V from PC

Humidity: 57 %

Mode: Working Mode

Note:

No.	Mk.	Freq. MHz	Reading Level dBuV	Correct Factor dB	Measure- ment dBuV	Limit dBuV	Over dB	Detector	Comment
1		0.1500	46.09	9.44	55.53	66.00	-10.47	QP	
2		0.1500	33.32	9.44	42.76	56.00	-13.24	AVG	
3		0.2700	38.75	9.33	48.08	61.12	-13.04	QP	
4		0.2700	26.13	9.33	35.46	51.12	-15.66	AVG	
5		0.6100	35.51	9.28	44.79	56.00	-11.21	QP	
6		0.6100	25.16	9.28	34.44	46.00	-11.56	AVG	
7		2.1850	35.62	9.81	45.43	56.00	-10.57	QP	
8		2.1850	24.19	9.81	34.00	46.00	-12.00	AVG	
9		6.3550	34.40	9.90	44.30	60.00	-15.70	QP	
10		6.3550	24.47	9.90	34.37	50.00	-15.63	AVG	
11	*	17.2550	40.72	10.14	50.86	60.00	-9.14	QP	
12		17.2550	24.00	10.14	34.14	50.00	-15.86	AVG	

5. RADIATED EMISSION MEASUREMENT (UP TO 1GHz)

5.1. Block Diagram of Test Setup

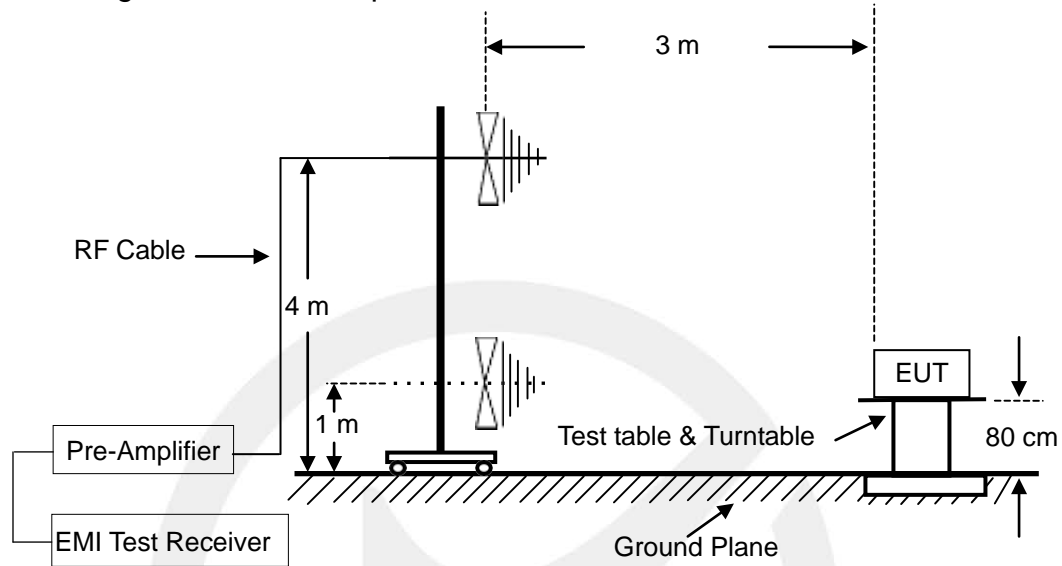

5.2. Radiated Limit

FCC Part 15, Subpart B, Class B

Frequency MHz	Distance Meters	Field Strengths Limit	
		$\mu\text{V}/\text{m}$	$\text{dB}(\mu\text{V})/\text{m}$
30 ~ 88	3	100	40.0
88 ~ 216	3	150	43.5
216 ~ 960	3	200	46.0
960 ~ 1000	3	500	54.0

5.3. Test Procedure

The EUT was placed on a non-conductive table whose total height equaled 80cm. All units of equipment forming the system under test (includes the EUT as well as connected peripherals and associated equipment or devices) shall be arranged such that a nominal 0.1 m separation is achieved between the neighboring units. Where the mains cable supplied by the manufacturer is longer than 1 m, the excess should be folded at the center into a bundle no longer than 0.4 m, so that its length is shortened to 1 m.

The EUT was set 3 meters away from the receiving antenna that was mounted on a non-conductive mast. The antenna can move up and down between 1 to 4 meters to find out the maximum emission level.

The turntable can rotate 360 degree to determine the position of the maximum emission level.

The initial testing identified the frequency that has the highest disturbance relative to the limit while operating the EUT in typical modes of operation and cable positions in a test setup representative of

typical system configuration.

The identification of the frequency of highest emission with respect to the limit was found by investigating emissions at a number of significant frequencies. The probable frequency of maximum emission had been found and that the associated cable and EUT configuration and mode of operation had been identified.

The bandwidth of the Receiver is set at 120 kHz.

Test results were obtained from the following equation:

Emission level (dB μ V/m) = Antenna Factor - Amp Factor + Cable Loss + Reading

Margin (dB) = Emission Level (dB μ V/m) - Limit (dB μ V/m)

5.4. Measuring Results

PASS.

Temperature	:	22°C
Humidity	:	43%
Atmospheric Pressure	:	101kpa
Test Engineer	:	LEEY
Test Date	:	2022-2-17

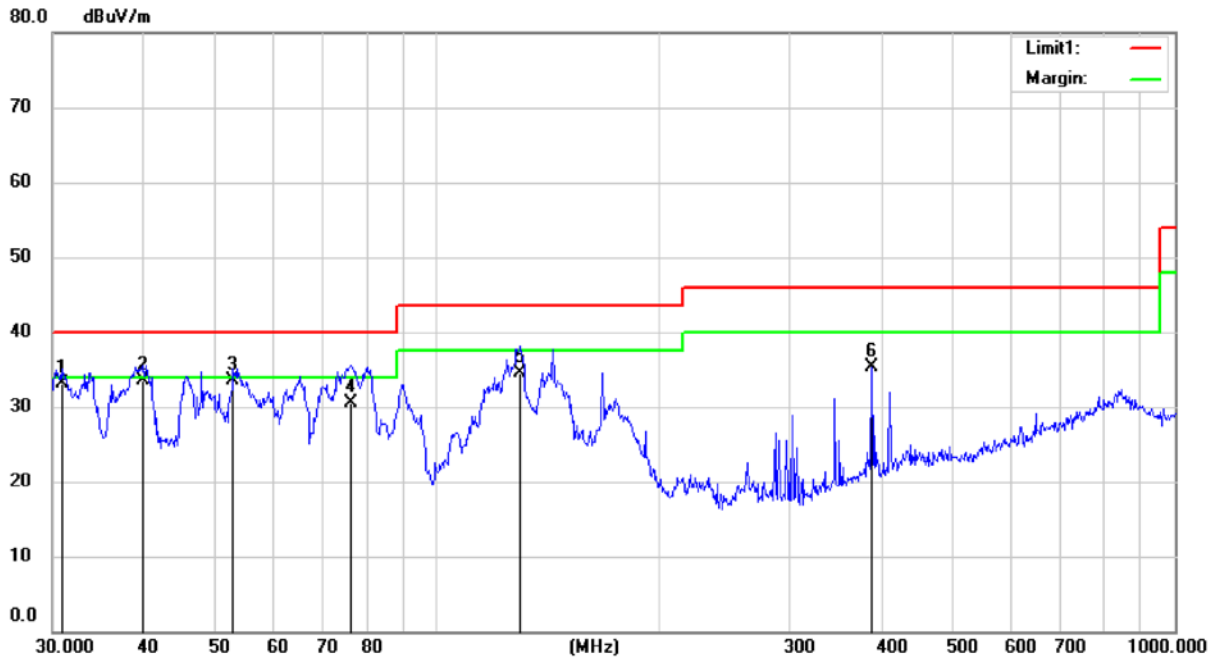

Site 3m Chamber #1

Polarization: **Vertical**

Temperature: 22 C

Limit: (RE)FCC PART 15 CLASS B

Power: DC 5V from PC

Humidity: 43 %

Mode: Working Mode

Note:

No.	Mk.	Freq.	Reading Level	Correct Factor	Measurement	Limit	Over	Antenna Height	Table Degree	
		MHz	dBuV	dB	dBuV/m	dBuV/m	dB	cm	degree	Comment
1		30.8805	47.63	-14.53	33.10	40.00	-6.90			
2	*	39.7670	46.54	-12.94	33.60	40.00	-6.40			
3		52.7600	45.45	-11.85	33.60	40.00	-6.40			
4		76.2442	44.97	-14.37	30.60	40.00	-9.40			
5		129.5244	48.86	-14.26	34.60	43.50	-8.90			
6		388.8432	42.10	-6.79	35.31	46.00	-10.69			

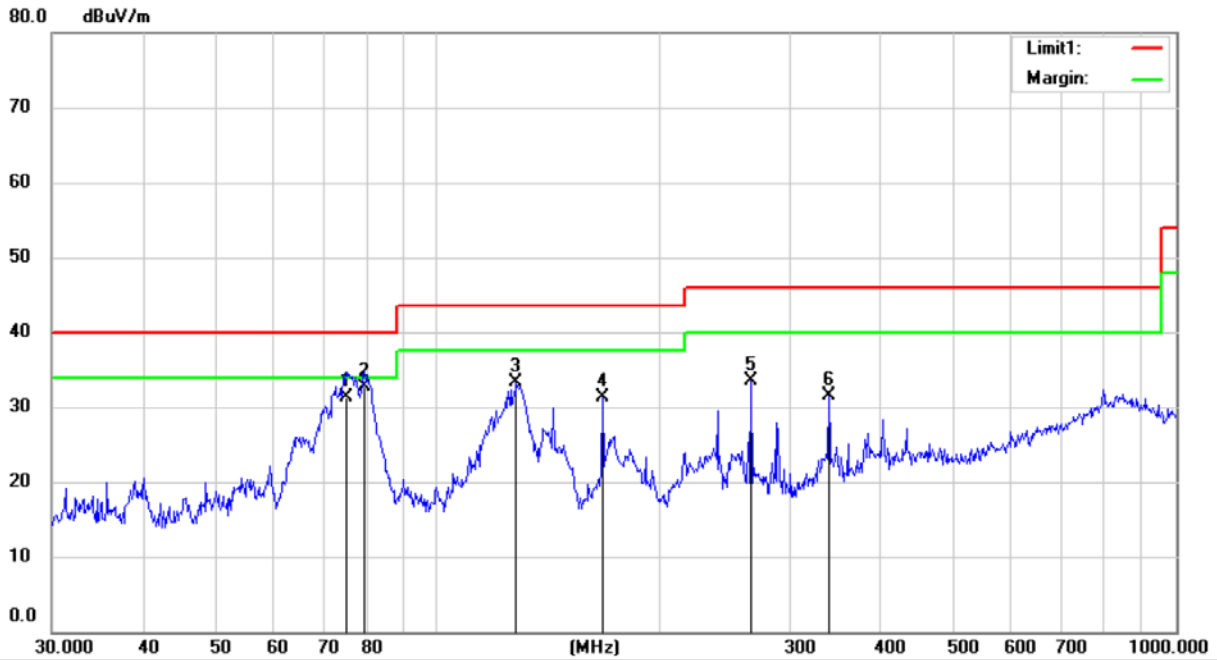

Site 3m Chamber #1 Polarization: *Horizontal* Temperature: 22 C
 Limit: (RE)FCC PART 15 CLASS B Power: DC 5V from PC Humidity: 43 %
 Mode: Working Mode
 Note:

No.	Mk.	Freq.	Reading Level	Correct Factor	Measurement	Limit	Over	Antenna Height	Table Degree	
		MHz	dBuV	dB	dBuV/m	dBuV/m	dB	cm	degree	Comment
1		75.3472	45.65	-14.25	31.40	40.00	-8.60			QP
2	*	79.6954	47.58	-14.88	32.70	40.00	-7.30			QP
3		127.9446	47.66	-14.30	33.36	43.50	-10.14			QP
4		167.6772	45.37	-14.12	31.25	43.50	-12.25			QP
5		266.3753	44.15	-10.68	33.47	46.00	-12.53			QP
6		339.4400	39.41	-7.82	31.59	46.00	-14.41			QP

6. RADIATED EMISSION MEASUREMENT (ABOVE 1GHz)

6.1. Block Diagram of Test Setup

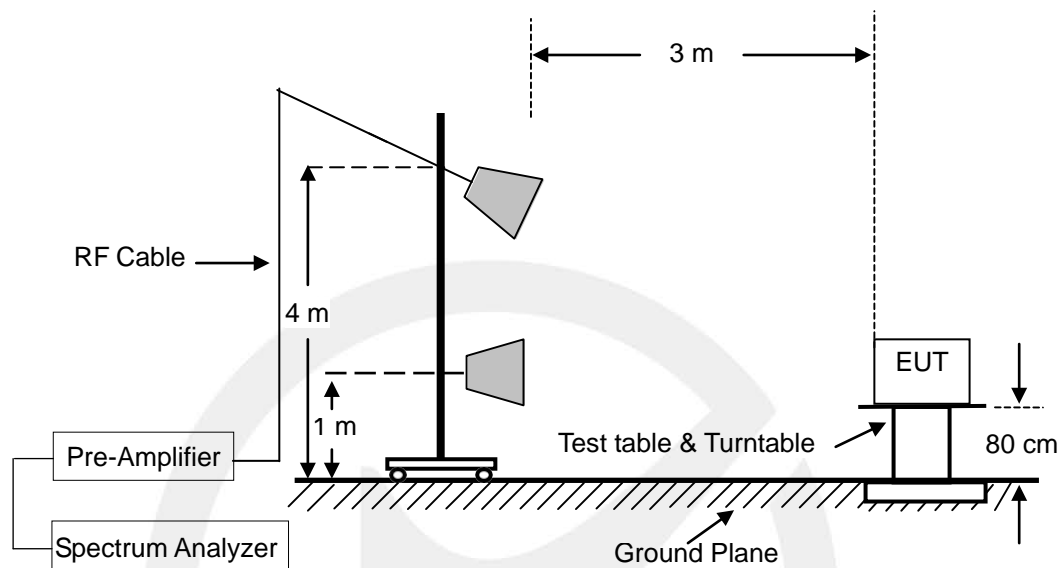

6.2. Radiated Limit

FCC Part 15, Subpart B, Class B

Frequency range GHz	Average limit dB(μ V/m)	Peak limit dB(μ V/m)
Above 1000	54	74

Note: The highest internal source of an EUT is defined as the highest frequency generated or used in the device or on which the EUT operates or tunes. If the highest frequency of the internal sources of the EUT is less than 1.705 MHz, the measurement shall only be made up to 30 MHz. If the highest frequency of the internal sources of the EUT is between 1.705 MHz and 108 MHz, the measurement shall only be made up to 1 GHz. If the highest frequency of the internal sources of the EUT is between 108 MHz and 500 MHz the measurement shall only be made up to 2 GHz. If the highest frequency of the internal sources of the EUT is between 500 MHz and 1 GHz, the measurement shall only be made up to 5 GHz. If the highest frequency of the internal sources of the EUT is above 1 GHz, the measurement shall be made up to 5 times the highest frequency or 40 GHz, whichever is less.

6.3. Test Procedure

The EUT was placed on a non-conductive table whose total height equaled 80cm. All units of equipment forming the system under test (includes the EUT as well as connected peripherals and associated equipment or devices) shall be arranged such that a nominal 0.1 m separation is achieved between the neighboring units. Where the mains cable supplied by the manufacturer is longer than 1 m, the excess should be folded at the centre into a bundle no longer than 0.4 m, so that its length is shortened to 1 m.

The EUT was set 3 meters away from the receiving antenna that was mounted on a non-conductive mast. The antenna can move up and down between 1 to 4 meters to find out the maximum emission level.

The turntable can rotate 360 degree to determine the position of the maximum emission level.

The initial testing identified the frequency that has the highest disturbance relative to the limit while operating the EUT in typical modes of operation and cable positions in a test setup representative of typical system configuration.

The identification of the frequency of highest emission with respect to the limit was found by investigating emissions at a number of significant frequencies. The probable frequency of maximum emission had been found and that the associated cable and EUT configuration and mode of operation had been identified.

The frequency range above 1GHz the measuring instrument use RBW=1 MHz and VBW=3 MHz with peak detector for peak values, and use RBW=1 MHz and VBW=10 Hz with peak detector for Average Values.

Test results were obtained from the following equation:

Emission level (dB μ V/m) = Antenna Factor - Amp Factor +Cable Loss + Reading

Margin (dB) = Emission Level (dB μ V/m) - Limit (dB μ V/m)

6.4. Measuring Results

PASS.

Temperature	:	21.9°C
Humidity	:	43%
Atmospheric Pressure	:	101kpa
Test Engineer	:	LEEY
Test Date	:	2022-2-17

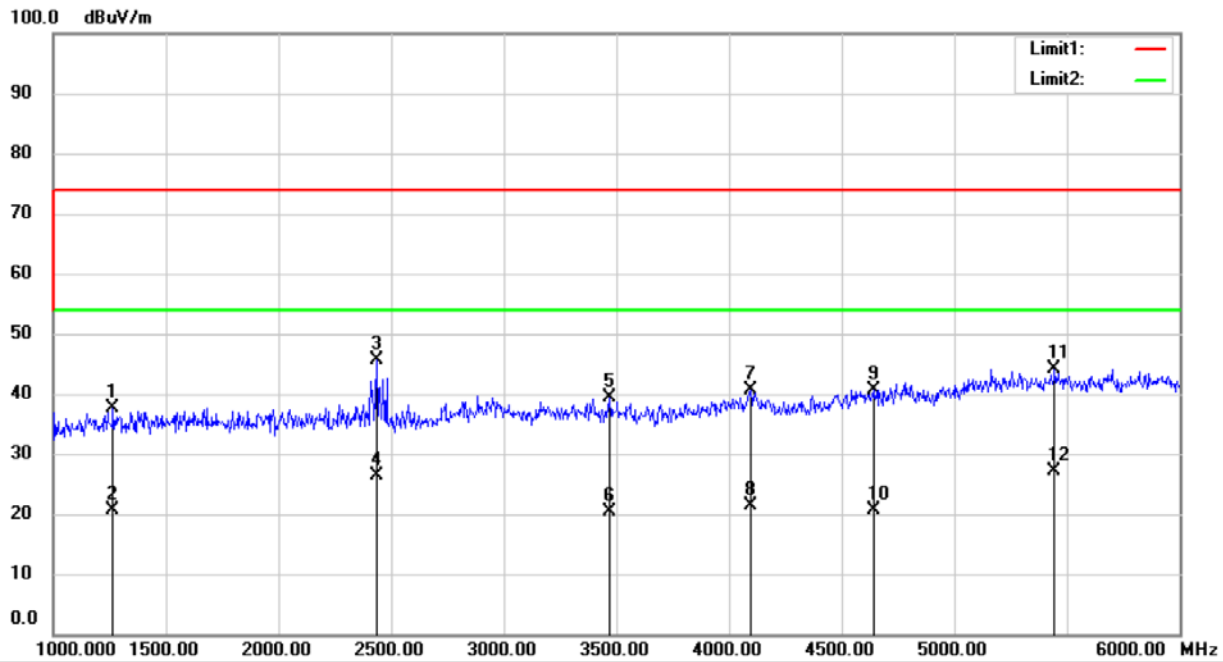

Site 3m Chamber #1

Polarization: *Horizontal*

Temperature: 21.9 C

Limit: (RE)FCC PART 15 CLASS B

Power: DC 5V from PC

Humidity: 43 %

Mode: Working mode

Note:

No.	Mk.	Freq.	Reading Level	Correct Factor	Measurement	Limit	Over	Antenna Height	Table Degree	
		MHz	dBuV	dB	dBuV/m	dBuV/m	dB	cm	degree	Comment
1	X	1266.250	59.75	-22.13	37.62	74.00	-36.38	peak		
2	X	1266.250	42.73	-22.13	20.60	54.00	-33.40	AVG		
3	X	2436.250	66.86	-21.12	45.74	74.00	-28.26	peak		
4	X	2436.250	47.62	-21.12	26.50	54.00	-27.50	AVG		
5	X	3472.500	57.69	-18.30	39.39	74.00	-34.61	peak		
6	X	3472.500	38.80	-18.30	20.50	54.00	-33.50	AVG		
7	X	4095.000	57.12	-16.57	40.55	74.00	-33.45	peak		
8	X	4095.000	37.87	-16.57	21.30	54.00	-32.70	AVG		
9	X	4641.875	55.36	-14.62	40.74	74.00	-33.26	peak		
10	X	4641.875	35.22	-14.62	20.60	54.00	-33.40	AVG		
11	X	5448.750	55.97	-11.91	44.06	74.00	-29.94	peak		
12	*	5448.750	39.01	-11.91	27.10	54.00	-26.90	AVG		

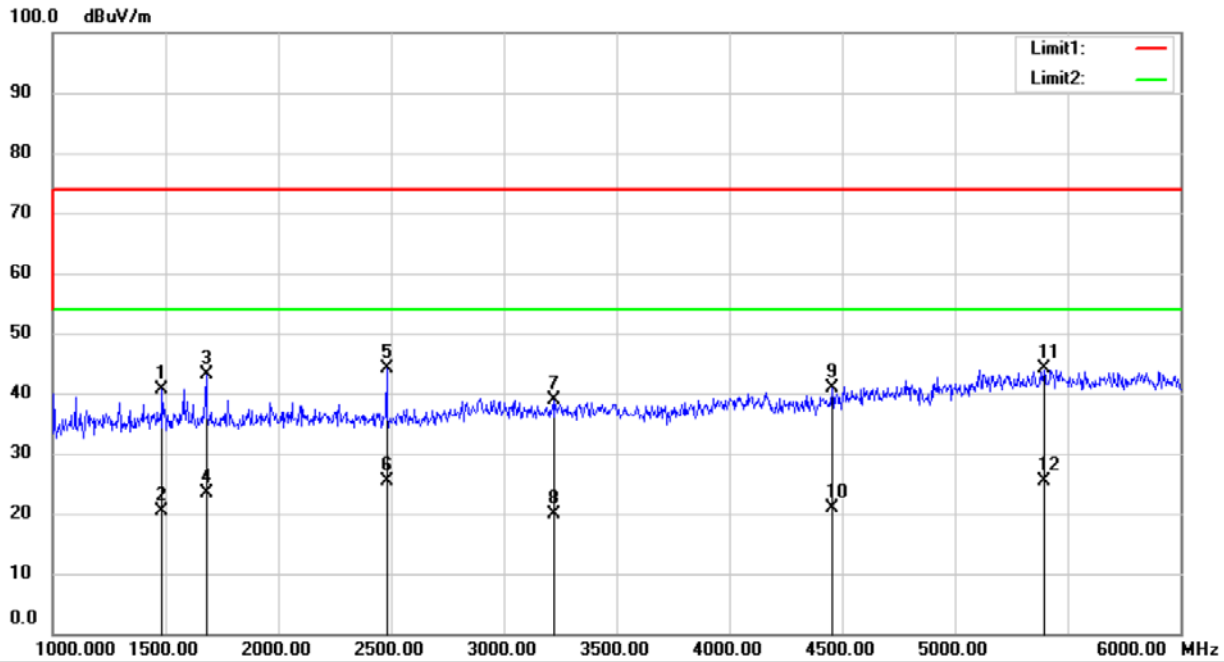

Site 3m Chamber #1

Polarization: *Vertical*

Temperature: 21.9 C

Limit: (RE)FCC PART 15 CLASS B

Power: DC 5V from PC

Humidity: 43 %

Mode: Working mode

Note:

No.	Mk.	Freq.	Reading Level	Correct Factor	Measurement	Limit	Over	Antenna Height	Table Degree	
		MHz	dBuV	dB	dBuV/m	dBuV/m	dB	cm	degree	Comment
1		1488.125	63.12	-22.47	40.65	74.00	-33.35			peak
2		1488.125	42.97	-22.47	20.50	54.00	-33.50			AVG
3		1680.000	65.55	-22.46	43.09	74.00	-30.91			peak
4		1680.000	45.86	-22.46	23.40	54.00	-30.60			AVG
5		2480.000	65.21	-21.02	44.19	74.00	-29.81			peak
6		2480.000	46.32	-21.02	25.30	54.00	-28.70			AVG
7		3221.250	57.50	-18.52	38.98	74.00	-35.02			peak
8		3221.250	38.32	-18.52	19.80	54.00	-34.20			AVG
9		4458.750	56.26	-15.37	40.89	74.00	-33.11			peak
10		4458.750	36.37	-15.37	21.00	54.00	-33.00			AVG
11		5398.125	56.06	-12.05	44.01	74.00	-29.99			peak
12	*	5398.125	37.45	-12.05	25.40	54.00	-28.60			AVG

7. PHOTOGRAPHS

7.1. Photos of Conducted Emission Measurement

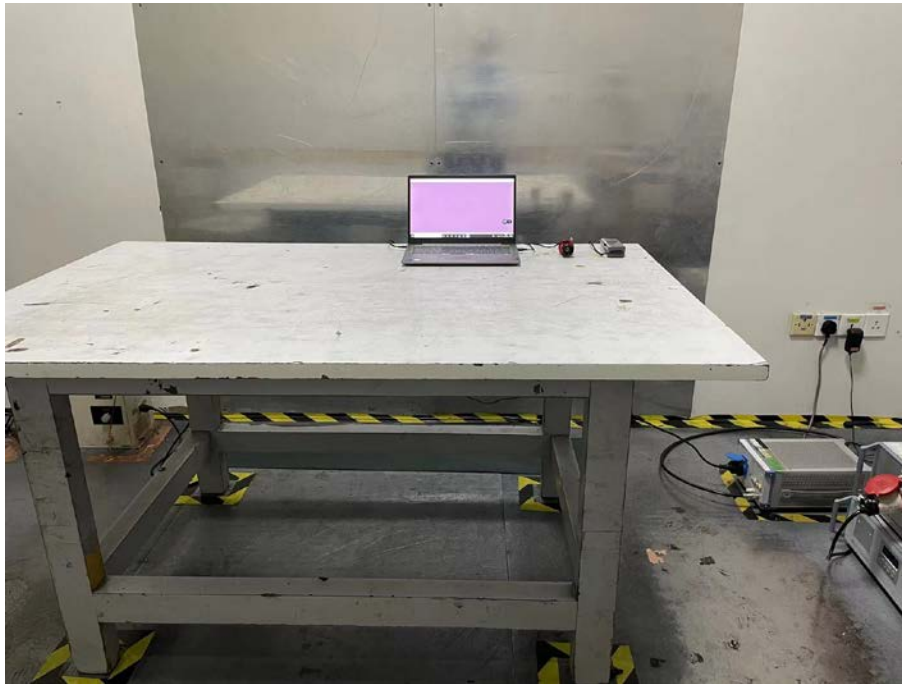

7.2. Photos of Radiation Emission Measurement Spurious Emission Test Setup (Below 1GHz)

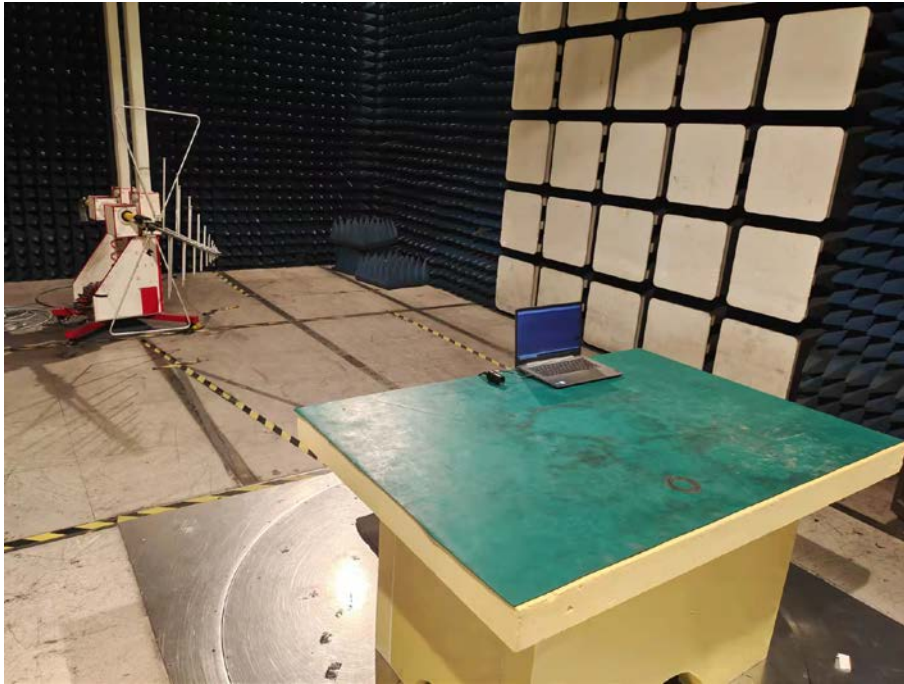

Spurious Emission Test Setup (Above 1GHz)

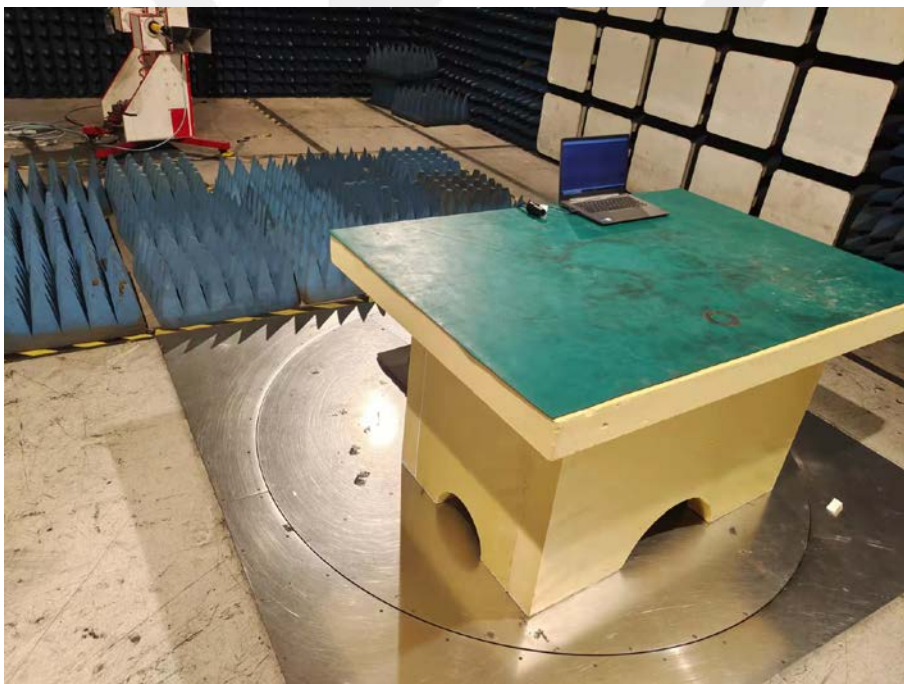

APPENDIX A: Label Requirements

(1) Receivers associated with the operation of a licensed radio service, e.g., FM broadcast under part 73 of this chapter, land mobile operation under part 90 of this chapter, etc., shall bear the following statement in a conspicuous location on the device:

This device complies with part 15 of the FCC Rules. Operation is subject to the condition that this device does not cause harmful interference.

(2) A stand-alone cable input selector switch, shall bear the following statement in a conspicuous location on the device:

This device complies with part 15 of the FCC Rules for use with cable television service.

(3) All other devices shall bear the following statement in a conspicuous location on the device:

This device complies with part 15 of the FCC Rules. Operation is subject to the following two conditions: (1) This device may not cause harmful interference, and (2) this device must accept any interference received, including interference that may cause undesired operation.

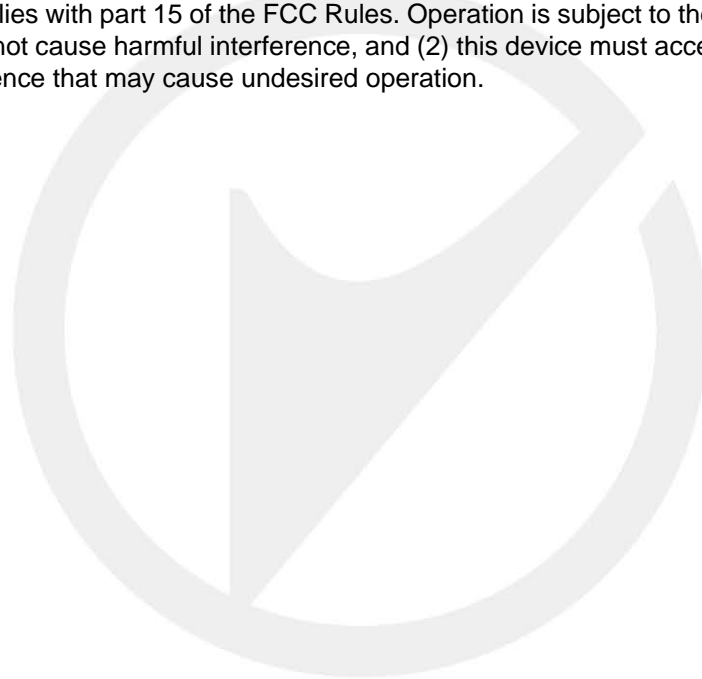

APPENDIX B: Warning Statement

(a) For a Class A digital device or peripheral, the instructions furnished the user shall include the following or similar statement, placed in a prominent location in the text of the manual:

NOTE: This equipment has been tested and found to comply with the limits for a Class A digital device, pursuant to part 15 of the FCC Rules. These limits are designed to provide reasonable protection against harmful interference when the equipment is operated in a commercial environment. This equipment generates, uses, and can radiate radio frequency energy and, if not installed and used in accordance with the instruction manual, may cause harmful interference to radio communications. Operation of this equipment in a residential area is likely to cause harmful interference in which case the user will be required to correct the interference at his own expense.

(b) For a Class B digital device or peripheral, the instructions furnished the user shall include the following or similar statement, placed in a prominent location in the text of the manual:

NOTE: This equipment has been tested and found to comply with the limits for a Class B digital device, pursuant to part 15 of the FCC Rules. These limits are designed to provide reasonable protection against harmful interference in a residential installation. This equipment generates uses and can radiate radio frequency energy and, if not installed and used in accordance with the instructions, may cause harmful interference to radio communications. However, there is no guarantee that interference will not occur in a particular installation. If this equipment does cause harmful interference to radio or television reception, which can be determined by turning the equipment off and on, the user is encouraged to try to correct the interference by one or more of the following measures:

- Reorient or relocate the receiving antenna.
- Increase the separation between the equipment and receiver.
- Connect the equipment into an outlet on a circuit different from that to which the receiver is connected.
- Consult the dealer or an experienced radio/TV technician for help.

APPENDIX C: Photos of EUT







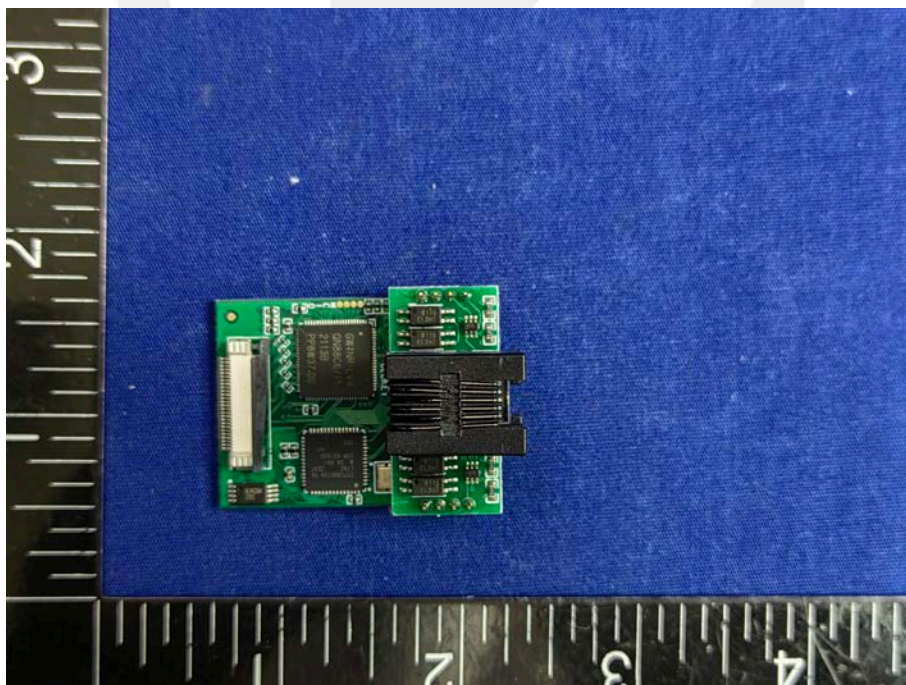
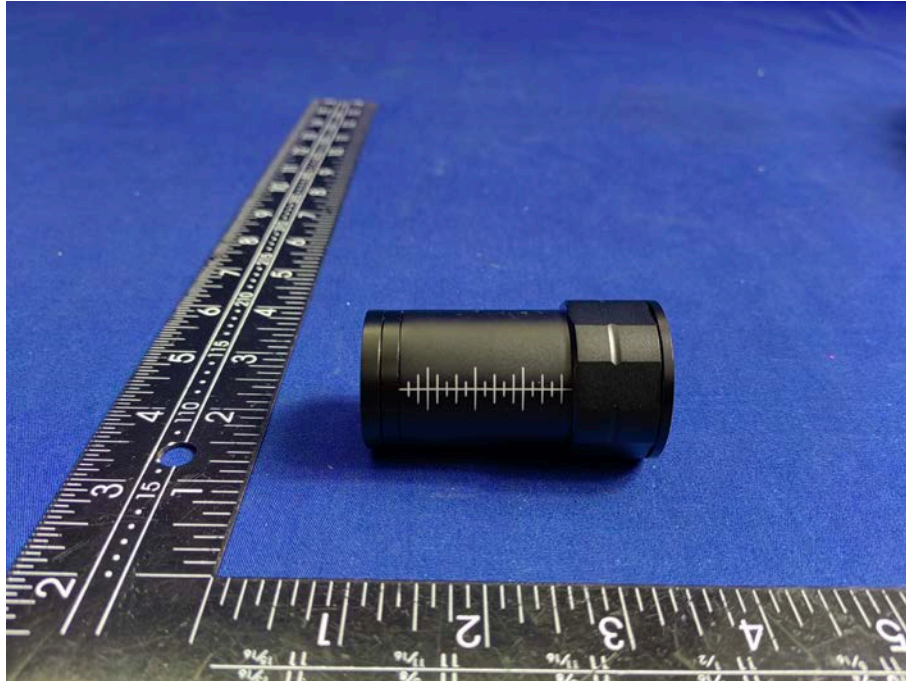

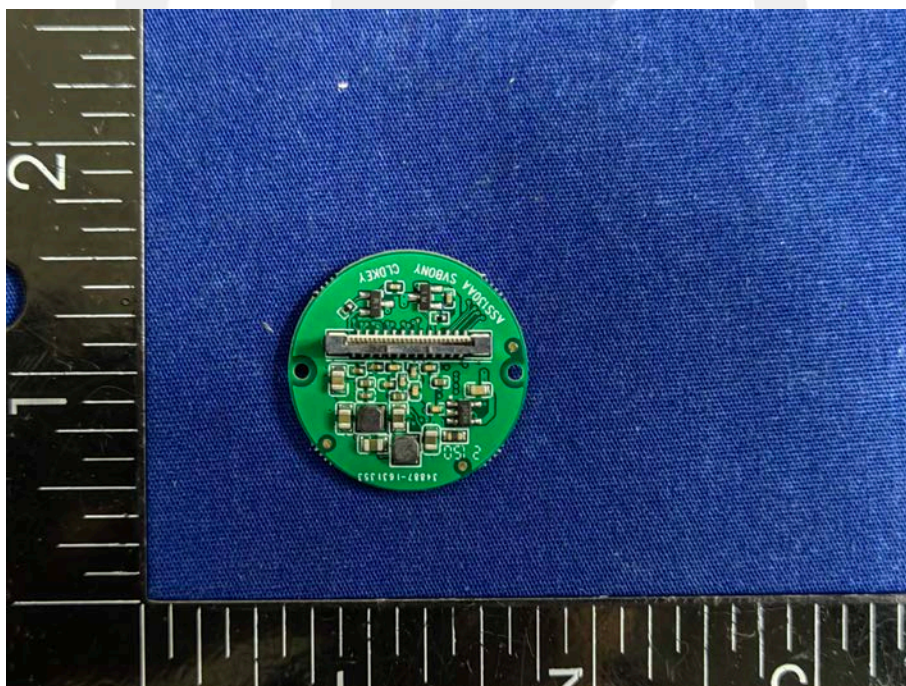
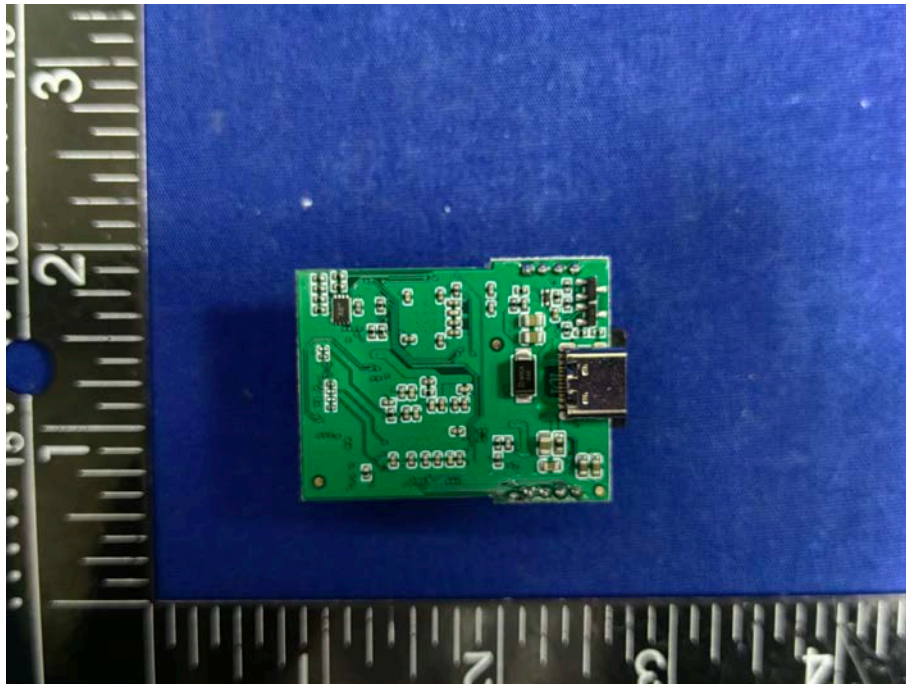

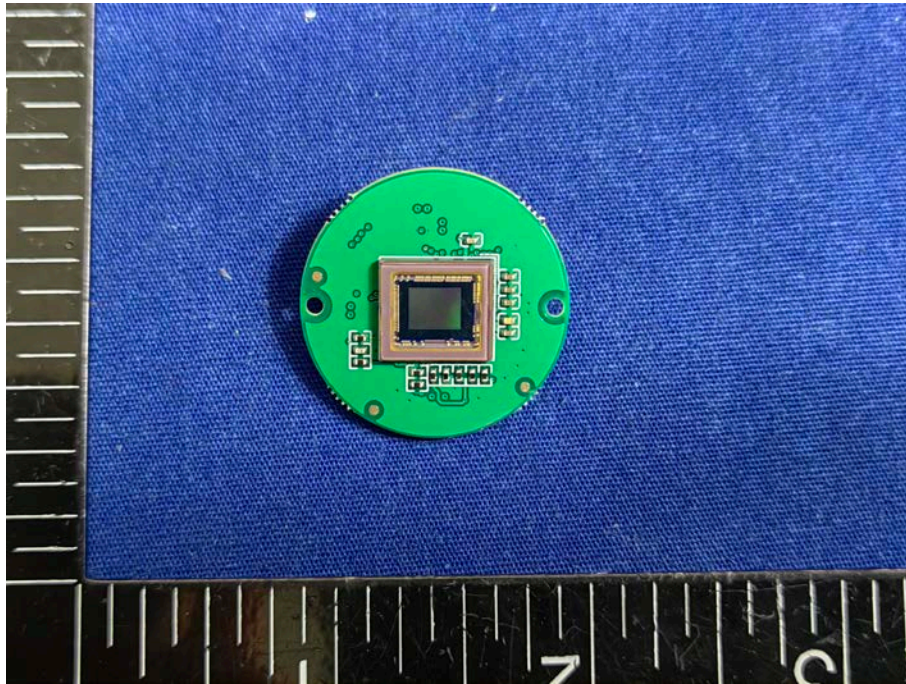

-----The end-----