



FCC&IC TEST REPORT

FCC ID: 2A3MU-FC2A

On Behalf of

Shanghai EFIX Geomatics Co.,Ltd

Handheld GNSS Data Collector

Model No.: FC2

Prepared for : Shanghai EFIX Geomatics Co.,Ltd
Address : Building 1, 158 Shuanglian Road, Qingpu District, Shanghai

Prepared By : Shenzhen Alpha Product Testing Co., Ltd.
Address : Building i, No.2, Lixin Road, Fuyong Street, Bao'an District, 518103,
Shenzhen, Guangdong, China

Report Number : A2311081-C01-R21
Date of Receipt : December 25, 2023
Date of Test : December 25, 2023 - April 8, 2024
Date of Report : April 8, 2024
Version Number : V0
Test Result : Pass

TABLE OF CONTENTS

<u>Description</u>	<u>Page</u>
1 TEST SUMMARY	5
2 GENERAL INFORMATION	6
2.1 GENERAL DESCRIPTION OF EUT	6
2.2 RELATED SUBMITTAL(S) / GRANT (S)	8
2.3 TEST METHODOLOGY	8
2.4 TEST FACILITY.....	8
2.5 ACCESSORIES OF DEVICE (EUT)	8
2.6 TESTED SUPPORTING SYSTEM DETAILS	8
2.7 TEST CONDITIONS.....	8
2.8 MEASUREMENT UNCERTAINTY	9
3 TEST INSTRUMENTS LIST.....	10
4 SYSTEM TEST CONFIGURATION	11
4.1 TEST MODE	11
4.2 CONFIGURATION OF TESTED SYSTEM.....	11
4.3 CONDUCTED AV OUTPUT POWER	12
4.4 PEAK-TO-AVERAGE RATIO	14
4.5 OCCUPY BANDWIDTH.....	17
4.6 MODULATION CHARACTERISTIC.....	24
4.7 OUT OF BAND EMISSION AT ANTENNA TERMINALS	24
4.8 ERP, EIRP MEASUREMENT	37
4.9 FIELD STRENGTH OF SPURIOUS RADIATION MEASUREMENT	48
4.10 FREQUENCY STABILITY V.S. TEMPERATURE MEASUREMENT	55
4.11 FREQUENCY STABILITY V.S. VOLTAGE MEASUREMENT	59
5 TEST SETUP PHOTO.....	63

TEST REPORT DECLARATION

Applicant : Shanghai EFIX Geomatics Co.,Ltd
 Address : Building 1, 158 Shuanglian Road, Qingpu District, Shanghai
 Manufacturer : Shanghai EFIX Geomatics Co.,Ltd
 Address : Building 1, 158 Shuanglian Road, Qingpu District, Shanghai
 EUT Description : Handheld GNSS Data Collector

(A) Model No. : FC2

(B) Trademark : 

Measurement Standard Used:

FCC CFR Title 47 Part 2
FCC CFR Title 47 Part 22 Subpart H
FCC CFR Title 47 Part 24 Subpart E
FCC CFR Title 47 Part 27

The device described above is tested by Shenzhen Alpha Product Testing Co., Ltd. to determine the maximum emission levels emanating from the device. The maximum emission levels are compared to the FCC Part 15 Subpart C limits both conducted and radiated emissions. The test results are contained in this test report and Shenzhen Alpha Product Testing Co., Ltd. is assumed of full responsibility for the accuracy and completeness of these tests.

After the test, our opinion is that EUT compliance with the requirement of the above standards.

This report applies to above tested sample only. This report shall not be reproduced in parts without written approval of Shenzhen Alpha Product Testing Co., Ltd.

Tested by (name + signature).....: Yannis Wen
 Project Engineer



Approved by (name + signature).....: Reak Yang
 Project Manager



Date of issue..... : April 8, 2024

Revision History

Revision	Issue Date	Revisions	Revised By
V0	April 8, 2024	Initial released Issue	Yannis Wen

1 Test Summary

Test Item	Section in CFR 47	Result
RF Exposure (SAR)	Part 1.1307 Part 2.1093	Pass* (Please refer to SAR Report)
RF Output Power	Part 2.1046 Part 22.913 (a)(2) Part 24.232 (c) Part 27.50(d)(4)	Pass
Peak-to-Average Ratio	Part 2.1046 Part 22.913(d) Part 24.232 (d) Part 27.50(d)(5)	Pass
Modulation Characteristics	Part 2.1047	Pass
99% & -26 dB Occupied Bandwidth	Part 2.1049 Part 22.917 Part 24.238 Part 27.53(h)	Pass
Spurious Emissions at Antenna Terminal	Part 2.1051 Part 22.917 (a) Part 24.238 (a) Part 27.53(h)	Pass
Field Strength of Spurious Radiation	Part 2.1053 Part 22.917 (a) Part 24.238 (a) Part 27.53(h)	Pass
Out of band emission, Band Edge	Part 22.917 (a) Part 24.238 (a) Part 27.53(h)	Pass
Frequency stability vs. temperature	Part 2.1055(a)(1)(b)	Pass
Frequency stability vs. voltage	Part 2.1055(d)(1)(2)	Pass

Note: 1. Pass: The EUT complies with the essential requirements in the standard.

2. The conclusion of this test report is judged by actual test data without considering measurement uncertainty.

2 General Information

2.1 General Description of EUT

Description/PMN	: Handheld GNSS Data Collector
Model Number	: FC2
Diff	: N/A
Test Voltage	: DC 5V from adapter and DC 3.8V from battery.
Support Networks	: GSM, GPRS, EGPRS, WCDMA
Support Bands	: GSM850, PCS1900, WCDMA Band V, WCDMA Band IV, WCDMA Band II
TX Frequency	: GSM850: 824.20MHz-848.80MHz PCS1900: 1850.20MHz-1909.80MHz WCDMA Band V: 826.40MHz -846.60MHz WCDMA Band II: 1852.40MHz -1907.60MHz WCDMA Band IV: 1710MHz -1755MHz
GPRS Class	: 12
EGPRS Class	: 12
Modulation type	: GSM/GPRS: GMSK EGPRS: GMSK/8PSK WCDMA Band II/IV/V: QPSK
Antenna type	: Internal antenna
Antenna gain	: Maximum Gain is -4.7dBi for GSM 850 Maximum Gain is -4.1dBi for PCS1900 Maximum Gain is -4.7dBi for WCDMA Band V Maximum Gain is -4.1dBi for WCDMA Band IV Maximum Gain is -5.06dBi for WCDMA Band II (Antenna information is provided by applicant.) There is WWAN diversity antenna inside the product, which is only for receiving function.
Software version	: V1.0
Hardware version	: V1.0

Remark: 1.The worst-case simultaneous transmission configuration was evaluated with no non-compliance found. Results in this report are only for 2G and 3G function, and there is no other transmitter involved.

Operation Frequency List:

GSM 850		PCS1900		WCDMA Band V		WCDMA Band II	
Channel	Frequency (MHz)	Channel	Frequency (MHz)	Channel	Frequency (MHz)	Channel	Frequency (MHz)
128	824.20	512	1850.20	4132	826.40	9262	1852.40
129	824.40	513	1850.40	4133	826.60	9263	1852.60
· ∴	· ∴	· ∴	· ∴	· ∴	· ∴	· ∴	· ∴
189	836.40	660	1879.80	4181	836.20	9399	1879.80
190	836.60	661	1880.00	4182	836.40	9400	1880.00
191	836.80	662	1880.20	4183	836.60	9401	1880.20
· ∴	· ∴	· ∴	· ∴	· ∴	· ∴	· ∴	· ∴
250	848.60	809	1909.60	4232	846.40	9537	1907.40
251	848.80	810	1909.80	4233	846.60	9538	1907.60

Regards to the operating frequency range over 10 MHz, the Lowest frequency, the middle frequency, and the highest frequency of channel were selected to perform the test, and the selected channel see below:

Final test channel:

GSM 850		PCS1900		WCDMA Band V		WCDMA Band II	
Channel	Frequency (MHz)	Channel	Frequency (MHz)	Channel	Frequency (MHz)	Channel	Frequency (MHz)
128	824.20	512	1850.20	4132	826.40	9262	1852.40
190	836.60	661	1880.00	4183	836.60	9400	1880.00
251	848.80	810	1909.80	4233	846.60	9538	1907.60
WCDMA Band IV							
Channel		Frequency (MHz)					
1312		1712.4					
1450		1740.0					
1513		1752.6					

2.2 Related Submittal(s) / Grant (s)

This submittal(s) (test report) is filing to comply with Section Part 2, Part 22 subpart H, Part 24 subpart E, Part 27 subpart C of the FCC CFR 47, KDB 971168 D01 v03r01 and ANSI C63.26.

2.3 Test Methodology

Both conducted and radiated testing were performed according to the procedures document on TIA/EIA 603 ANSI C63.26 and FCC CFR 47.1046, 2.1047, 2.1049, 2.1051, 2.1053, 2.1055 and 2.1057

2.4 Test Facility

Shenzhen Alpha Product Testing Co., Ltd
Building i, No.2, Lixin Road, Fuyong Street, Bao'an District, 518103, Shenzhen, Guangdong, China

June 21, 2018 File on Federal Communication Commission
Registration Number: 293961

July 25, 2017 Certificated by IC
Registration Number: 12135A

2.5 Accessories of Device (EUT)

Accessories 1 : AC Adapter
Manufacturer : EDAC POWER Electronics Co., Ltd
Model : EA1012AVRU-050
Ratings : Input: 100-240Vac~50/60Hz 1.0A
Output: 5.0V=2.4A

2.6 Tested Supporting System Details

No.	Description	Manufacturer	Model	Serial Number	Certification or SDoC
--	--	--	--	--	--

2.7 Test Conditions

Items	Required	Actual
Temperature range:	15-35°C	24°C
Humidity range:	25-75%	56%
Pressure range:	86-106kPa	98kPa

2.8 Measurement Uncertainty

Item	Uncertainty
Uncertainty for Power point Conducted Emissions Test	2.74dB
Uncertainty for Radiation Emission test in 3m chamber (below 30MHz)	2.13 dB(Polarize: V)
	2.57dB(Polarize: H)
Uncertainty for Radiation Emission test in 3m chamber (30MHz to 1GHz)	3.77dB(Polarize: V)
	3.80dB(Polarize: H)
Uncertainty for Radiation Emission test in 3m chamber (1GHz to 25GHz)	4.16dB(Polarize: H)
	4.13dB(Polarize: V)
Uncertainty for radio frequency	5.4×10 ⁻⁸
Uncertainty for conducted RF Power	0.37dB
Uncertainty for temperature	0.2°C
Uncertainty for humidity	1%
Uncertainty for DC and low frequency voltages	0.06%

3 Test Instruments list

Equipment	Manufacture	Model No.	Firmware version	Serial No.	Last cal.	Cal Interval
9*6*6 anechoic chamber	CHENYU	9*6*6	/	N/A	2022.05.17	3Year
Spectrum analyzer	ROHDE&SCHWARZ	FSV40-N	2.3	102137	2023.08.16	1Year
Spectrum analyzer	Agilent	N9020A	A.14.16	MY499100060	2023.08.16	1Year
Receiver	ROHDE&SCHWARZ	ESR	2.28 SP1	1316.3003K03-102082-Wa	2023.08.16	1Year
Receiver	R&S	ESCI	4.42 SP1	101165	2023.08.16	1Year
Bilog Antenna	Schwarzbeck	VULB 9168	/	VULB 9168#627	2023.08.28	1Year
Horn Antenna	SCHWARZBECK	BBHA 9120 D	/	2106	2023.08.19	1Year
Loop Antenna	SCHWARZBECK	FMZB 1519B	/	00128	2023.08.19	1Year
RF Cable	Resenberger	Cable 1	/	RE1	2023.08.16	1Year
RF Cable	Resenberger	Cable 2	/	RE2	2023.08.16	1Year
RF Cable	Resenberger	Cable 3	/	CE1	2023.08.16	1Year
Pre-amplifier	HP	HP8347A	/	2834A00455	2023.08.16	1Year
Pre-amplifier	Agilent	8449B	/	3008A02664	2023.08.16	1Year
L.I.S.N.#1	Schwarzbeck	NSLK8126	/	8126-466	2023.08.16	1Year
L.I.S.N.#2	ROHDE&SCHWARZ	ENV216	/	101043	2023.08.16	1Year
Horn Antenna	SCHWARZBECK	BBHA 9170	/	00946	2023.08.19	1Year
Preamplifier	SKET	LNPA_1840-50	/	SK2018101801	2023.08.16	1 Year
Power Meter	Agilent	E9300A	/	MY41496628	2023.08.16	1 Year
Power Sensor	DARE	RPR3006W	/	15100041SNO91	2023.08.16	1 Year
Temp. & Humid. Chamber	Teelong	TL-HW408S	/	TL-20191205-01	2023.07.25	1 Year
Switching Mode Power Supply	JUNKE	JK12010S	/	20140927-6	2023.08.16	1 Year
Adjustable attenuator	MWRFtest	N/A	/	N/A	N/A	N/A
10dB Attenuator	Mini-Circuits	DC-6G	/	N/A	N/A	N/A

Software Information

Test Item	Software Name	Manufacturer	Version
RE	EZ-EMC	EZ	Alpha-3A1
CE	EZ-EMC	EZ	Alpha-3A1

4 System test configuration

4.1 Test mode

During all testing, EUT is in link mode with base station emulator at maximum power level. The spurious emission measurements were carried out in semi-anechoic chamber with 3-meter test range, and EUT is rotated on three test planes to find out the worst emission.

Test modes		
Band	Radiated	Conducted
GSM 850	<ul style="list-style-type: none"> ■ GSM link ■ GPRS 1 link ■ EPRS 1 link 	<ul style="list-style-type: none"> ■ GSM link ■ GPRS 1 link ■ EGPRS 1 link
PCS 1900	<ul style="list-style-type: none"> ■ GSM link ■ GPRS 1 link ■ EGPRS 1 link 	<ul style="list-style-type: none"> ■ GSM link ■ GPRS 1 link ■ EGPRS 1 link
WCDMA II	<ul style="list-style-type: none"> ■ RMC 12.2Kbps link 	<ul style="list-style-type: none"> ■ RMC 12.2Kbps link
WCDMA Band IV	<ul style="list-style-type: none"> ■ RMC 12.2Kbps link 	<ul style="list-style-type: none"> ■ RMC 12.2Kbps link
WCDMA Band V	<ul style="list-style-type: none"> ■ RMC 12.2Kbps link 	<ul style="list-style-type: none"> ■ RMC 12.2Kbps link

Note: The maximum power levels are GSM mode for GMSK link, GPRS multi-slot class 8 mode for GMSK link, EGPRS multi-slot class 8 mode for 8PSK link, RMC12.2Kbps mode for WCDMA Band V/II. Only these modes were used for all tests.

4.2 Configuration of Tested System

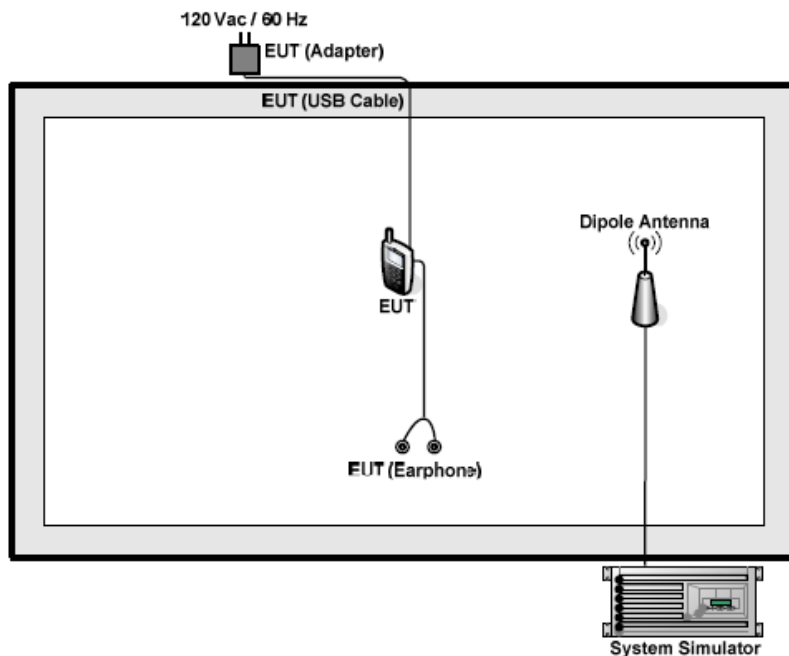

4.3 Conducted AV Output Power

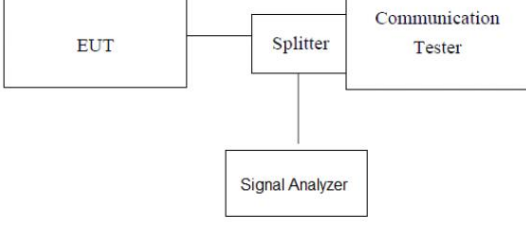
Test Requirement:	FCC part22.913(a) and FCC part24.232(b), FCC part 27.50 (d)(4)
Test Method:	FCC part2.1046
Limit:	GSM850, WCDMA Band V: 7W(38.45dbm) PCS1900, WCDMA Band II: 2W(33.01dbm) WCDMA Band IV: 1W(30.00dbm)
Test setup:	 <pre> graph LR EUT[EUT] --- Splitter[Splitter] Splitter --- CT[Communication Tester] Splitter --- SA[Signal Analyzer] </pre> <p><i>Note: Measurement setup for testing on Antenna connector</i></p>
Test Procedure:	<ol style="list-style-type: none"> 1. The transmitter output port was connected to base station. 2. The RF output of EUT was connected to the Signal Analyzer by RF cable and attenuator, the path loss was compensated to the results for each measurement. 3. Set EUT at maximum power through base station. 4. Select lowest, middle, and highest channels for each band and different modulation. 5. Measure the maximum burst average power.
Test Instruments:	Refer to section 5.0 for details
Test mode:	Refer to section 6.1 for details
Test results:	Pass

Measurement Data

Conducted Burst Power (dBm)						
Band	GSM850			PCS1900		
Channel	128	190	251	512	661	810
Frequency	824.20	836.60	848.80	1850.20	1880.00	1909.80
GSM (GMSK, 1 TX slot)	32.10	31.47	32.80	30.84	29.46	30.73
GPRS (GMSK, 1 TX slot)	30.85	29.44	30.58	27.47	27.82	28.29
GPRS (GMSK, 2 TX slot)	29.81	29.23	31.29	27.63	27.72	28.00
GPRS (GMSK, 3 TX slot)	28.66	29.98	30.14	29.62	29.81	29.65
GPRS (GMSK, 4 TX slot)	29.86	28.65	28.04	28.81	28.31	28.69
EGPRS (8PSK, 1 TX slot)	27.94	28.37	28.56	27.97	28.46	28.35
EGPRS (8PSK, 2 TX slot)	27.15	27.28	25.90	27.68	27.32	25.85
EGPRS (8PSK, 3 TX slot)	27.71	26.44	26.53	27.09	26.48	26.58
EGPRS (8PSK, 4 TX slot)	27.72	26.88	26.42	27.50	27.22	26.24

Burst Average Power (dBm)						
Band	WCDMA Band II			WCDMA Band V		
Channel	9262	9400	9538	4132	4183	4233
Frequency	1852.4	1880.0	1907.6	826.4	836.6	846.6
RMC 12.2Kbps	23.42	23.13	23.40	23.15	23.30	23.46
HSDPA Subtest-1	22.92	23.36	23.57	22.87	23.50	23.57
HSDPA Subtest-2	22.79	23.53	21.57	23.50	23.16	21.73
HSDPA Subtest-3	23.11	22.17	21.70	23.11	22.29	21.36
HSDPA Subtest-4	23.64	23.23	22.01	22.81	23.50	22.36
HSUPA Subtest-1	23.48	21.45	21.75	22.74	22.06	21.98
HSUPA Subtest-2	23.55	23.96	22.27	23.00	23.75	22.08
HSUPA Subtest-3	23.65	22.09	21.60	22.82	22.29	21.81
HSUPA Subtest-4	23.72	23.48	21.78	23.49	23.71	21.58
HSUPA Subtest-5	22.80	21.90	21.36	23.04	21.84	21.46

Burst Average Power (dBm)			
Band	WCDMA Band IV		
Channel	1312	1450	1513
Frequency	1712.4	1740.0	1752.6
RMC 12.2Kbps	23.17	23.13	22.90
HSDPA Subtest-1	23.28	23.55	22.80
HSDPA Subtest-2	22.86	23.26	21.97
HSDPA Subtest-3	23.59	21.98	22.12
HSDPA Subtest-4	23.68	23.35	22.22
HSUPA Subtest-1	23.36	21.77	21.88
HSUPA Subtest-2	22.96	23.87	22.38
HSUPA Subtest-3	22.71	21.73	21.98
HSUPA Subtest-4	23.38	23.61	22.02
HSUPA Subtest-5	22.91	22.25	21.27

4.4 Peak-to-Average Ratio

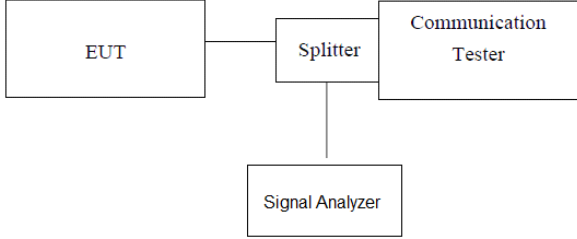
Test Requirement:	Part 22.913(d), FCC part24.232(d), FCC part27.50(d)(5),
Test Method:	FCC part2.1046
Limit:	13db
Test setup:	 <p><i>Note: Measurement setup for testing on Antenna connector</i></p>
Test Procedure:	<ol style="list-style-type: none"> 1. The transmitter output port was connected to base station. 2. The RF output of EUT was connected to the Signal Analyzer by RF cable and attenuator, the path loss was compensated to the results for each measurement. 3. Set EUT at maximum power through base station. 4. Select lowest, middle, and highest channels for each band and different modulation. 5. Measure the maximum burst average power. 6. Record the maximum peak-to-average ratio value.
Test Instruments:	Refer to section 5.0 for details
Test mode:	Refer to section 6.1 for details
Test results:	Pass

Measurement data

Test mode	Peak to Average Ratio (dB)			Limit (dB)	Result
	Low Ch.	Middle Ch.	High Ch.		
WCDMA Band II	3.12	3.04	2.85	13	PASS
WCDMA Band IV	3.14	3.11	3.12	13	PASS
WCDMA Band V	2.75	2.93	2.95	13	PASS

Test Mode: WCDMA Band II Low Ch. Test Mode: WCDMA Band IV Low Ch.

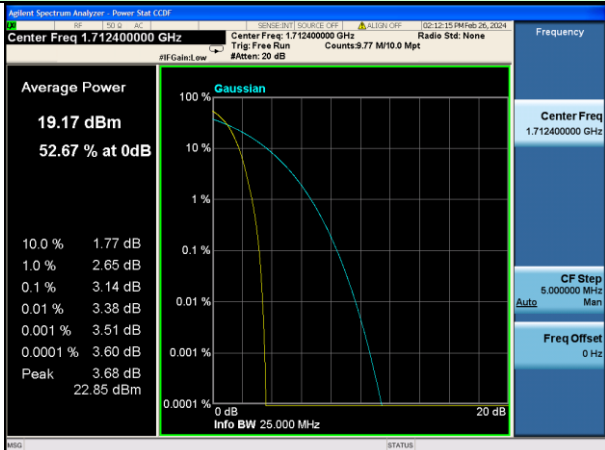
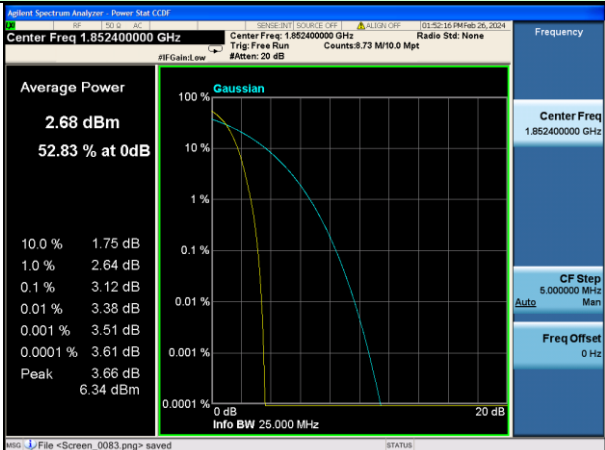

Middle Ch. Middle Ch.

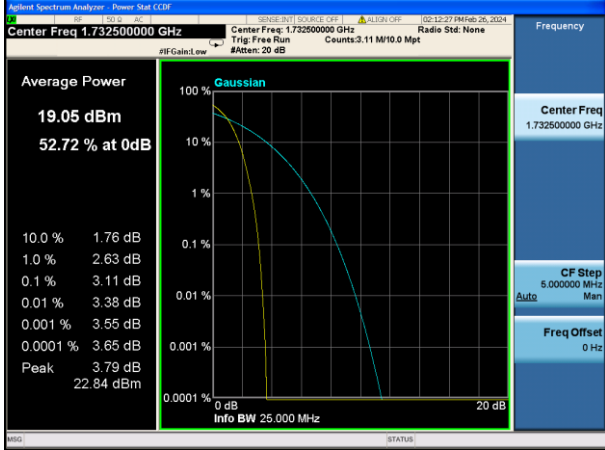
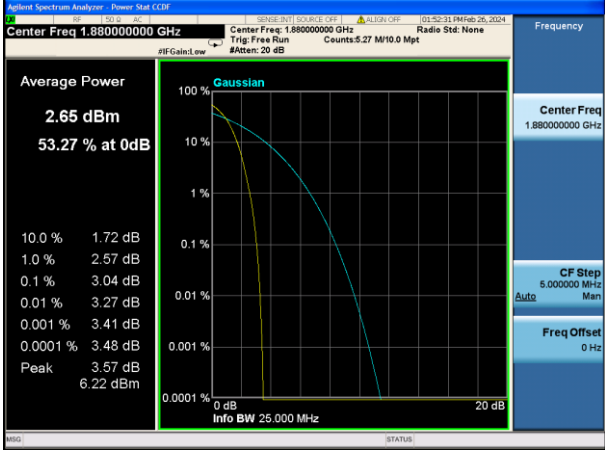

High Ch. High Ch.

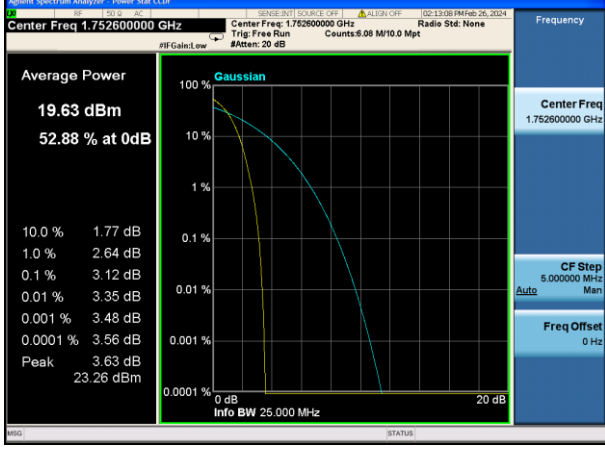
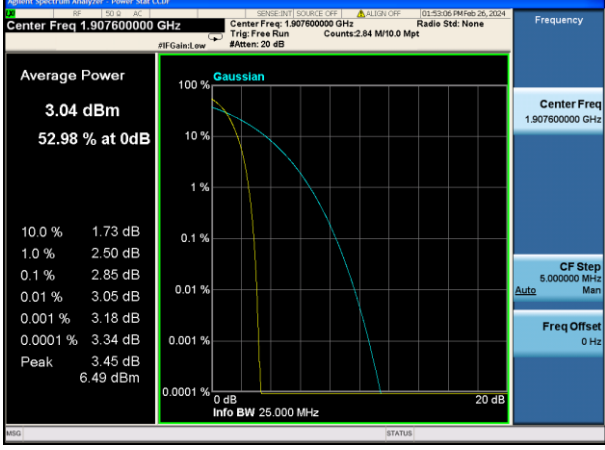

Test Mode: WCDMA Band V
Low Ch.

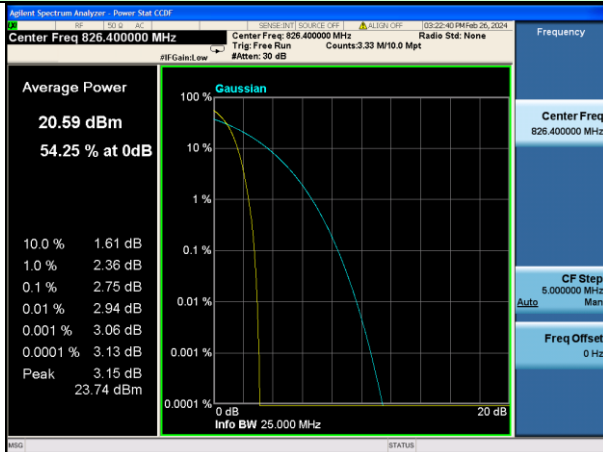

Middle Ch.

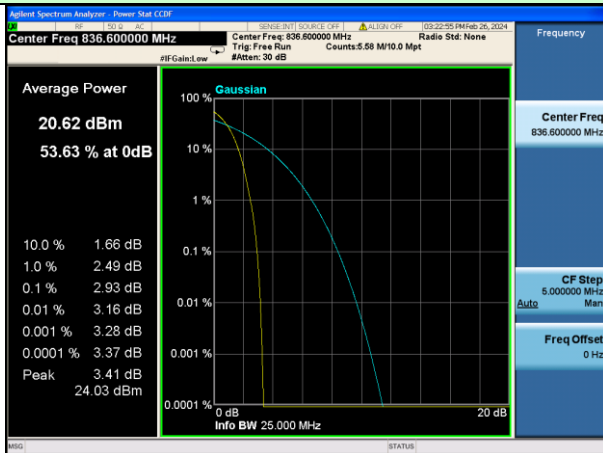

High Ch.

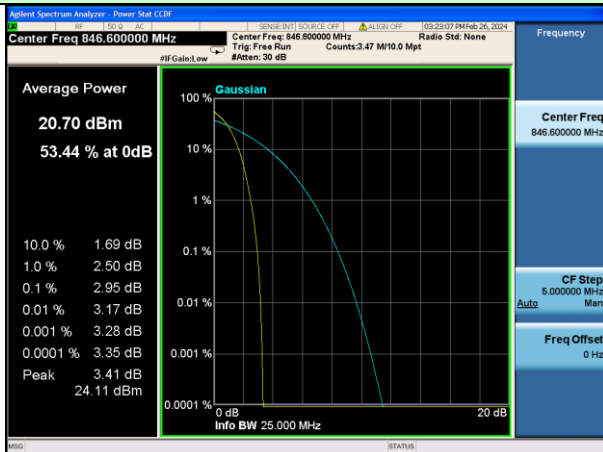

4.5 Occupy Bandwidth

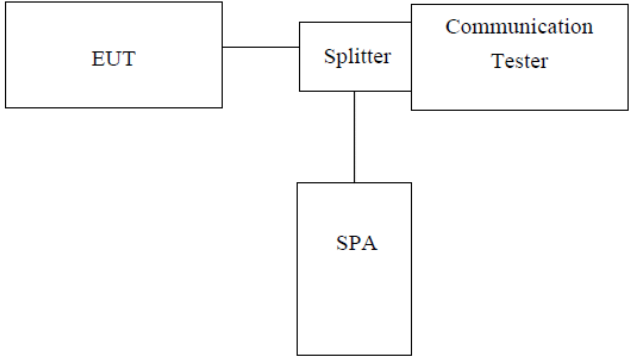
Test Requirement:	FCC part22.913(a) and FCC part24.232(b), FCC part27.53(h),
Test Method:	FCC part2.1049
Test setup:	 <pre> graph LR EUT[EUT] --- Splitter[Splitter] Splitter --- CT[Communication Tester] Splitter --- SPA[SPA] </pre> <p><i>Note: Measurement setup for testing on Antenna connector</i></p>
Test Procedure:	<ol style="list-style-type: none"> 1. The EUT's output RF connector was connected with a short cable to the spectrum analyzer 2. RBW was set to about 1% of emission BW, VBW= 3 times RBW. 3. -26dBc display line was placed on the screen (or 99% bandwidth), the occupied bandwidth is the delta frequency between the two points where the display line intersects the signal trace.
Test Instruments:	Refer to section 5.0 for details
Test mode:	Refer to section 6.1 for details
Test results:	Pass

Measurement Data

EUT Mode	Channel	Frequency (MHz)	99% Occupy bandwidth (KHz)	-26dB bandwidth (KHz)
GSM 850 (GSM link)	128	824.20	246.80	314.3
	190	836.60	245.37	313.8
	251	848.80	246.07	322.0
GSM 850 (GPRS 1 link)	128	824.20	241.53	308.6
	190	836.60	239.51	313.6
	251	848.80	237.50	316.3
GSM 850 (EGPRS 1 link)	128	824.20	237.43	314.4
	190	836.60	237.00	307.1
	251	848.80	234.15	322.9
PCS 1900 (GSM link)	512	1850.20	246.80	316.2
	661	1880.00	251.60	319.1
	810	1909.80	245.73	312.9
PCS 1900 (GPRS 1 link)	512	1850.20	244.53	326.8
	661	1880.00	242.21	313.8
	810	1909.80	239.81	318.5
PCS 1900 (EGPRS 1 link)	512	1850.20	241.43	319.9
	661	1880.00	235.29	308.3
	810	1909.80	236.61	315.4
WCDMA Band V (RMC 12.2Kbps link)	4132	826.40	4156.7	4730
	4183	836.60	4167.5	4714
	4233	846.60	4161.2	4724
WCDMA Band II (RMC 12.2Kbps link)	9262	1852.4	4158.7	4711
	9400	1880.0	4152.5	4706
	9538	1907.6	4177.6	4715
WCDMA Band IV (RMC 12.2Kbps link)	1312	1712.4	4161.3	4700
	1450	1740.0	4169.2	4696
	1513	1752.6	4166.1	4719

Test plot as follows:

GSM 850 (GSM link)	GSM 850 (GPRS 1 link)
--------------------	-----------------------

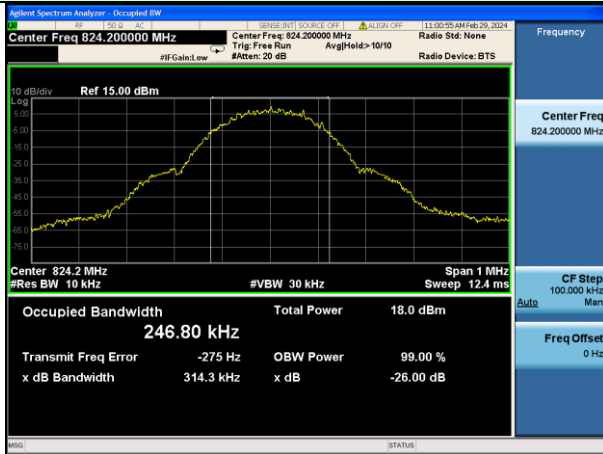

Lowest channel

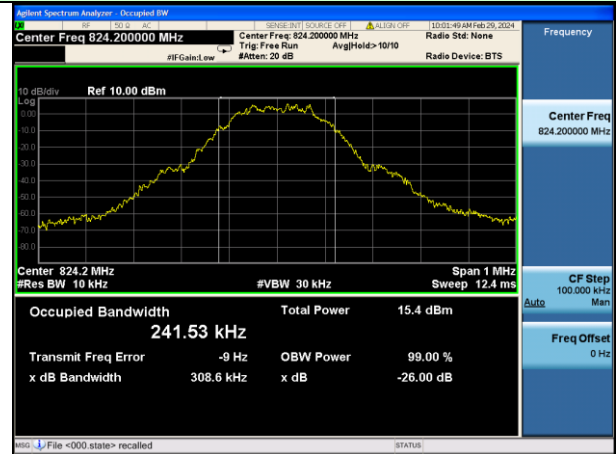

Lowest channel

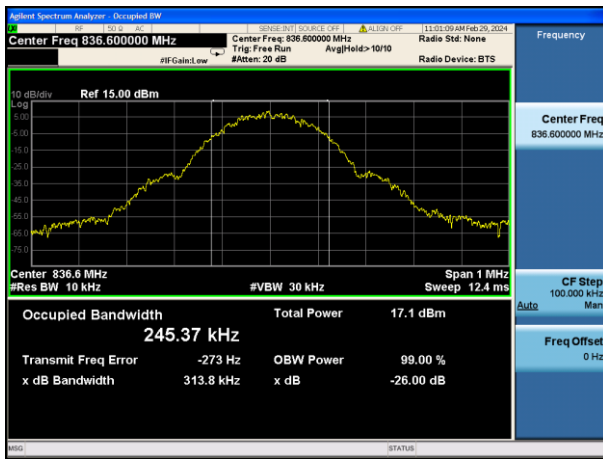

Middle channel

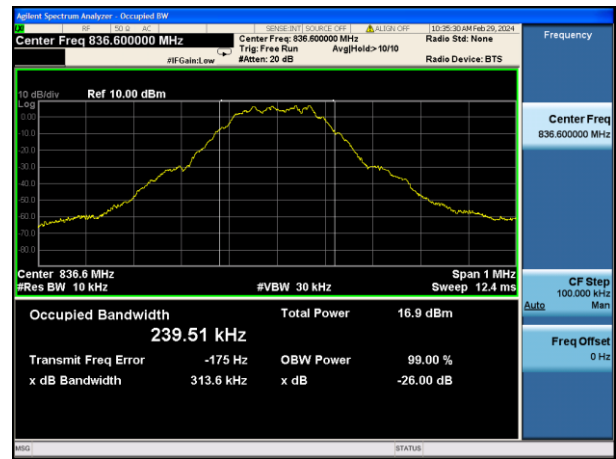

Middle channel

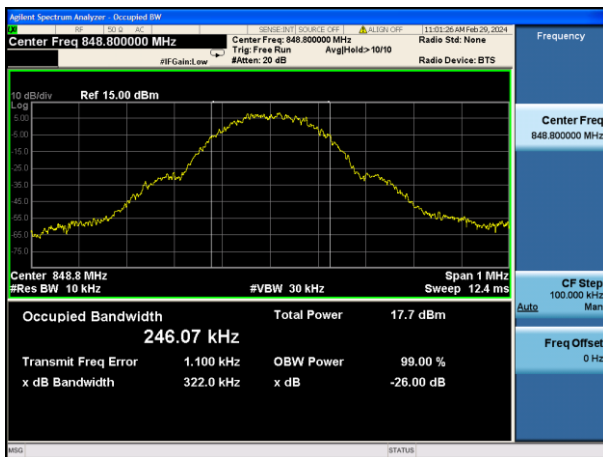

Highest channel

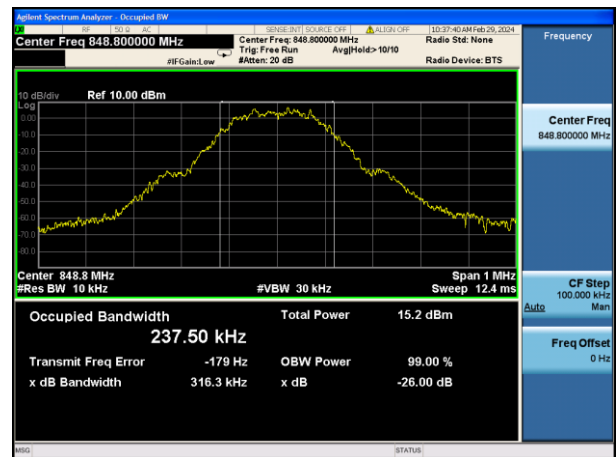

Highest channel

GSM 850 (EGPRS 1 link)	PCS 1900 (GSM link)
------------------------	---------------------

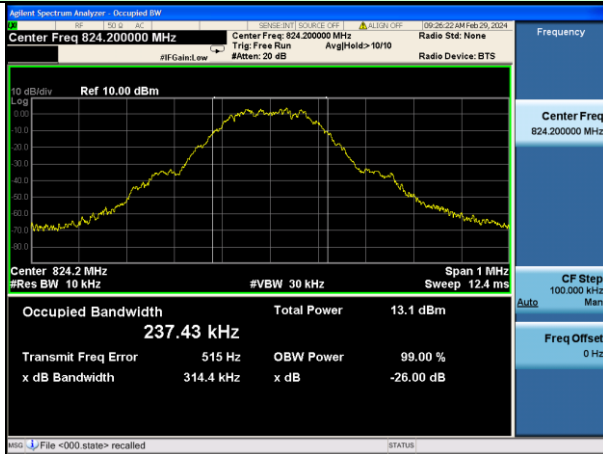

Lowest channel

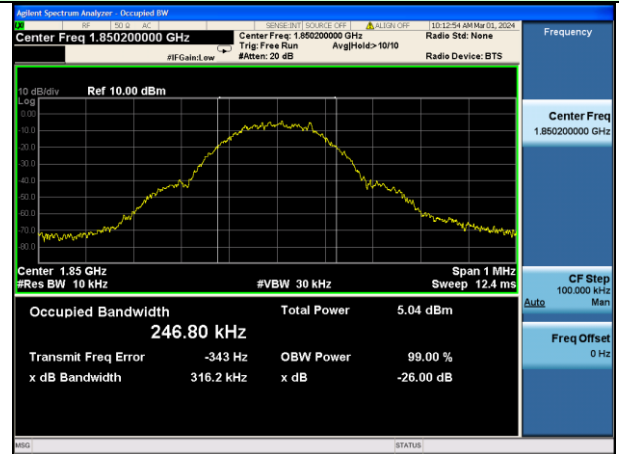

Lowest channel

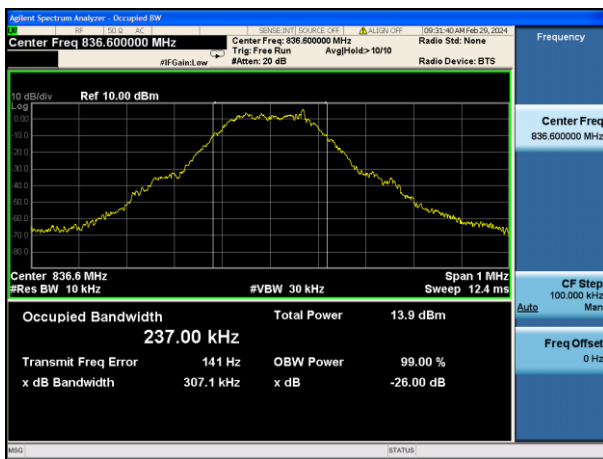

Middle channel

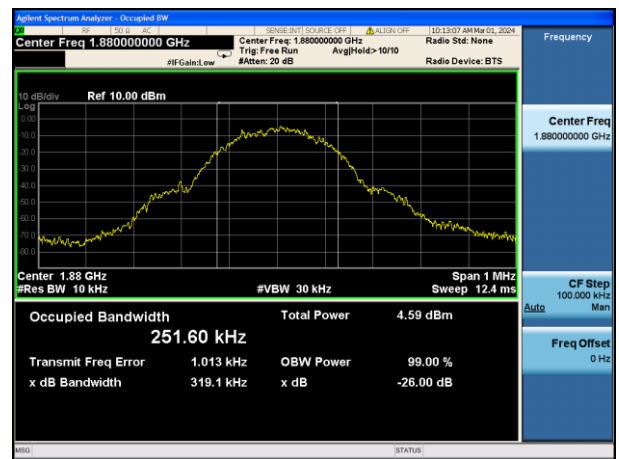

Middle channel

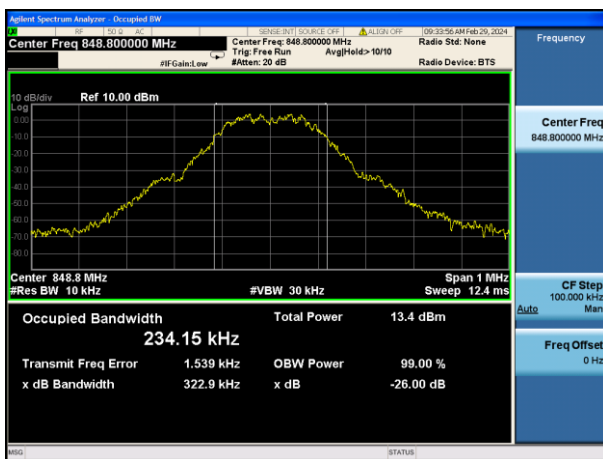

Highest channel

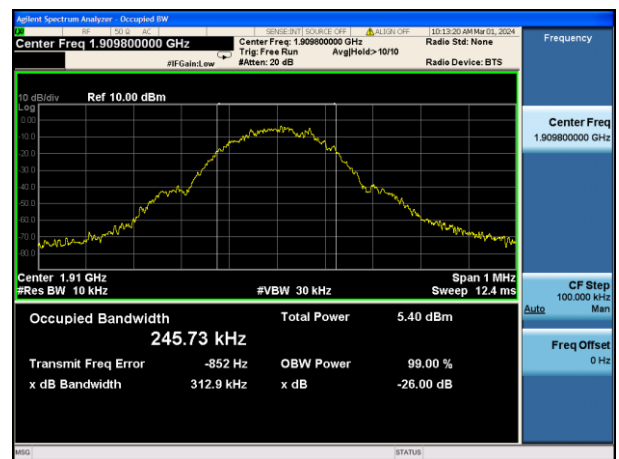

Highest channel

PCS 1900 (GPRS 1 link) PCS 1900 (EGPRS 1 link)

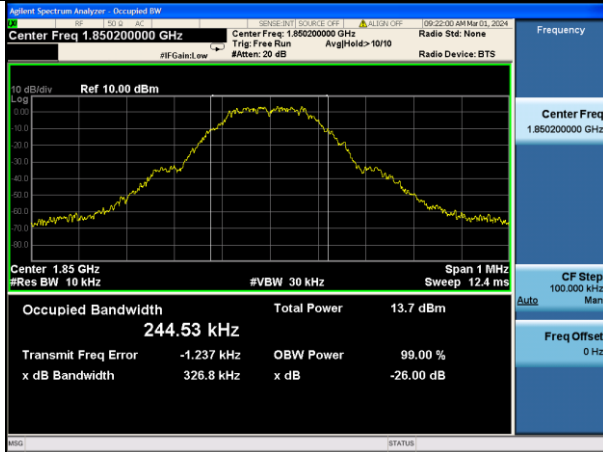

Lowest channel

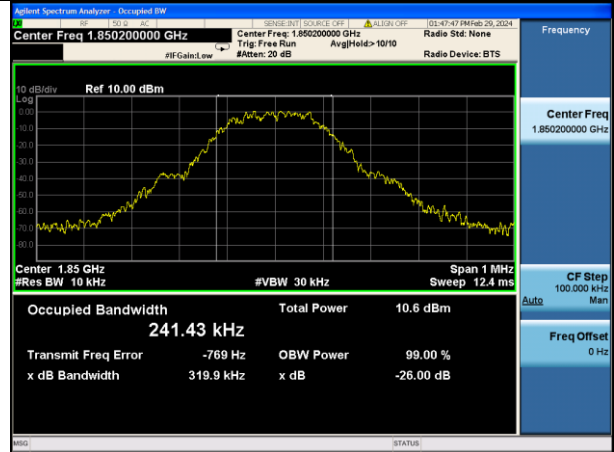

Lowest channel

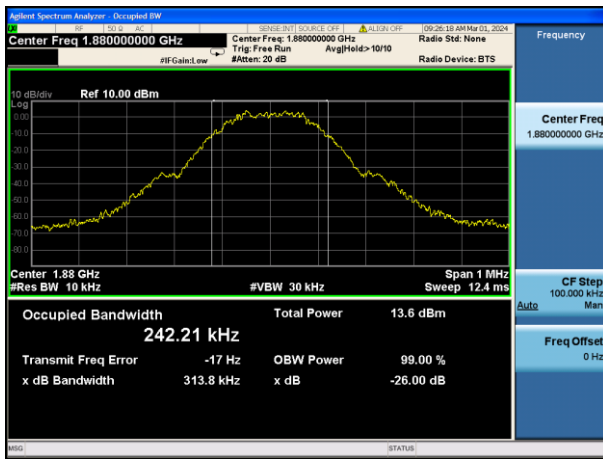

Middle channel

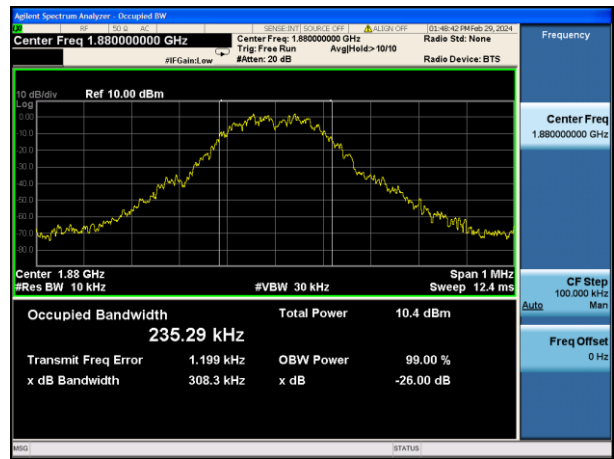

Middle channel

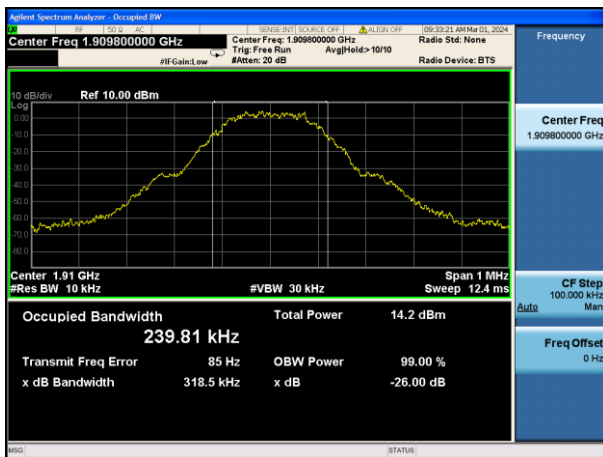

Highest channel

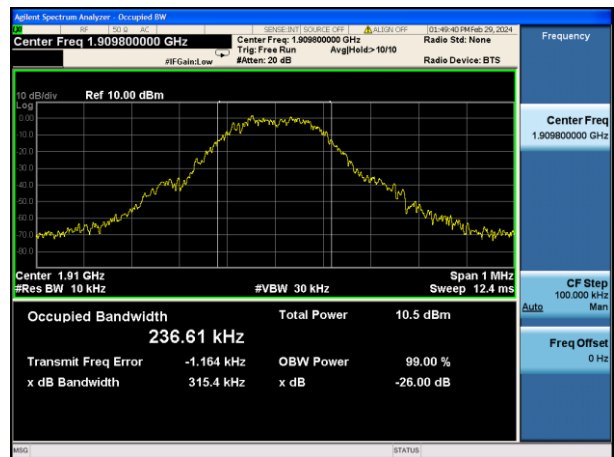

Highest channel

WCDMA Band V (RMC 12.2Kbps link) | WCDMA Band II (RMC 12.2Kbps link)

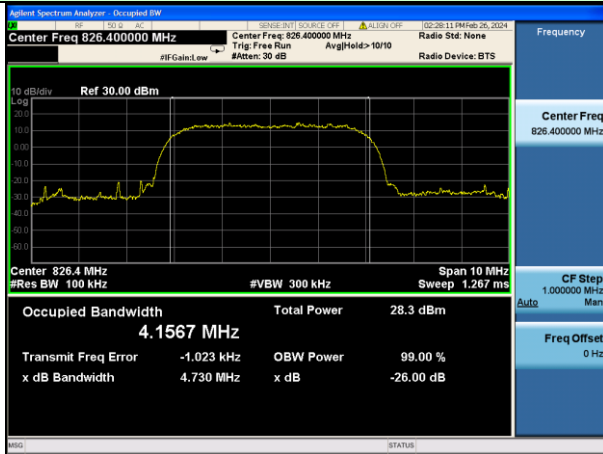

Lowest channel

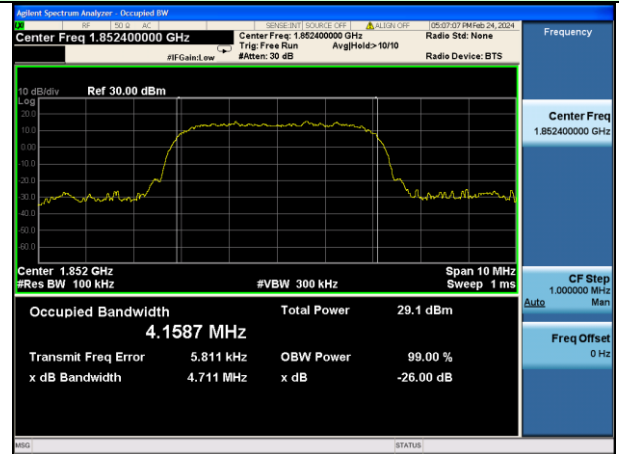

Lowest channel

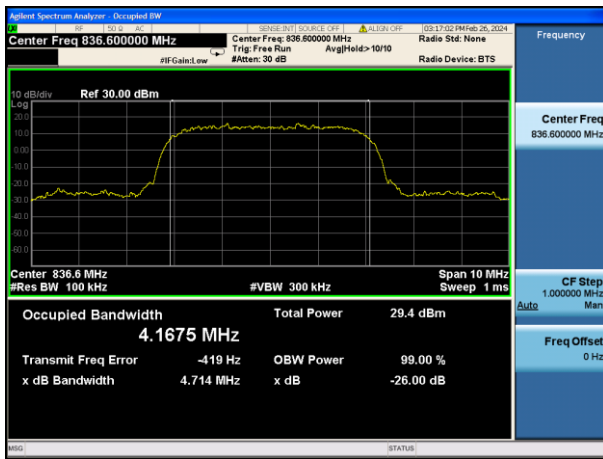

Middle channel

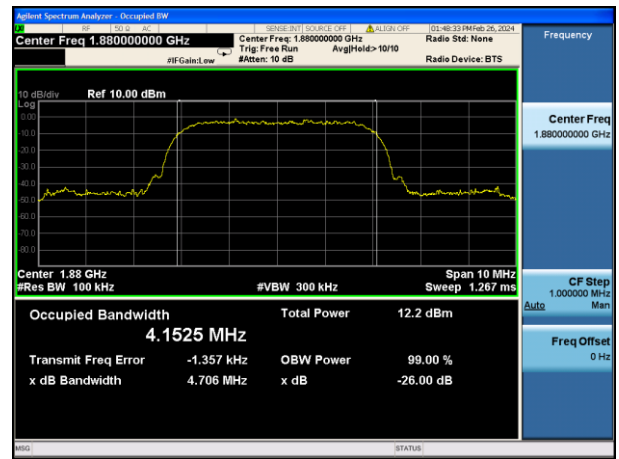

Middle channel

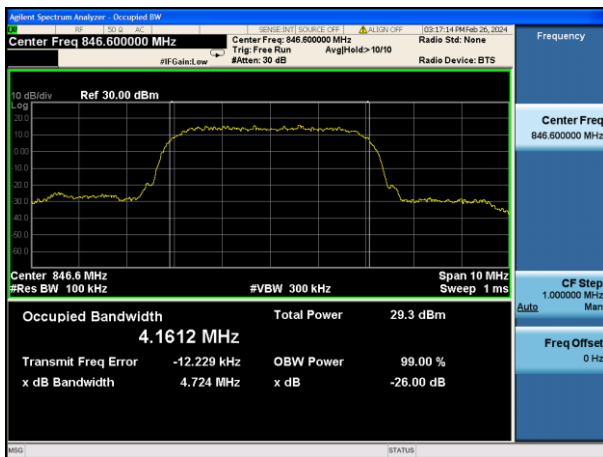

Highest channel

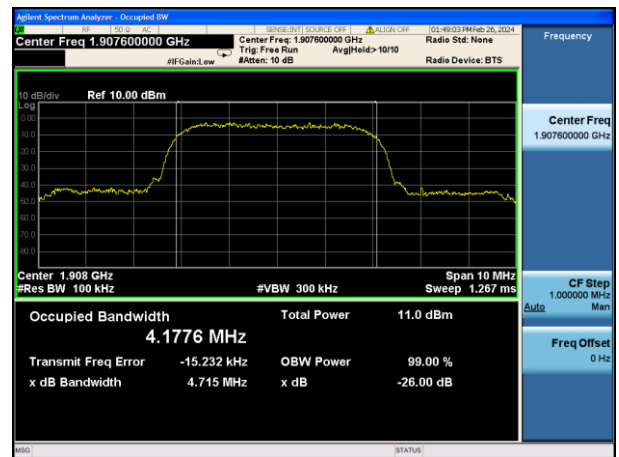

Highest channel

WCDMA Band IV (RMC 12.2Kbps link)

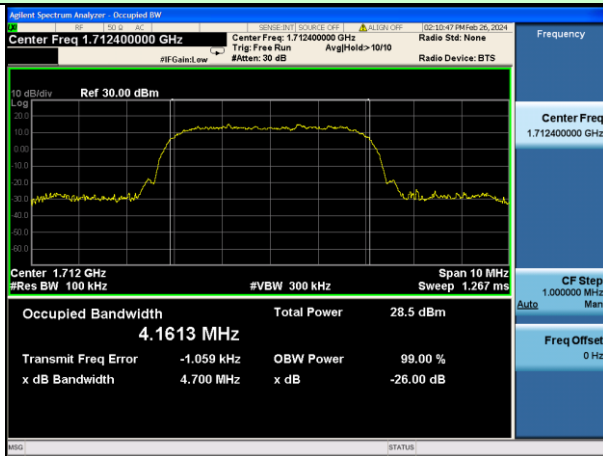

Lowest channel

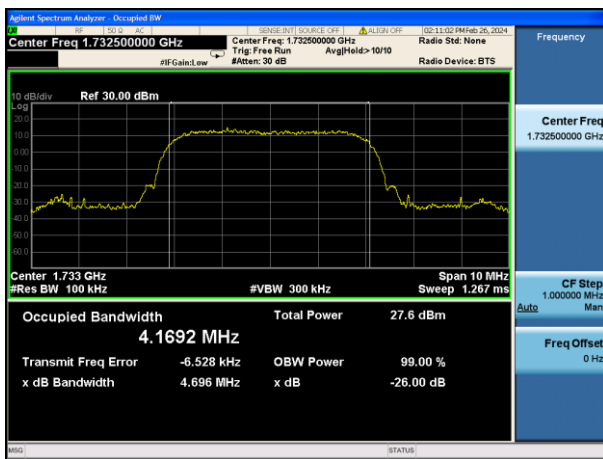

Middle channel

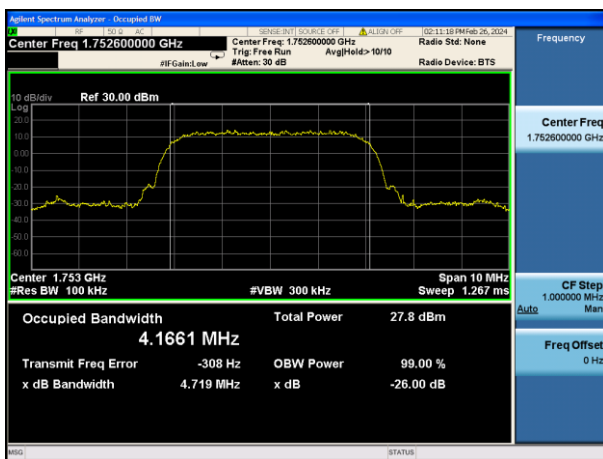

Highest channel

4.6 MODULATION CHARACTERISTIC

According to FCC § 2.1047(d), Part 22H & 24E & 27C, there is no specific requirement for digital modulation, therefore modulation characteristic is not presented.

4.7 Out of band emission at antenna terminals

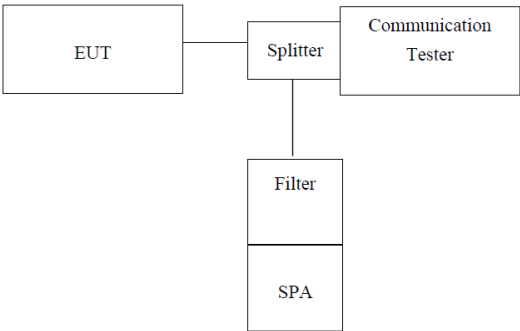
Test Requirement:	FCC part22.917(a) and FCC part24.238(a), FCC part27.53(h)
Test Method:	FCC part2.1051
Limit:	-13dBm
Test setup:	 <p><i>Note: Measurement setup for testing on Antenna connector</i></p>
Test Procedure:	<ol style="list-style-type: none"> 1 The RF output of the transceiver was connected to a spectrum analyzer through appropriate attenuation. 2 The resolution bandwidth of the spectrum analyzer was set at 1MHz, sufficient scans were taken to show the out of band Emissions if any up to 10th harmonic. 3 For the out of band: Set the RBW, VBW = 1MHz, Start=30MHz, Stop= 10th harmonic. 4 Band Edge Requirements: In the 1 MHz bands immediately outside and adjacent to the frequency block, a resolution bandwidth of at least 1 percent of the emission bandwidth of the fundamental emission of the transmitter may be employed to measure the out of band Emissions.
Test Instruments:	Refer to section 5.0 for details
Test mode:	Refer to section 6.1 for details
Test results:	Pass

Test plot as follows:

Note: During the conducted spurious emission test, a band filter was used. The information of the filter is reported at section 6.0 (refer to item 24, 25).

Test Mode: Traffic mode GSM 850 (GSM link)

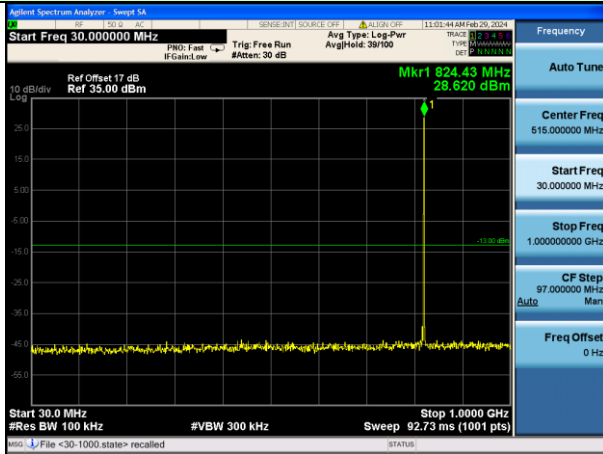

Lowest channel

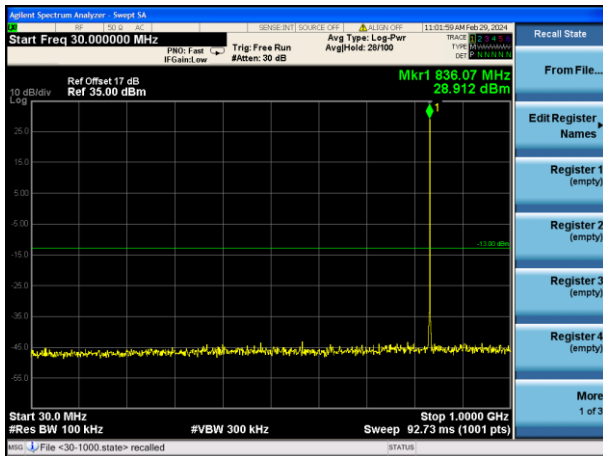

Middle channel

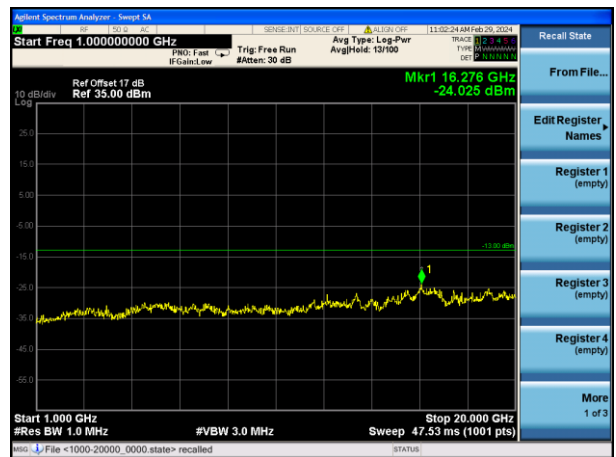
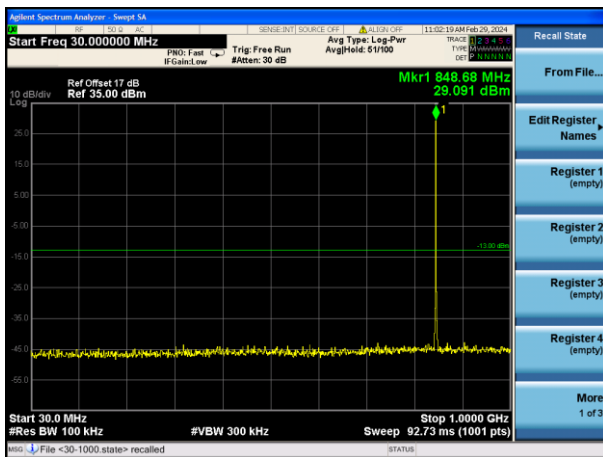

Highest channel

Test Mode: Traffic mode GSM 850 (GPRS 1 link)

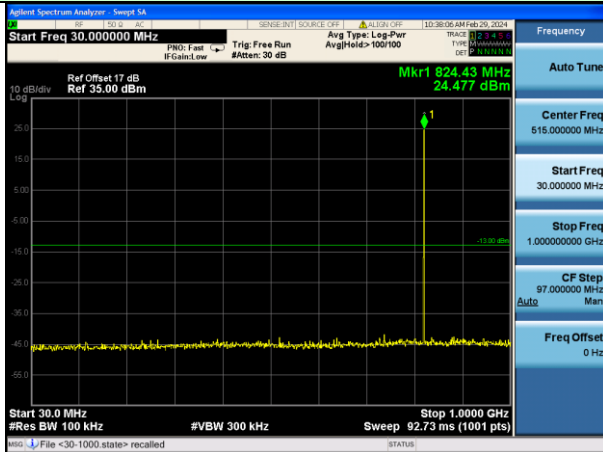

Lowest channel

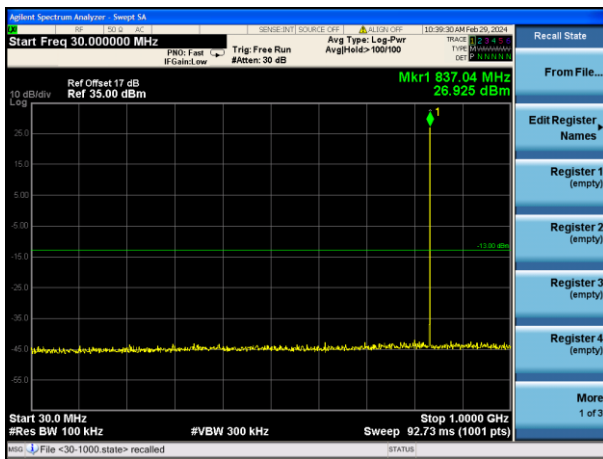

Middle channel

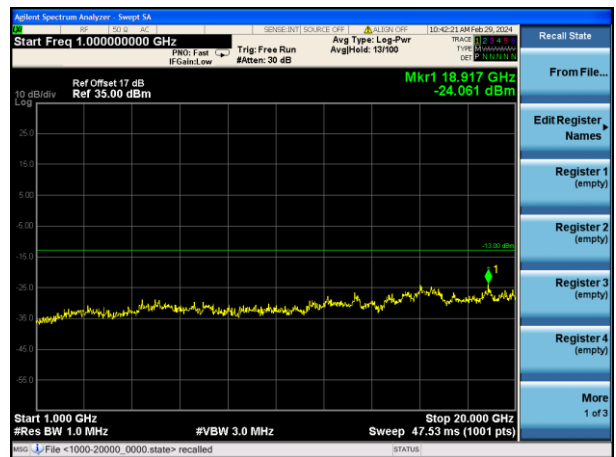
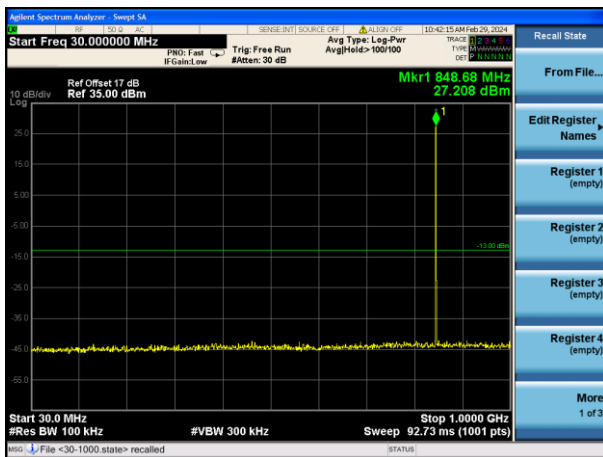

Highest channel

Test Mode: Traffic mode GSM 850 (EGPRS 1 link)

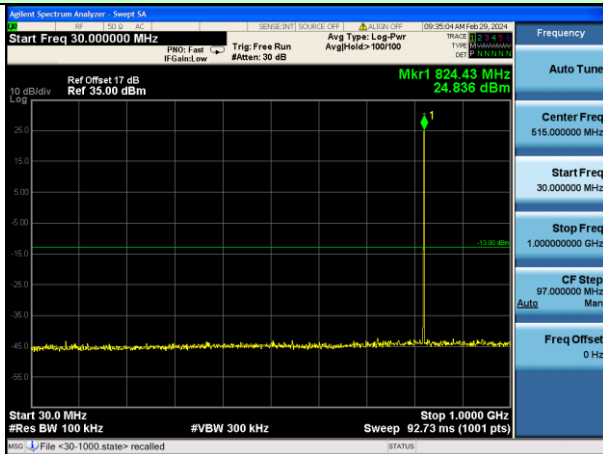

Lowest channel

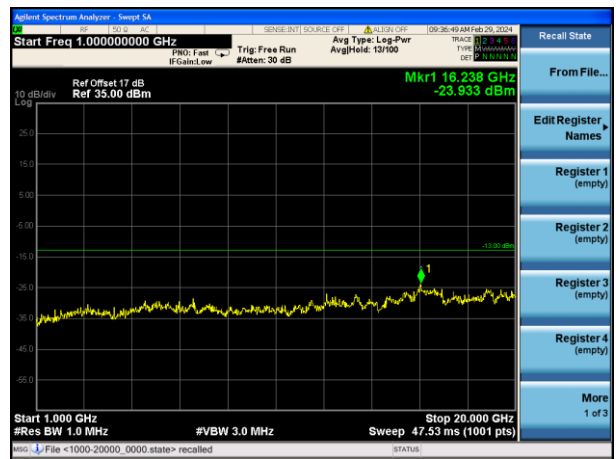
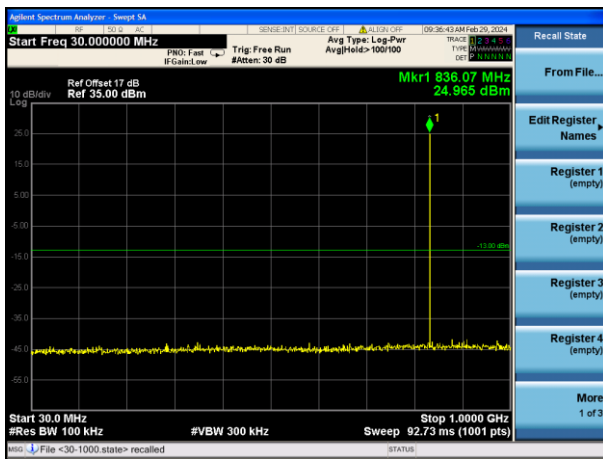

Middle channel

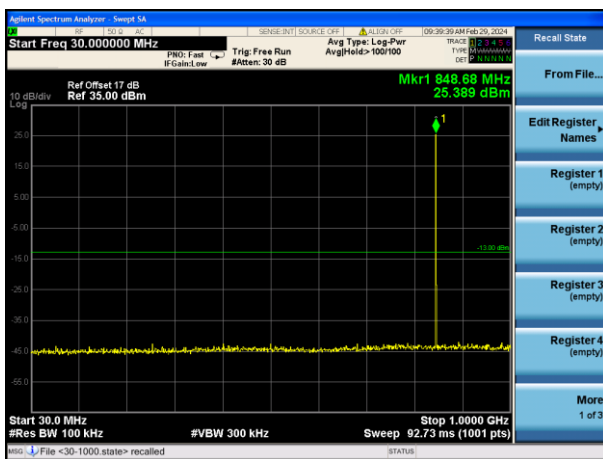

Highest channel

Test Mode: Traffic mode PCS1900 (GSM link)

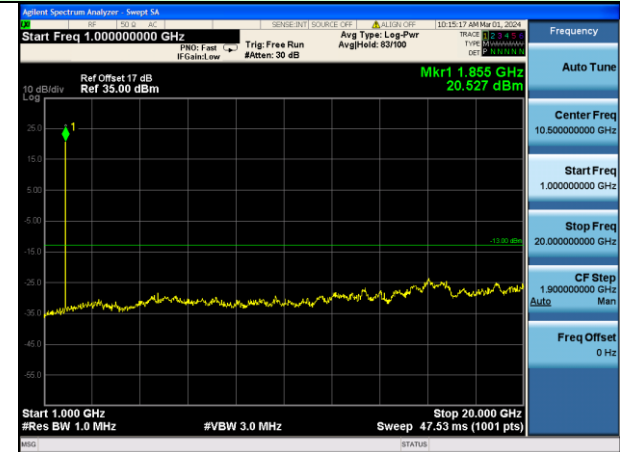
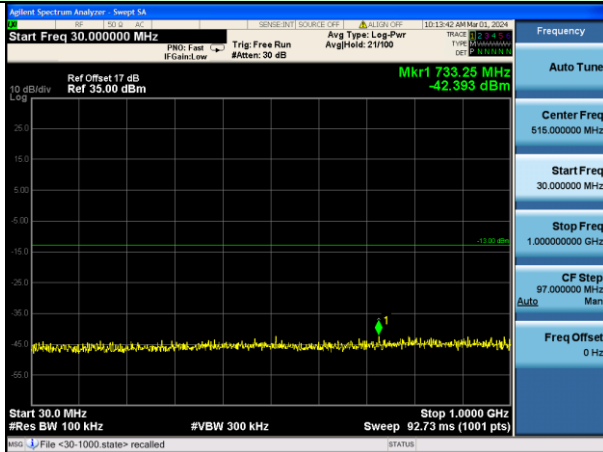

Lowest channel

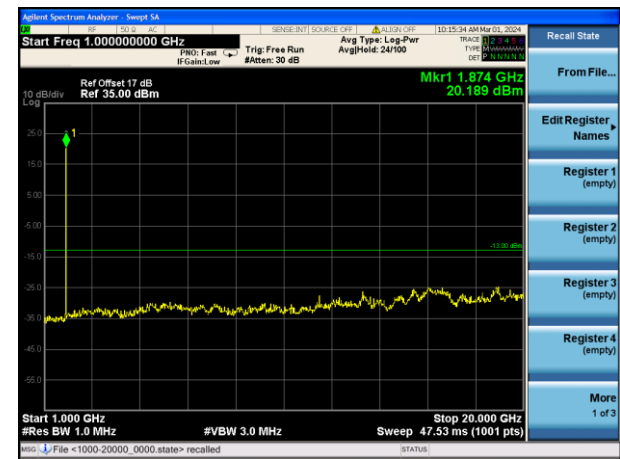
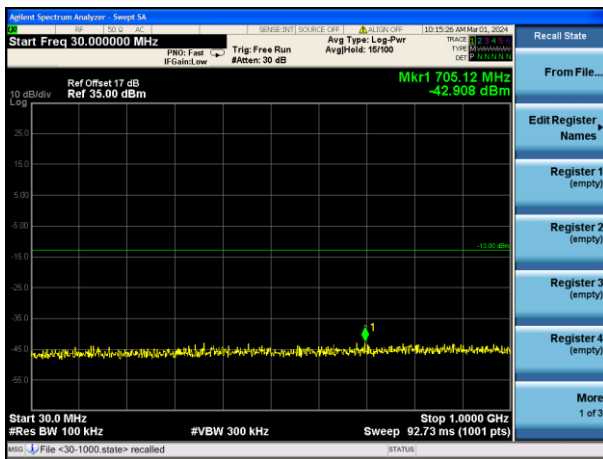

Middle channel

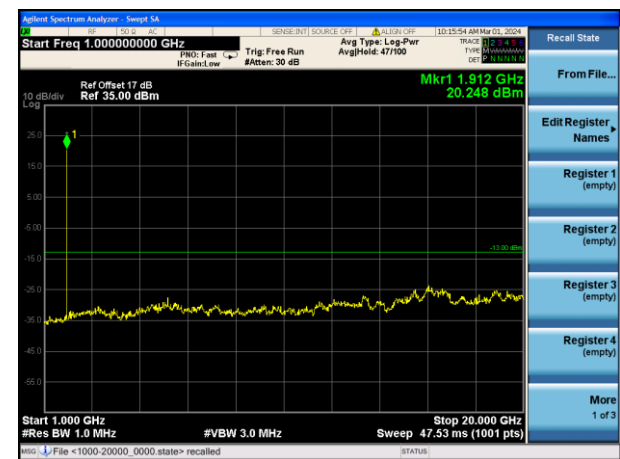
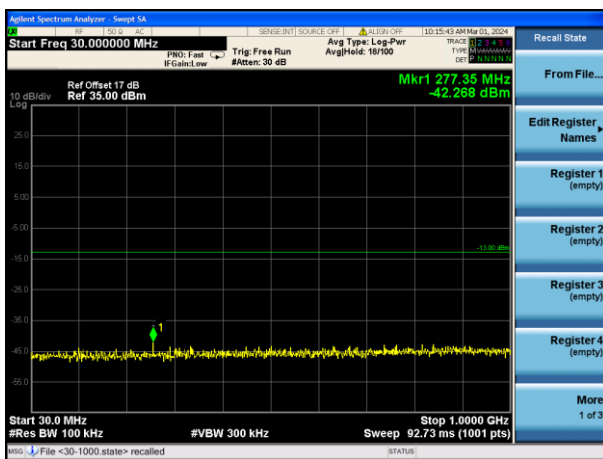

Highest channel