

FCC PART 15 SUBPART C TEST REPORT

FCC PART 15 SUBPART E 15.407

Report Reference No......: **MTEB22120172-R2**

FCC ID.....: **2A3IW-R2-4KPRO**

Compiled by

(position+printed name+signature)..: File administrators Alisa Luo

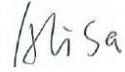

Supervised by

(position+printed name+signature)..: Test Engineer Sunny Deng



Approved by

(position+printed name+signature)..: Manager Yvette Zhou



Date of issue.....: January 09,2023

Representative Laboratory Name ..: **Shenzhen Most Technology Service Co., Ltd.**

Address.....: No.5, 2nd Langshan Road, North District, Hi-tech Industrial Park,
Nanshan, Shenzhen, Guangdong, China.

Applicant's name.....: **Aarna Sales Corporation**

Address.....: 1940 N Municipal Way, UNIT 2020, Round Lake, IL 60073

Test specification.....:

Standard.....: **FCC Part 15 Subpart E 15.407**

Shenzhen Most Technology Service Co., Ltd. All rights reserved.

This publication may be reproduced in whole or in part for non-commercial purposes as long as the Shenzhen Most Technology Service Co., Ltd. is acknowledged as copyright owner and source of the material. Shenzhen Most Technology Service Co., Ltd. takes no responsibility for and will not assume liability for damages resulting from the reader's interpretation of the reproduced material due to its placement and context.

Test item description.....: Car Dash Camera

Trade Mark.....: ROVE

Manufacturer.....: **Shenzhen Samoon Technology Co.,Ltd**

Model/Type reference.....: R2-4K PRO

Listed Models.....: N/A

Ratings.....: DC 5.5V(by Super Capacitor)

DC 5V (by Car charger)

Modulation.....: OFDM

Frequency.....: From 5180MHz-5240MHz

Hardware version.....: CHF43-MAN-A1 2020-08-011

Software version.....: V1

Result.....: **PASS**

TEST REPORT

Equipment under Test : Car Dash Camera

Model /Type : R2-4K PRO

Listed Models : N/A

Remark : N/A

Applicant : **Aarna Sales Corporation**

Address : 1940 N Municipal Way, UNIT 2020, Round Lake, IL 60073

Manufacturer : **Shenzhen Samoon Technology Co.,Ltd**

Address : Floor 6, Building 7, Zhongyuntai Science and Technology Industrial
Factory, Songbai Road, Shiyuan Street, Baoan District, Shenzhen
China

Test Result:	PASS
---------------------	-------------

The test report merely corresponds to the test sample.
It is not permitted to copy extracts of these test result without the written permission of the test laboratory.

Contents

<u>1 REVISION HISTORY</u>	<u>4</u>
<u>2 TEST STANDARDS</u>	<u>5</u>
<u>3 SUMMARY</u>	<u>6</u>
3.1 General Remarks	6
3.2 Product Description	6
3.3 Equipment Under Test	6
3.4 Short description of the Equipment under Test (EUT)	6
3.5 EUT operation mode	7
3.6 Block Diagram of Test Setup	7
3.1 Test Item (Equipment Under Test) Description*	7
3.2 Auxiliary Equipment (AE) Description	7
3.3 Related Submittal(s) / Grant (s)	8
3.4 Modifications	8
<u>4 TEST ENVIRONMENT</u>	<u>9</u>
4.1 Address of the test laboratory	9
4.2 Test Facility	9
4.3 Environmental conditions	9
4.4 Test Description	10
4.5 Statement of the measurement uncertainty	10
4.6 Equipments Used during the Test	11
<u>5 TEST CONDITIONS AND RESULTS</u>	<u>12</u>
5.1 AC Power Conducted Emission	12
5.2 Radiated Emissions	15
5.3 Maximum Conducted Average Output Power	29
5.4 Power Spectral Density	31
5.5 Emission Bandwidth (26dBm Bandwidth)	36
5.6 Minimum Emission Bandwidth (6dBm Bandwidth)	40
5.7 Frequency Stability	41
<u>6 TEST SETUP PHOTOS OF THE EUT</u>	<u>45</u>
<u>7 PHOTOS OF THE EUT</u>	<u>46</u>

1 Revision History

Revision	Issue Date	Revisions	Revised By
00	2023.01.09	Initial Issue	Alisa Luo

2 TEST STANDARDS

The tests were performed according to following standards:

[FCC Rules Part 15 Subpart E](#)—Unlicensed National Information Infrastructure Devices
[ANSI C63.10-2013](#): American National Standard for Testing Unlicensed Wireless Devices
[KDB789033 D02](#): General UNII Test Procedures New Rules v01r02

3 SUMMARY

3.1 General Remarks

Date of receipt of test sample	:	2022.12.15
Testing commenced on	:	2022.12.16
Testing concluded on	:	2023.01.09

3.2 Product Description

Product Description:	Car Dash Camera			
Model:	R2-4K PRO			
Power supply:	DC 5.5V(by Super Capacitor) DC 5V (by Car charger)			
Testing sample ID:	MT22120116			
WIFI				
	20MHz system	40MHz system	80MHz system	160MHz system
Supported type:	802.11a 802.11n 802.11ac	802.11n 802.11ac	802.11ac	N/A
Operation frequency:	5180MHz-5240MHz	5190MHz-5230MHz	5210MHz	N/A
Modulation:	OFDM	OFDM	OFDM	N/A
Channel number:	4	2	1	N/A
Antenna type:	FPC Antenna			
Antenna gain:	5180MHz-5240MHz:3.8dBi			

3.3 Equipment Under Test

Power supply system utilised

Power supply voltage	:	<input type="radio"/> 230V / 50 Hz	<input type="radio"/> 120V / 60Hz
		<input type="radio"/> 12 V DC	<input type="radio"/> 24 V DC
		<input checked="" type="radio"/> Other (specified in blank below)	

DC 5.5V(by Super Capacitor)

DC 5V (by Car charger)

3.4 Short description of the Equipment under Test (EUT)

This is a Car Dash Camera

For more details, refer to the user's manual of the EUT.

3.5 EUT operation mode

The Applicant provides communication tools software (AT command) to control the EUT for staying in continuous transmitting (Duty Cycle more than 98%) and receiving mode for testing. All test performed at the low, middle and high of operational frequency range of each mode.

Operation Frequency List WIFI on 5G Band:

Operating band	20MHz		40MHz		80MHz	
	Channel	Frequency (MHz)	Channel	Frequency (MHz)	Channel	Frequency (MHz)
U-NII 1 (5150MHz-5250MHz)	36	5180	38	5190	42	5210
	40	5200				
	44	5220				
	48	5240				

Note: The line display in grey is those Channels/Frequencies select to test in this report for each operation mode.

3.6 Block Diagram of Test Setup

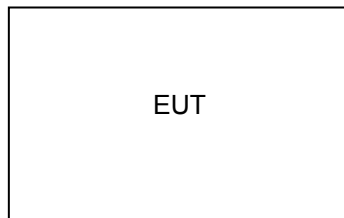

3.1 Test Item (Equipment Under Test) Description*

Short designation	EUT Name	EUT Description	Serial number	Hardware status	Software status
EUT A					
EUT B					

*: declared by the applicant. According to customers information EUTs A and B are the same devices.

3.2 Auxiliary Equipment (AE) Description

AE short designation	EUT Name (if available)	EUT Description	Serial number (if available)	Software (if used)
AE 1	-			
AE 2	-			

3.3 Antenna Information*

Short designation	Antenna Name	Antenna Type	Frequency Range	Serial number	Antenna Peak Gain
Antenna 1	---	Ceramic Antenna	5180MHz-5240MHz	---	3.8dBi
Antenna 2					

*: declared by the applicant.

3.4 Related Submittal(s) / Grant (s)

This submittal(s) (test report) is intended to comply with Section 15.407 of the FCC Part 15, Subpart E Rules.

3.5 Modifications

No modifications were implemented to meet testing criteria.

4 TEST ENVIRONMENT

4.1 Address of the test laboratory

Shenzhen Most Technology Service Co., Ltd.
No.5, 2nd Langshan Road, North District, Hi-tech Industrial Park, Nanshan, Shenzhen, Guangdong, China.

The 3m-Semi anechoic test site fulfils CISPR 16-1-4 according to ANSI C63.4:2014 and CISPR 16-1-4:2010 SVSWR requirement for radiated emission above 1GHz.

4.2 Test Facility

The test facility is recognized, certified, or accredited by the following organizations:

The test facility is recognized, certified, or accredited by the following organizations:

FCC-Registration No.: 0031192610

Shenzhen Most Technology Service Co., Ltd. EMC Laboratory has been registered and fully described in a report filed with the (FCC) Federal Communications Commission. The acceptance letter from the FCC is maintained in our files.

A2LA-Lab Cert. No.: 6343.01

Shenzhen Most Technology Service Co., Ltd. EMC Laboratory has been accredited by A2LA for technical competence in the field of electrical testing, and proved to be in compliance with ISO/IEC 17025: 2005 General Requirements for the Competence of Testing and Calibration Laboratories and any additional program requirements in the identified field of testing.

4.3 Environmental conditions

Radiated Emission:

Temperature:	23 ° C
Humidity:	48 %
Atmospheric pressure:	950-1050mbar

AC Main Conducted testing:

Temperature:	24 ° C
Humidity:	45 %
Atmospheric pressure:	950-1050mbar

Conducted testing:

Temperature:	24 ° C
Humidity:	45 %
Atmospheric pressure:	950-1050mbar

4.4 Test Description

FCC Requirement		
FCC Part 15.207	AC Power Conducted Emission	PASS
FCC Part 15.407(a)	Emission Bandwidth(26dBm Bandwidth)	PASS ^{Note1}
FCC Part 15.407(e)	Minimum Emission Bandwidth(6dBm Bandwidth)	N/A ^{Note2}
FCC Part 15.407(a)	Maximum Conducted Output Power	PASS
FCC Part 15.407(a)	Peak Power Spectral Density	PASS
FCC Part 15.407(g)	Frequency Stability	PASS
FCC Part 15.407(b)	Undesirable emission	PASS
FCC Part 15.407(b)/15.205/15.209	Radiated Emissions	PASS
FCC Part 15.407(h)	Dynamic Frequency Selection	N/A ^{Note 3}
FCC Part 15.203/15.247(b)	Antenna Requirement	PASS

Note 1: Apply to U-NII 1, U-NII 2A, and U-NII 2C band.

Note 2: Apply to U-NII 3 band only.

Note 3: This device not work in DFS band.

Data Rate Used:

Preliminary tests were performed in different data rate to find the worst radiated emission. The data rate shown in the table below is the worst-case rate with respect to the specific test item. Investigation has been done on all the possible configurations for searching the worst cases. The following table is a list of the test modes shown in this test report.

Test Items	Mode	Data Rate
Maximum Conducted Output Power Power Spectral Density Emission Bandwidth(26dBm Bandwidth) Minimum Emission Bandwidth(6dBm Bandwidth) Undesirable emission Frequency Stability	11a/OFDM	6 Mbps
	11n(20MHz),11ac(20MHz)/OFDM	7.2 Mbps
	11n(40MHz),11ac(40MHz)/OFDM	15.0Mbps
	11ac(80MHz)/OFDM	65.0Mbps

4.5 Statement of the measurement uncertainty

The data and results referenced in this document are true and accurate. The reader is cautioned that there may be errors within the calibration limits of the equipment and facilities. The measurement uncertainty was calculated for all measurements listed in this test report acc. to CISPR 16 - 4 „Specification for radio disturbance and immunity measuring apparatus and methods – Part 4: Uncertainty in EMC Measurements— and is documented in the Shenzhen Most Technology Service Co., Ltd. quality system acc. to DIN EN ISO/IEC 17025. Furthermore, component and process variability of devices similar to that tested may result in additional deviation. The manufacturer has the sole responsibility of continued compliance of the device.

Hereafter the best measurement capability for Shenzhen Most Technology Service Co., Ltd. is reported:

Test	Range	Measurement Uncertainty	Notes
Radiated Emission	30~1000MHz	4.10 Db	(1)
Radiated Emission	1~18GHz	4.32 Db	(1)
Radiated Emission	18-40GHz	5.54 dB	(1)
Conducted Disturbance	0.15~30MHz	3.12 dB	(1)

(1) This uncertainty represents an expanded uncertainty expressed at approximately the 95% confidence level using a coverage factor of k=2.

4.6 Equipments Used during the Test

5

Item	Equipment	Manufacturer	Model No.	Serial No.	Firmware versions	Last Cal.	Cal. Interval
1.	L.I.S.N.	R&S	ENV216	100093	/	2022/04/19	1 Year
2	Three-phase artificial power network	Schwarzback Mess	NNLK8129	8129178	/	2022/04/19	1 Year
3.	Receiver	R&S	ESCI	100492	V3.0-10-2	2022/04/19	1 Year
4	Receiver	R&S	ESPI	101202	V3.0-10-2	2022/04/19	1 Year
5	Spectrum analyzer	Agilent	9020A	MT-E306	A14.16	2022/04/19	1 Year
6	Bilong Antenna	Sunol Sciences	JB3	A121206	/	2022/04/19	1 Year
7	Horn antenna	HF Antenna	HF Antenna	MT-E158	/	2022/04/19	1 Year
8	Loop antenna	Beijing Daze	ZN30900B	/	/	2022/04/19	1 Year
9	Horn antenna	R&S	OBH100400	26999002	/	2022/04/19	1 Year
10	Wireless Communication Test Set	R&S	CMW500	/	CMW-BASE-3.7.21	2022/04/19	1 Year
11	Spectrum analyzer	R&S	FSP	100019	V4.40 SP2	2022/04/19	1 Year
12	High gain antenna	Schwarzbeck	LB-180400KF	MT-E389	/	2022/04/19	1 Year
13	Preamplifier	Schwarzbeck	BBV 9743	MT-E390	/	2022/04/19	1 Year
14	Pre-amplifier	EMCI	EMC051845S E	MT-E391	/	2022/04/19	1 Year
15	Pre-amplifier	Agilent	83051A	MT-E392	/	2022/04/19	1 Year
16	High pass filter unit	Tonscend	JS0806-F	MT-E393	/	2022/04/19	1 Year
17	RF Cable(below1GHz)	Times	9kHz-1GHz	MT-E394	/	2022/04/19	1 Year
18	RF Cable(above 1GHz)	Times	1-40G	MT-E395	/	2022/04/19	1 Year
19	RF Cable (9KHz-40GHz)	Tonscend	170660	N/A	/	2022/04/19	1 Year

6 Note: The Cal.Interval was one year.

7 TEST CONDITIONS AND RESULTS

7.1 AC Power Conducted Emission

TEST CONFIGURATION

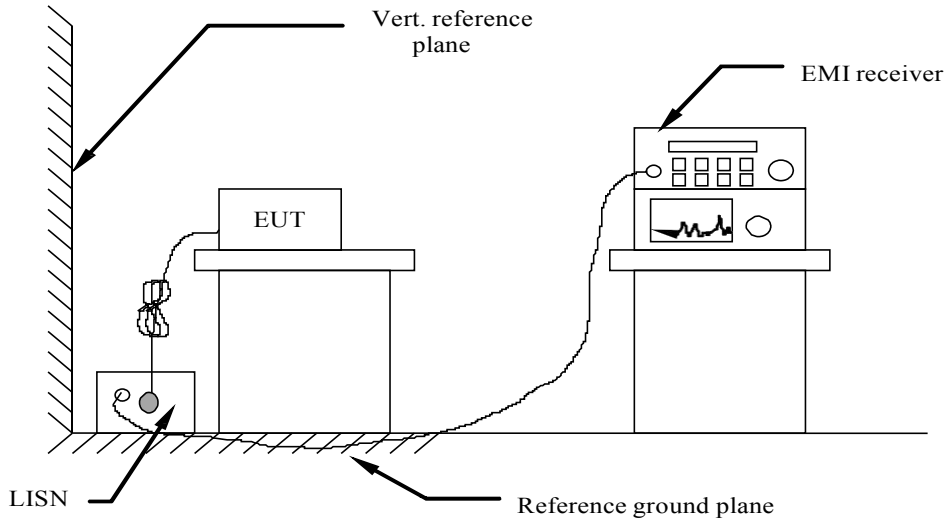

TEST PROCEDURE

- 1 The equipment was set up as per the test configuration to simulate typical actual usage per the user's manual. The EUT is a tabletop system, a wooden table with a height of 0.8 meters is used and is placed on the ground plane as per ANSI C63.10-2013.
- 2 Support equipment, if needed, was placed as per ANSI C63.10-2013
- 3 All I/O cables were positioned to simulate typical actual usage as per ANSI C63.10-2013
- 4 The EUT received DC 12V power from adapter, the adapter received AC120V/60Hz and AC 240V/60Hz power through a Line Impedance Stabilization Network (LISN) which supplied power source and was grounded to the ground plane.
- 5 All support equipments received AC power from a second LISN, if any.
- 6 The EUT test program was started. Emissions were measured on each current carrying line of the EUT using a spectrum Analyzer / Receiver connected to the LISN powering the EUT. The LISN has two monitoring points: Line 1 (Hot Side) and Line 2 (Neutral Side). Two scans were taken: one with Line 1 connected to Analyzer / Receiver and Line 2 connected to a 50 ohm load; the second scan had Line 1 connected to a 50 ohm load and Line 2 connected to the Analyzer / Receiver.
- 7 Analyzer / Receiver scanned from 150 KHz to 30MHz for emissions in each of the test modes.
- 8 During the above scans, the emissions were maximized by cable manipulation.

AC Power Conducted Emission Limit

For intentional device, according to § 15.207(a) AC Power Conducted Emission Limits is as following :

Frequency range (MHz)	Limit (dBuV)	
	Quasi-peak	Average
0.15-0.5	66 to 56*	56 to 46*
0.5-5	56	46
5-30	60	50

* Decreases with the logarithm of the frequency.

TEST RESULTS

Remark:

1. All modes were test at Low, Middle, and High channel; only the worst result of 802.11a Middle Channel was reported as below:

2. Remark: Result=Reading value+Factor,and Margin=Limit- Result

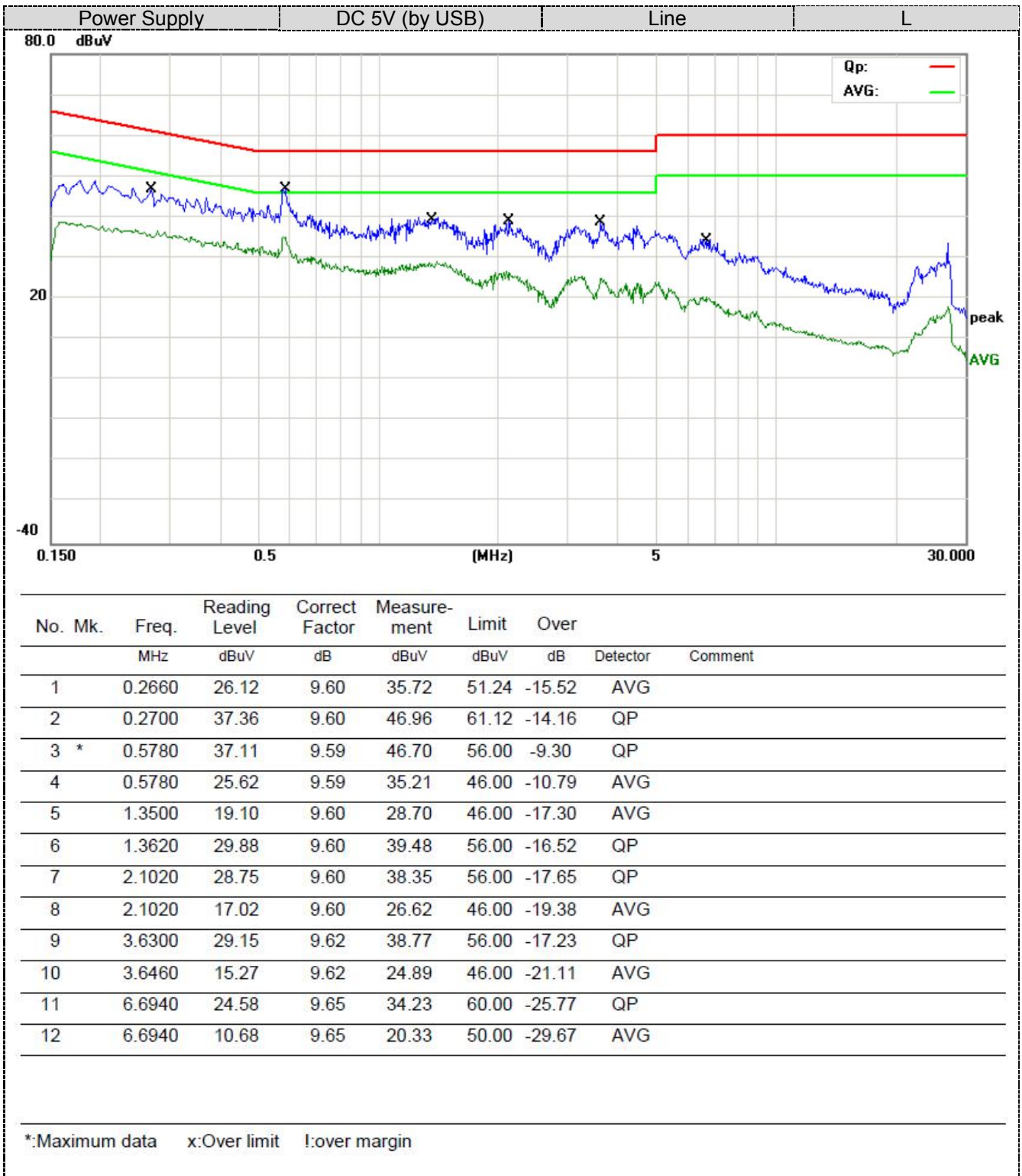

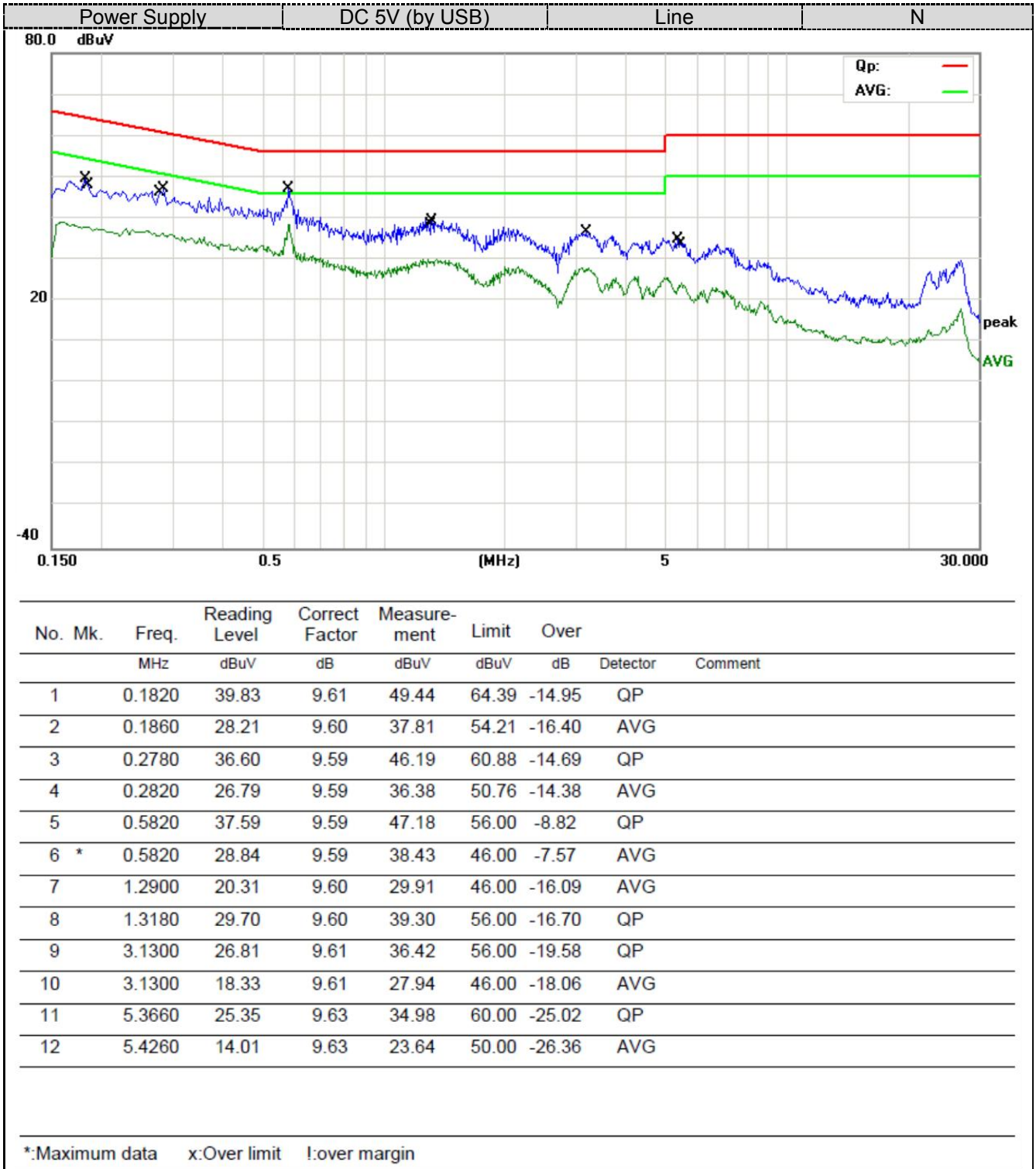

7.2 Radiated Emissions

Limit

The maximum emissions outside of the frequency bands of operation shall be attenuated in accordance with the following limits:

- (1) For transmitters operating in the 5.15-5.25 GHz band: All emissions outside of the 5.15-5.35 GHz band shall not exceed an e.i.r.p. of -27 dBm/MHz.
- (2) For transmitters operating in the 5.25-5.35 GHz band: All emissions outside of the 5.15-5.35 GHz band shall not exceed an e.i.r.p. of -27 dBm/MHz.
- (3) For transmitters operating in the 5.47-5.725 GHz band: All emissions outside of the 5.47-5.725 GHz band shall not exceed an e.i.r.p. of -27 dBm/MHz.
- (4) For transmitters operating in the 5.725-5.85 GHz band: All emissions shall be limited to a level of -27 dBm/MHz at 75 MHz or more above or below the band edge increasing linearly to 10 dBm/MHz at 25 MHz above or below the band edge, and from 25 MHz above or below the band edge increasing linearly to a level of 15.6 dBm/MHz at 5 MHz above or below the band edge, and from 5 MHz above or below the band edge increasing linearly to a level of 27 dBm/MHz at the band edge.

Undesirable emission limits

Requirement	Limit(EIRP)	Limit (Field strength at 3m) <small>Note1</small>
15.407(b)(1)	PK:-27(dBm/MHz)	PK:68.2(dBμV/m)
15.407(b)(2)		
15.407(b)(3)		
15.407(b)(4)		

Note1: The following formula is used to convert the equipment isotropic radiated power (eirp) to field strength:

$$E = \frac{1000000\sqrt{30P}}{3} \mu\text{V/m, where P is the eirp (Watts)}$$

- (5) Unwanted emissions below 1 GHz must comply with the general field strength limits set forth in §15.209
- (6) In addition, radiated emissions which fall in the restricted bands, as defined in §15.205(a), must also comply with the radiated emission limits specified in §15.209(a)

Radiated emission limits

Frequency (MHz)	Distance (Meters)	Radiated (dBμV/m)	Radiated (μV/m)
0.009-0.49	3	20log(2400/F(KHz))+40log(300/3)	2400/F(KHz)
0.49-1.705	3	20log(24000/F(KHz))+ 40log(30/3)	24000/F(KHz)
1.705-30	3	20log(30)+ 40log(30/3)	30
30-88	3	40.0	100
88-216	3	43.5	150
216-960	3	46.0	200
Above 960	3	54.0	500

TEST CONFIGURATION

(A) Radiated Emission Test Set-Up, Frequency Below 30MHz

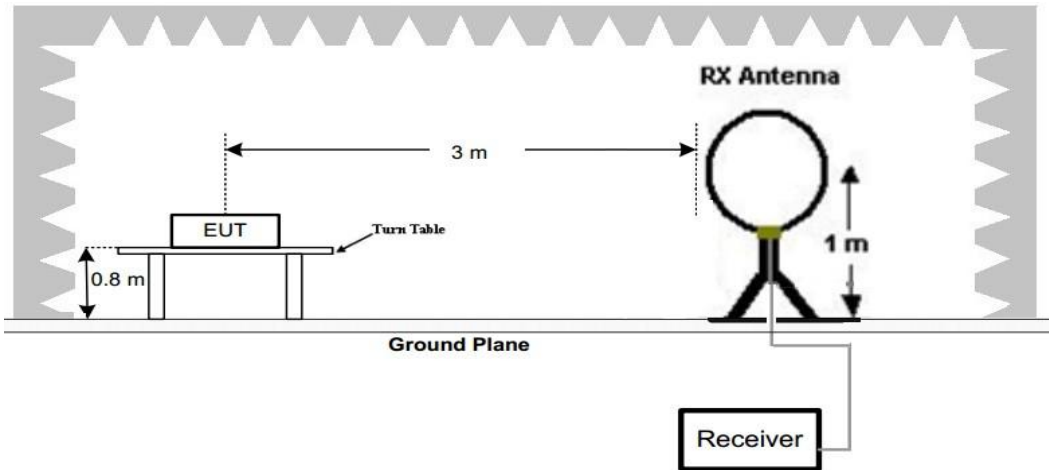

(B) Radiated Emission Test Set-Up, Frequency below 1000MHz

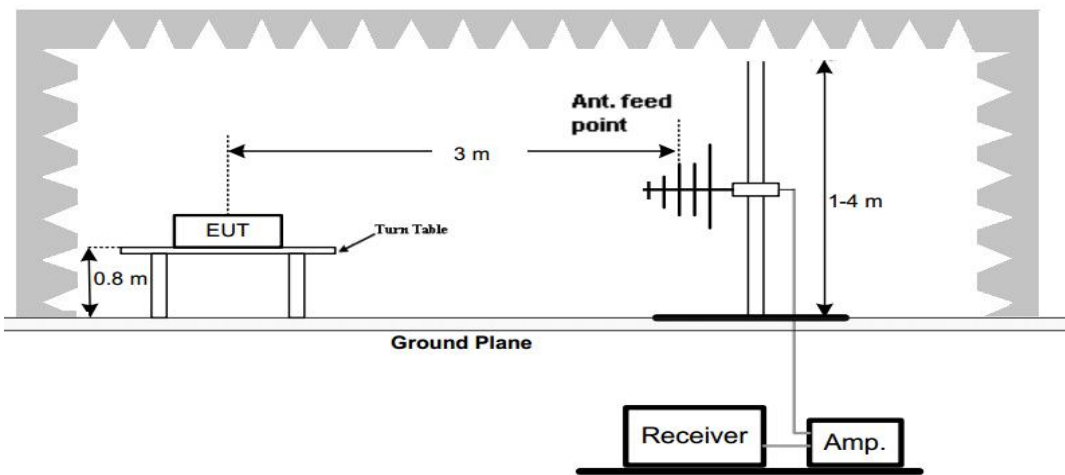

(C) Radiated Emission Test Set-Up, Frequency above 1000MHz

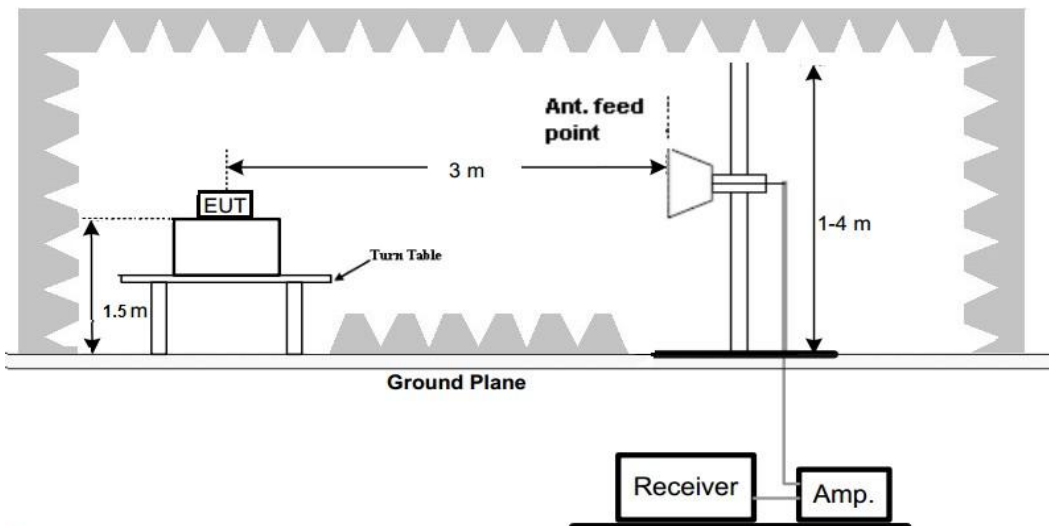

Test Procedure

1. Below 1GHz measurement the EUT is placed on a turntable which is 0.8m above ground plane, and above 1GHz measurement EUT was placed on a low permittivity and low loss tangent turn table which is 1.5m above ground plane.
2. Maximum procedure was performed by raising the receiving antenna from 1m to 4m and rotating the turn table from 0° to 360° to acquire the highest emissions from EUT
3. And also, each emission was to be maximized by changing the polarization of receiving antenna both horizontal and vertical.
4. Repeat above procedures until all frequency measurements have been completed.
5. Radiated emission test frequency band from 9KHz to 40GHz.
6. The distance between test antenna and EUT as following table states:

Test Frequency range	Test Antenna Type	Test Distance
9KHz-30MHz	Active Loop Antenna	3
30MHz-1GHz	Bilog Antenna	3
1GHz-18GHz	Horn Antenna	3
18GHz-25GHz	Horn Antenna	1

7. Setting test receiver/spectrum as following table states:

Test Frequency range	Test Receiver/Spectrum Setting	Detector
9KHz-150KHz	RBW=200Hz/VBW=3KHz, Sweep time=Auto	QP
150KHz-30MHz	RBW=9KHz/VBW=100KHz, Sweep time=Auto	QP
30MHz-1GHz	RBW=120KHz/VBW=1000KHz, Sweep time=Auto	QP
1GHz-40GHz	Peak Value: RBW=1MHz/VBW=3MHz, Sweep time=Auto Average Value: RBW=1MHz/VBW=10Hz, Sweep time=Auto	Peak

TEST RESULTS

Remark:

1. This test was performed with EUT in X, Y, Z position and the worse case was found when EUT in X position.
 1. All 802.11a / 802.11n (HT20) / 802.11n (HT40) modes have been tested for below 1GHz test, only the worst case 802.11a low channel of U-NII 1 band was recorded.
 2. All 802.11a / 802.11n (HT20) / 802.11n (HT40) modes have been tested for above 1GHz test, only the worst case 802.11a was recorded.
 3. Radiated emission test from 9 KHz to 10th harmonic of fundamental was verified, and no emission found except system noise floor in 9 KHz to 30MHz and not recorded in this report.
 4. Remark: Result=Reading value+Factor

For 30MHz-1GHz

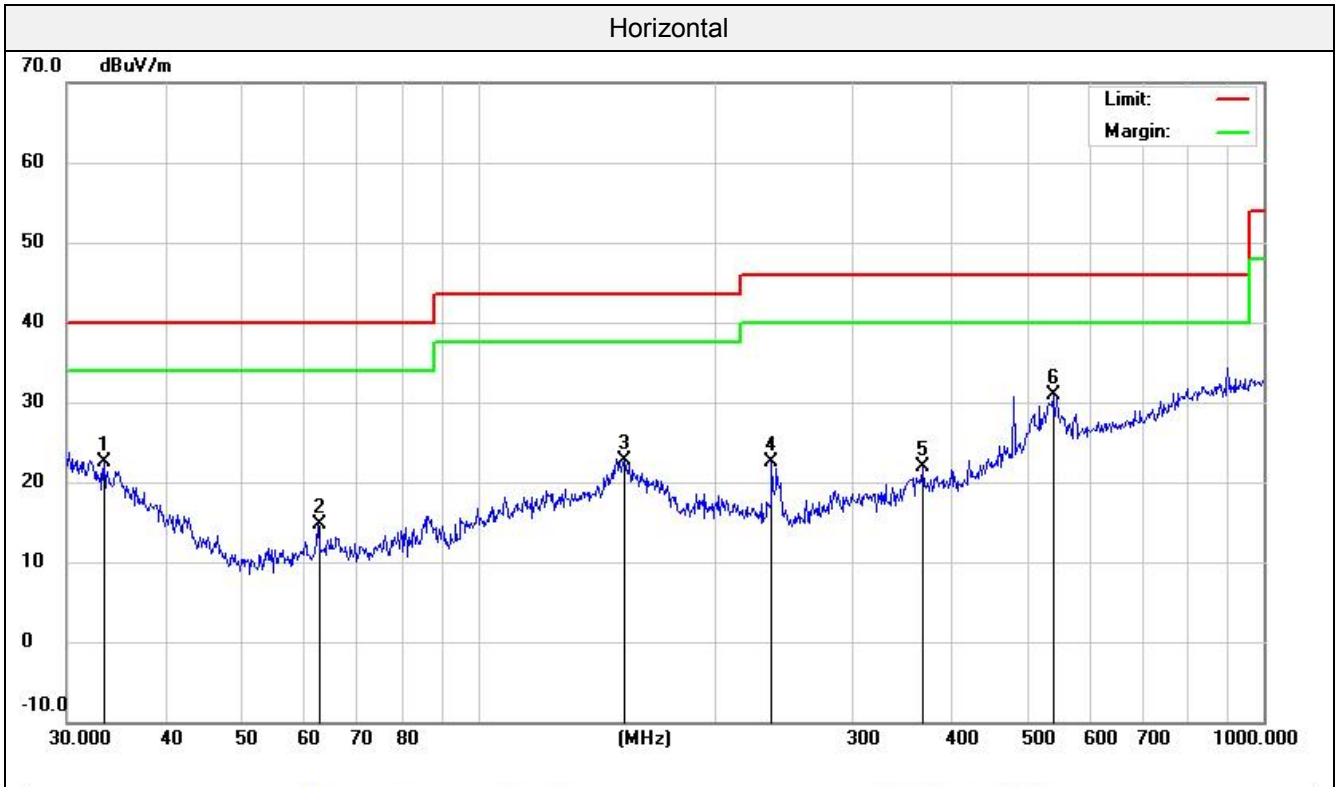

No.	Mk.	Freq. MHz	Reading Level dBuV	Correct Factor dB	Measure- ment dBuV/m	Limit dBuV/m	Over dB	Detector	Antenna Height cm	Table Degree degree	Comment
1		33.4449	4.01	18.56	22.57	40.00	-17.43	QP	200	19	
2		62.6507	6.00	8.79	14.79	40.00	-25.21	QP	200	78	
3		153.7385	5.13	17.55	22.68	43.50	-20.82	QP	200	189	
4		236.6447	8.27	14.17	22.44	46.00	-23.56	QP	200	231	
5		368.1116	5.12	16.79	21.91	46.00	-24.09	QP	200	299	
6	*	539.4775	7.78	23.13	30.91	46.00	-15.09	QP	200	341	

*:Maximum data x:Over limit !:over margin

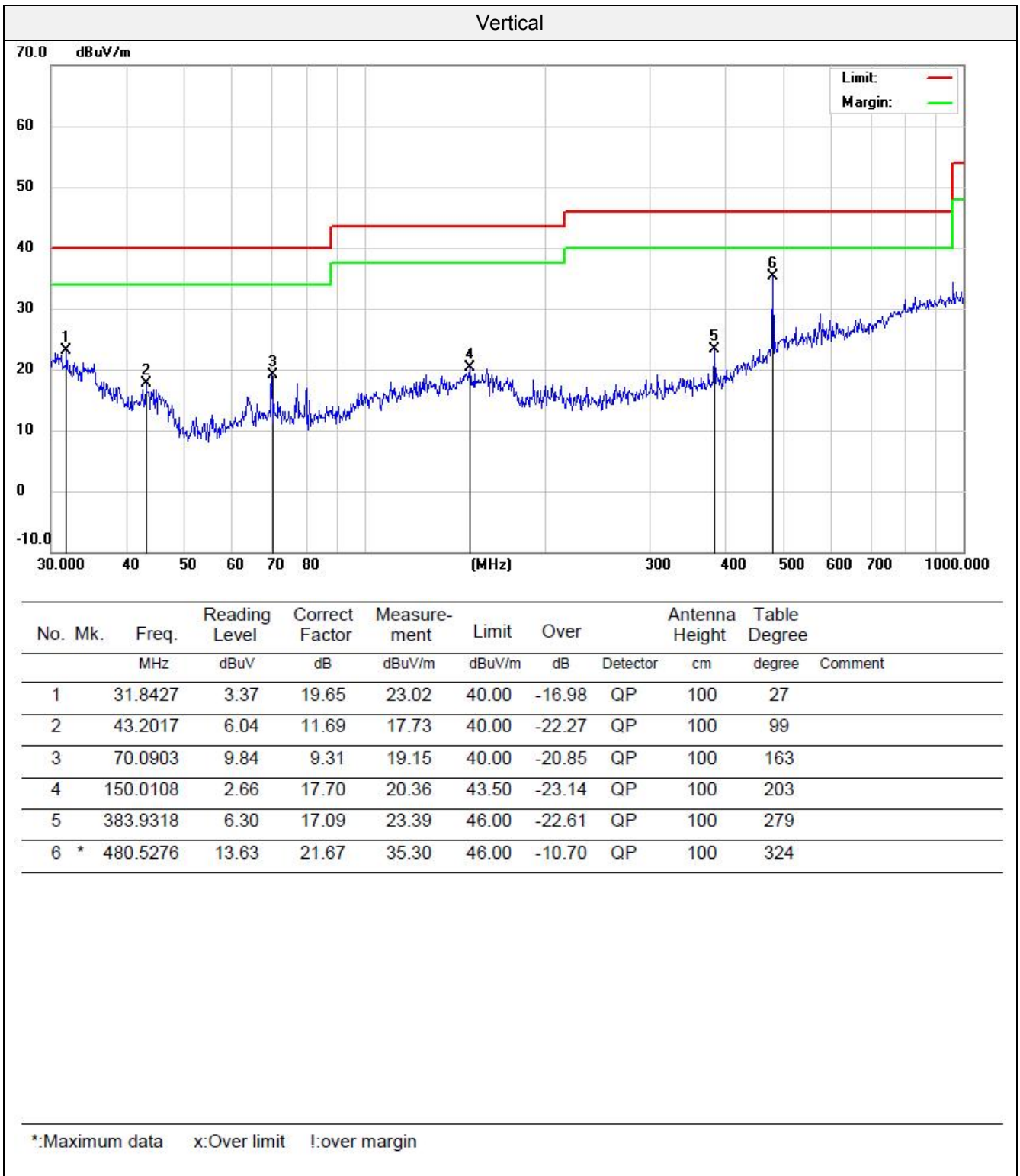

For 1GHz to 40GHz

Note: All 802.11a / 802.11n (HT20) /802.11n (HT40)/ 802.11ac (HT20)/ 802.11ac (HT40)/ 802.11ac (HT80) modes have been tested for above 1GHz test, only the worst case 802.11a was recorded.

Polar (H/V)	Frequency	Meter Reading	Antenna Factor	Cable loss	Preamp factor	Emission Level	Limits	Margin	Detector Type
	(MHz)	(dBuV)	(dB)	(dB)	(dB)	(dBuV/m)	(dBuV/m)	(dB)	
802.11a Mode -5180MHz									
V	3467	53.79	30.36	7.62	36.5	55.27	74	18.73	PK
V	3467	42.13	30.36	7.62	36.5	43.61	54	10.39	AV
H	3467	55.75	30.36	7.62	36.5	57.23	74	16.77	PK
H	3467	42.36	30.36	7.62	36.5	43.84	54	10.16	AV
V	10360	42.59	36.61	8.84	35.3	52.74	74	21.26	PK
V	10360	31.06	36.61	8.84	35.3	41.21	54	12.79	AV
H	10360	40.87	36.61	8.84	35.3	51.02	74	22.98	PK
H	10360	29.26	36.61	8.84	35.3	39.41	54	14.59	AV
802.11a Mode -5200MHz									
V	3467	55.08	30.36	7.62	36.5	56.56	74	17.44	PK
V	3467	40.83	30.36	7.62	36.5	42.31	54	11.69	AV
H	3467	53.26	30.36	7.62	36.5	54.74	74	19.26	PK
H	3467	44.39	30.36	7.62	36.5	45.87	54	8.13	AV
V	10400	41.97	36.61	8.84	35.3	52.12	74	21.88	PK
V	10400	31.61	36.61	8.84	35.3	41.76	54	12.24	AV
H	10400	40.08	36.61	8.84	35.3	50.23	74	23.77	PK
H	10400	29.41	36.61	8.84	35.3	39.56	54	14.44	AV
802.11b Mode -5240MHz									
V	3467	55.85	30.43	7.94	36.2	58.02	74	15.98	PK
V	3467	44.39	30.43	7.94	36.2	46.56	54	7.44	AV
H	3467	53.52	30.43	7.94	36.2	55.69	74	18.31	PK
H	3467	42	30.43	7.94	36.2	44.17	54	9.83	AV
V	10480	40.1	36.78	8.45	35.3	50.03	74	23.97	PK
V	10480	29.54	36.78	8.45	35.3	39.47	54	14.53	AV
H	10480	39.31	36.78	8.45	35.3	49.24	74	24.76	PK
H	10480	29.75	36.78	8.45	35.3	39.68	54	14.32	AV

REMARKS:

1. Emission level (dBuV/m) =Raw Value (dBuV)+Correction Factor (dB/m)
2. Correction Factor (dB/m) = Antenna Factor (dB/m)+Cable Factor (dB)-Pre-amplifier Factor
3. Margin value = Limit value- Emission level.
4. -- Mean the other emission levels were very low against the limit.
5. RBW1MHz VBW3MHz Peak detector is for PK value; RBW 1MHz VBW10Hz Peak detector is for AV value.

Radiated Band Edge Test:

Polar (H/V)	Frequency	Meter Reading	Antenna Factor	Cable loss	Preamp factor	Emission Level	Limits	Margin	Detector Type
	(MHz)	(dBuV)	(dB)	(dB)	(dB)	(dBuV/m)	(dBuV/m)	(dB)	
802.11a -5180MHz									
V	5150	54	31.22	7.62	36.5	56.34	74	17.66	PK
V	5150	38.14	31.22	7.62	36.5	40.48	54	13.52	AV
H	5150	55	31.22	7.62	36.5	57.34	74	16.66	PK
H	5150	43.42	31.22	7.62	36.5	45.76	54	8.24	AV
V	5350	56.14	31.56	7.83	35.82	59.71	74	14.29	PK
V	5350	40.03	31.56	7.83	35.82	43.6	54	10.4	AV
H	5350	55.06	31.56	7.83	35.82	58.63	74	15.37	PK
H	5350	40.8	31.56	7.83	35.82	44.37	54	9.63	AV

Polar (H/V)	Frequency	Meter Reading	Antenna Factor	Cable loss	Preamp factor	Emission Level	Limits	Margin	Detector Type
	(MHz)	(dBuV)	(dB)	(dB)	(dB)	(dBuV/m)	(dBuV/m)	(dB)	
802.11n (HT20) -5180MHz									
V	5150	54.26	31.22	7.62	36.5	56.6	74	17.4	PK
V	5150	38.23	31.22	7.62	36.5	40.57	54	13.43	AV
H	5150	55.29	31.22	7.62	36.5	57.63	74	16.37	PK
H	5150	44.25	31.22	7.62	36.5	46.59	54	7.41	AV
V	5350	54.65	31.56	7.83	35.82	58.22	74	15.78	PK
V	5350	39.46	31.56	7.83	35.82	43.03	54	10.97	AV
H	5350	54.91	31.56	7.83	35.82	58.48	74	15.52	PK
H	5350	40.34	31.56	7.83	35.82	43.91	54	10.09	AV

Polar (H/V)	Frequency	Meter Reading	Antenna Factor	Cable loss	Preamp factor	Emission Level	Limits	Margin	Detector Type
	(MHz)	(dBuV)	(dB)	(dB)	(dB)	(dBuV/m)	(dBuV/m)	(dB)	
802.11n (HT40) -5190MHz									
V	5150	55.25	31.22	7.62	36.5	57.59	74	16.41	PK
V	5150	39.24	31.22	7.62	36.5	41.58	54	12.42	AV
H	5150	54.16	31.22	7.62	36.5	56.5	74	17.5	PK
H	5150	42.01	31.22	7.62	36.5	44.35	54	9.65	AV
V	5350	55.58	31.56	7.83	35.82	59.15	74	14.85	PK
V	5350	39.35	31.56	7.83	35.82	42.92	54	11.08	AV
H	5350	53.96	31.56	7.83	35.82	57.53	74	16.47	PK
H	5350	42.12	31.56	7.83	35.82	45.69	54	8.31	AV

Polar (H/V)	Frequency	Meter Reading	Antenna Factor	Cable loss	Preamp factor	Emission Level	Limits	Margin	Detector Type
	(MHz)	(dBuV)	(dB)	(dB)	(dB)	(dBuV/m)	(dBuV/m)	(dB)	
802.11ac (HT20) -5180MHz									
V	5150	55.97	31.22	7.62	36.5	58.31	74	15.69	PK
V	5150	37.77	31.22	7.62	36.5	40.11	54	13.89	AV
H	5150	54.01	31.22	7.62	36.5	56.35	74	17.65	PK
H	5150	43.37	31.22	7.62	36.5	45.71	54	8.29	AV
V	5350	54.07	31.56	7.83	35.82	57.64	74	16.36	PK
V	5350	38.89	31.56	7.83	35.82	42.46	54	11.54	AV
H	5350	56.09	31.56	7.83	35.82	59.66	74	14.34	PK
H	5350	39.54	31.56	7.83	35.82	43.11	54	10.89	AV

Polar (H/V)	Frequency	Meter Reading	Antenna Factor	Cable loss	Preamp factor	Emission Level	Limits	Margin	Detector Type
	(MHz)	(dBuV)	(dB)	(dB)	(dB)	(dBuV/m)	(dBuV/m)	(dB)	
802.11ac (HT40) -5190MHz									
V	5150	53.92	31.22	7.62	36.5	56.26	74	17.74	PK
V	5150	38.52	31.22	7.62	36.5	40.86	54	13.14	AV
H	5150	54.79	31.22	7.62	36.5	57.13	74	16.87	PK
H	5150	42.98	31.22	7.62	36.5	45.32	54	8.68	AV
V	5350	56.22	31.56	7.83	35.82	59.79	74	14.21	PK
V	5350	40.19	31.56	7.83	35.82	43.76	54	10.24	AV
H	5350	54.16	31.56	7.83	35.82	57.73	74	16.27	PK
H	5350	40.63	31.56	7.83	35.82	44.2	54	9.8	AV

Polar (H/V)	Frequency	Meter Reading	Antenna Factor	Cable loss	Preamp factor	Emission Level	Limits	Margin	Detector Type
	(MHz)	(dBuV)	(dB)	(dB)	(dB)	(dBuV/m)	(dBuV/m)	(dB)	
802.11ac (HT80) -5210MHz									
V	5150	54.98	31.22	7.62	36.5	57.32	74	16.68	PK
V	5150	38.29	31.22	7.62	36.5	40.63	54	13.37	AV
H	5150	55.57	31.22	7.62	36.5	57.91	74	16.09	PK
H	5150	42.03	31.22	7.62	36.5	44.37	54	9.63	AV
V	5350	54.94	31.56	7.83	35.82	58.51	74	15.49	PK
V	5350	39.88	31.56	7.83	35.82	43.45	54	10.55	AV
H	5350	54.58	31.56	7.83	35.82	58.15	74	15.85	PK
H	5350	40.64	31.56	7.83	35.82	44.21	54	9.79	AV

7.3 Conduction spurious emission

Limit

The maximum emissions outside of the frequency bands of operation shall be attenuated in accordance with the following limits:

- (1) For transmitters operating in the 5.15-5.25 GHz band: All emissions outside of the 5.15-5.35 GHz band shall not exceed an e.i.r.p. of -27 dBm/MHz.
- (2) For transmitters operating in the 5.25-5.35 GHz band: All emissions outside of the 5.15-5.35 GHz band shall not exceed an e.i.r.p. of -27 dBm/MHz.
- (3) For transmitters operating in the 5.47-5.725 GHz band: All emissions outside of the 5.47-5.725 GHz band shall not exceed an e.i.r.p. of -27 dBm/MHz.
- (4) For transmitters operating in the 5.725-5.85 GHz band: All emissions shall be limited to a level of -27 dBm/MHz at 75 MHz or more above or below the band edge increasing linearly to 10 dBm/MHz at 25 MHz above or below the band edge, and from 25 MHz above or below the band edge increasing linearly to a level of 15.6 dBm/MHz at 5 MHz above or below the band edge, and from 5 MHz above or below the band edge increasing linearly to a level of 27 dBm/MHz at the band edge.

Test Procedure

Use the following spectrum analyzer settings:

Span = wide enough to capture the peak level of the in-band emission and all spurious emissions (e.g., harmonics) from the lowest frequency generated in the EUT up through the 10th harmonic. Typically, several plots are required to cover this entire span.

RBW = 1 MHz for $f \geq 1$ GHz, 100 kHz for $f < 1$ GHz

VBW \geq RBW

Sweep = auto

Detector function = peak

Trace = max hold

Allow the trace to stabilize

Test Configuration



TEST RESULTS

802.11a



CH36



CH40



CH48

802.11n(HT20)



CH36

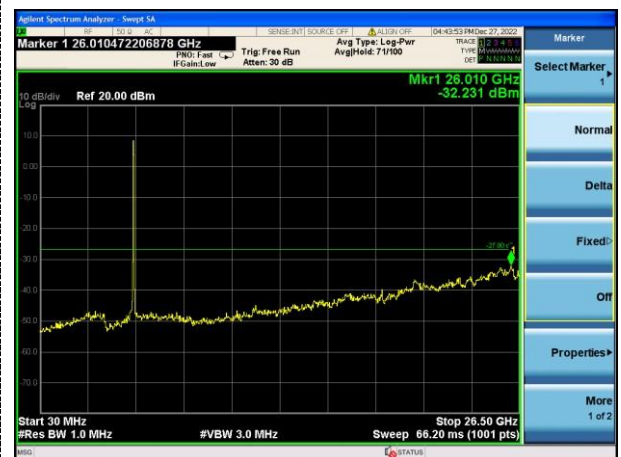

CH40



CH48

802.11n(HT40)



CH38



CH46

802.11ac(HT20)



CH36



CH40



CH48

802.11ac(HT40)



CH38



CH46

802.11ac(HT80)



CH42

Band-edge Measurements for RF Conducted Emissions:

802.11a

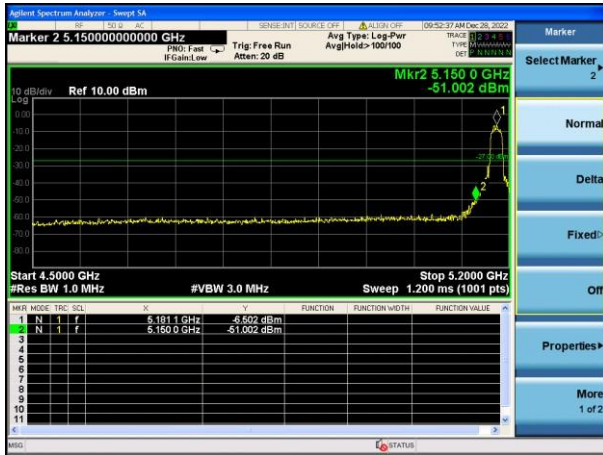

Left bandedge

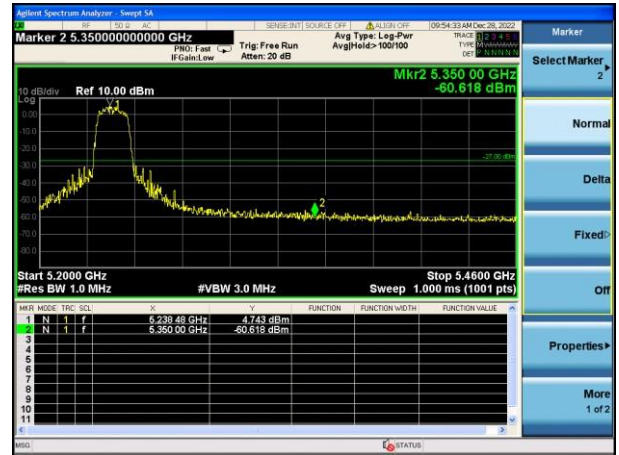

Right bandedge

802.11n(HT20)

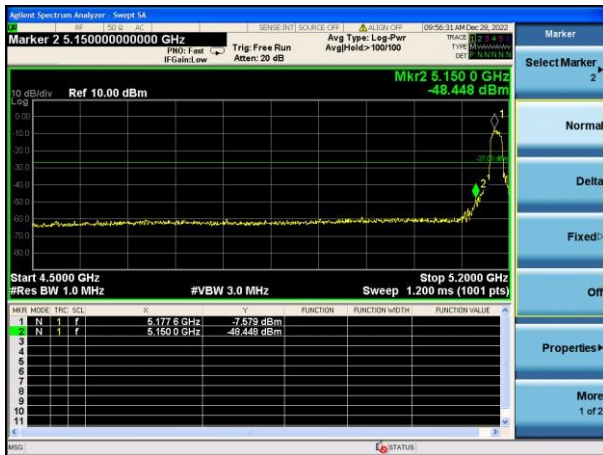

Left bandedge



Right bandedge

802.11n(HT40)

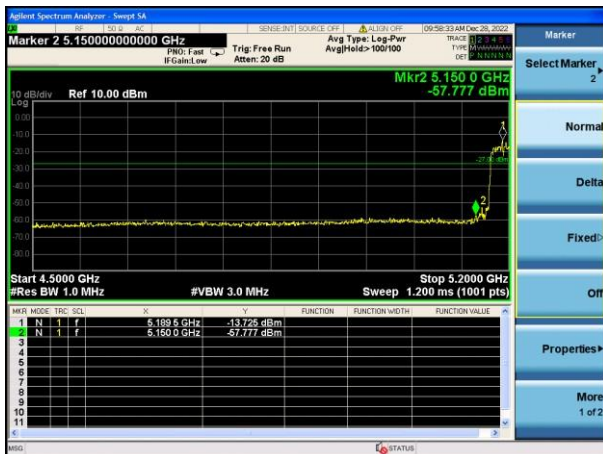

Left bandedge



Right bandedge

802.11ac(HT20)

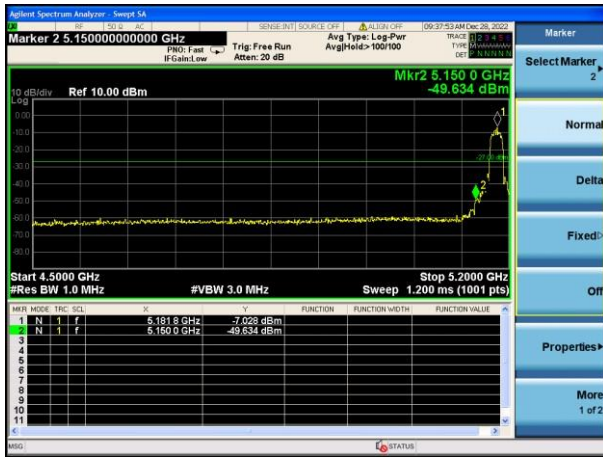

Left bandedge

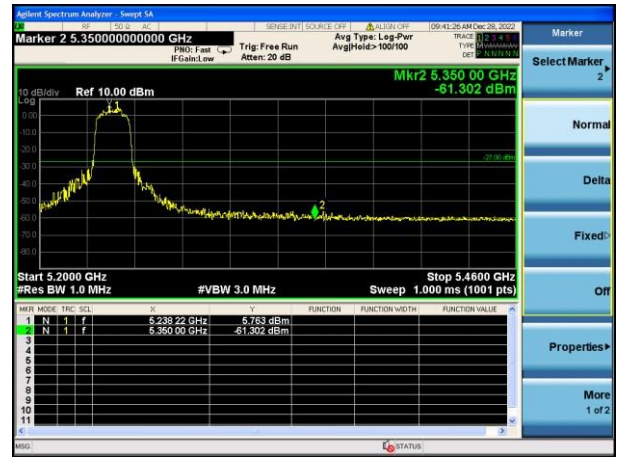

Right bandedge

802.11ac(HT40)

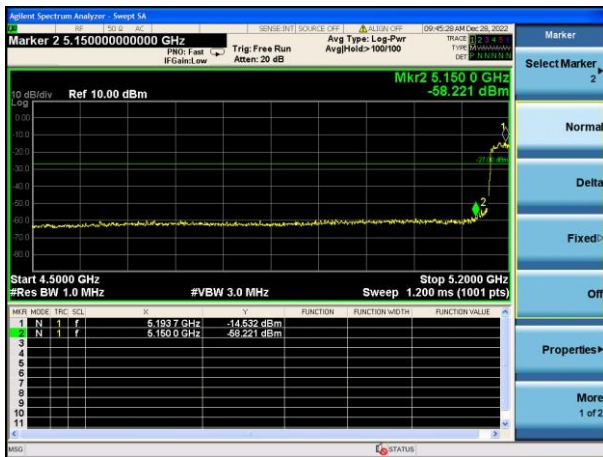

Left bandedge



Right bandedge

802.11ac(HT80)



Left bandedge



Right bandedge

7.4 Maximum Conducted Average Output Power

Limit

For the band 5.15-5.25 GHz.

(i) For an outdoor access point operating in the band 5.15-5.25 GHz, the maximum conducted output power over the frequency band of operation shall not exceed 1 W provided the maximum antenna gain does not exceed 6 dBi.

(ii) For an indoor access point operating in the band 5.15-5.25 GHz, the maximum conducted output power over the frequency band of operation shall not exceed 1 W provided the maximum antenna gain does not exceed 6 dBi.

(iii) For fixed point-to-point access points operating in the band 5.15-5.25 GHz, the maximum conducted output power over the frequency band of operation shall not exceed 1 W.

(iv) For client devices in the 5.15-5.25 GHz band, the maximum conducted output power over the frequency band of operation shall not exceed 250 mW provided the maximum antenna gain does not exceed 6 dBi.

For the 5.25-5.35 GHz and 5.47-5.725 GHz bands, the maximum conducted output power over the frequency bands of operation shall not exceed the lesser of 250 mW or $11 \text{ dBm} + 10 \log B$, where B is the 26 dB emission bandwidth in megahertz.

For the band 5.725-5.85 GHz, the maximum conducted output power over the frequency band of operation shall not exceed 1 W

Test Procedure

Remove the antenna from the EUT and then connect a low loss RF cable from the antenna port to the power sensor.

Test Configuration

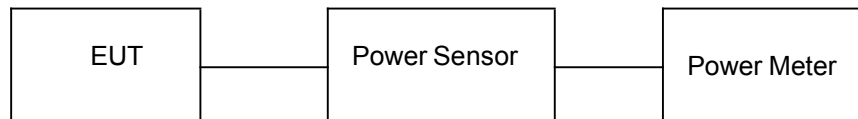

Test Results**U-NII 1**

Type	Channel	Output power (dBm)	Limit (dBm)	Result
802.11a	36	12.55	24.0	Pass
	40	12.22		
	48	13.31		
802.11n(HT20)	36	11.21	24.0	Pass
	40	11.20		
	48	11.52		
802.11n(HT40)	38	10.94	24.0	Pass
	46	10.85		
802.11ac(HT20)	36	10.51	24.0	Pass
	40	10.13		
	48	9.85		
802.11ac(HT40)	38	9.87	24.0	Pass
	46	9.64		
802.11ac(HT80)	42	9.52	24.0	Pass

7.5 Power Spectral Density

Limit

(1) For the band 5.15 - 5.25 GHz.

(i) For an outdoor access point operating in the band 5.15 - 5.25 GHz, the maximum power spectral density shall not exceed 17 dBm in any 1 MHz band. ^{note1}

(ii) For an indoor access point operating in the band 5.15 - 5.25 GHz, the maximum power spectral density shall not exceed 17 dBm in any 1 MHz band. ^{note1}

(iii) For fixed point-to-point access points operating in the band 5.15 - 5.25 GHz, transmitters that employ a directional antenna gain greater than 23 dBi, a 1 dB reduction in maximum power spectral density is required for each 1 dB of antenna gain in excess of 23 dBi.

(iv) For mobile and portable client devices in the 5.15 - 5.25 GHz band, the maximum power spectral density shall not exceed 11 dBm in any 1 MHz band. ^{note1}

(2) For the 5.25 - 5.35 GHz and 5.47 - 5.725 GHz bands, the peak power spectral density shall not exceed 11 dBm in any 1 MHz band. ^{note1}

(3) For the band 5.725 - 5.85 GHz, the maximum power spectral density shall not exceed 30 dBm in any 500 kHz band. ^{note1, note2}

Note1: If transmitting antennas of directional gain greater than 6 dBi are used, the peak power spectral density shall be reduced by the amount in dB that the directional gain of the antenna exceeds 6 dBi.

Note2: Fixed point - to-point U-NII devices operating in this band may employ transmitting antennas with directional gain greater than 6 dBi without any corresponding reduction in transmitter conducted power. Fixed, point-to-point operations exclude the use of point-to-multipoint systems, omnidirectional applications, and multiple collocated transmitters transmitting the same information.

Test Procedure

1. Use this procedure when the maximum peak conducted output power in the fundamental emission is used to demonstrate compliance.
2. Set the RBW = 1MHz for U-NII 1, U-NII 2A, U-NII C band and 510KHz for U-NII 3 band.
3. Set the VBW $\geq 3 \times$ RBW.
4. Set the span to encompass the entire EBW.
5. Detector = peak.
6. Sweep time = auto couple.
7. Trace mode = max hold.
8. Allow trace to fully stabilize.
9. Use the peak marker function to determine the maximum power level.

Test Configuration



Test Results

Type	Bands	Channel	Power Spectral Density (dBm/MHz)	Limit (dBm/MHz)	Result
802.11a	U-NII 1	36	8.987	11.0	Pass
		40	10.365		
		48	9.604		
802.11n (HT20)	U-NII 1	36	9.160		
		40	10.238		
		48	9.417		
802.11n (HT40)	U-NII 1	38	2.693		
		46	5.336		
802.11ac (HT20)	U-NII 1	36	7.822		
		40	7.665		
		48	8.040		
802.11ac (HT40)	U-NII 1	38	1.711		
		46	5.656		
802.11ac (HT80)	U-NII 1	42	3.137		

Remark: P.S.D(dBm/500KHz)= P.S.D(dBm/300KHz)+10 log (500 kHz/300KHz).

Test plot as follows:

802.11a



802.11n(HT20)



CH36



CH36



CH40



CH40



CH48



CH48



802.11n(HT40)



802.11ac(HT20)



CH38



CH36



CH46



CH40



CH48

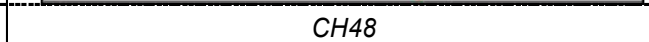

802.11ac(HT40)



802.11ac(HT80)



CH38



CH42



CH46

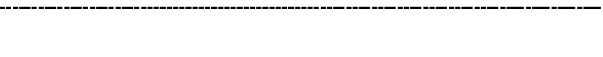

7.6 Emission Bandwidth (26dBm Bandwidth)

Limit

N/A

Test Procedure

1. Set resolution bandwidth (RBW) = approximately 1 % of the EBW.
2. Set the video bandwidth (VBW) > RBW.
3. Detector = Peak.
4. Trace mode = Max hold.
5. Measure the maximum width of the emission that is 26 dB down from the peak of the emission. Compare this with the RBW setting of the analyzer. Readjust RBW and repeat measurement as needed until the RBW / EBW ratio is approximately 1 %.

Test Configuration



Test Results

Type	Bands	Channel	26dB Bandwidth (MHz)	Limit (MHz)	Result
802.11a	U-NII 1	36	19.91	N/A	Pass
		40	19.25		
		48	19.56		
802.11n(HT20)	U-NII 1	36	19.65		
		40	19.76		
		48	19.66		
802.11n(HT40)	U-NII 1	38	38.61		
		46	39.99		
802.11ac(HT20)	U-NII 1	36	20.39		
		40	19.90		
		48	19.71		
802.11ac(HT40)	U-NII 1	38	39.17		
		46	39.69		
802.11ac(HT80)	U-NII 1	42	99.71		

Test plot as follows:

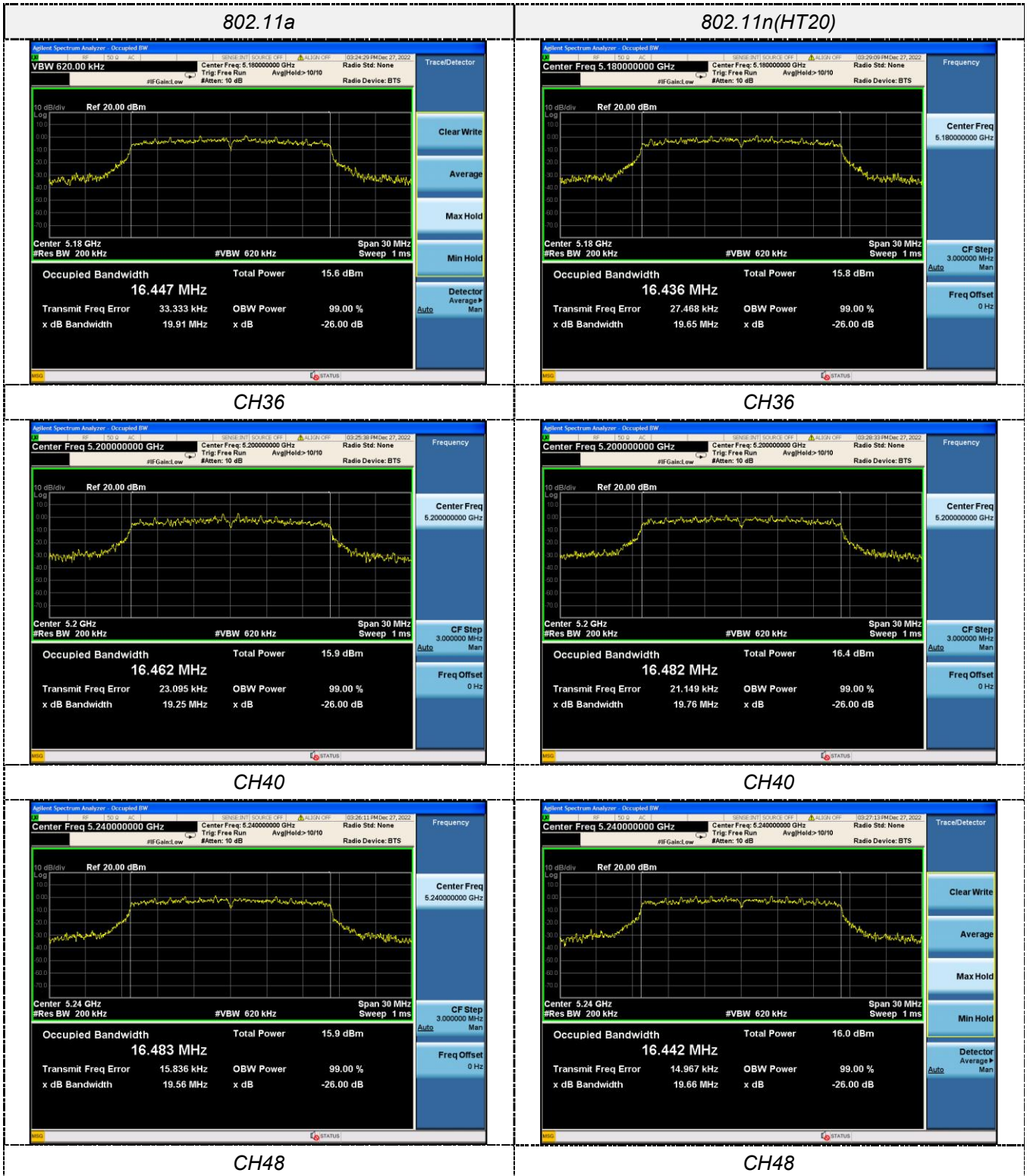

802.11n(HT40)



802.11ac(HT20)



CH38

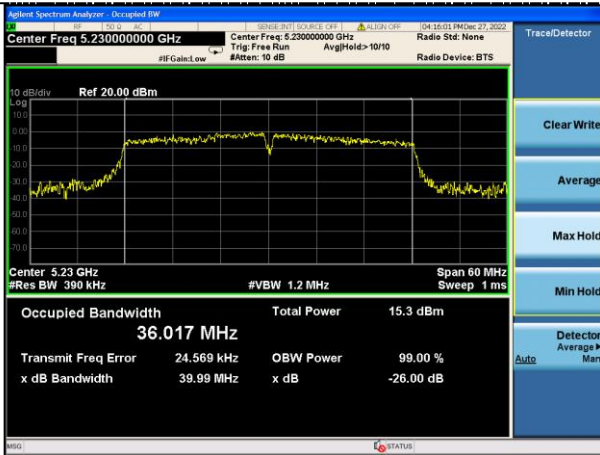

CH36

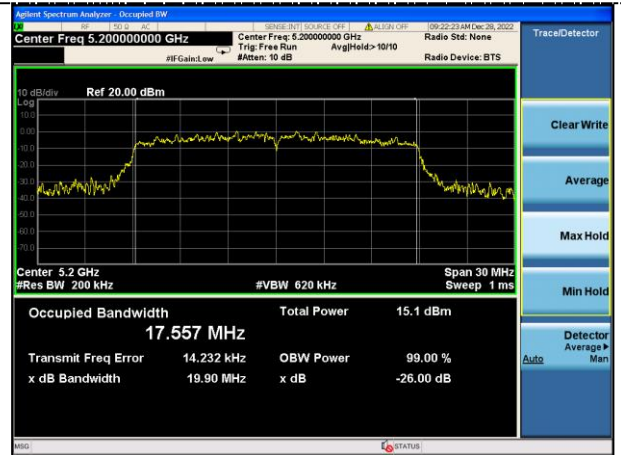

CH46

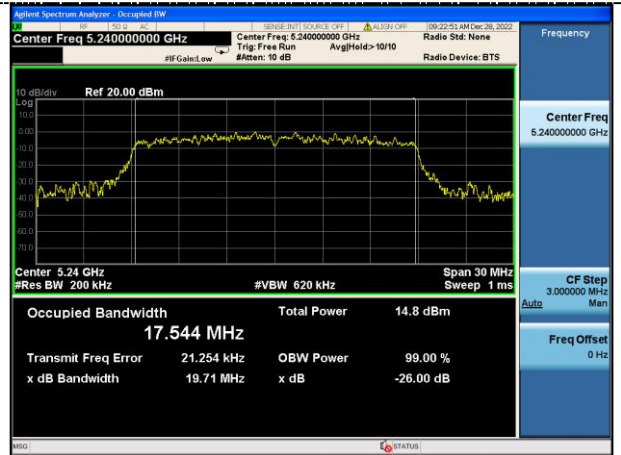

CH48

802.11ac(HT40)



CH38

802.11ac(HT80)

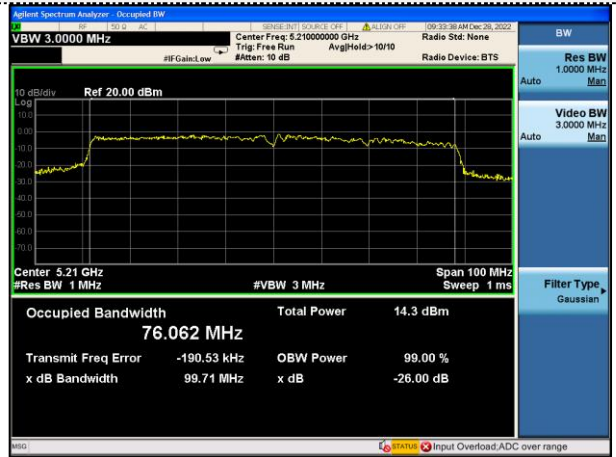

CH42



CH46

7.7 Minimum Emission Bandwidth (6dBm Bandwidth)

Limit

Within the 5.725-5.85 GHz band, the minimum 6 dB bandwidth of U-NII devices shall be at least 500 kHz.

Test Procedure

1. Set resolution bandwidth (RBW) = 100 kHz
2. Set the video bandwidth 3 x RBW.
3. Detector = Peak.
4. Trace mode = Max hold.
5. Measure the maximum width of the emission that is constrained by the frequencies associated with the two outermost amplitude points (upper and lower frequencies) that are attenuated by 6 dB relative to the maximum level measured in the fundamental emission.

Test Configuration



Test Results

N/A

7.8 Frequency Stability

LIMIT

Manufacturers of U-NII devices are responsible for ensuring frequency stability such that an emission is maintained within the band of operation under all conditions of normal operation as specified in the users manual.

TEST CONFIGURATION

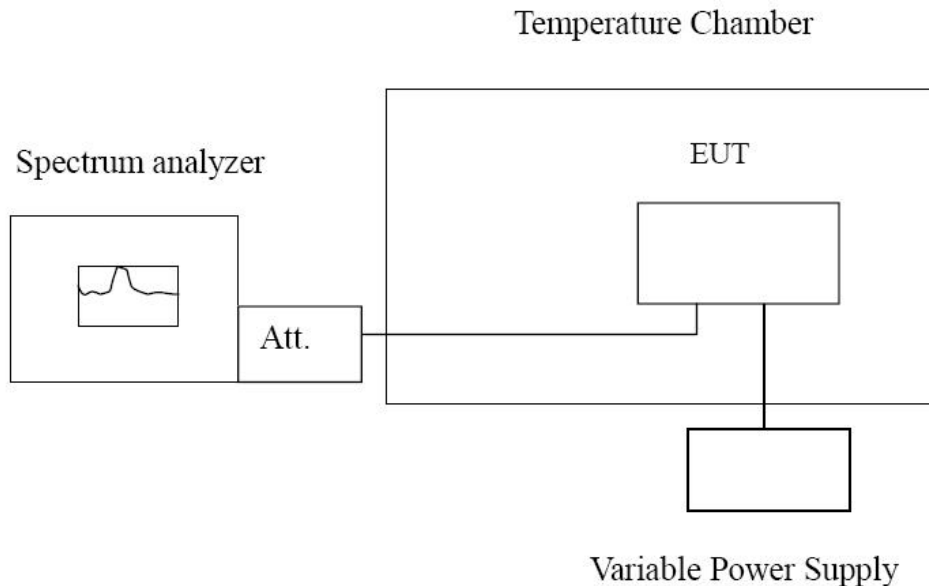

TEST PROCEDURE

Frequency Stability under Temperature Variations:

The equipment under test was connected to an external AC or DC power supply and input rated voltage. RF output was connected to a frequency counter or spectrum analyzer via feed through attenuators. The EUT was placed inside the temperature chamber. Set the spectrum analyzer RBW low enough to obtain the desired frequency resolution and measure EUT 20°C operating frequency as reference frequency. Turn EUT off and set the chamber temperature to -30°C. After the temperature stabilized for approximately 30 minutes recorded the frequency. Repeat step measure with 10°C increased per stage until the highest temperature of +50°C reached.

Frequency Stability under Voltage Variations:

Set chamber temperature to 20°C. Use a variable AC power supply / DC power source to power the EUT and set the voltage to rated voltage. Set the spectrum analyzer RBW low enough to obtain the desired frequency resolution and recorded the frequency.

Reduce the input voltage to specify extreme voltage variation ($\pm 15\%$) and endpoint, record the maximum frequency change.

TEST RESULTS

Record worst case as below:

Reference Frequency: 802.11a channel=36 frequency=5180MHz					
Voltage (V)	Temperature (°C)	Frequency error		Limit (ppm)	Result
		MHz	ppm		
5.00	-30	0.0136	-2.6274	Within the band of operation	Pass
	-20	0.0102	-1.9691		
	-10	0.0126	-2.4324		
	0	0.0130	-2.5097		
	10	0.0123	-2.3745		
	20	0.0134	-2.5869		
	30	0.0110	-2.1236		
	40	0.0123	-2.3745		
	50	0.0140	-2.7027		
5.75	25	0.0143	-2.7606		
4.25	25	0.0112	-2.1622		

7.9 Duty Cycle Information

Test Mode	U-NII 1			Duty Cycle Correction Factor [dB]
	Maximum Achievable Duty Cycle (x) = On / (On+Off)			
	On Time [ms]	(On+Off) Time [ms]	x	
a	0.364	0.390	93.33%	0.062
n20	1.302	1.338	97.30%	0.051
n40	0.654	0.690	94.78%	0.062
ac20	0.672	0.708	94.92%	0.062
ac40	0.648	0.684	94.74%	0.052
ac80	0.378	0.402	94.10%	0.035

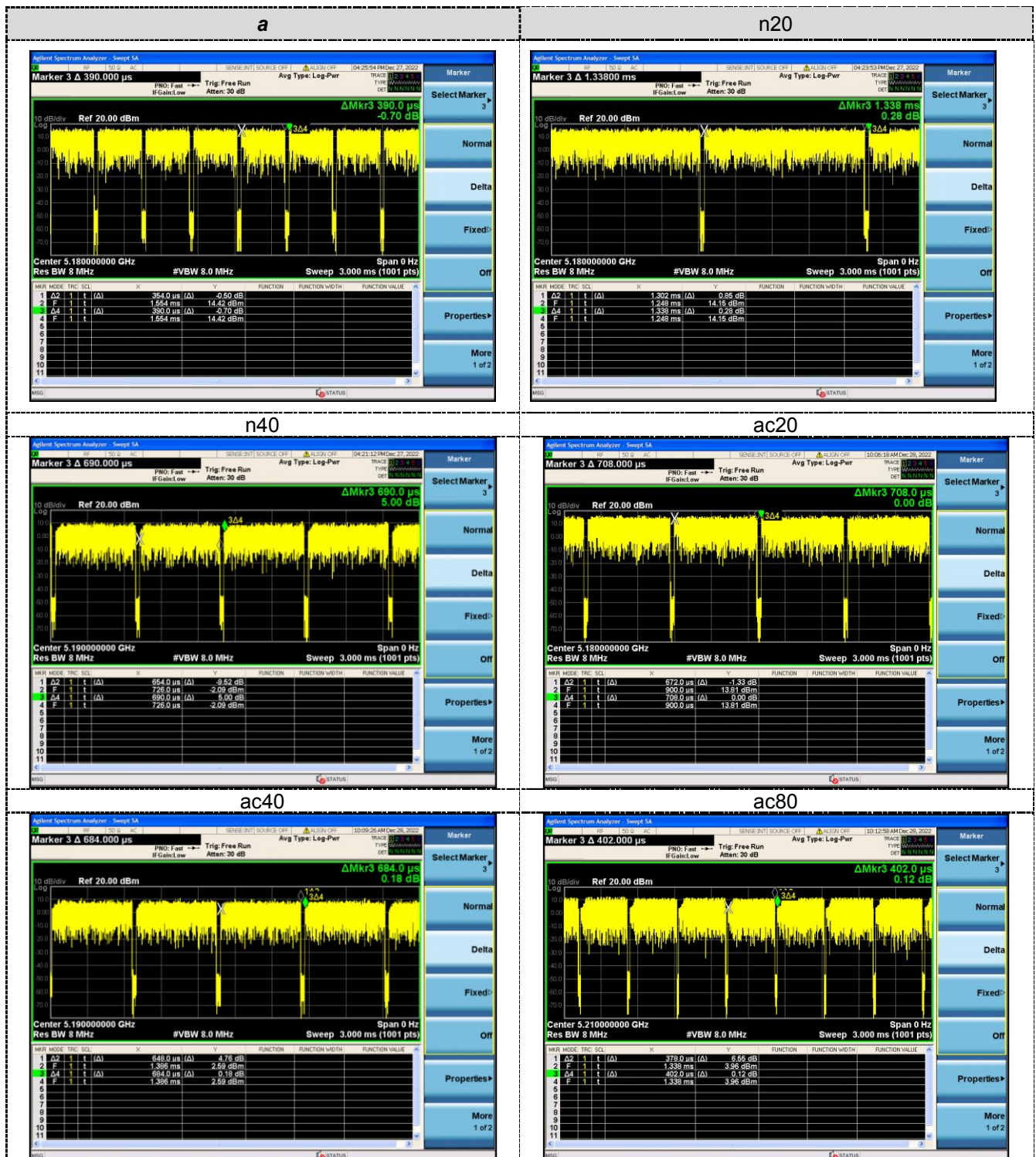

7.10 Antenna Requirement

Standard Applicable

For intentional device, according to FCC 47 CFR Section 15.203:

An intentional radiator shall be designed to ensure that no antenna other than that furnished by the responsible party shall be used with the device. The use of a permanently attached antenna or of an antenna that uses a unique coupling to the intentional radiator, the manufacturer may design the unit so that a broken antenna can be replaced by the user, but the use of a standard antenna jack or electrical connector is prohibited.

FCC CFR Title 47 Part 15 Subpart C Section 15.407::

An intentional radiator shall be designed to ensure that no antenna other than that furnished by the responsible party shall be used with the device. The use of a permanently attached antenna or of an antenna that uses a unique coupling to the intentional radiator shall be considered sufficient to comply with the provisions of this section. The manufacturer may design the unit so that a broken antenna can be replaced by the user, but the use of a standard antenna jack or electrical connector is prohibited. This requirement does not apply to carrier current devices or to devices operated under the provisions of §15.211, §15.213,

§15.217, §15.219, or §15.221. Further, this requirement does not apply to intentional radiators that must be professionally installed, such as perimeter protection systems and some field disturbance sensors, or to other intentional radiators which, in accordance with §15.31(d), must be measured at the installation site. However, the installer shall be responsible for ensuring that the proper antenna is employed so that the limits in this part are not exceeded.

Test Result:

The directional gains of antenna used for transmitting is 3.8 dBi, and the antenna is an internal antenna connect to FPC Antenna and no consideration of replacement. Please see EUT photo for details.

Results: Compliance.

8 Test Setup Photos of the EUT

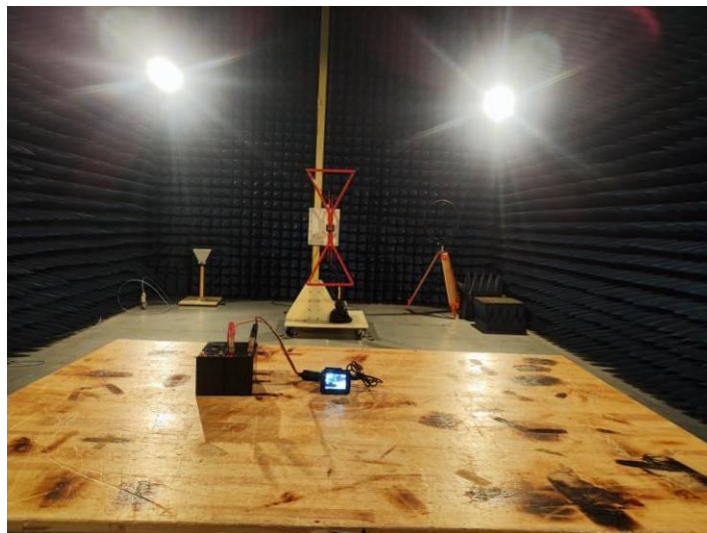

9 Photos of the EUT

See related photo report.

***** End of Report *****