



RF TEST REPORT

Applicant Quectel Wireless Solutions Co., Ltd
FCC ID XMR2020BG95M1
Product LTE Cat M1 Module
Brand Quectel
Marketing Quectel BG95-M1
Model BG95-M1
Report No. R1907A0450-R1V2
Issue Date March 13, 2020

TA Technology (Shanghai) Co., Ltd. tested the above equipment in accordance with the requirements in **FCC CFR47 Part 2 (2019)/ FCC CFR 47 Part 22H (2019)**. The test results show that the equipment tested is capable of demonstrating compliance with the requirements as documented in this report.

Performed by: Peng Tao

Approved by: Kai Xu

TA Technology (Shanghai) Co., Ltd.

No.145, Jintang Rd, Tangzhen Industry Park, Pudong Shanghai, China

TEL: +86-021-50791141/2/3

FAX: +86-021-50791141/2/3-8000



TABLE OF CONTENT

1. Test Laboratory	4
1.1. Notes of the Test Report	4
1.2. Test facility	4
1.3. Testing Location	5
2. General Description of Equipment under Test	6
3. Applied Standards	7
4. Test Configuration	8
5. Test Case Results	9
5.1. RF Power Output and Effective Radiated Power	9
5.2. Occupied Bandwidth	12
5.3. Band Edge Compliance	16
5.4. Peak-to-Average Power Ratio (PAPR)	23
5.5. Frequency Stability	25
5.6. Spurious Emissions at Antenna Terminals	28
5.7. Radiates Spurious Emission	34
6. Main Test Instruments	39
ANNEX A: Product Change Description	40

Summary of measurement results

No.	Test Case	Clause in FCC rules	Verdict
1	RF Power Output and Effective Radiated Power	2.1046 22.913(a)(5)	PASS
2	Occupied Bandwidth	2.1049	PASS
3	Band Edge Compliance	2.1051 / 22.917(a)	Refer to the Original
4	Peak-to-Average Power Ratio	22.913(d)/ KDB 971168 D01(5.7)	Refer to the Original
5	Frequency Stability	2.1055 / 22.355	Refer to the Original
6	Spurious Emissions at Antenna Terminals	2.1051 / 22.917(a)	Refer to the Original
7	Radiates Spurious Emission	2.1053 / 22.917 (a)	PASS

Date of Testing: August 20, 2019 ~ September 5, 2019 and December 25, 2019 ~ January 8, 2020

Note: All indications of Pass/Fail in this report are opinions expressed by TA Technology (Shanghai) Co., Ltd. based on interpretations and/or observations of test results. Measurement Uncertainties were not taken into account and are published for informational purposes only.

Note: This revised report (Report No.: R1907A0450-R1V2) supersedes and replaces the previously issued report (Report No.: R1907A0450- R1V1). Please discard or destroy the previously issued report and dispose of it accordingly.

BG95-M1 (Report No.: R1907A0450-R1V2) is a variant model of BG95-M3 (Report No.: R1907A0446-R1V1). Test values partial duplicated from Original for variant. There is only tested RF Power Output, Effective Radiated Power, Occupied Bandwidth and Radiates Spurious Emission for variant in this report. The detailed product change description please refers to the ANNEX A.



1. Test Laboratory

1.1. Notes of the Test Report

This report shall not be reproduced in full or partial, without the written approval of **TA technology (shanghai) co., Ltd.** The results documented in this report apply only to the tested sample, under the conditions and modes of operation as described herein .Measurement Uncertainties were not taken into account and are published for informational purposes only. This report is written to support regulatory compliance of the applicable standards stated above.

1.2. Test facility

FCC (Designation number: CN1179, Test Firm Registration Number: 446626)

TA Technology (Shanghai) Co., Ltd. has been listed on the US Federal Communications Commission list of test facilities recognized to perform electromagnetic emissions measurements.

A2LA (Certificate Number: 3857.01)

TA Technology (Shanghai) Co., Ltd. has been listed by American Association for Laboratory Accreditation to perform electromagnetic emission measurement.



1.3. Testing Location

Company: TA Technology (Shanghai) Co., Ltd.
Address: No.145, Jintang Rd, Tangzhen Industry Park, Pudong
City: Shanghai
Post code: 201201
Country: P. R. China
Contact: Xu Kai
Telephone: +86-021-50791141/2/3
Fax: +86-021-50791141/2/3-8000
Website: <http://www.ta-shanghai.com>
E-mail: xukai@ta-shanghai.com

2. General Description of Equipment under Test

Client Information

Applicant	Quectel Wireless Solutions Co., Ltd
Applicant address	Building 5, Shanghai Business Park Phase III (Area B), No.1016 Tianlin Road, Minhang District, Shanghai, China 200233
Manufacturer	Quectel Wireless Solutions Co., Ltd
Manufacturer address	Building 5, Shanghai Business Park Phase III (Area B), No.1016 Tianlin Road, Minhang District, Shanghai, China 200233

General Information

EUT Description			
Model	BG95-M1		
IMEI	864622040009090		
Hardware Version	R2.1		
Software Version	BG95M1LAR02A02		
Power Supply	External power supply		
Antenna Type	The EUT don't have standard Antenna, The Antenna used for testing in this report is the after-market accessory (Dipole Antenna)		
Antenna Gain	LTE Band 5: 3dBi		
Test Mode(s)	LTE Band 5		
Test Modulation	QPSK, 16QAM;		
LTE Category	M1		
Maximum E.R.P.	LTE Band 5:	21.50dBm	
Rated Power Supply Voltage	3.3V		
Extreme Voltage	Minimum: 2.6V Maximum: 4.8V		
Extreme Temperature	Lowest: -40°C Highest: +85°C		
Operating Frequency Range(s)	Band	Tx (MHz)	Rx (MHz)
	LTE Band 5	824 ~ 849	869 ~ 894
Note: The EUT is sent from the applicant to TA and the information of the EUT is declared by the applicant.			



3. Applied Standards

According to the specifications of the manufacturer, it must comply with the requirements of the following standards:

Test standards:

FCC CFR 47 Part 22H (2019)

ANSI C63.26 (2015)

Reference standard:

FCC CFR47 Part 2 (2019)

KDB 971168 D01 Power Meas License Digital Systems v03r01

4. Test Configuration

Radiated measurements are performed by rotating the EUT in three different orthogonal test planes. EUT stand-up position (Z axis), lie-down position (X, Y axis). Receiver antenna polarization (horizontal and vertical), the worst emission was found in position (X axis, horizontal polarization) and the worst case was recorded.

All mode and data rates and positions were investigated. Subsequently, only the worst case emissions are reported.

The following testing in GSM/ LTE is set based on the maximum RF Output Power.

Test modes are chosen as the worst case configuration below for LTE Band 5.

Test items	Modes	Bandwidth (MHz)				Modulation		RB			Test Channel			
		1.4	3	5	10	QPSK	16QAM	1	50%	100%	L	M	H	
RF Power Output and Effective Radiated Power	LTE 5	O	O	O	O	O	O	O	O	O	O	O	O	O
Occupied Bandwidth	LTE 5	O	O	O	O	O	O	-	-	O	-	O	-	
Band Edge Compliance	LTE 5	O	O	O	O	O	O	O	-	O	O	-	O	
Peak-to-Average Power Ratio	LTE 5	O	O	O	O	O	O	-	-	O	-	O	-	
Frequency Stability	LTE 5	O	O	O	O	O	O	O	O	O	O	O	O	
Spurious Emissions at Antenna Terminals	LTE 5	O	O	O	O	O	-	O	-	-	O	O	O	
Radiates Spurious Emission	LTE 5	O	-	O	O	O	-	O	-	-	-	O	-	
Note	1. The mark "O" means that this configuration is chosen for testing. 2. The mark "-" means that this configuration is not testing.													

5. Test Case Results

5.1. RF Power Output and Effective Radiated Power

Ambient condition

Temperature	Relative humidity	Pressure
23°C ~25°C	45%~50%	101.5kPa

Methods of Measurement

During the process of the testing, The EUT is controlled by the Base Station Simulator to ensure max power transmission and proper modulation.

The testing follows FCC KDB 971168 v03r01 Section 5.8 and ANSI C63.26 (2015).

- a) Connect the equipment as illustrated. Mount the equipment with the manufacturer specified antenna in a vertical orientation on a manufacturer specified mounting surface located on a non-conducting rotating platform of a RF anechoic chamber (preferred) or a standard radiation site.
- b) Key the transmitter, then rotate the EUT 360° azimuthally and record spectrum analyzer power level (LVL) measurements at angular increments that are sufficiently small to permit resolution of all peaks. If a standard radiation test site is used, raise and lower the test antenna to obtain a maximum reading at each angular increment. (Note: several batteries may be needed to offset the effect of battery voltage droop, which should not exceed 5% of the manufactured specified battery voltage during transmission).
- c) Replace the transmitter under test with a vertically polarized half-wave dipole (or an antenna whose gain is known relative to an ideal half-wave dipole). The center of the antenna should be at the same location as the center of the antenna under test.
- d) Connect the antenna to a signal generator with a known output power and record the path loss (in dB) as LOSS. If a standard radiation test site is used, raise and lower the test antenna to obtain a maximum reading. $LOSS = \text{Generator Output Power (dBm)} - \text{Analyzer reading (dBm)}$
- e) Determine the effective radiated output power at each angular position from the readings in steps b) and d) using the following equation: $ERP \text{ (dBm)} = \text{LVL (dBm)} + \text{LOSS (dB)}$
- f) The maximum ERP is the maximum value determined in the preceding step.
- g) When calculating ERP, in addition to knowing the antenna radiation and matching characteristics, it is necessary to know the loss values of all elements (e.g. transmission line attenuation, mismatches, filters, combiners) interposed between the point where transmitter output power is measured, and the point where power is applied to the antenna. ERP can then be calculated as follows:
 $EIRP \text{ (dBm)} = \text{Output Power (dBm)} - \text{Losses (dB)} + \text{Antenna Gain (dBi)}$
 where: dBd refers to gain relative to an ideal dipole.
 $EIRP \text{ (dBm)} = ERP \text{ (dBm)} + 2.15 \text{ (dB.)}$

The RB allocation refers to section 5.1, using the maximum output power configuration.

Test Setup

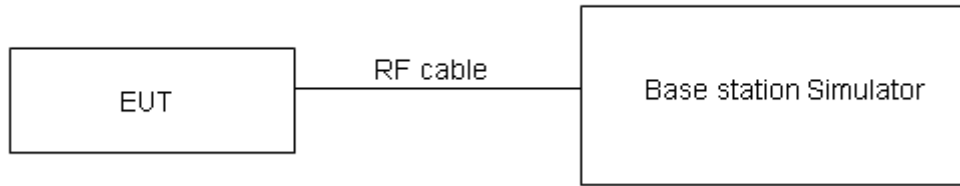

The loss between RF output port of the EUT and the input port of the tester has been taken into consideration.

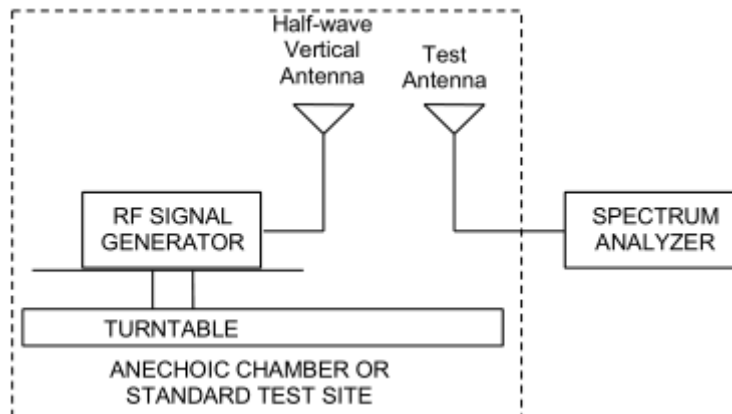
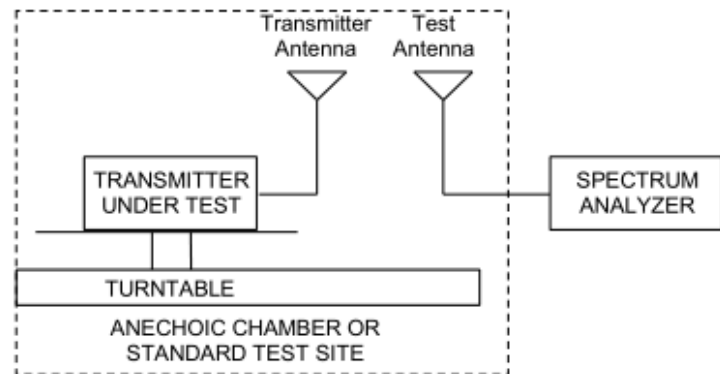

Limits

No specific RF power output requirements in part 2.1046.

Rule Part 22.913(a)(5) specifies that "Mobile/portable stations are limited to 7 watts ERP".

Limit	$\leq 7 \text{ W}$ (38.45 dBm)
-------	--------------------------------

Measurement Uncertainty

The assessed measurement uncertainty to ensure 95% confidence level for the normal distribution is with the coverage factor $k = 2$, $U = 0.4 \text{ dB}$ for RF power output, $k = 2$, $U = 1.19 \text{ dB}$ for ERP .

**Test Results**

Variant:

LTE Band5	Channel/ Frequency(MHz)	Index	RB# RBstart	Conducted Power (dBm)		ERP	
				QPSK	16QAM	QPSK	16QAM
1.4MHz	20407/824.7	0	1#0	19.83	19.55	20.68	20.40
		0	6#0	18.17	17.89	19.02	18.74
	20525/836.5	0	1#0	20.65	18.97	21.50	19.82
		0	6#0	18.31	19.30	19.16	20.15
	20643/848.3	0	1#5	20.37	18.81	21.22	19.66
		0	6#0	17.99	18.78	18.84	19.63
3MHz	20415/825.5	0	1#0	20.31	18.90	21.16	19.75
		0	6#0	18.02	18.37	18.87	19.22
	20525/836.5	0	1#0	20.53	19.13	21.38	19.98
		0	6#0	18.31	18.51	19.16	19.36
	20635/847.5	1	1#5	20.40	19.02	21.25	19.87
		1	6#0	18.02	18.34	18.87	19.19
5MHz	20425/826.5	0	1#0	20.04	19.77	20.89	20.62
		0	6#0	19.11	19.35	19.96	20.20
	20525/836.5	0	1#0	20.42	20.04	21.27	20.89
		0	6#0	19.31	19.60	20.16	20.45
	20625/846.5	3	1#5	20.20	19.90	21.05	20.75
		3	6#0	19.23	19.41	20.08	20.26
10MHz	20450/829	0	1#0	20.25	19.78	21.10	20.63
		0	4#0	20.19	20.56	21.04	21.41
	20525/836.5	0	1#0	20.41	19.93	21.26	20.78
		0	4#0	20.31	20.46	21.16	21.31
	20600/844	7	1#5	20.14	19.81	20.99	20.66
		7	4#2	20.33	20.28	21.18	21.13

5.2. Occupied Bandwidth

Ambient condition

Temperature	Relative humidity	Pressure
23°C ~25°C	45%~50%	101.5kPa

Method of Measurement

The EUT was connected to Spectrum Analyzer and Base Station Simulator via power Splitter. The occupied bandwidth is measured using spectrum analyzer.

RBW is set to 3kHz, VBW is set to 10kHz for GSM 850,

RBW is set to 51kHz, VBW is set to 160kHz for LTE Band 5.

99% power and -26dBc occupied bandwidths are recorded. Spectrum analyzer plots are included on the following pages.

Test Setup

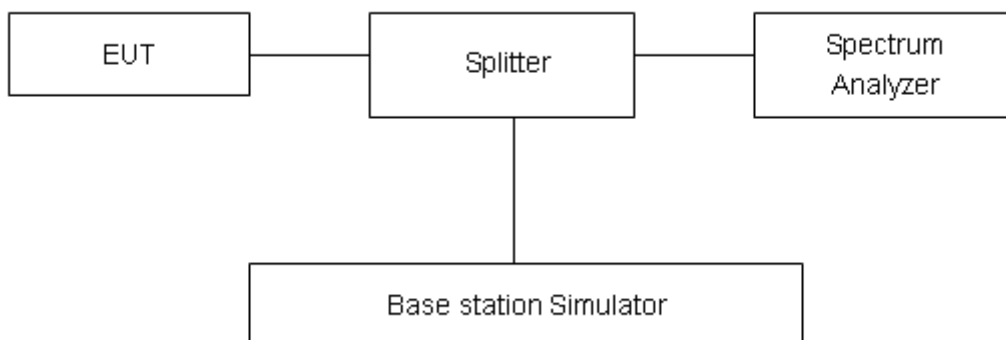

Limits

No specific occupied bandwidth requirements in part 2.1049.

Measurement Uncertainty

The assessed measurement uncertainty to ensure 95% confidence level for the normal distribution is with the coverage factor $k = 2$, $U = 624\text{Hz}$.

**Test Result****Variant:**

Mode	Bandwidth	Modulation	Channel/ Frequency(MHz)	RB	Index	Bandwidth(MHz)	
						99% Power	-26dBc
Band5	1.4MHz	QPSK	20525/836.5	6#0	0	1.1064	1.359
		16QAM	20525/836.5	6#0	0	0.9404	1.130
	3MHz	QPSK	20525/836.5	6#0	0	1.1146	1.342
		16QAM	20525/836.5	6#0	0	0.9431	1.163
	5MHz	QPSK	20525/836.5	6#0	0	1.1067	1.306
		16QAM	20525/836.5	6#0	0	0.9401	1.220
	10MHz	QPSK	20525/836.5	6#0	0	1.1212	1.316
		16QAM	20525/836.5	6#0	0	0.9595	1.194



Variants:

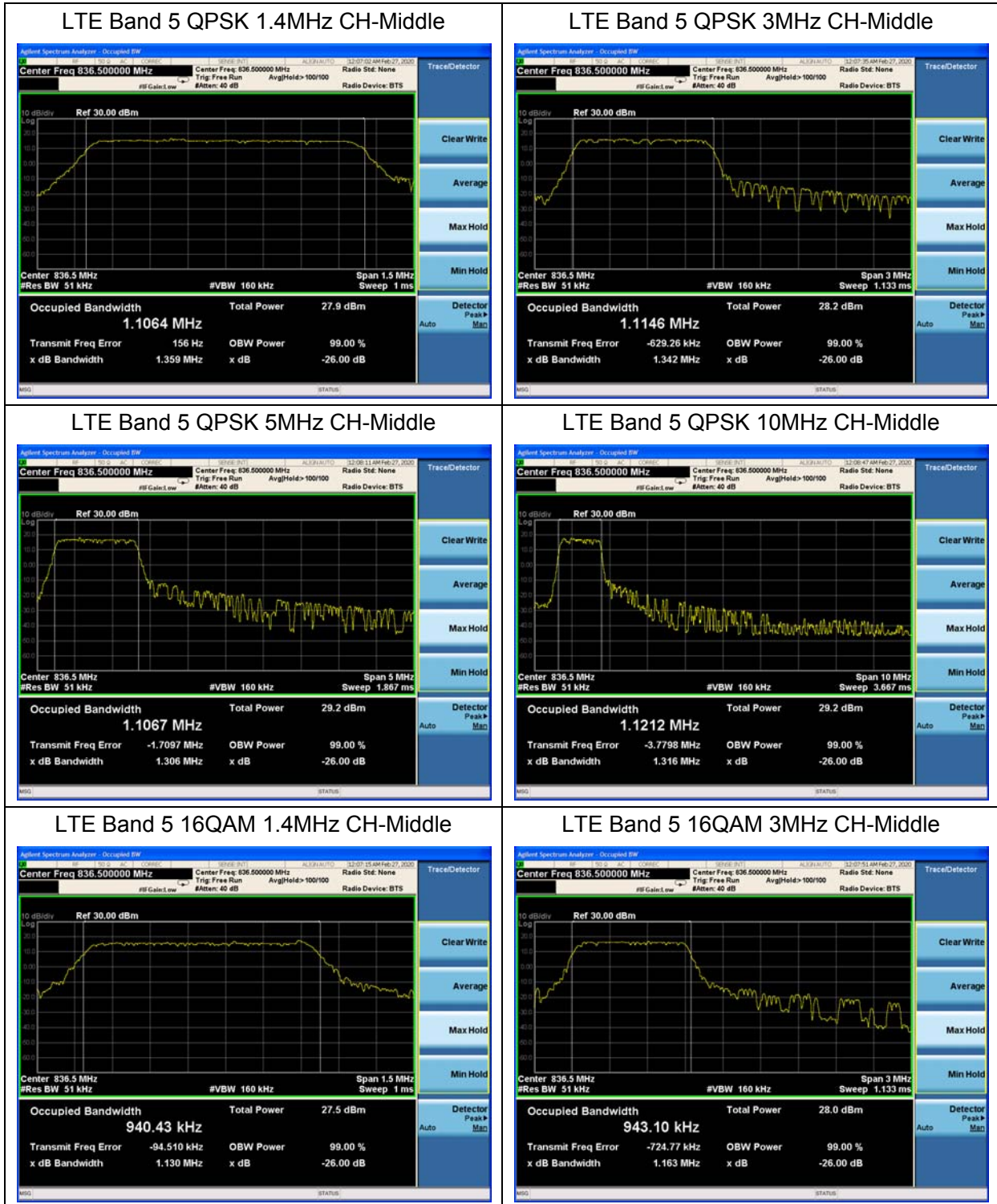

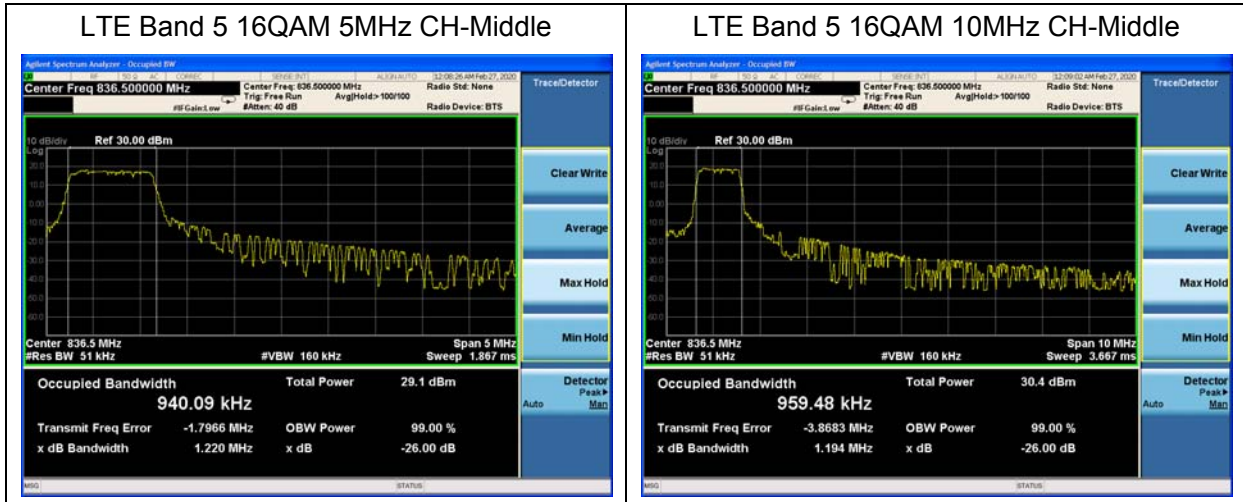

5.3. Band Edge Compliance

Ambient condition

Temperature	Relative humidity	Pressure
23°C ~25°C	45%~50%	101.5kPa

Method of Measurement

The EUT was connected to Spectrum Analyzer and Base Station Simulator via power Splitter. The band edge of the lowest and highest channels were measured. The average detector is used. RBW is set to 3kHz,VBW is set to 10kHz for GSM 850, RBW is set to 51kHz, VBW is set to 160kHz for LTE Band 5. Spectrum analyzer plots are included on the following pages.

Test Setup

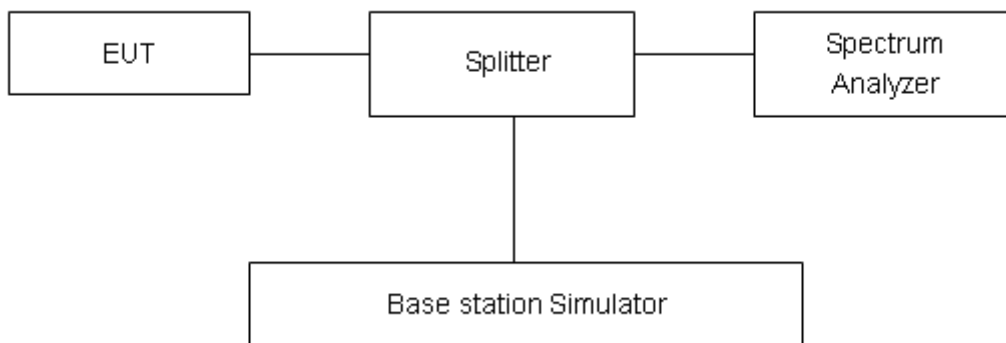

Limits

Rule Part 22.917(a) specifies that “The power of any emission outside of the authorized operating frequency ranges must be attenuated below the transmitting power (P) by a factor of at least 43 + 10 log(P) dB.”

Limit	-13 dBm
-------	---------

Measurement Uncertainty

The assessed measurement uncertainty to ensure 95% confidence level for the normal distribution is with the coverage factor $k = 1.96$, $U=0.684$ dB.



Test Result:

Original:

LTE Band 5 QPSK 1.4MHz CH-Low 1RB

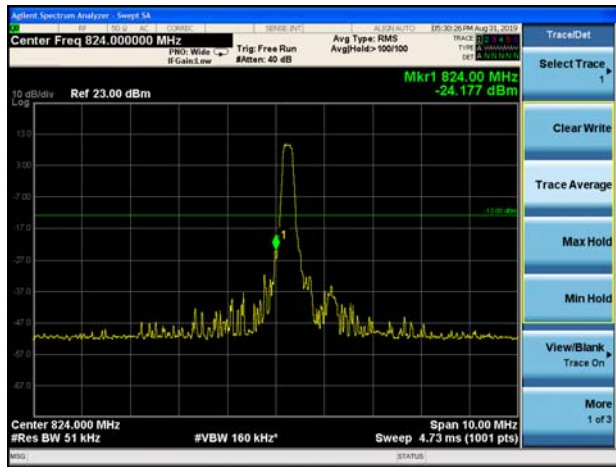

LTE Band 5 QPSK 1.4MHz CH-High 1RB

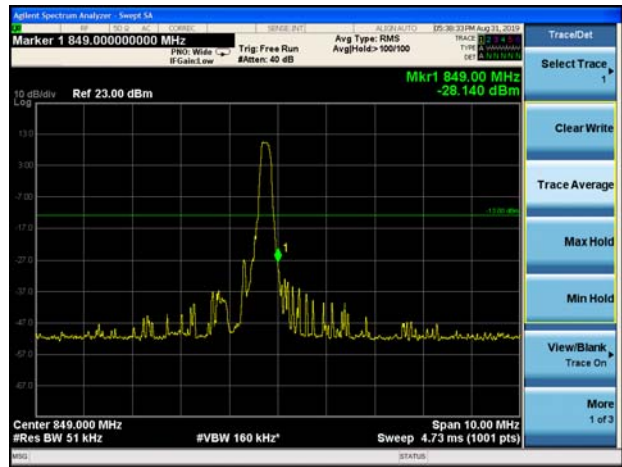

LTE Band 5 QPSK 1.4MHz CH-Low 100%RB



LTE Band 5 QPSK 1.4MHz CH-High 100%RB

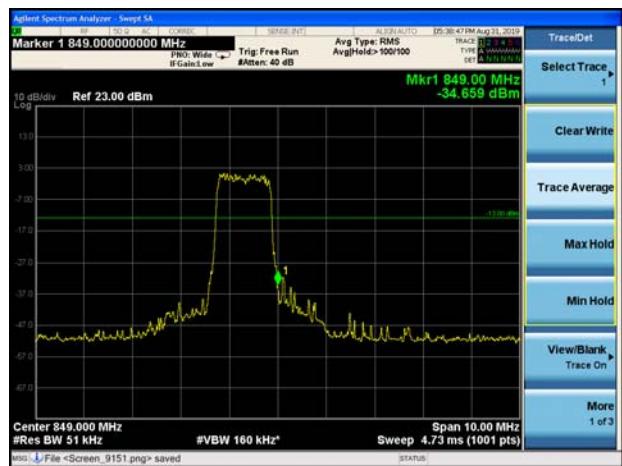

LTE Band 5 QPSK 3MHz CH-Low 1RB

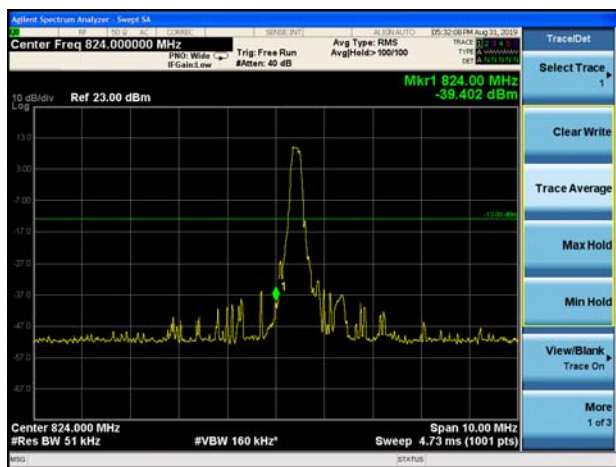

LTE Band 5 QPSK 3MHz CH-High 1RB

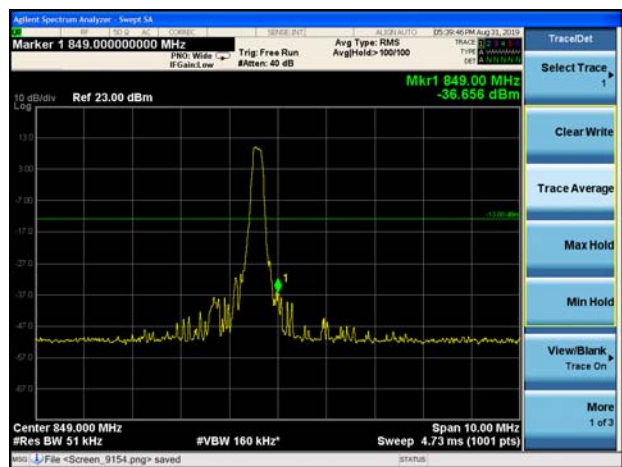



LTE Band 5 QPSK 3MHz CH-Low 100%RB

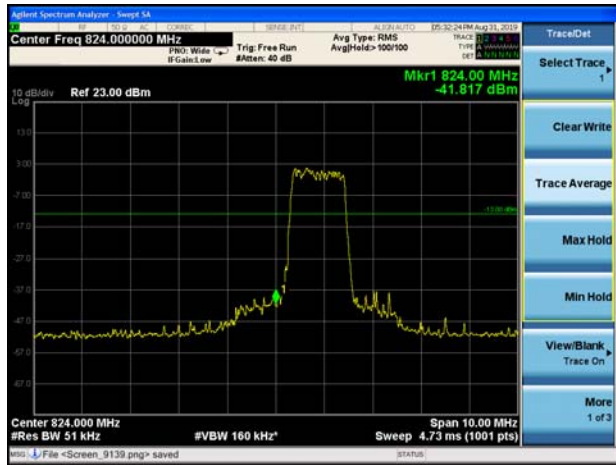

LTE Band 5 QPSK 3MHz CH-High 100%RB

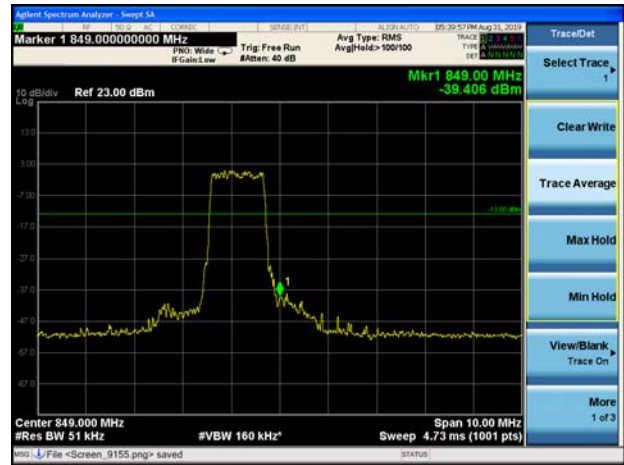

LTE Band 5 QPSK 5MHz CH-Low 1RB

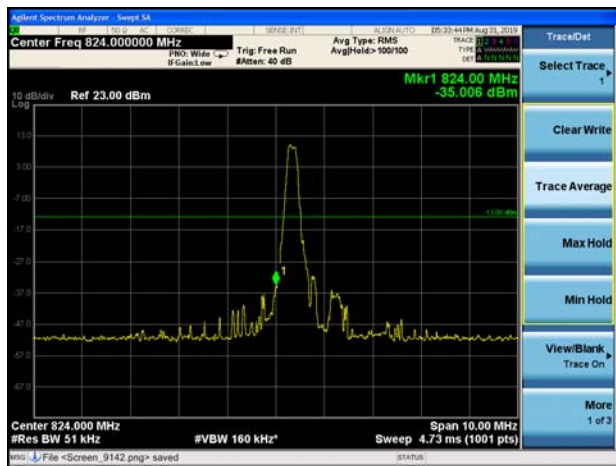

LTE Band 5 QPSK 5MHz CH-High 1RB

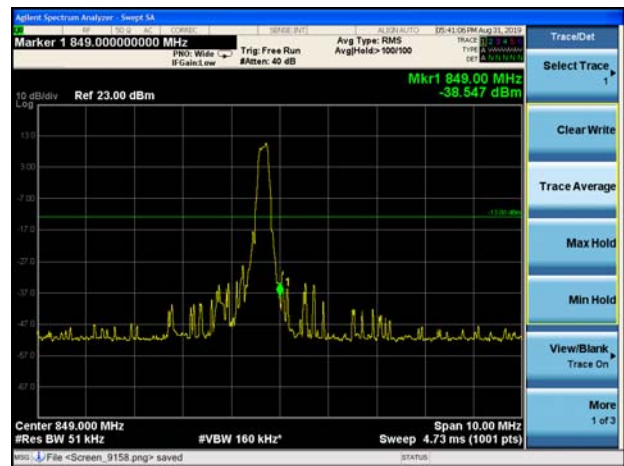

LTE Band 5 QPSK 5MHz CH-Low 100%RB

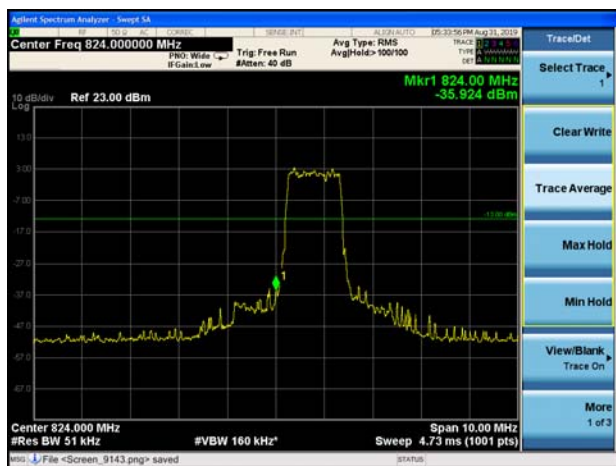

LTE Band 5 QPSK 5MHz CH-High 100%RB

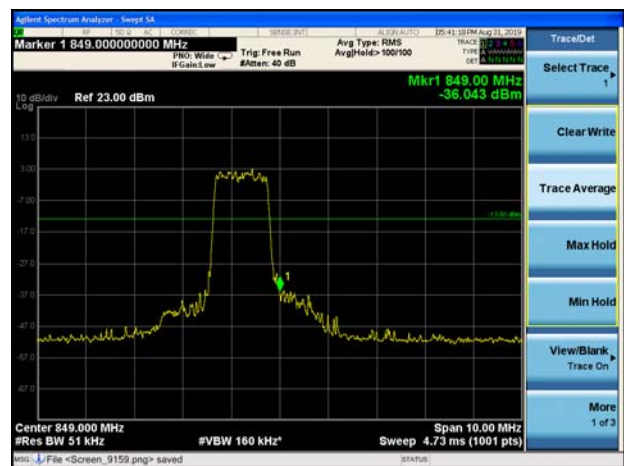

LTE Band 5 QPSK 10MHz CH-Low 1RB

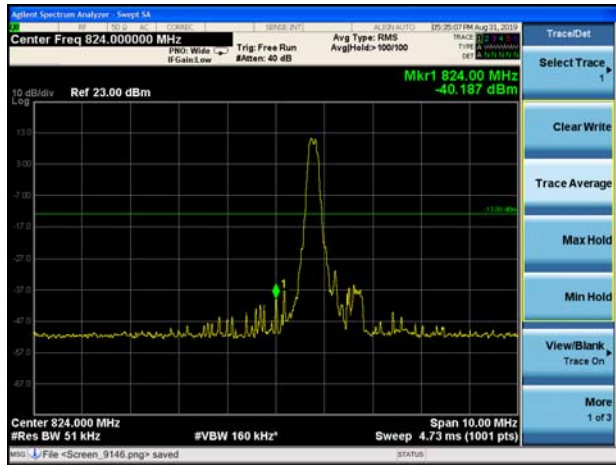

LTE Band 5 QPSK 10MHz CH-High 1RB

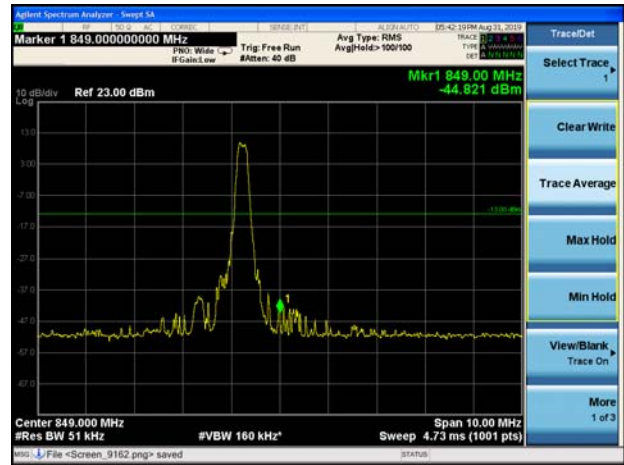

LTE Band 5 QPSK 10MHz CH-Low 100%RB

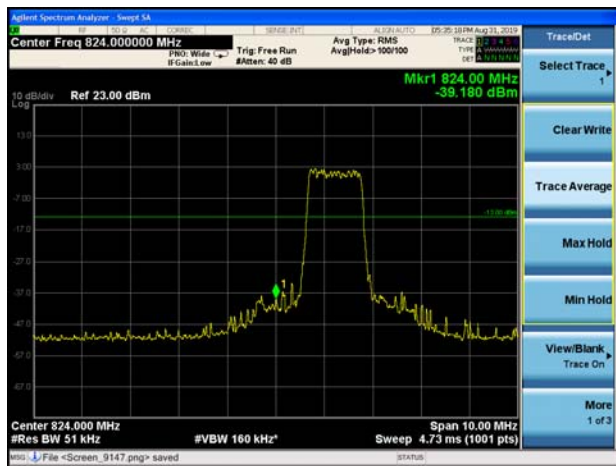

LTE Band 5 QPSK 10MHz CH-High 100%RB



LTE Band 5 16QAM 1.4MHz CH-Low 1RB



LTE Band 5 16QAM 1.4MHz CH-High 1RB

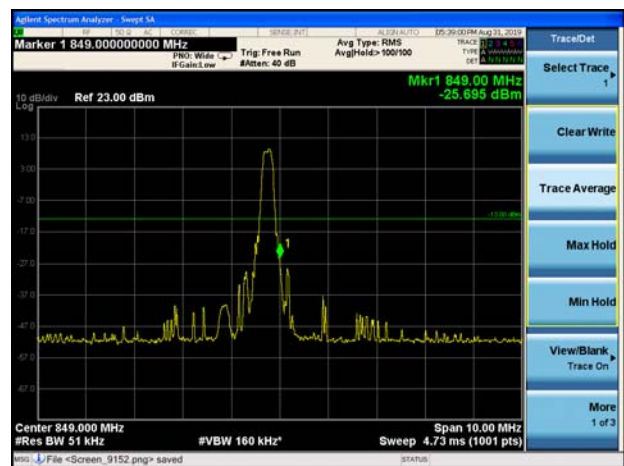

LTE Band 5 16QAM 1.4MHz CH-Low 100%RB

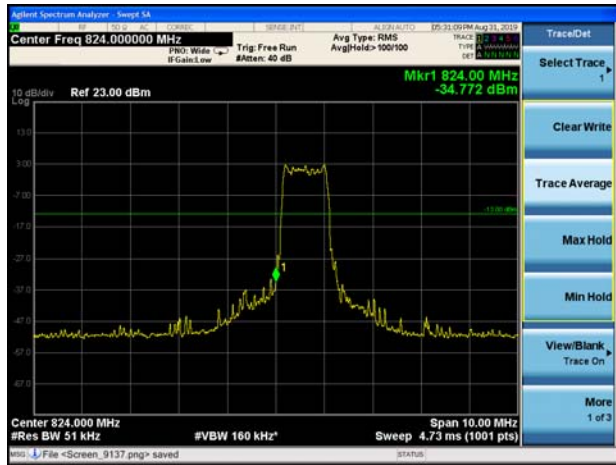

LTE Band 5 16QAM 1.4MHz CH-High 100%RB

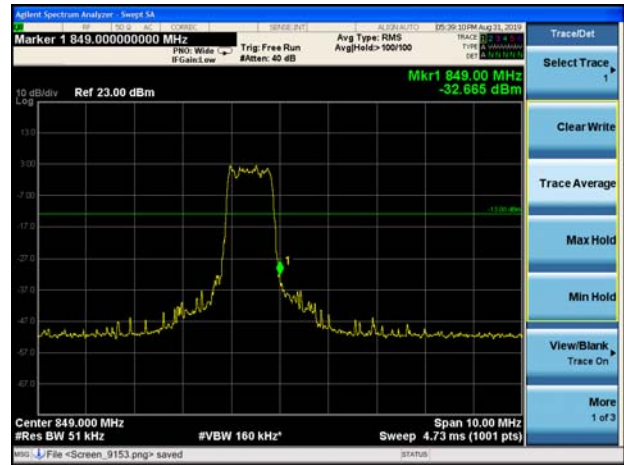

LTE Band 5 16QAM 3MHz CH-Low 1RB

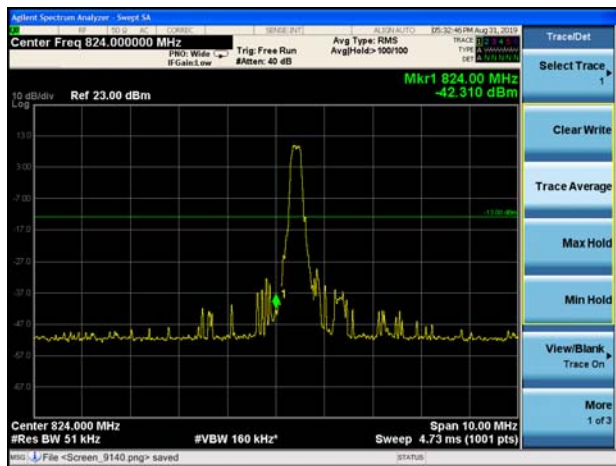

LTE Band 5 16QAM 3MHz CH-High 1RB

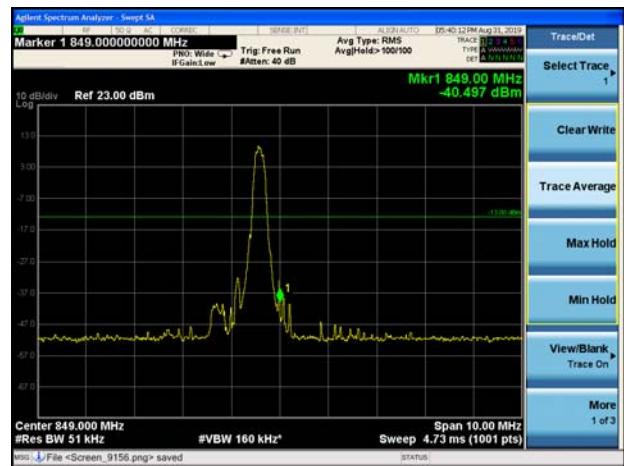

LTE Band 5 16QAM 3MHz CH-Low 100%RB

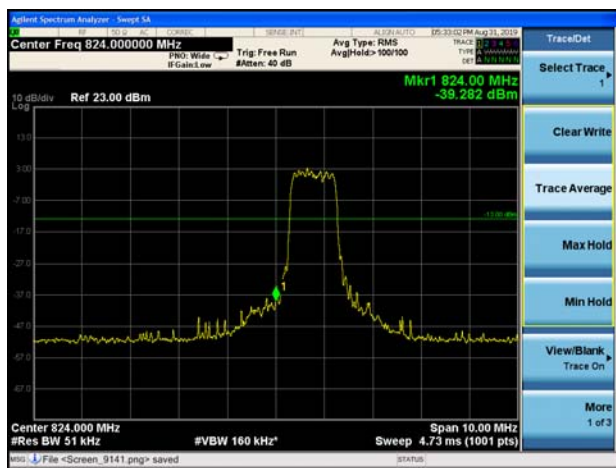

LTE Band 5 16QAM 3MHz CH-High 100%RB

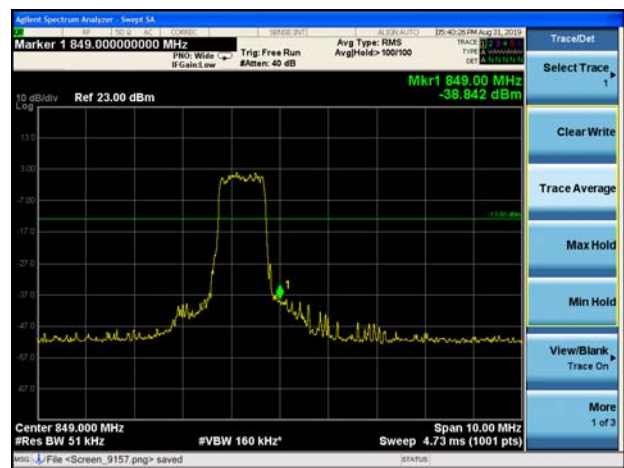



LTE Band 5 16QAM 5MHz CH-Low 1RB

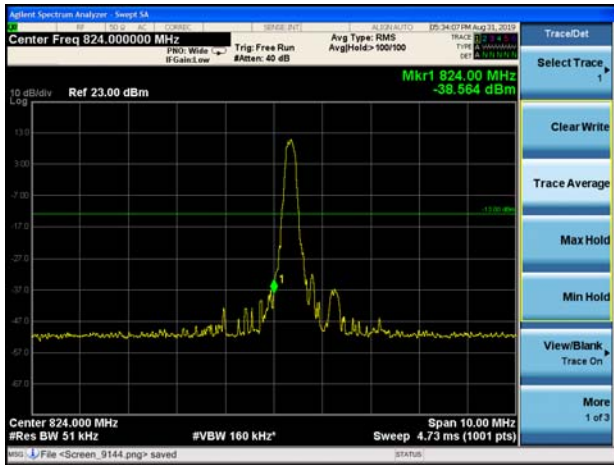

LTE Band 5 16QAM 5MHz CH-High 1RB

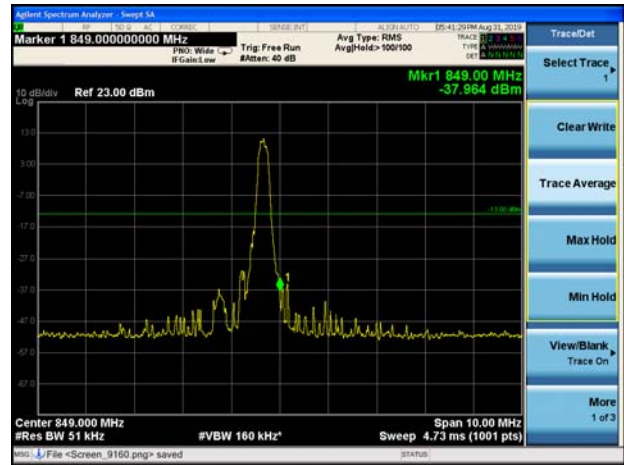

LTE Band 5 16QAM 5MHz CH-Low 100%RB

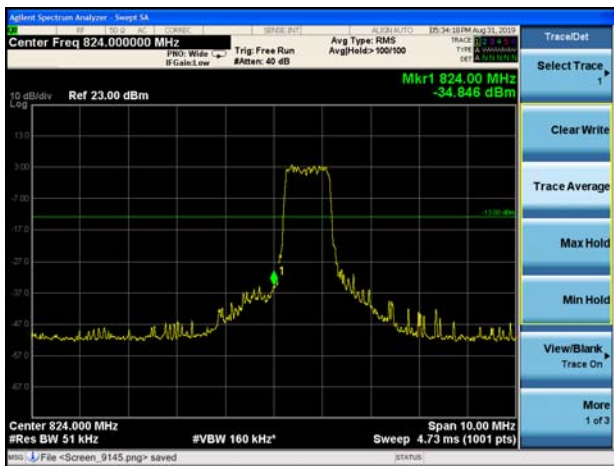

LTE Band 5 16QAM 5MHz CH-High 100%RB

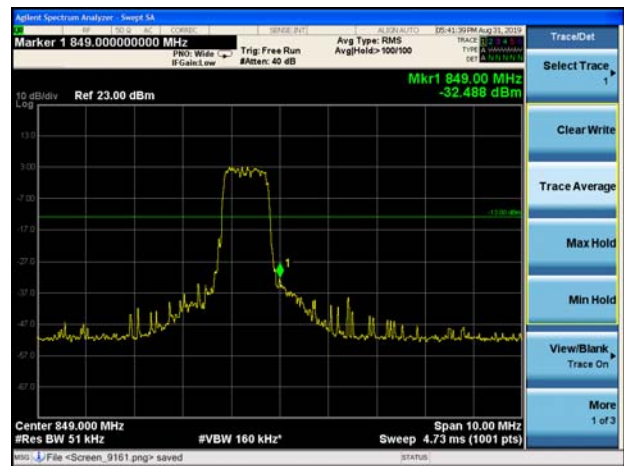

LTE Band 5 16QAM 10MHz CH-Low 1RB

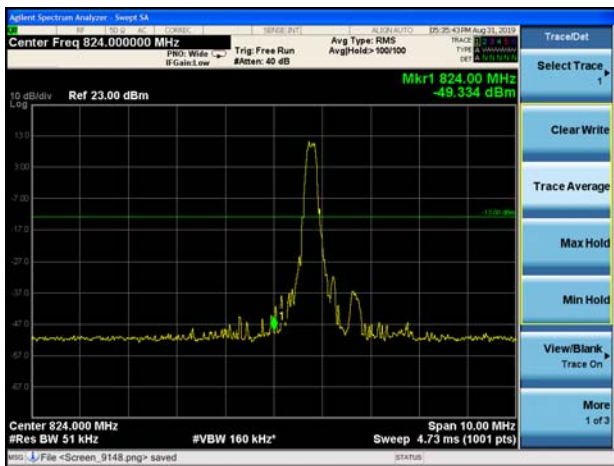

LTE Band 5 16QAM 10MHz CH-High 1RB

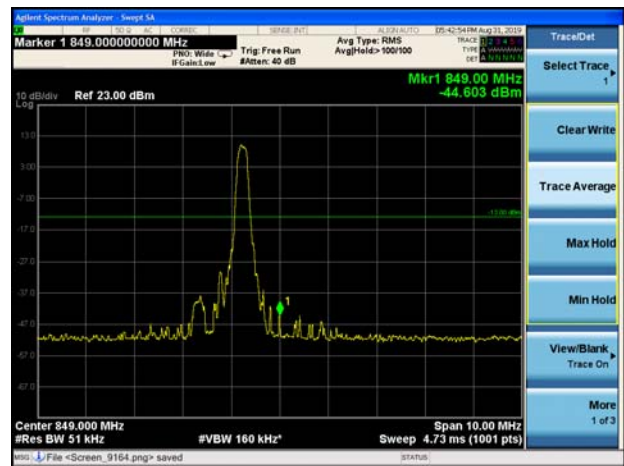



LTE Band 5 16QAM 10MHz CH-Low 100%RB

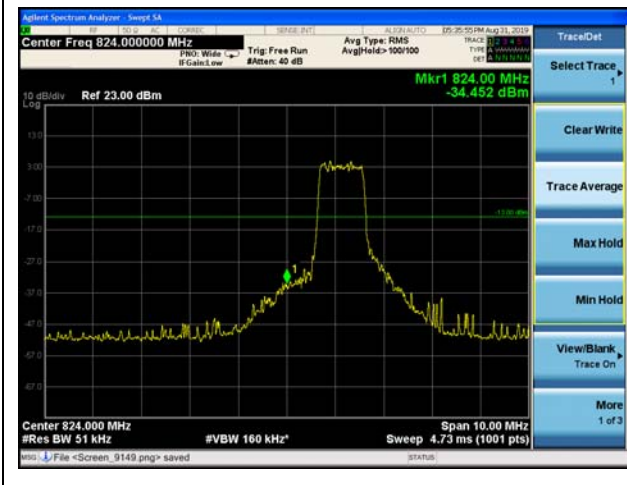

LTE Band 5 16QAM 10MHz CH-High 100%RB

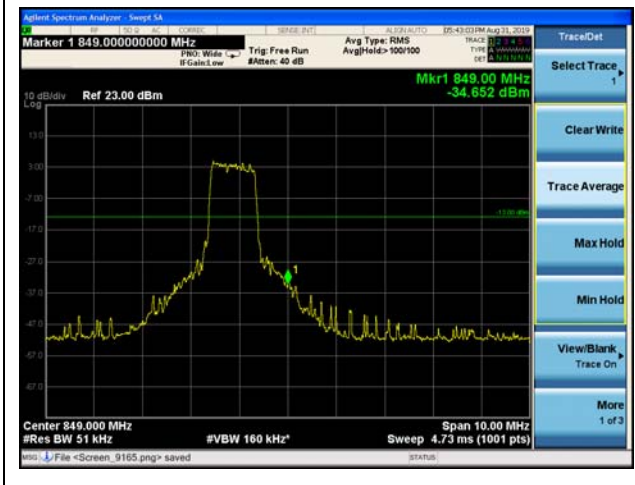

5.4. Peak-to-Average Power Ratio (PAPR)

Ambient condition

Temperature	Relative humidity	Pressure
23°C ~25°C	45%~50%	101.5kPa

Methods of Measurement

Measure the total peak power and record as P_{Pk} . And measure the total average power and record as P_{Avg} . Both the peak and average power levels must be expressed in the same logarithmic units (e.g., dBm). Determine the PAPR from:

$$PAPR (dB) = P_{Pk} (dBm) - P_{Avg} (dBm).$$

Test Setup

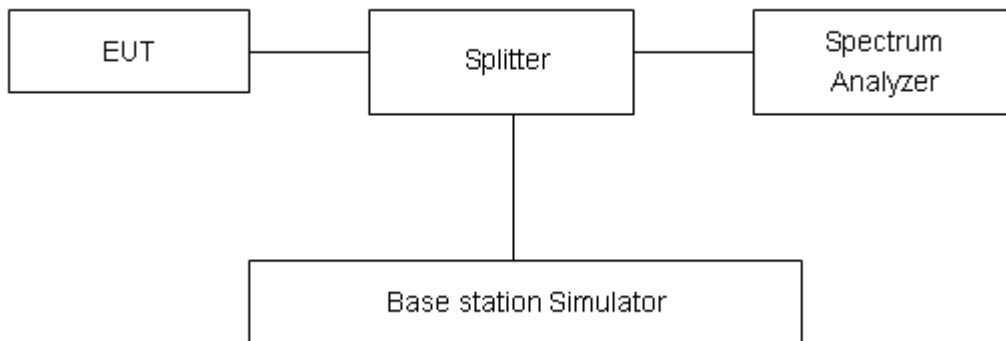

Limits

According to the Sec. 22.913(d), The peak-to-average ratio (PAR) of the transmission must not exceed 13 dB.

Measurement Uncertainty

The assessed measurement uncertainty to ensure 95% confidence level for the normal distribution is with the coverage factor $k = 2$, $U = 0.4$ dB.

**Test Results****Original:**

Mode	Bandwidth	Modulation	Channel/ Frequency(MHz)	Peak-to-Average Power Ratio (PAPR)		
				Peak(dBm)	Avg(dBm)	PAPR(dB)
Band5	1.4MHz	QPSK	20525/836.5	24.49	13.46	11.03
		16QAM	20525/836.5	25.48	14.48	11.00
	3MHz	QPSK	20525/836.5	24.39	13.31	11.08
		16QAM	20525/836.5	25.18	13.68	11.50
	5MHz	QPSK	20525/836.5	24.96	15.84	9.12
		16QAM	20525/836.5	25.37	15.61	9.76
	10MHz	QPSK	20525/836.5	24.87	16.16	8.71
		16QAM	20525/836.5	25.67	16.96	8.71

5.5. Frequency Stability

Ambient condition

Temperature	Relative humidity	Pressure
23°C ~25°C	45%~50%	101.5kPa

Method of Measurement

Frequency Stability (Temperature Variation)

The temperature inside the climate chamber is varied from -40°C to +85°C in 10°C step size,

(1) With all power removed, the temperature was decreased to 0°C and permitted to stabilize for three hours.

(2) Measure the carrier frequency with the test equipment in a “call mode”. These measurements should be made within 1 minute of powering up the mobile station, to prevent significant self warming.

(3) Repeat the above measurements at 10°C increments from -40°C to +85°. Allow at least 1.5 hours at each temperature, un-powered, before making measurements.

Frequency Stability (Voltage Variation)

The frequency stability shall be measured with variation of primary supply voltage as follows:

(1) Vary primary supply voltage from 85 to 115 percent of the nominal value for other than hand carried battery equipment.

(2) For hand carried, battery powered equipment, reduce primary supply voltage to the battery-operating end point which shall be specified by the manufacturer.

This transceiver is specified to operate with an input voltage of between 2.6 V and 4.8 V, with a nominal voltage of 3.3V.

Test setup

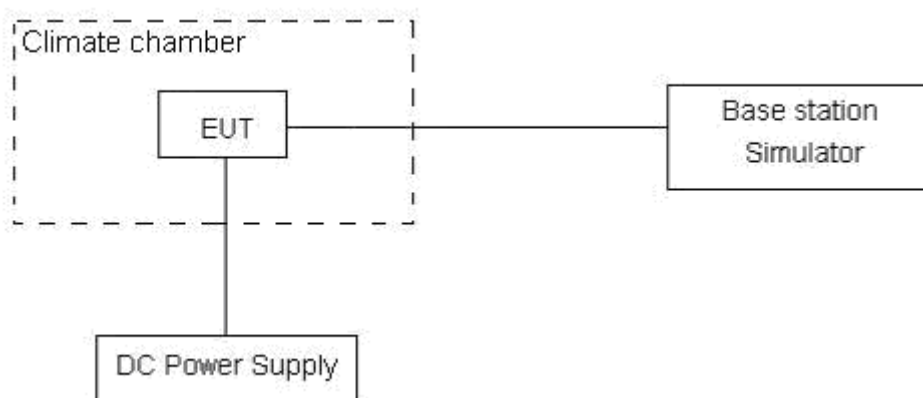

**Limits**

According to the Sec. 22.355, the frequency stability of the carrier shall be accurate to within 2.5 ppm of the received frequency for mobile stations.

Limits	≤ 2.5 ppm
--------	----------------

Measurement Uncertainty

The assessed measurement uncertainty to ensure 99.75% confidence level for the normal distribution is with the coverage factor $k = 3$, $U = 0.01$ ppm.

Test Result

Original:

LTE Band 5						
Condition		Freq.Error (Hz)	Freq.Error (Hz)	Frequency Stability (ppm)	Frequency Stability (ppm)	Verdict
BANDWIDTH	10MHz					
Temperature	Voltage	16QAM	QPSK	16QAM	QPSK	
Normal (25°C)	Normal	1.91	2.89	0.00102	0.00154	PASS
Extreme (85°C)		12.53	10.39	0.00666	0.00553	PASS
Extreme (80°C)		16.33	11.46	0.00869	0.00610	PASS
Extreme (70°C)		15.22	9.98	0.00809	0.00531	PASS
Extreme (60°C)		8.19	17.12	0.00436	0.00911	PASS
Extreme (50°C)		5.63	15.52	0.00299	0.00825	PASS
Extreme (40°C)		16.17	14.22	0.00860	0.00757	PASS
Extreme (30°C)		6.04	2.41	0.00321	0.00128	PASS
Extreme (20°C)		4.84	15.78	0.00258	0.00839	PASS
Extreme (10°C)		7.97	13.45	0.00424	0.00715	PASS
Extreme (0°C)		17.66	9.05	0.00939	0.00481	PASS
Extreme (-10°C)		10.41	11.71	0.00554	0.00623	PASS
Extreme (-20°C)		10.46	17.92	0.00556	0.00953	PASS
Extreme (-30°C)		11.51	8.42	0.00612	0.00448	PASS
Extreme (-40°C)		10.34	12.60	0.00550	0.00670	PASS
25°C		LV	16.26	6.70	0.00865	0.00356
	HV	14.02	3.73	0.00746	0.00198	PASS

5.6. Spurious Emissions at Antenna Terminals

Ambient condition

Temperature	Relative humidity	Pressure
23°C ~25°C	45%~50%	101.5kPa

Method of Measurement

The EUT was connected to Spectrum Analyzer and Base Station Simulator via power Splitter. The measurement is carried out using a spectrum analyzer. The spectrum analyzer scans from 9kHz to the 10th harmonic of the carrier.

The peak detector is used. RBW are set to 100 kHz and VBW are set to 300 kHz for below 1G, RBW are set to 1MHz and VBW are set to 3MHz for above 1G, Sweep is set to ATUO.

The modulation mode and RB allocation refer to section 5.1, using the maximum output power configuration.

Test setup

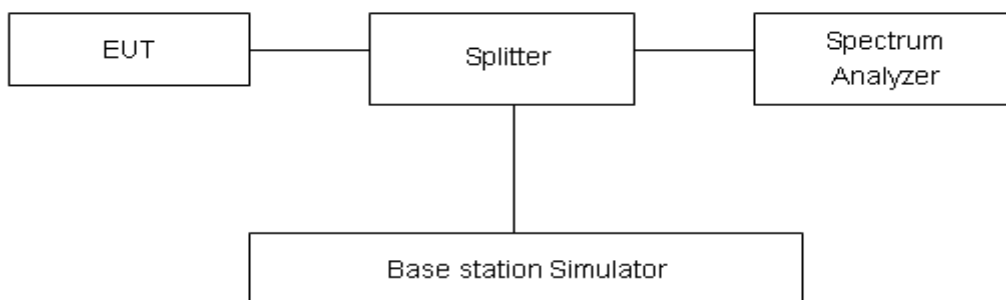

Limits

Rule Part 22.917(a) specifies that “The power of any emission outside of the authorized operating frequency ranges must be attenuated below the transmitting power (P) by a factor of at least 43 + 10 log (P) dB.”

Limit	-13 dBm
-------	---------

Measurement Uncertainty

The assessed measurement uncertainty to ensure 99.75% confidence level for the normal distribution is with the coverage factor $k = 1.96$.

Frequency	Uncertainty
9kHz-1GHz	0.684 dB
1GHz-18GHz	1.407 dB



Test Result

Sweep the whole frequency band through the range from 9kHz to the 10th harmonic of the carrier, the emissions more than 20 dB below the limit are not reported.

The signal beyond the limit is carrier.

Original:

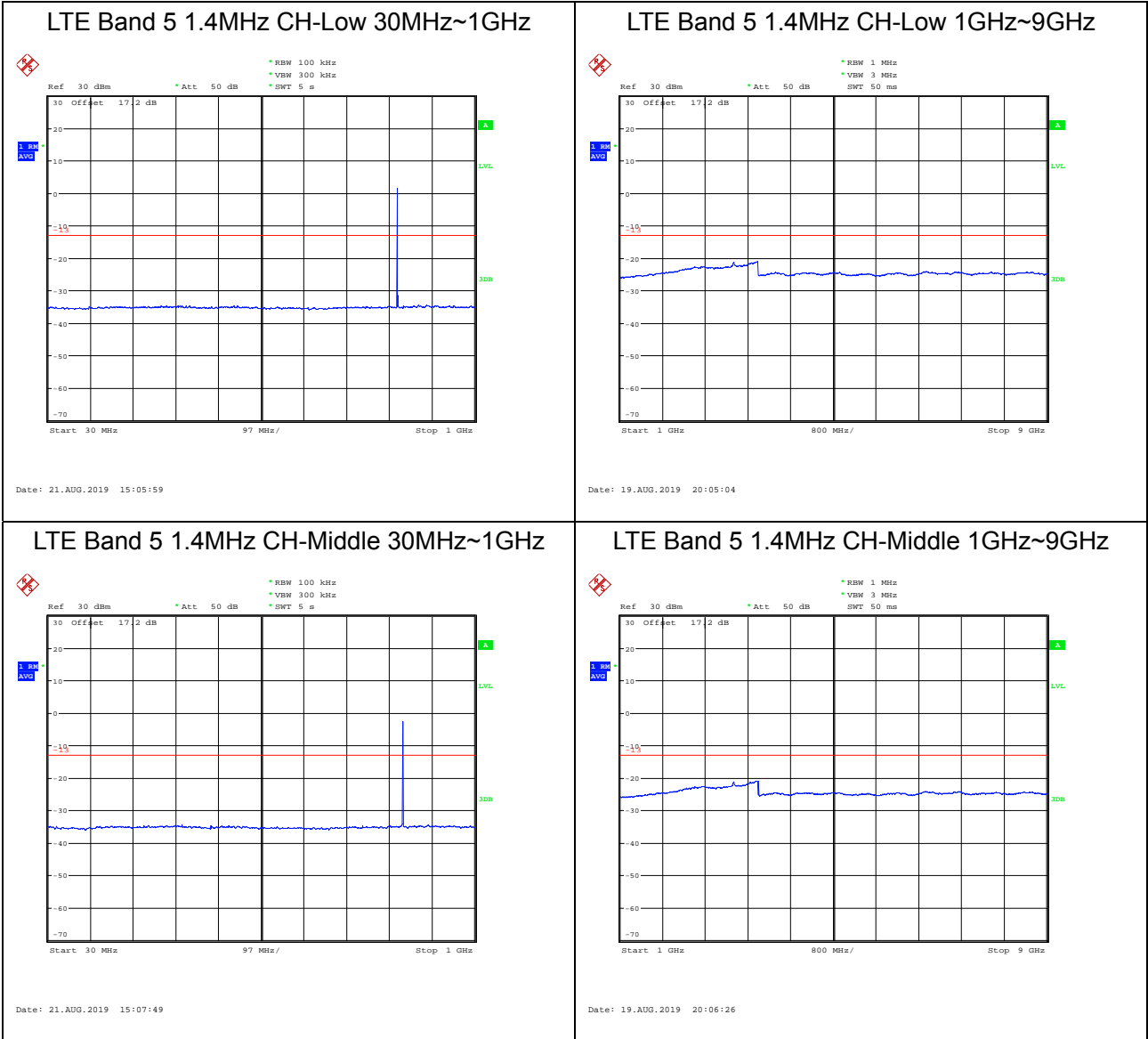



LTE Band 5 1.4MHz CH-High 30MHz~1GHz

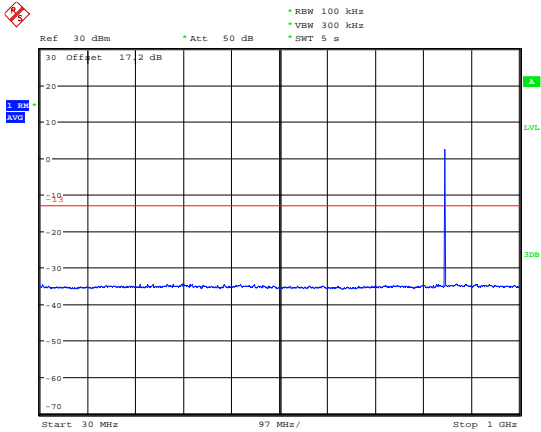

Date: 21.AUG.2019 15:09:07

LTE Band 5 1.4MHz CH-High 1GHz~9GHz

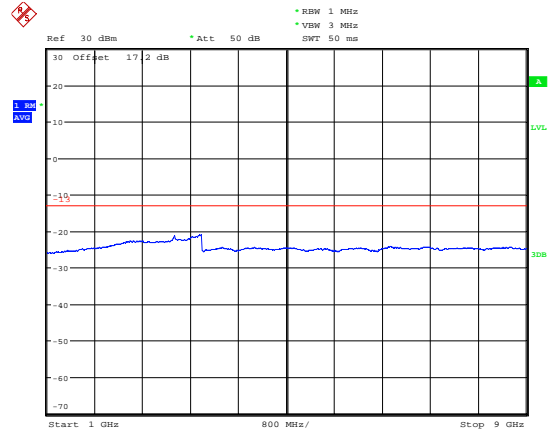

Date: 19.AUG.2019 20:07:34

LTE Band 5 3MHz CH-Low 30MHz~1GHz

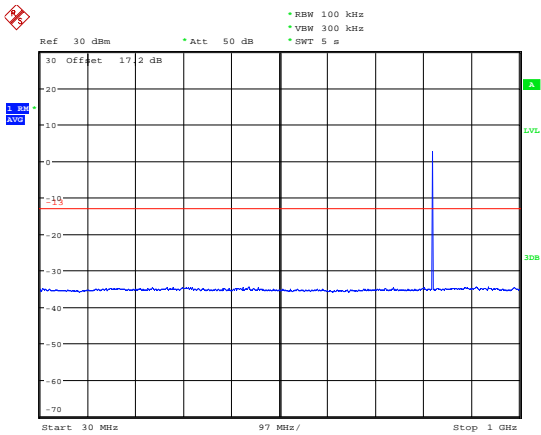

Date: 21.AUG.2019 15:10:45

LTE Band 5 3MHz CH-Low 1GHz~9GHz

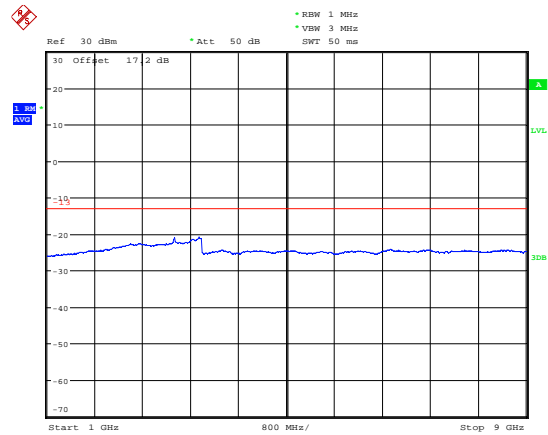

Date: 19.AUG.2019 20:08:03

LTE Band 5 3MHz CH-Middle 30MHz~1GHz

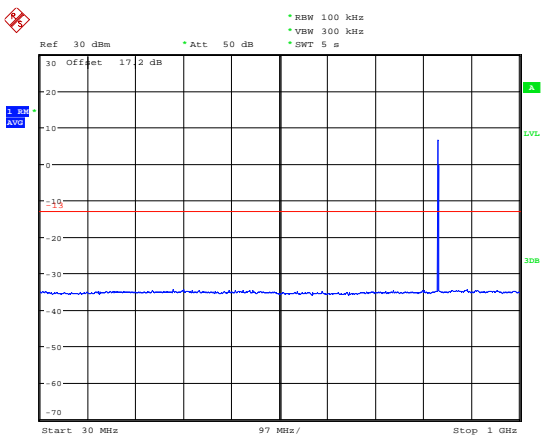

Date: 21.AUG.2019 15:12:36

LTE Band 5 3MHz CH-Middle 1GHz~9GHz

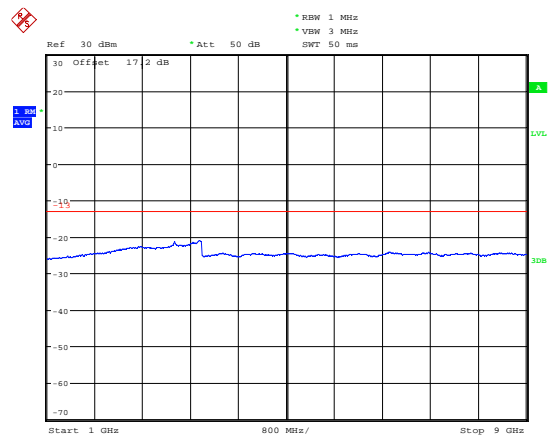

Date: 19.AUG.2019 20:08:26



LTE Band 5 3MHz CH-High 30MHz~1GHz

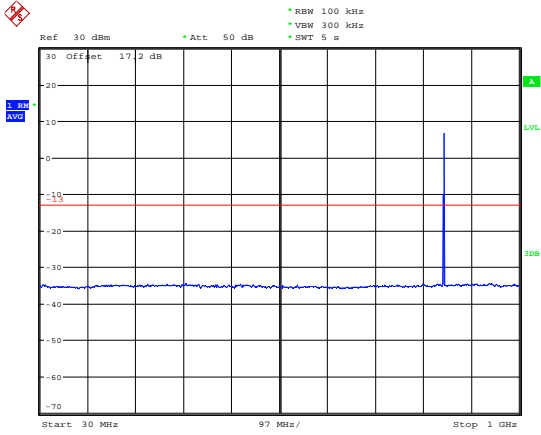

Date: 21.AUG.2019 15:14:39

LTE Band 5 3MHz CH-High 1GHz~9GHz

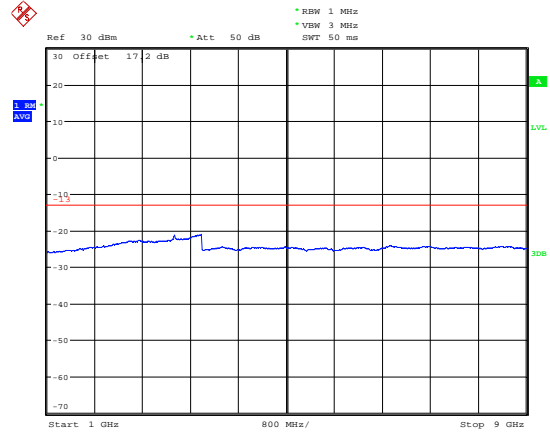

Date: 19.AUG.2019 20:09:10

LTE Band 5 5MHz CH-Low 30MHz~1GHz

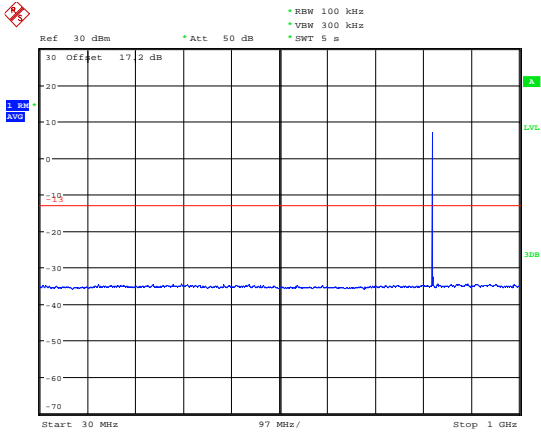

Date: 21.AUG.2019 15:17:07

LTE Band 5 5MHz CH-Low 1GHz~9GHz

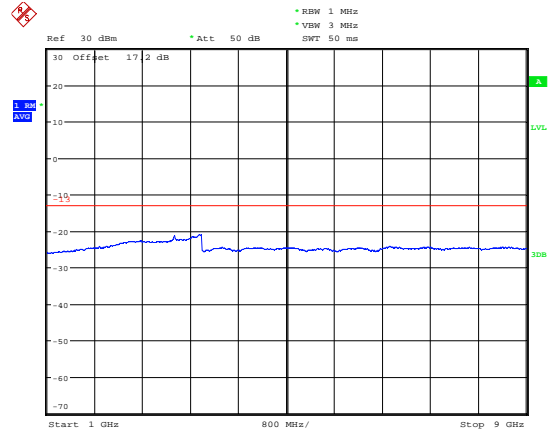

Date: 19.AUG.2019 20:09:19

LTE Band 5 5MHz CH-Middle 30MHz~1GHz

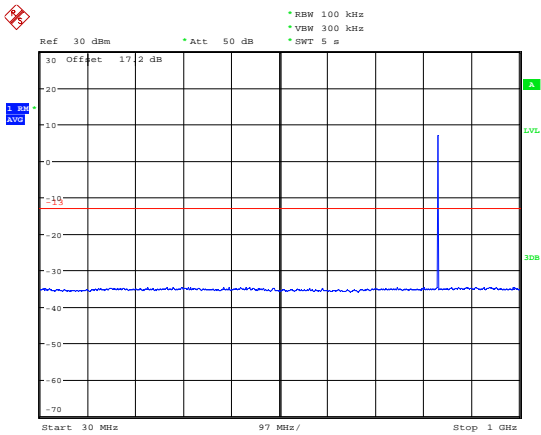

Date: 21.AUG.2019 15:18:05

LTE Band 5 5MHz CH-Middle 1GHz~9GHz

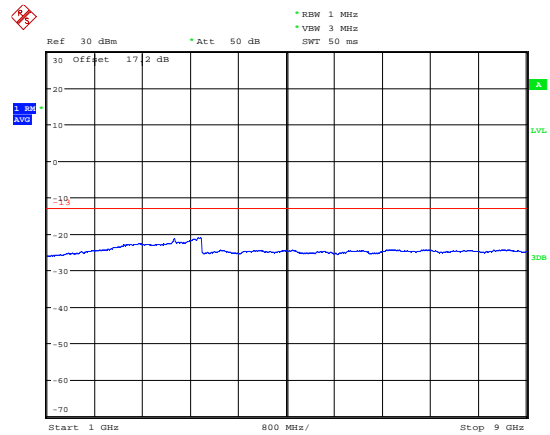

Date: 19.AUG.2019 20:09:31



LTE Band 5 5MHz CH-High 30MHz~1GHz

LTE Band 5 5MHz CH-High 1GHz~9GHz

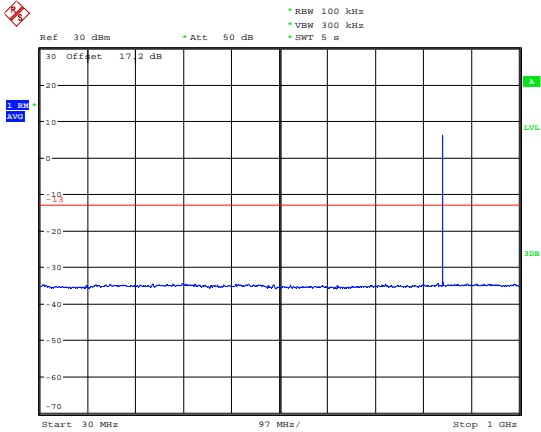

Date: 21.AUG.2019 15:20:11

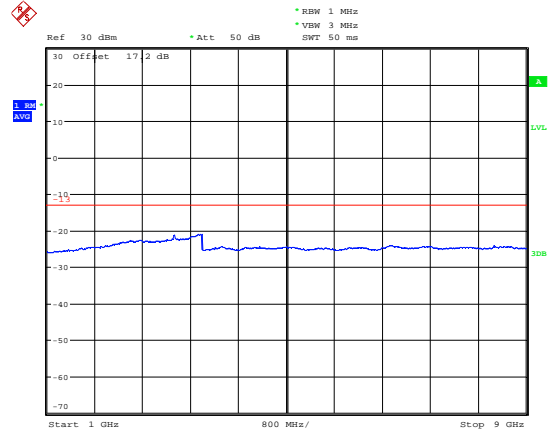

Date: 19.AUG.2019 20:09:42



LTE Band 5 10MHz CH-Low 30MHz~1GHz

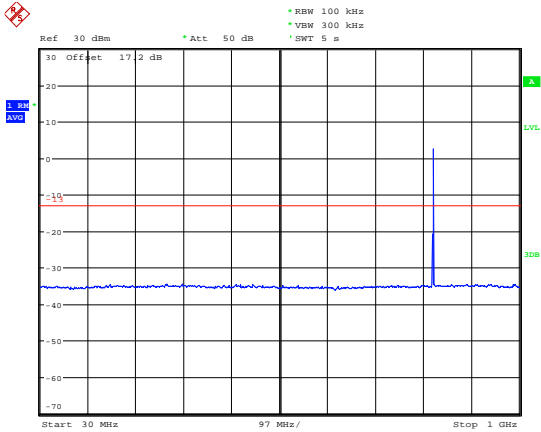

Date: 21.AUG.2019 13:28:50

LTE Band 5 10MHz CH-Low 1GHz~9GHz

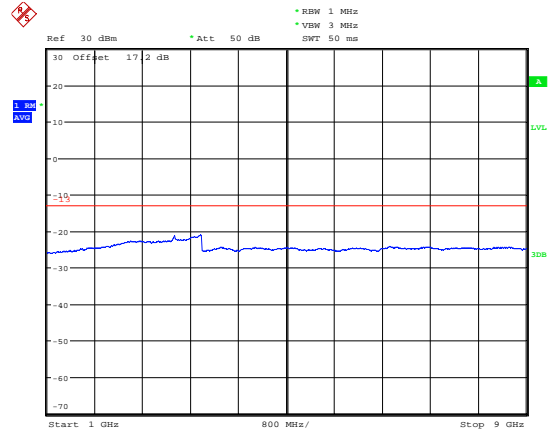

Date: 19.AUG.2019 20:09:58

LTE Band 5 10MHz CH-Middle 30MHz~1GHz

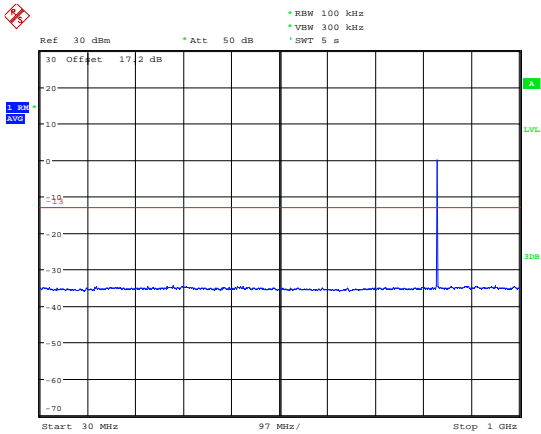

Date: 21.AUG.2019 13:30:13

LTE Band 5 10MHz CH-Middle 1GHz~9GHz

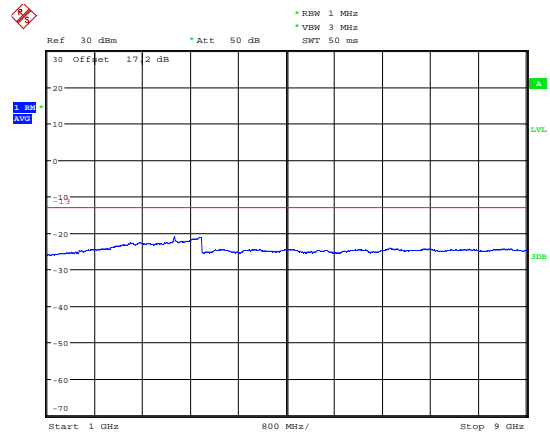

Date: 19.AUG.2019 20:10:16

LTE Band 5 10MHz CH-High 30MHz~1GHz

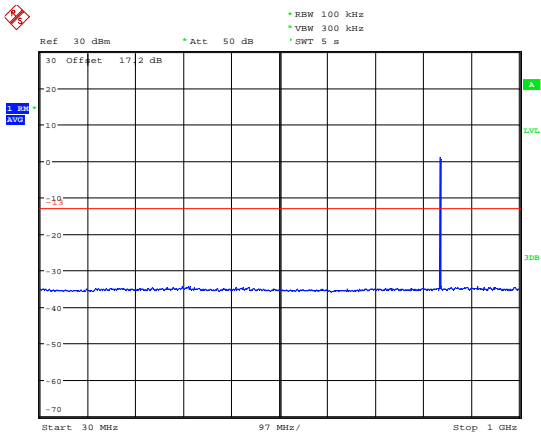

Date: 21.AUG.2019 13:31:31

LTE Band 5 10MHz CH-High 1GHz~9GHz

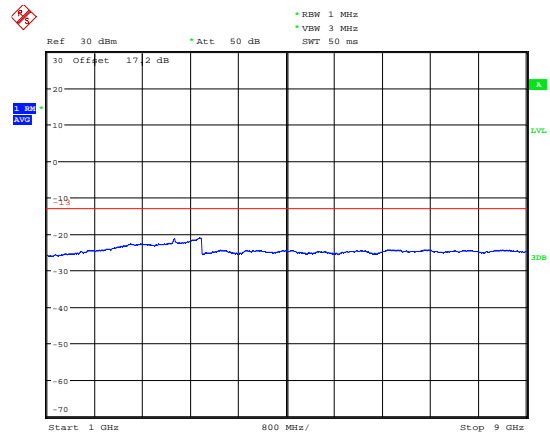

Date: 19.AUG.2019 20:10:31

5.7. Radiates Spurious Emission

Ambient condition

Temperature	Relative humidity	Pressure
23°C ~25°C	45%~50%	101.5kPa

Method of Measurement

1. The testing follows FCC KDB 971168 v03r01 Section 5.8 and ANSI C63.26 (2015).
2. Below 1GHz: The EUT is placed on a turntable 0.8 meters above the ground in the chamber, 3 meter away from the antenna. The maximal emission value is acquired by adjusting the antenna height, polarisation and turntable azimuth. Normally, the height range of antenna is 1 m to 4 m, the azimuth range of turntable is 0° to 360°, and the receive antenna has two polarizations Vertical (V) and Horizontal (H). Above 1GHz: (Note: the FCC's permission to use 1.5m as an alternative per TCBC Conf call of Dec. 2, 2014.) The EUT is placed on a turntable 1.5 meters above the ground in the chamber, 3 meter away from the antenna. The maximal emission value is acquired by adjusting the antenna height, polarisation and turntable azimuth. Normally, the height range of antenna is 1 m to 4 m, the azimuth range of turntable is 0° to 360°, and the receive antenna has two polarizations Vertical (V) and Horizontal (H).
3. A loop antenna, A log-periodic antenna or horn antenna shall be substituted in place of the EUT. The log-periodic antenna will be driven by a signal generator and the level will be adjusted till the same power value on the spectrum analyzer or receiver. The level of the spurious emissions can be calculated through the level of the signal generator, cable loss, the gain of the substitution antenna and the reading of the spectrum analyzer or receiver.
4. The EUT is then put into continuously transmitting mode at its maximum power level during the test. Set Test Receiver or Spectrum RBW=200Hz,VBW=600Hz for 9kHz150kHz , RBW=10kHz, VBW=30kHz 150kHz-30MHz , RBW=100kHz,VBW=300kHz for 30MHz to 1GHz and RBW=1MHz, VBW=3MHz for above 1GHz, And the maximum value of the receiver should be recorded as (Pr).
5. The EUT shall be replaced by a substitution antenna. In the chamber, an substitution antenna for the frequency band of interest is placed at the reference point of the chamber. An RF Signal source for the frequency band of interest is connected to the substitution antenna with a cable that has been constructed to not interfere with the radiation pattern of the antenna. A power (PMea) is applied to the input of the substitution antenna, and adjust the level of the signal generator output until the value of the receiver reach the previously recorded (Pr). The power of signal source (PMea) is recorded. The test should be performed by rotating the test item and adjusting the receiving antenna polarization.
6. A amplifier should be connected to the Signal Source output port. And the cable should be connect between the Amplifier and the Substitution Antenna. The cable loss (Pcl) ,the Substitution Antenna Gain (Ga) and the Amplifier Gain (PAg) should be recorded after test.
7. The measurement results are obtained as described below:
Power(EIRP)=PMea- PAg - Pcl + Ga
The measurement results are amend as described below:
Power(EIRP)=PMea- Pcl + Ga
8. This value is EIRP since the measurement is calibrated using an antenna of known gain (2.15 dBi)

and known input power. ERP can be calculated from EIRP by subtracting the gain of the dipole, $ERP = EIRP - 2.15\text{dBi}$.

The modulation mode and RB allocation refer to section 5.1, using the maximum output power configuration.

Test setup

9KHz ~ 30MHz

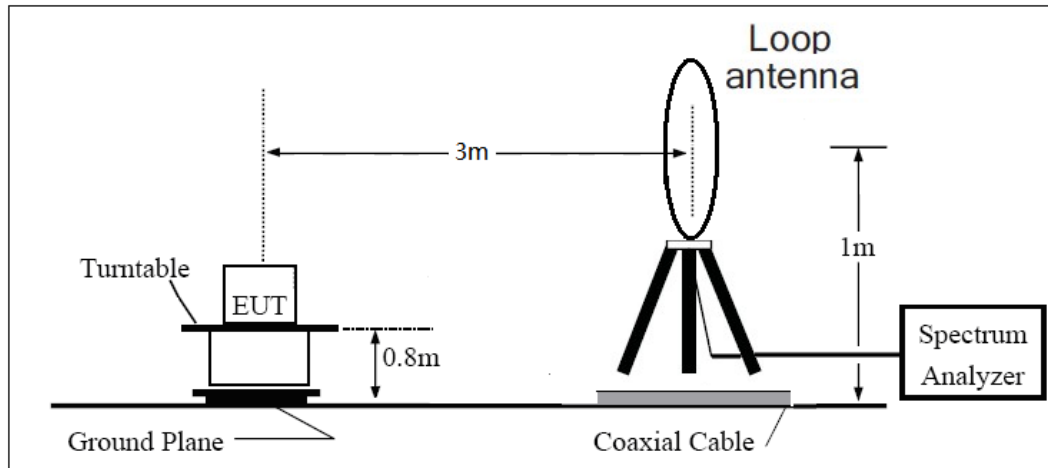

30MHz ~ 1GHz

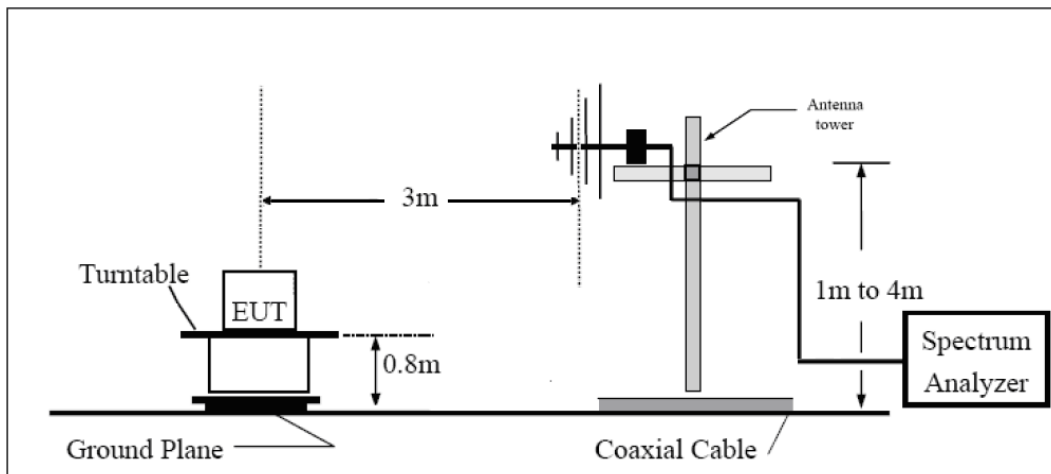

Above 1GHz

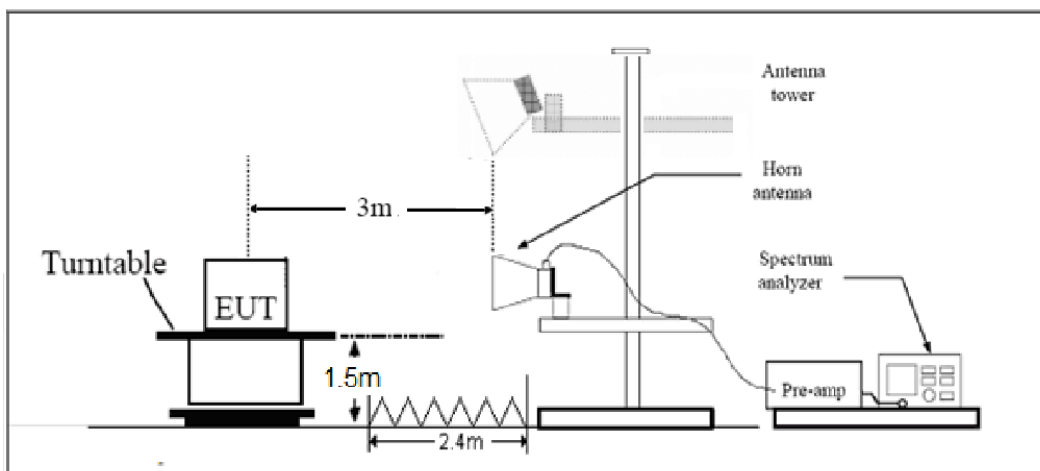



Note: Area side:2.4mX3.6m

Limits

Rule Part 22.917(a) specifies that “The power of any emission outside of the authorized operating frequency ranges must be attenuated below the transmitting power (P) by a factor of at least $43 + 10 \log (P)$ dB.”

Limit	-13 dBm
-------	---------

Measurement Uncertainty

The assessed measurement uncertainty to ensure 95% confidence level for the normal distribution is with the coverage factor $k = 1.96$, $U = 3.55$ dB.

**Test Result**

Sweep the whole frequency band through the range from 9kHz to the 10th harmonic of the carrier, the emissions below the noise floor will not be recorded in the report.

Variant:

LTE Band 5 1.4MHz CH-Middle

Harmonic	Frequency (MHz)	SG (dBm)	Cable Loss (dB)	Gain (dBi)	Antenna Polarization	ERP Level (dBm)	Limit (dBm)	Margin (dB)	Azimuth (deg)
2	1673.1	-52.03	2.00	10.75	Horizontal	-45.43	-13.00	32.43	45
3	2509.7	-41.27	2.51	11.05	Horizontal	-34.88	-13.00	21.88	315
4	3346.2	-59.64	4.20	11.15	Horizontal	-54.84	-13.00	41.84	0
5	4182.8	-56.58	5.20	11.15	Horizontal	-52.78	-13.00	39.78	180
6	5019.3	-55.22	5.50	11.95	Horizontal	-50.92	-13.00	37.92	45
7	5855.9	-57.55	5.70	13.55	Horizontal	-51.85	-13.00	38.85	0
8	6692.5	-58.13	6.30	13.75	Horizontal	-52.83	-13.00	39.83	270
9	7529.0	-55.60	6.80	13.85	Horizontal	-50.70	-13.00	37.70	135
10	8365.6	-55.61	6.90	14.25	Horizontal	-50.41	-13.00	37.41	225

Note: 1.The other Spurious RF Radiated emissions level is no more than noise floor.
2.The worst emission was found in the antenna is Horizontal position.

LTE Band 5 5MHz CH-Middle

Harmonic	Frequency (MHz)	SG (dBm)	Cable Loss (dB)	Gain (dBi)	Antenna Polarization	ERP Level (dBm)	Limit (dBm)	Margin (dB)	Azimuth (deg)
2	1673.0	-56.91	2.00	10.75	Horizontal	-50.31	-13.00	37.31	90
3	2509.5	-41.27	2.51	11.05	Horizontal	-34.88	-13.00	21.88	255
4	3337.1	-53.84	4.20	11.15	Horizontal	-49.04	-13.00	36.04	45
5	4182.5	-56.16	5.20	11.15	Horizontal	-52.36	-13.00	39.36	315
6	5019.0	-55.63	5.50	11.95	Horizontal	-51.33	-13.00	38.33	225
7	5855.5	-56.88	5.70	13.55	Horizontal	-51.18	-13.00	38.18	90
8	6692.0	-55.77	6.30	13.75	Horizontal	-50.47	-13.00	37.47	0
9	7528.5	-54.51	6.80	13.85	Horizontal	-49.61	-13.00	36.61	45
10	8365.0	-54.82	6.90	14.25	Horizontal	-49.62	-13.00	36.62	315

Note: 1.The other Spurious RF Radiated emissions level is no more than noise floor.
2.The worst emission was found in the antenna is Horizontal position.



LTE Band 5 10MHz CH-Middle

Harmonic	Frequency (MHz)	SG (dBm)	Cable Loss (dB)	Gain (dBi)	Antenna Polarization	ERP Level (dBm)	Limit (dBm)	Margin (dB)	Azimuth (deg)
2	1664.4	-53.21	2.00	10.75	Horizontal	-46.61	-13.00	33.61	225
3	2496.7	-41.61	2.51	11.05	Horizontal	-35.22	-13.00	22.22	135
4	3328.9	-59.60	4.20	11.15	Horizontal	-54.80	-13.00	41.80	180
5	4161.1	-56.67	5.20	11.15	Horizontal	-52.87	-13.00	39.87	315
6	4993.3	-54.94	5.50	11.95	Horizontal	-50.64	-13.00	37.64	45
7	5825.6	-57.53	5.70	13.55	Horizontal	-51.83	-13.00	38.83	90
8	6657.8	-57.65	6.30	13.75	Horizontal	-52.35	-13.00	39.35	315
9	7490.0	-55.09	6.80	13.85	Horizontal	-50.19	-13.00	37.19	0
10	8322.2	-55.81	6.90	14.25	Horizontal	-50.61	-13.00	37.61	180

Note: 1.The other Spurious RF Radiated emissions level is no more than noise floor.

2.The worst emission was found in the antenna is Horizontal position.

6. Main Test Instruments

Name	Manufacturer	Type	Serial Number	Calibration Date	Expiration Date
Base Station Simulator	R&S	CMW500	113824	2019-05-19	2020-05-18
Power Splitter	Hua Xiang	SHX-GF2-2-13	10120101	/	/
Spectrum Analyzer	Key sight	N9010A	MY50210259	2019-05-19	2020-05-18
Universal Radio Communication Tester	Key sight	E5515C	MY48367192	2019-05-19	2020-05-18
Signal Analyzer	R&S	FSV40	101298	2019-05-19	2020-05-18
Loop Antenna	SCHWARZBECK	FMZB1519	1519-047	2017-09-26	2020-09-25
Trilog Antenna	SCHWARZBECK	VUBL 9163	9163-201	2017-11-18	2020-11-17
Horn Antenna	R&S	HF907	100126	2018-07-07	2020-07-06
Horn Antenna	ETS-Lindgren	3160-09	00102643	2018-06-20	2020-06-19
Signal generator	R&S	SMB 100A	102594	2019-05-19	2020-05-18
Climatic Chamber	ESPEC	SU-242	93000506	2017-12-17	2020-12-16
Preamplifier	R&S	SCU18	102327	2019-05-19	2020-05-18
MOB COMMS DC SUPPLY	Keysight	66319D	MY43004105	2019-05-20	2020-05-21
RF Cable	Agilent	SMA 15cm	0001	2019-12-13	2020-6-12
Software	R&S	EMC32	9.26.0	/	/
Wireless Test Set	StarPoint	SP8315	SP8315-1202	2019-05-19	2020-05-18
Wireless Test Set	StarPoint	SP8315	SP8315-1203	2019-05-19	2020-05-18



ANNEX A: Product Change Description

Quectel Wireless Solutions Co., Ltd

Statement

We **Quectel Wireless Solutions Co., Ltd** declare the following models.

Product Name: Cat M1 Module

Model Number: BG95-M3, BG95-M1

Hardware Version: R2.1

Module	Category	Supported Band
BG95-M3	CatM1/NB-IoT/ GSM/GPRS/EGPRS	Cat M1: LTE-FDD: B1/B2/B3/B4/B5/B8/B12/B13/ B14/B18/B19/B20/B25/B26/B27/ B28/B66/B85 Cat NB2: LTE-FDD:B1/B2/B3/B4/B5/B8/B12/B13/ B18/B19/B20/B25/B26/ B28/B66/B71/B85 GSM/GPRS/ EGPRS: 850/900/1800/1900MHz
BG95-M1	CatM1	Cat M1: LTE-FDD:B1/B2/B3/B4/B5/B8/B12/B13/ B14/B18/B19/B20/B25/B26/ B27/B28/B66/B85

BG95-M1 and BG95-M3 share the same HW design, BG95-M1 only do removal of the component for GSM/GPRS/EGPRS on the hardware network according to the model requirement of the product definition, and BG95-M1 disable NB by SW on the basis of BG95-M3.

Quectel Wireless Solutions Co., Ltd

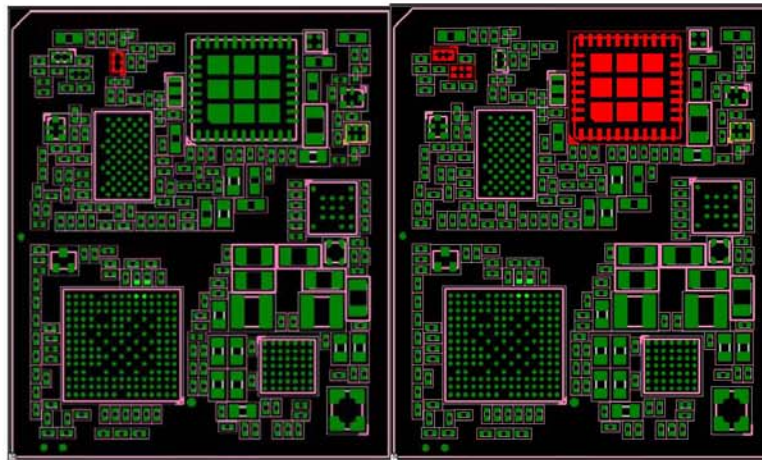

BG95-M3

BG95-M1

Designator	BG95-M3 (Part Description)	BG95-M1 (Part Description)
U602	NA	IC RF THIN-FILM Directional Coupler 450MHz-3800MHz 1.0x0.5mm H0.3mm RO
U603	IC RF SWITCH SP10T + GSM Qualband 5.3x5.5mm H0.905mm RO	NA
U502	IC RF LOW PASS FILTER 698-960MHz 1.0x0.5mm H0.4mm RO	NA
U504	IC RF TX LPF 1695-2180MHz 1.0x0.5mm H0.5mm RO	NA

The change will not impact RF performance of Cat M1 .

Your assistance on this matter is highly appreciated.

Sincerely,

Name: Jean Hu 

Title: Certification Section

*****END OF REPORT *****