

CAPSTONE COMPANIES, INC.

RF TEST REPORT

Report Type:

FCC Part 15.247 RF report

Model:

Standard Mirror,
Wardrobe Mirror

REPORT NUMBER:

210601768SHA-002

ISSUE DATE:

October 18, 2021

DOCUMENT CONTROL NUMBER:

TTRF15.247-01_V1 © 2018 Intertek



Applicant: CAPSTONE COMPANIES, INC.
431 FAIRWAY DRIVE, SUITE 200, DEERFIELD BEACH, FL 33441 USA

Manufacturer: PRO CONCEPT MANUFACTURER CO., LTD.
88/1 MOO 12, SOI PETCHKASEM 120,PETCHKASEM RD. OM NOI,
KRATUMBAN, SAMUTSAKORN THAILAND 74130

FCC ID: 2A3GYCAP-1807

SUMMARY:

The equipment complies with the requirements according to the following standard(s) or Specification:

47CFR Part 15 (2020): Radio Frequency Devices (Subpart C)

ANSI C63.10 (2013): American National Standard of Procedures for Compliance Testing of Unlicensed Wireless Devices

PREPARED BY:

REVIEWED BY:



Project Engineer
Eric Li

Reviewer
Daniel Zhao

This report is for the exclusive use of Intertek's Client and is provided pursuant to the agreement between Intertek and its Client. Intertek's responsibility and liability are limited to the terms and conditions of the agreement. Intertek assumes no liability to any party, other than to the Client in accordance with the agreement, for any loss, expense or damage occasioned by the use of this report. Only the Client is authorized to permit copying or distribution of this report and then only in its entirety. Any use of the Intertek name or one of its marks for the sale or advertisement of the tested material, product or service must first be approved in writing by Intertek. The observations and test results in this report are relevant only to the sample tested. This report by itself does not imply that the material, product, or service is or has ever been under an Intertek certification program.

TEST REPORT

Content

REVISION HISTORY..... 5

MEASUREMENT RESULT SUMMARY 6

1 GENERAL INFORMATION 7

 1.1 DESCRIPTION OF EQUIPMENT UNDER TEST (EUT) 7

 1.2 TECHNICAL SPECIFICATION 7

 1.3 FREQUENCY HOPPING SYSTEM REQUIREMENT 8

 1.4 DESCRIPTION OF TEST FACILITY 10

2 TEST SPECIFICATIONS..... 11

 2.1 STANDARDS OR SPECIFICATION 11

 2.2 MODE OF OPERATION DURING THE TEST 11

 2.3 TEST SOFTWARE LIST 12

 2.4 TEST PERIPHERALS LIST 12

 2.5 TEST ENVIRONMENT CONDITION:..... 12

 2.6 INSTRUMENT LIST 13

 2.7 MEASUREMENT UNCERTAINTY 15

3 20DB BANDWIDTH 16

 3.1 LIMIT 16

 3.2 MEASUREMENT PROCEDURE 16

 3.3 TEST CONFIGURATION 17

 3.4 TEST RESULTS OF 20dB BANDWIDTH..... 17

4 CARRIER FREQUENCY SEPARATION..... 18

 4.1 LIMIT 18

 4.2 TEST CONFIGURATION 18

 4.3 TEST PROCEDURE AND TEST SETUP 18

 4.4 TEST RESULTS OF CARRIER FREQUENCY SEPARATION 18

5 OUTPUT POWER..... 19

 5.1 LIMIT 19

 5.2 TEST CONFIGURATION 19

 5.3 MEASUREMENT PROCEDURE 19

 5.4 TEST RESULTS OF OUTPUT POWER 19

6 RADIATED EMISSIONS 20

 6.1 LIMIT 20

 6.2 MEASUREMENT PROCEDURE 20

 6.3 TEST CONFIGURATION 22

 6.4 TEST RESULTS OF RADIATED EMISSIONS 24

7 CONDUCTED SPURIOUS EMISSIONS & BAND EDGE 27

 7.1 LIMIT 27

 7.2 TEST CONFIGURATION 27

 7.3 MEASUREMENT PROCEDURE 27

 7.4 TEST RESULTS OF CONDUCTED SPURIOUS EMISSIONS & BAND EDGE 28

8 POWER LINE CONDUCTED EMISSION..... 29

 8.1 LIMIT 29

 8.2 TEST CONFIGURATION 29

 8.3 MEASUREMENT PROCEDURE 30

TEST REPORT

- 8.4 TEST RESULTS OF POWER LINE CONDUCTED EMISSION..... 31
- 9 NUMBER OF HOPPING FREQUENCIES 33**
 - 9.1 LIMIT 33
 - 9.2 TEST CONFIGURATION 33
 - 9.3 TEST PROCEDURE AND TEST SETUP 33
 - 9.4 TEST RESULTS OF NUMBER OF HOPPING FREQUENCIES 33
- 10 DWELL TIME 34**
 - 10.1 LIMIT 34
 - 10.2 TEST CONFIGURATION 34
 - 10.3 TEST PROCEDURE AND TEST SETUP 34
 - 10.4 TEST RESULTS OF DWELL TIME 35
- 11 OCCUPIED BANDWIDTH 36**
 - 11.1 LIMIT 36
 - 11.2 MEASUREMENT PROCEDURE 36
 - 11.3 TEST CONFIGURATION 36
 - 11.4 THE RESULTS OF OCCUPIED BANDWIDTH 36
- 12 ANTENNA REQUIREMENT 37**
- APPENDIX A: TEST RESULTS 38**

Revision History

Report No.	Version	Description	Issued Date
210601768SHA-002	Rev. 01	Initial issue of report	October 18, 2021

Measurement result summary

TEST ITEM	FCC REFERANCE	RESULT
20 dB Bandwidth	15.247(a)(1)	Pass
Carrier Frequency Separation	15.247(a)(1)	Pass
Output power	15.247(b)(1)	Pass
Radiated Emissions	15.205 & 15.209	Pass
Conducted Spurious Emissions & Band Edge	15.247(d)	Pass
Power line conducted emission	15.207	Pass
Number of Hopping Frequencies	15.247(a)(1)(iii)	Pass
Dwell time	15.247(a)(1)(iii)	Pass
Occupied bandwidth	-	Tested
Antenna requirement	15.203	Pass

Notes: 1: NA =Not Applicable

TEST REPORT

1 GENERAL INFORMATION

1.1 Description of Equipment Under Test (EUT)

Product name:	Thin Cast Smart Mirror
Type/Model:	Standard Mirror, Wardrobe Mirror
Description of EUT:	EUT is a Smart Mirror with WiFi function and Bluetooth function, there are two models, they are identical except for the size of mirror, so we test Wardrobe Mirror as representative and list the worst results in this report.
Rating:	12.0Vdc, 4.0A, 48.0W
EUT type:	<input type="checkbox"/> Table top <input checked="" type="checkbox"/> Floor standing
Software Version:	/
Hardware Version:	/
Sample Identification No.:	0210919-46-001
Sample received date:	September 26, 2021
Date of test:	September 27, 2021 ~ October 15, 2021

1.2 Technical Specification

Frequency Band:	2400MHz ~ 2483.5MHz
Support Standards:	Bluetooth BR+EDR
Operating Frequency:	2402MHz to 2480MHz
Modulation Technique:	Frequency Hopping Spread Spectrum(FHSS)
Type of Modulation:	GFSK, $\pi/4$ -DQPSK, 8DPSK
Channel Number:	79 (0 - 78)
Channel Separation:	1 MHz
Antenna:	PCB Antenna, 1.0dBi

TEST REPORT

1.3 Frequency Hopping System Requirement

Test Requirement: Section 15.247 (a)(1), (g), (h) requirement:

The system shall hop to channel frequencies that are selected at the system hopping rate from a Pseudorandom ordered list of hopping frequencies. Each frequency must be used equally on the average by each transmitter. The system receivers shall have input bandwidths that match the hopping channel bandwidths of their corresponding transmitters and shall shift frequencies in synchronization with the transmitted signals.

Frequency hopping spread spectrum systems are not required to employ all available hopping channels during each transmission. However, the system, consisting of both the transmitter and the receiver, must be designed to comply with all of the regulations in this section should the transmitter be presented with a continuous data (or information) stream. In addition, a system employing short transmission bursts must comply with the definition of a frequency hopping system and must distribute its transmissions over the minimum number of hopping channels specified in this section.

The incorporation of intelligence within a frequency hopping spread spectrum system that permits the system to recognize other users within the spectrum band so that it individually and independently chooses and adapts its hop sets to avoid hopping on occupied channels is permitted. The coordination of frequency hopping systems in any other manner for the express purpose of avoiding the simultaneous occupancy of individual hopping frequencies by multiple transmitters is not permitted.

Compliance for section 15.247(a)(1)

According to Bluetooth Core Specification, the pseudorandom sequence may be generated in a nine stages shift register whose 5th and 9th stage outputs are added in a modulo-two addition stage. And the result is fed back to the input of the first stage. The sequence begins with the first ONE of 9 consecutive ONES;

i.e. the shift register is initialized with nine ones.

- Number of shift register stages: 9
- Length of pseudo-random sequence: $2^9 - 1 = 511$ bits
- Longest sequence of zeros: 8 (non-inverted signal)

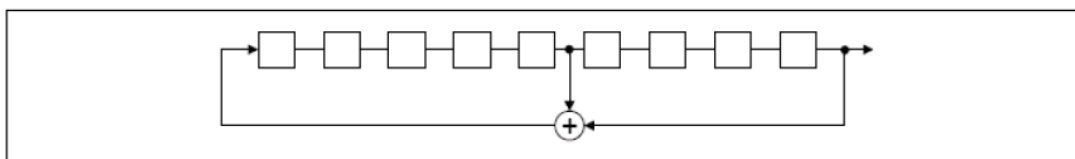

Linear Feedback Shift Register for Generation of the PRBS sequence

TEST REPORT

An example of Pseudorandom Frequency Hopping Sequence as follow:

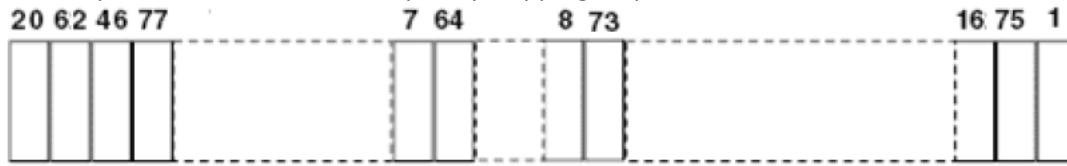

Each frequency used equally on the average by each transmitter.

According to Bluetooth Core Specification, Bluetooth receivers are designed to have input and IF bandwidths that match the hopping channel bandwidths of any Bluetooth transmitters and shift frequencies in synchronization with the transmitted signals.

Compliance for section 15.247(g)

According to Bluetooth Core Specification, the Bluetooth system transmits the packet with the pseudorandom hopping frequency with a continuous data and the short burst transmission from the Bluetooth system is also transmitted under the frequency hopping system with the pseudorandom hopping frequency system.

Compliance for section 15.247(h)

According to Bluetooth Core specification, the Bluetooth system incorporates with an adaptive system to detect other user within the spectrum band so that it individually and independently to avoid hopping on the occupied channels.

According to the Bluetooth Core specification, the Bluetooth system is designed not have the ability to coordinate with other FHSS System in an effort to avoid the simultaneous occupancy of individual hopping frequencies by multiple transmitter.

TEST REPORT

1.4 Description of Test Facility

Name:	Intertek Testing Services Shanghai
Address:	Building 86, No. 1198 Qinzhou Road(North), Shanghai 200233, P.R. China
Telephone:	86 21 61278200
Telefax:	86 21 54262353

The test facility is recognized, certified, or accredited by these organizations:	CNAS Accreditation Lab Registration No. CNAS L0139
	FCC Accredited Lab Designation Number: CN1175
	IC Registration Lab CAB identifier.: CN0051
	VCCI Registration Lab Registration No.: R-14243, G-10845, C-14723, T-12252
	A2LA Accreditation Lab Certificate Number: 3309.02

TEST REPORT

2 TEST SPECIFICATIONS

2.1 Standards or specification

47CFR Part 15 (2020)
ANSI C63.10 (2013)
KDB 558074 (v05r02)

2.2 Mode of operation during the test

While testing the transmitter mode of the EUT, the internal modulation is applied.
All the functions of the host device except the BT module were set on stand-by mode.

Software name	Manufacturer	Version	Supplied by
QRCT	Qualcomm	-	Client

The lowest, middle and highest channel were tested as representatives.

Frequency Band (MHz)	Mode	Lowest (MHz)	Middle (MHz)	Highest (MHz)
2400-2483.5	GFSK	2402	2441	2480
	$\pi/4$ -DQPSK	2402	2441	2480
	8DPSK	2402	2441	2480

The worst-case modulation configuration:

Worst Modulation Used for Conformance Testing			
Bluetooth Mode	Data Rate	Packet Type	Worst Mode
GFSK	BR-1Mbps	DH1,DH3,DH5	BR-1Mbps DH5 EDR-2Mbps 2DH5 EDR-3Mbps 3DH5
$\pi/4$ -DQPSK	EDR-2Mbps	2DH1,2DH3,2DH5	
8DPSK	EDR-3Mbps	3DH1,3DH3,3DH5	

Note: The BR-1Mbps DH5 mode was chosen for radiation emission bellow 1GHz and Conducted emission testing as representative in this report.

Power Setting parameter			
Mode	Channel		
	Lowest	Middle	Highest
GFSK	Default	Default	Default
$\pi/4$ -DQPSK	Default	Default	Default
8DPSK	Default	Default	Default

TEST REPORT

2.3 Test software list

Test Items	Software	Manufacturer	Version
Conducted emission	ESxS-K1	R&S	V2.1.0
Radiated emission	ES-K1	R&S	V1.71

2.4 Test peripherals list

Item No.	Name	Band and Model	Description
1	Laptop computer	DELL 5480	-

2.5 Test environment condition:

Test items	Temperature	Humidity
20 dB Bandwidth	22°C	54%RH
Output power		
Carrier Frequency Separation		
Number of Hopping Frequencies		
Dwell time		
Occupied bandwidth		
Conducted Spurious Emissions & Band Edge	24°C	56%RH
Radiated Emissions		
Power line conducted emission		

TEST REPORT

2.6 Instrument list

Conducted Emission					
Used	Equipment	Manufacturer	Type	Internal no.	Due date
<input checked="" type="checkbox"/>	Test Receiver	R&S	ESCS 30	EC 2107	2022-07-14
<input checked="" type="checkbox"/>	A.M.N.	R&S	ESH2-Z5	EC 3119	2021-11-10
<input type="checkbox"/>	A.M.N.	R&S	ENV 216	EC 3393	2022-07-14
<input type="checkbox"/>	A.M.N.	R&S	ENV4200	EC 3558	2022-06-11
Radiated Emission					
Used	Equipment	Manufacturer	Type	Internal no.	Due date
<input checked="" type="checkbox"/>	Test Receiver	R&S	ESIB 26	EC 3045	2022-09-16
<input checked="" type="checkbox"/>	Bilog Antenna	TESEQ	CBL 6112D	EC 4206	2022-09-24
<input checked="" type="checkbox"/>	Pre-amplifier	R&S	AFS42-00101800-25-S-42	EC5262	2022-06-11
<input type="checkbox"/>	Horn antenna	R&S	HF 906	EC 3049	2022-01-17
<input type="checkbox"/>	Horn antenna	ETS	3117	EC 4792-1	2021-02-25
<input checked="" type="checkbox"/>	Horn antenna	TOYO	HAP18-26W	EC 4792-3	2022-07-09
<input checked="" type="checkbox"/>	Active loop antenna	Schwarzbeck	FMZB1519	EC 5345	2022-03-14
RF test					
Used	Equipment	Manufacturer	Type	Internal no.	Due date
<input checked="" type="checkbox"/>	PXA Signal Analyzer	Keysight	N9030A	EC 5338	2022-03-16
<input type="checkbox"/>	Power sensor	Agilent	U2021XA	EC 5338-1	2022-03-16
<input type="checkbox"/>	Vector Signal Generator	Agilent	N5182B	EC 5175	2022-03-16
<input type="checkbox"/>	Universal Radio Communication Tester	R&S	CMW500	EC5944	2021-12-09
<input type="checkbox"/>	MXG Analog Signal Generator	Agilent	N5181A	EC 5338-2	2022-03-16
<input type="checkbox"/>	Mobile Test System	Litepoint	lqxel	EC 5176	2022-01-16
<input type="checkbox"/>	Test Receiver	R&S	ESCI 7	EC 4501	2022-09-16
<input type="checkbox"/>	Climate chamber	GWS	MT3065	EC 6021	2022-07-04
<input checked="" type="checkbox"/>	Spectrum Analyzer	Keysight	N9030B	EC 6078	2022-06-11
Tet Site					
Used	Equipment	Manufacturer	Type	Internal no.	Due date
<input checked="" type="checkbox"/>	Shielded room	Zhongyu	-	EC 2838	2022-01-12
<input type="checkbox"/>	Shielded room	Zhongyu	-	EC 2839	2022-01-12

TEST REPORT

<input checked="" type="checkbox"/>	Semi-anechoic chamber	Albatross project	-	EC 3048	2022-07-14
<input type="checkbox"/>	Fully-anechoic chamber	Albatross project	-	EC 3047	2022-07-14
Additional instrument					
Used	Equipment	Manufacturer	Type	Internal no.	Due date
<input checked="" type="checkbox"/>	Therom-Hygrograph	ZJ1-2A	S.M.I.F.	EC 3783	2022-03-03
<input type="checkbox"/>	Therom-Hygrograph	ZJ1-2A	S.M.I.F.	EC 3481	2022-01-05
<input checked="" type="checkbox"/>	Therom-Hygrograph	ZJ1-2A	S.M.I.F.	EC 3442	2022-01-05
<input checked="" type="checkbox"/>	Therom-Hygrograph	ZJ1-2A	S.M.I.F.	EC 3324	2022-09-05
<input type="checkbox"/>	Pressure meter	YM3	Shanghai Mengde	EC 3320	2022-07-14

TEST REPORT**2.7 Measurement uncertainty**

The measurement uncertainty represents an expanded uncertainty expressed at approximately the 95% confidence level using a coverage factor of k=2.

Test item	Measurement uncertainty
Maximum peak output power	$\pm 0.74\text{dB}$
Radiated Emissions in restricted frequency bands below 1GHz	$\pm 4.90\text{dB}$
Radiated Emissions in restricted frequency bands above 1GHz	$\pm 5.02\text{dB}$
Emission outside the frequency band	$\pm 2.89\text{dB}$
Power line conducted emission	$\pm 3.19\text{dB}$

TEST REPORT

3 20dB bandwidth

Test result: Pass

3.1 Limit

Frequency hopping systems shall have hopping channel carrier frequencies separated by a minimum of 25 kHz or the 20 dB bandwidth of the hopping channel, whichever is greater.

Frequency hopping systems operating in the 2400–2483.5 MHz band may have hopping channel carrier frequencies that are separated by 25 kHz or two-thirds of the 20 dB bandwidth of the hopping channel, whichever is greater, provided the systems operate with an output power no greater than 125mW.

3.2 Measurement Procedure

The EUT was tested according to Subclause 7.8 of ANSI C63.10.

- a) The spectrum analyzer center frequency is set to the nominal EUT channel center frequency. The span range for the EMI receiver or spectrum analyzer shall be between two times and five times the OBW.
- b) The nominal IF filter bandwidth (3 dB RBW) shall be in the range of 1% to 5% of the OBW and video bandwidth (VBW) shall be approximately three times RBW, unless otherwise specified by the applicable requirement.
- c) Set the reference level of the instrument as required, keeping the signal from exceeding the maximum input mixer level for linear operation. In general, the peak of the spectral envelope shall be more than $[10 \log (OBW/RBW)]$ below the reference level.
- d) Steps a) through c) might require iteration to adjust within the specified tolerances.
- e) The dynamic range of the instrument at the selected RBW shall be more than 10 dB below the target “-xx dB down” requirement; that is, if the requirement calls for measuring the -20 dB OBW, the instrument noise floor at the selected RBW shall be at least 30 dB below the reference value.
- f) Set detection mode to peak and trace mode to max hold.
- g) Determine the reference value: Set the EUT to transmit an unmodulated carrier or modulated signal, as applicable. Allow the trace to stabilize. Set the spectrum analyzer marker to the highest level of the displayed trace (this is the reference value).
- h) Determine the “-xx dB down amplitude” using $[(\text{reference value}) - xx]$. Alternatively, this calculation may be made by using the marker-delta function of the instrument.
- i) If the reference value is determined by an unmodulated carrier, then turn the EUT modulation ON, and either clear the existing trace or start a new trace on the spectrum analyzer and allow the new trace to stabilize. Otherwise, the trace from step g) shall be used for step j).
- j) Place two markers, one at the lowest frequency and the other at the highest frequency of the envelope of the spectral display, such that each marker is at or slightly below the “-xx dB down amplitude” determined in step h). If a marker is below this “-xx dB down amplitude” value, then it shall be as close as possible to this value. The occupied bandwidth is the frequency difference between the two markers. Alternatively, set a marker at the lowest frequency of the envelope of the spectral display, such that the marker is at or slightly below the “-xx dB down amplitude” determined in step h). Reset the marker-delta function and move the marker to the

TEST REPORT

other side of the emission until the delta marker amplitude is at the same level as the reference marker amplitude. The marker-delta frequency reading at this point is the specified emission bandwidth.

- k) The occupied bandwidth shall be reported by providing plot(s) of the measuring instrument display; the plot axes and the scale units per division shall be clearly labeled. Tabular data may be reported in addition to the plot(s).

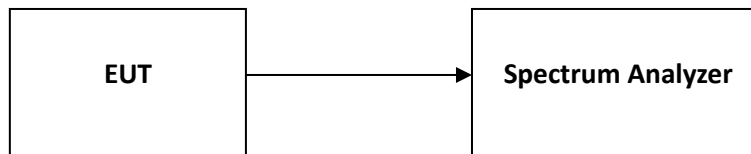
3.3 Test Configuration**3.4 Test Results of 20dB bandwidth**

Please refer to Appendix A.

TEST REPORT

4 Carrier Frequency Separation

Test result: Pass

4.1 Limit

Frequency hopping systems shall have hopping channel carrier frequencies separated by a minimum of 25kHz or the 20 dB bandwidth of the hopping channel, whichever is greater.

Frequency hopping systems operating in the 2400–2483.5 MHz band may have hopping channel carrier frequencies that are separated by 25 kHz or two-thirds of the 20 dB bandwidth of the hopping channel, whichever is greater, provided the systems operate with an output power no greater than 125mW.

4.2 Test Configuration

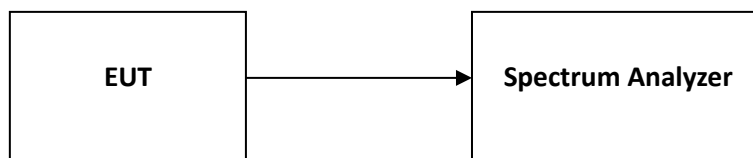

4.3 Test Procedure and test setup

The EUT was tested according to Subclause 7.8 of ANSI C63.10.

The EUT shall have its hopping function enabled. Use the following spectrum analyzer settings:

- a) Span: Wide enough to capture the peaks of two adjacent channels.
- b) RBW: Start with the RBW set to approx. imately 30% of the channel spacing; adjust as necessary to best identify the center of each individual channel.
- c) Video (or average) bandwidth (VBW) ≥ RBW.
- d) Sweep: Auto.
- e) Detector function: Peak.
- f) Trace: Max hold.
- g) Allow the trace to stabilize.
- a) Use the marker-delta function to determine the separation between the peaks of the adjacent channels.
- b) Compliance of an EUT with the appropriate regulatory limit shall be determined. A plot of the data shall be included in the test report.

4.4 Test Results of Carrier Frequency Separation

Please refer to Appendix A.

TEST REPORT**5 Output power****Test result: Pass****5.1 Limit**

For frequency hopping systems operating in the 2400-2483.5 MHz band employing at least 75 non-overlapping hopping channels, and all frequency hopping systems in the 5725-5850 MHz band: 1 watt. (The e.i.r.p. shall not exceed 4 W)

If the transmitting antenna of directional gain greater than 6dBi is used, the power shall be reduced by the amount in dB that the directional gain of the antenna exceeds 6dBi.

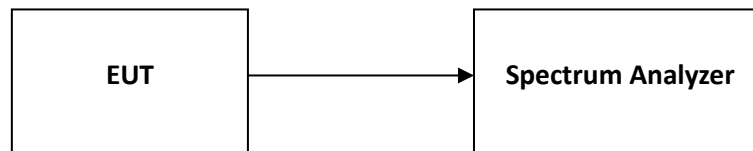
5.2 Test Configuration**5.3 Measurement Procedure**

The EUT was tested according to Subclause 7.8 of ANSI C63.10.

This is an RF-conducted test to evaluate maximum peak output power. Use a direct connection between the antenna port of the unlicensed wireless device and the spectrum analyzer, through suitable attenuation. The hopping shall be disabled for this test:

- a) Use the following spectrum analyzer settings:
 - 1) Span: Approximately five times the 20 dB bandwidth, centered on a hopping channel.
 - 2) RBW > 20 dB bandwidth of the emission being measured.
 - 3) VBW \geq RBW.
 - 4) Sweep: Auto.
 - 5) Detector function: Peak.
 - 6) Trace: Max hold.
- b) Allow trace to stabilize.
- c) Use the marker-to-peak function to set the marker to the peak of the emission.
- d) The indicated level is the peak output power, after any corrections for external attenuators and cables.
- e) A plot of the test results and setup description shall be included in the test report.

5.4 Test Results of Output Power

Please refer to Appendix A.

TEST REPORT

6 Radiated Emissions

Test result: Pass

6.1 Limit

The radiated emissions which fall in the restricted bands, must also comply with the radiated emission limits specified showed as below:

Frequencies (MHz)	Field Strength (microvolts/meter)	Measurement Distance (meters)
0.009 ~ 0.490	2400/F(kHz)	300
0.490 ~ 1.705	24000/F(kHz)	30
1.705 ~ 30.0	30	30
30 ~ 88	100	3
88 ~ 216	150	3
216 ~ 960	200	3
Above 960	500	3

6.2 Measurement Procedure

For Radiated emission below 30MHz:

- a) For desk-top devices the EUT was placed on the top of a rotating table 0.8 meters (for 30MHz ~ 1GHz) / 1.5 meters (for above 1GHz), For the floor-standing devices, the EUT was placed on the top of a rotating table 0.1 meters above the ground at 3 meters chamber room for test. The table was rotated 360 degrees to determine the position of the highest radiation.
- b) The EUT was set 3 meters away from the interference-receiving antenna, which was mounted on the top of a variable-height antenna tower.
- c) Both X and Y axes of the antenna are set to make the measurement.
- d) For each suspected emission, the EUT was arranged to its worst case and the rotatable table was turned from 0 degrees to 360 degrees to find the maximum reading.
- e) The test-receiver system was set to Quasi-Peak Detect Function and Specified Bandwidth with Maximum Hold Mode.

NOTE:

- 1. The resolution bandwidth and video bandwidth of test receiver/spectrum analyzer is 9kHz at frequency below 30MHz.

TEST REPORT

For Radiated emission above 30MHz:

- a) For desk-top devices the EUT was placed on the top of a rotating table 0.8 meters (for 30MHz ~ 1GHz) / 1.5 meters (for above 1GHz), For the floor-standing devices, the EUT was placed on the top of a rotating table 0.1 meters above the ground at 3 meters chamber room for test. The table was rotated 360 degrees to determine the position of the highest radiation.
- b) The EUT was set 3 meters away from the interference-receiving antenna, which was mounted on the top of a variable-height antenna tower.
- c) The height of antenna is varied from one meter to four meters above the ground to determine the maximum value of the field strength. Both horizontal and vertical polarizations of the antenna are set to make the measurement.
- d) For each suspected emission, the EUT was arranged to its worst case and then the antenna was tuned to heights from 1 meter to 4 meters and the rotatable table was turned from 0 degrees to 360 degrees to find the maximum reading.
- e) The test-receiver system was set to quasi-peak detect function and specified bandwidth with maximum hold mode when the test frequency is below 1 GHz.
- f) The test-receiver system was set to peak and average detector function and specified bandwidth with maximum hold mode when the test frequency is above 1 GHz. If the peak reading value also meets average limit, measurement with the average detector is unnecessary.

Note:

1. The resolution bandwidth and video bandwidth of test receiver/spectrum analyzer is 120kHz for Quasi-peak detection (QP) at frequency below 1GHz.
2. The resolution bandwidth of test receiver/spectrum analyzer is 1 MHz and the video bandwidth is 3 MHz for Peak detection (PK) at frequency above 1GHz.
3. The resolution bandwidth of test receiver/spectrum analyzer is 1 MHz and the video bandwidth is $\geq 1/T$ (Duty cycle < 98%) or 3 x RBW (Duty cycle \geq 98%) for Average detection (AV) at frequency above 1GHz.
4. All modes of operation were evaluated and the worst-case emissions were reported

TEST REPORT

6.3 Test Configuration

For Radiated emission below 30MHz:

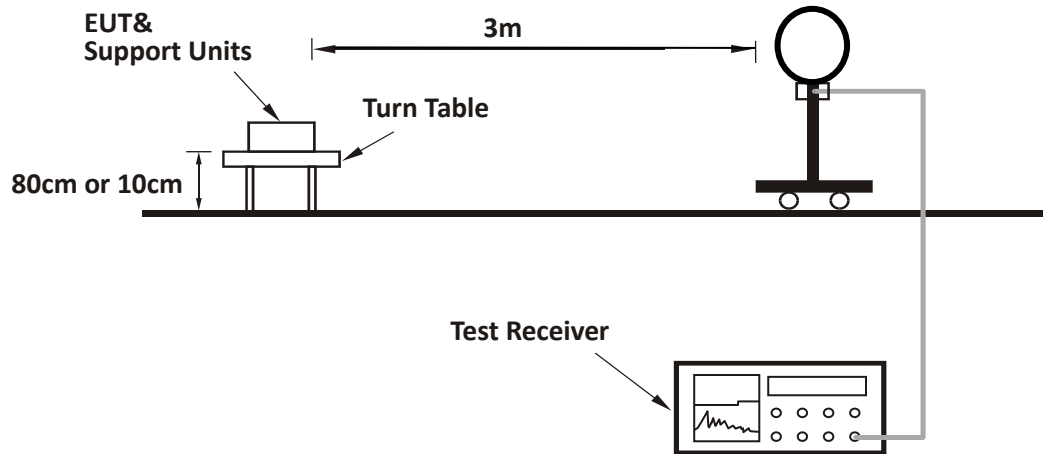

For Radiated emission 30MHz to 1GHz:

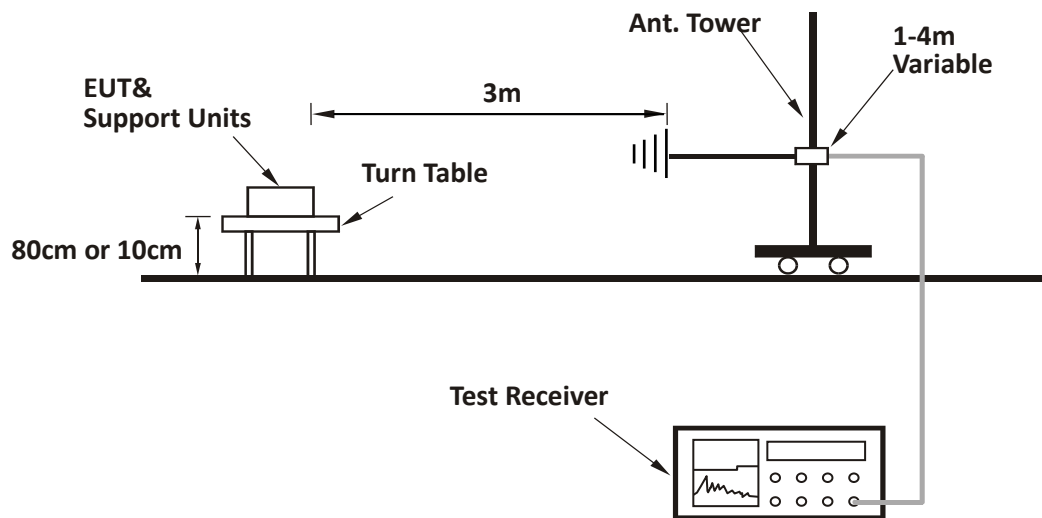

TEST REPORT

For Radiated emission above 1GHz:

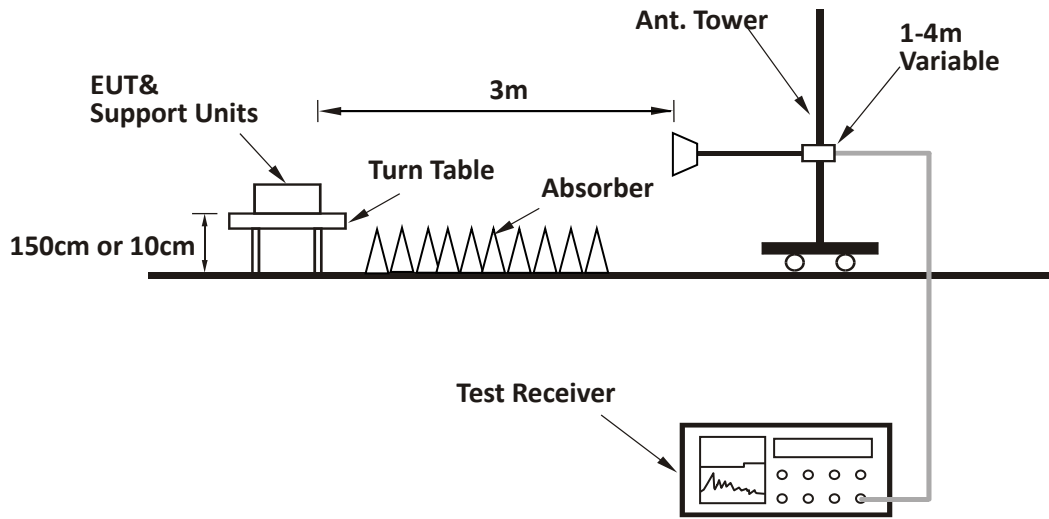

TEST REPORT

6.4 Test Results of Radiated Emissions

The low frequency, which started from 9 kHz to 30MHz, was pre-scanned and the result which was 20dB lower than the limit line per 15.31(o) was not reported. The worst waveform from 30MHz to 1000MHz is listed as below:

Horizontal

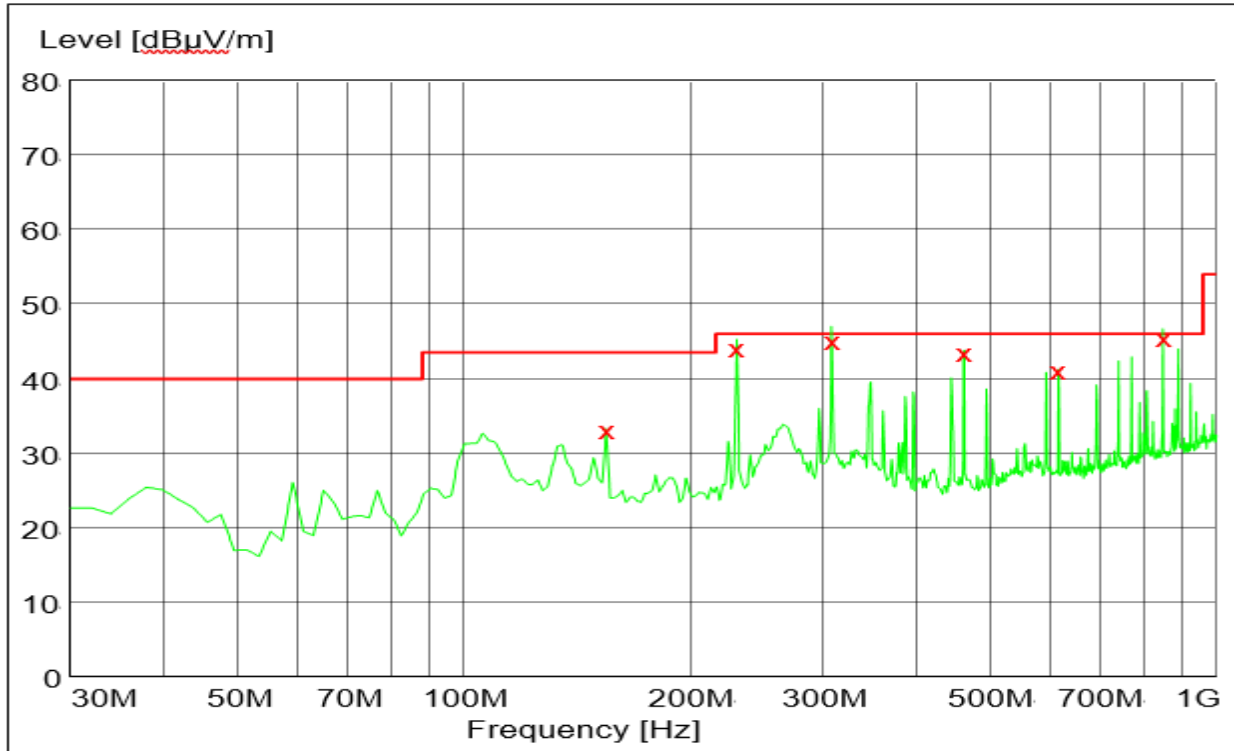

Vertical

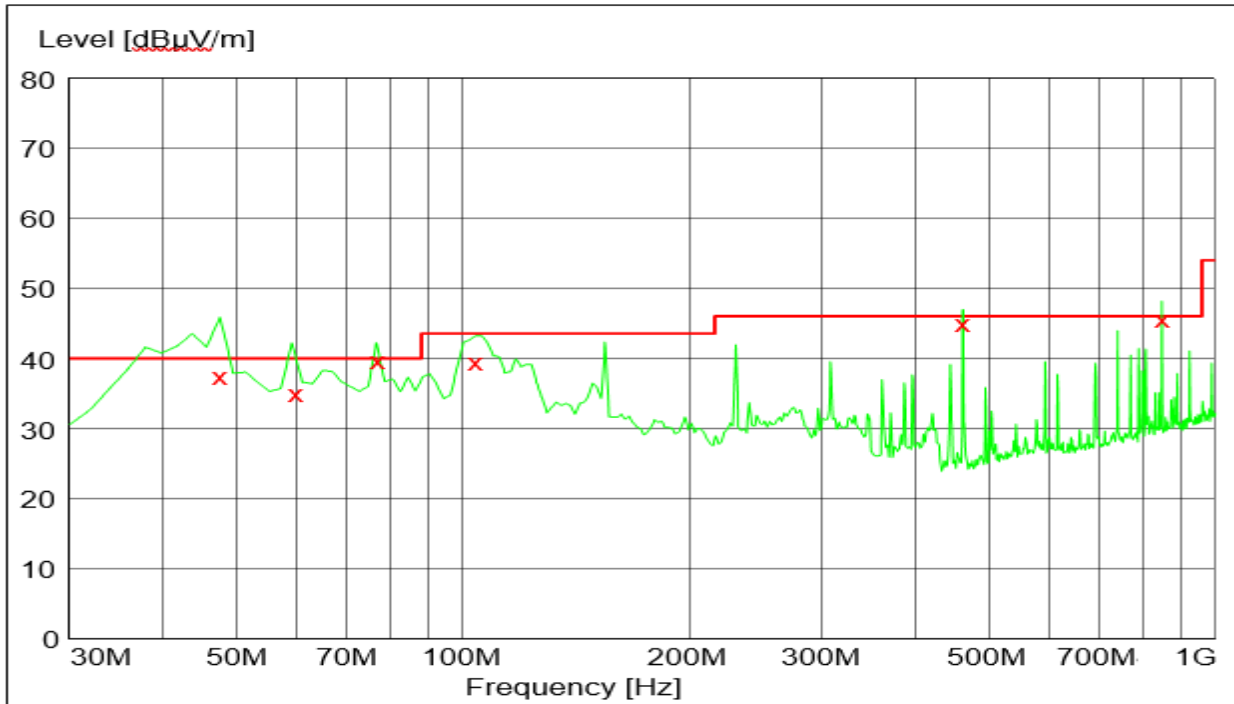

Test data below 1GHz

TEST REPORT

Antenna	Frequency (MHz)	Corrected Reading (dBuV/m)	Limit (dBuV/m)	Margin (dB)	Detector
H	154.41	33.30	43.50	10.20	PK
H	230.22	44.30	46.00	1.70	QP
H	307.98	45.40	46.00	0.60	QP
H	461.54	43.70	46.00	2.30	PK
H	617.05	41.30	46.00	4.70	PK
H	848.38	45.65	46.00	0.40	QP
V	47.49	37.60	40.00	2.40	QP
V	59.90	35.30	40.00	4.70	QP
V	76.97	39.70	40.00	0.30	QP
V	103.87	39.60	43.50	3.90	QP
V	461.54	45.20	46.00	0.80	QP
V	848.38	45.80	46.00	0.20	QP

Test result of 1GHz to 25GHz:

GFSK (DH5) Modulation:

CH	Antenna	Frequency (MHz)	Corrected Reading (dBuV/m)	Limit (dBuV/m)	Margin (dB)	Detector
L	H	2390.00	51.50	74.00	22.70	PK
	V	2390.00	50.60	74.00	22.20	PK
	V	4804.00	45.30	74.00	28.70	PK
M	H	4880.00	45.60	74.00	28.90	PK
	V	4880.00	46.50	74.00	27.60	PK
H	H	2483.50	50.90	74.00	23.30	PK
	V	2483.50	51.40	74.00	22.20	PK
	V	4960.00	46.20	74.00	28.30	PK

TEST REPORT

$\pi/4$ DQPSK (2DH5) Modulation:

CH	Antenna	Frequency (MHz)	Corrected Reading (dBuV/m)	Limit (dBuV/m)	Margin (dB)	Detector
L	H	2390.00	50.80	74.00	22.70	PK
	V	2390.00	51.40	74.00	22.20	PK
	V	4804.00	45.30	74.00	28.70	PK
M	H	4880.00	45.70	74.00	28.90	PK
	V	4880.00	46.20	74.00	27.60	PK
H	H	2483.50	50.80	74.00	23.30	PK
	V	2483.50	51.60	74.00	22.20	PK
	V	4960.00	46.60	74.00	28.30	PK

8DPSK (3DH5) Modulation:

CH	Antenna	Frequency (MHz)	Corrected Reading (dBuV/m)	Limit (dBuV/m)	Margin (dB)	Detector
L	H	2390.00	51.10	74.00	22.70	PK
	V	2390.00	51.60	74.00	22.20	PK
	V	4804.00	45.30	74.00	28.70	PK
M	H	4880.00	45.10	74.00	28.90	PK
	V	4880.00	46.40	74.00	27.60	PK
H	H	2483.50	50.70	74.00	23.30	PK
	V	2483.50	51.80	74.00	22.20	PK
	V	4960.00	45.70	74.00	28.30	PK

Remark: 1. Correct Factor = Antenna Factor + Cable Loss (+ Amplifier, for higher than 1GHz), the value was added to Original Receiver Reading by the software automatically.

2. Corrected Reading = Original Receiver Reading + Correct Factor

3. Margin = Limit - Corrected Reading

4. If the PK Corrected Reading is lower than AV limit, the AV test can be elided.

Example: Assuming Antenna Factor = 30.20dB/m, Cable Loss = 2.00dB,

Gain of Preamplifier = 32.00dB, Original Receiver Reading = 10.00dBuV,

Limit = 40.00dBuV/m.

Then Correct Factor = 30.20 + 2.00 – 32.00 = 0.20dB/m;

Corrected Reading = 10dBuV + 0.20dB/m = 10.20dBuV/m;

Margin = 40.00dBuV/m - 10.20dBuV/m = 29.80dB.

TEST REPORT

7 Conducted Spurious Emissions & Band Edge

Test result: Pass

7.1 Limit

In any 100kHz bandwidth outside the frequency band in which the spread spectrum intentional radiator is operating, the radio frequency power that is produced by the intentional radiator shall be at least 20 dB below that in the 100kHz bandwidth within the band that contains the highest level of the desired power.

7.2 Test Configuration



7.3 Measurement Procedure

- a) Connect the EMI receiver or spectrum analyzer to the EUT using an appropriate RF cable connected to the EUT output. Configure the spectrum analyzer settings as described in step e)
- b) Set the EUT to the lowest frequency channel (for the hopping on test, the hopping sequence shall include the lowest frequency channel).
- c) Set the EUT to operate at maximum output power and 100% duty cycle, or equivalent “normal mode of operation” as specified in 6.10.3. of ANSI C63.10.
- d) If using the radiated method, then use the applicable procedure(s) of 6.4, 6.5, or 6.6 of ANSI C63.10, and orient the EUT and measurement antenna positions to produce the highest emission level.
- e) Perform the test as follows:
 - 1) Span: Wide enough to capture the peak level of the emission operating on the channel closest to the band edge, as well as any modulation products that fall outside of the authorized band of operation.
 - 2) Reference level: As required to keep the signal from exceeding the maximum instrument input mixer level for linear operation. In general, the peak of the spectral envelope shall be more than $[10 \log (OBW/RBW)]$ below the reference level.
 - 3) Attenuation: Auto (at least 10 dB preferred).
 - 4) Sweep time: Coupled.
 - 5) Resolution bandwidth: 100 kHz
 - 6) Video bandwidth: 300 kHz
 - 7) Detector: Peak
 - 8) Trace: Max hold
- f) Allow the trace to stabilize. For the test with the hopping function turned ON, this can take several minutes to achieve a reasonable probability of intercepting any emissions due to oscillator overshoot.

TEST REPORT

- g) Set the marker on the emission at the band edge, or on the highest modulation product outside of
- a) the band, if this level is greater than that at the band edge. Enable the marker-delta function, and then use the marker-to-peak function to move the marker to the peak of the in-band emission.
- h) Repeat step c) through step e) for every applicable modulation.
- i) Set the EUT to the highest frequency channel (for the hopping on test, the hopping sequence shall include the highest frequency channel) and repeat step c) through step d).
- j) The band-edge measurement shall be reported by providing plot(s) of the measuring instrument display; the plot axes and the scale units per division shall be clearly labeled. Tabular data may be reported in addition to the plot(s).

7.4 Test Results of Conducted Spurious Emissions & Band Edge

Please refer to Appendix A

TEST REPORT

8 Power line conducted emission

Test result: Pass

8.1 Limit

Frequency of Emission (MHz)	Conducted Limit (dBuV)	
	QP	AV
0.15-0.5	66 to 56*	56 to 46 *
0.5-5	56	46
5-30	60	50

* Decreases with the logarithm of the frequency.

8.2 Test Configuration

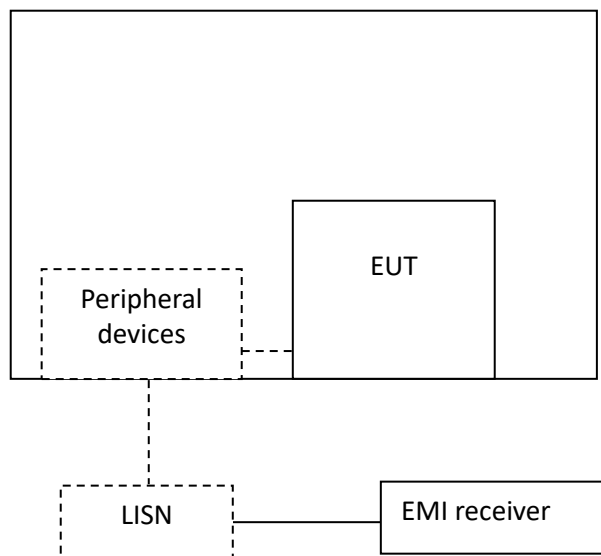

TEST REPORT**8.3 Measurement Procedure**

Measured levels of ac power-line conducted emission shall be the emission voltages from the voltage probe, where permitted, or across the 50 Ω LISN port (to which the EUT is connected), where permitted, terminated into a 50 Ω measuring instrument. All emission voltage and current measurements shall be made on each current-carrying conductor at the plug end of the EUT power cord by the use of mating plugs and receptacles on the LISN, if used. Equipment shall be tested with power cords that are normally supplied or recommended by the manufacturer and that have electrical and shielding characteristics that are the same as those cords normally supplied or recommended by the manufacturer. For those measurements using a LISN, the 50 Ω measuring port is terminated by a measuring instrument having 50 Ω input impedance. All other ports are terminated in 50 Ω loads.

Tabletop devices shall be placed on a platform of nominal size 1 m by 1.5 m, raised 80 cm above the reference ground plane. The vertical conducting plane or wall of an RF-shielded (screened) room shall be located 40 cm to the rear of the EUT. Floor-standing devices shall be placed either directly on the reference ground-plane or on insulating material as described in ANSI C63.4. All other surfaces of tabletop or floor-standing EUTs shall be at least 80 cm from any other grounded conducting surface, including the case or cases of one or more LISNs.

The bandwidth of the test receiver is set at 9 kHz.

TEST REPORT

8.4 Test Results of Power line conducted emission

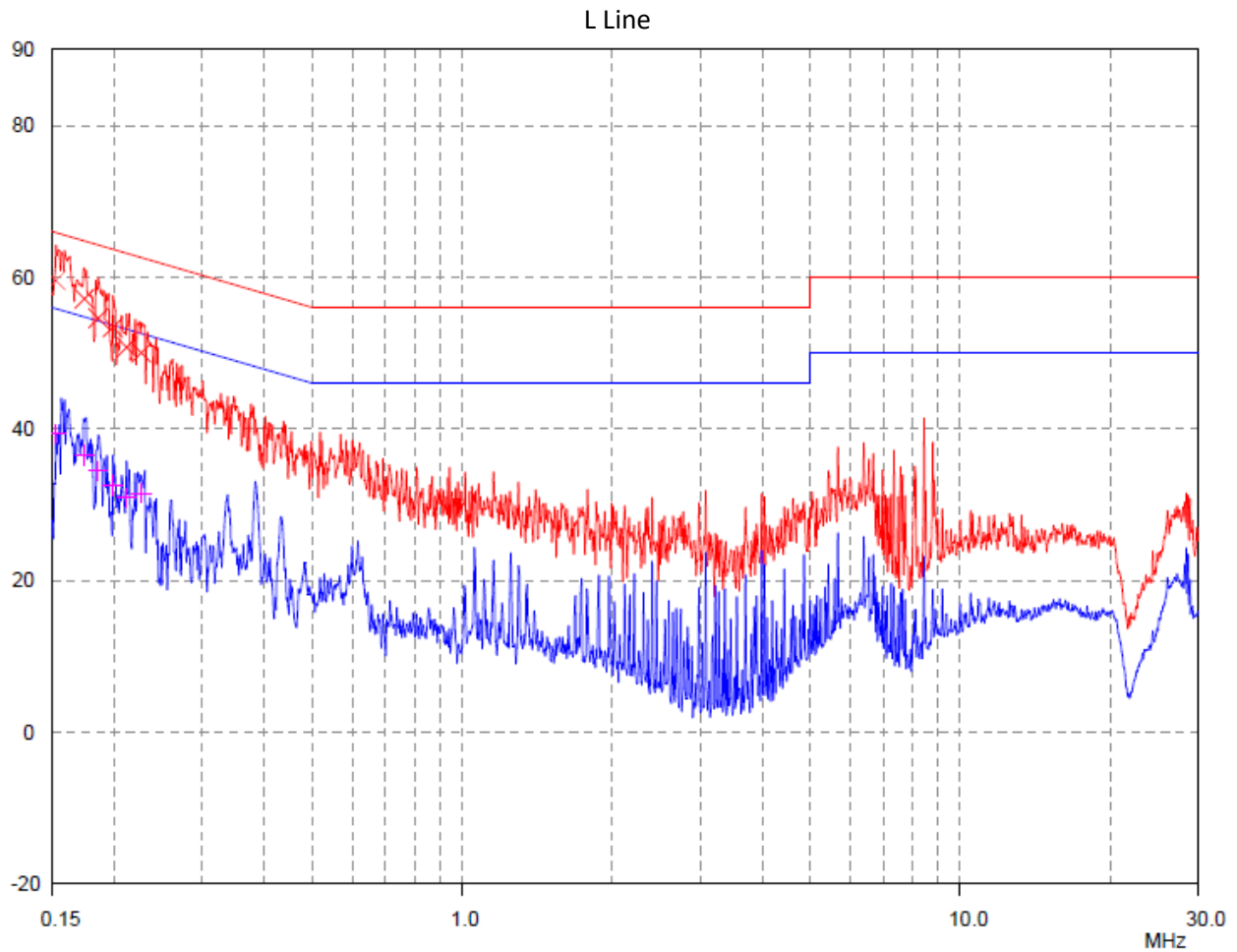

Test Data:

Frequency (MHz)	Quasi-peak			Average		
	level dB(μV)	Limit dB(μV)	Margin (dB)	level dB(μV)	limit dB(μV)	Margin (dB)
0.15	59.56	65.87	6.31	39.31	55.87	16.56
0.17	57.17	64.77	7.60	36.55	54.77	18.22
0.19	54.61	64.24	9.63	34.48	54.24	19.76
0.20	53.41	63.68	10.27	32.62	53.68	21.06
0.21	50.75	63.15	12.40	30.94	53.15	22.21
0.23	50.03	62.59	12.56	31.51	52.59	21.08

TEST REPORT

N Line

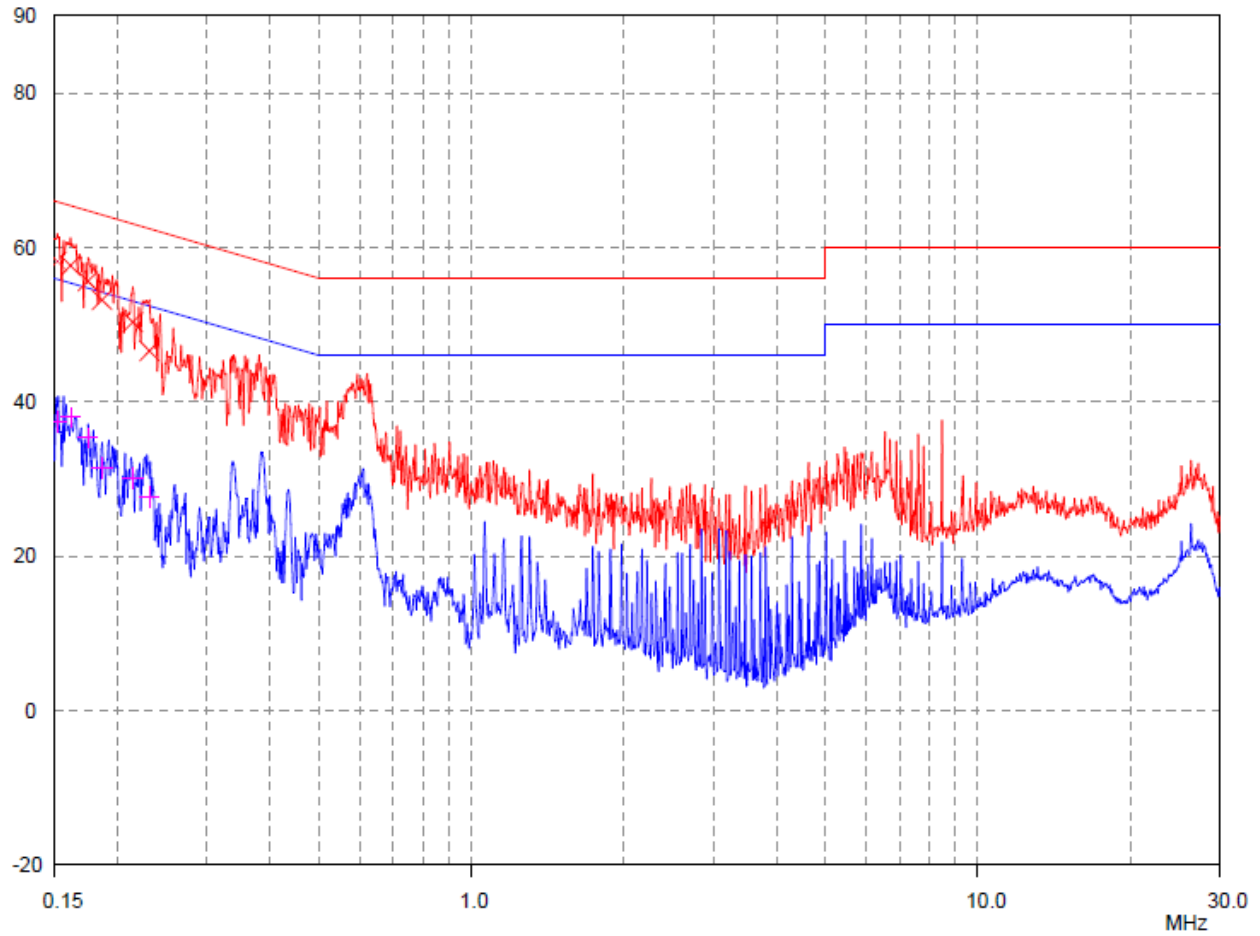

Test Data:

Frequency (MHz)	Quasi-peak			Average		
	level dB(μV)	Limit dB(μV)	Margin (dB)	level dB(μV)	limit dB(μV)	Margin (dB)
0.15	58.20	65.90	7.70	37.40	55.90	18.50
0.16	57.64	65.40	7.76	38.01	55.40	17.39
0.17	55.65	64.74	9.09	35.36	54.74	19.38
0.19	53.21	64.21	11.00	31.45	54.21	22.76
0.21	50.33	63.05	12.72	30.17	53.05	22.88
0.23	46.61	62.42	15.81	27.72	52.42	24.70

Remark: 1. Correct Factor = LISN Factor + Cable Loss, the value was added to Original Receiver Reading by the software automatically.

2. Corrected Reading = Original Receiver Reading + Correct Factor

3. Margin = Limit - Corrected Reading

4. If the PK Corrected Reading is lower than AV limit, the AV test can be elided.

TEST REPORT**9 Number of Hopping Frequencies**

Test result: Pass

9.1 Limit

Number of Hopping Frequencies in the 2400-2483.5 MHz band shall use at least 15 channels.

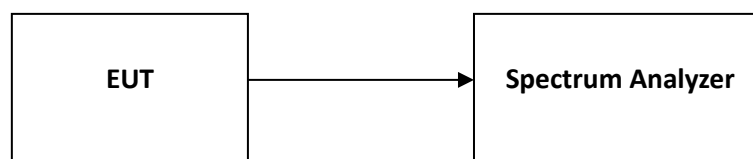
9.2 Test Configuration**9.3 Test procedure and test setup**

The EUT was tested according to Subclause 7.8 of ANSI C63.10.

The EUT shall have its hopping function enabled. Use the following spectrum analyzer settings:

- a) Span: The frequency band of operation. Depending on the number of channels the device supports, it may be necessary to divide the frequency range of operation across multiple spans, to allow the individual channels to be clearly seen.
- b) RBW: To identify clearly the individual channels, set the RBW to less than 30% of the channel spacing or the 20 dB bandwidth, whichever is smaller.
- c) VBW \geq RBW.
- d) Sweep: Auto.
- e) Detector function: Peak.
- f) Trace: Max hold.
- g) Allow the trace to stabilize.

9.4 Test Results of Number of Hopping Frequencies

Please refer to Appendix A

TEST REPORT

10 Dwell Time

Test result: Pass

10.1 Limit

The dwell time on any channel shall not be greater than 0.4 seconds within a period of 0.4 seconds multiplied by the number of hopping channels employed. Frequency hopping systems may avoid or suppress transmissions on a particular hopping frequency provided that a minimum of 15 channels are used.

10.2 Test Configuration

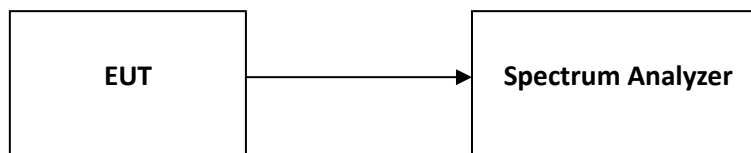

10.3 Test procedure and test setup

The EUT was tested according to Subclause 7.8 of ANSI C63.10.

The EUT shall have its hopping function enabled. Use the following spectrum analyzer settings:

- a) Span: Zero span, centered on a hopping channel.
- b) RBW shall be \leq channel spacing and where possible RBW should be set $\gg 1 / T$, where T is the expected dwell time per channel.
- c) Sweep: As necessary to capture the entire dwell time per hopping channel; where possible use a video trigger and trigger delay so that the transmitted signal starts a little to the right of the start of the plot. The trigger level might need slight adjustment to prevent triggering when the system hops on an adjacent channel; a second plot might be needed with a longer sweep time to show two successive hops on a channel.
- d) Detector function: Peak.
- e) Trace: Max hold.

Use the marker-delta function to determine the transmit time per hop. If this value varies with different modes of operation (data rate, modulation format, number of hopping channels, etc.), then repeat this test for each variation in transmit time.

Repeat the measurement using a longer sweep time to determine the number of hops over the period specified in the requirements. The sweep time shall be equal to, or less than, the period specified in the requirements. Determine the number of hops over the sweep time and calculate the total number of hops in the period specified in the requirements, using the following equation:
 (Number of hops in the period specified in the requirements) = (number of hops on spectrum analyzer) \times (period specified in the requirements / analyzer sweep time)

TEST REPORT

The average time of occupancy is calculated from the transmit time per hop multiplied by the number of hops in the period specified in the requirements. If the number of hops in a specific time varies with different modes of operation (data rate, modulation format, number of hopping channels, etc.), then repeat this test for each variation.

10.4 Test Results of Dwell Time

Please refer to Appendix A

TEST REPORT**11 Occupied Bandwidth****Test result:** **Tested****11.1 Limit**

None

11.2 Measurement Procedure

The EUT was tested according to Subclause 7.8 of ANSI C63.10 and RSS-Gen.

The span of the analyzer shall be set to capture all products of the modulation process, including the emission skirts.

The resolution bandwidth (RBW) shall be in the range of 1% to 5% of the occupied bandwidth (OBW) and video bandwidth (VBW) shall be approximately 3 x RBW.

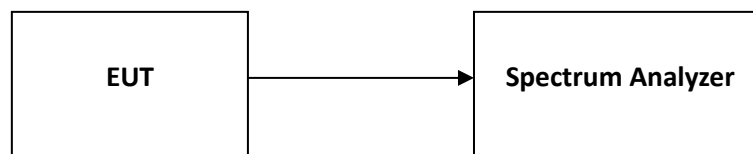
11.3 Test Configuration**11.4 The results of Occupied Bandwidth**

Please refer to Appendix A

TEST REPORT**12 Antenna requirement****Requirement:**

An intentional radiator shall be designed to ensure that no antenna other than that furnished by the responsible party shall be used with the device. The use of a permanently attached antenna or of an antenna that uses a unique coupling to the intentional radiator shall be considered sufficient to comply with the provisions of this section.

Result:

EUT uses permanently attached antenna to the intentional radiator, so it can comply with the provisions of this section.

TEST REPORT

Appendix A: Test results

1. Peak Output Power

1.1 Test Data

BT Maximum Output Power				
Mode	Test Frequency (MHz)	Packet Type	Power (dBm)	Result
GFSK	2402	DH5	2.20	Pass
GFSK	2441	DH5	4.76	Pass
GFSK	2480	DH5	5.00	Pass
DQPSK	2402	2DH5	1.29	Pass
DQPSK	2441	2DH5	3.78	Pass
DQPSK	2480	2DH5	4.07	Pass
8DPSK	2402	3DH5	1.54	Pass
8DPSK	2441	3DH5	4.11	Pass
8DPSK	2480	3DH5	4.43	Pass

TEST REPORT

1.2 Test Plots



TEST REPORT

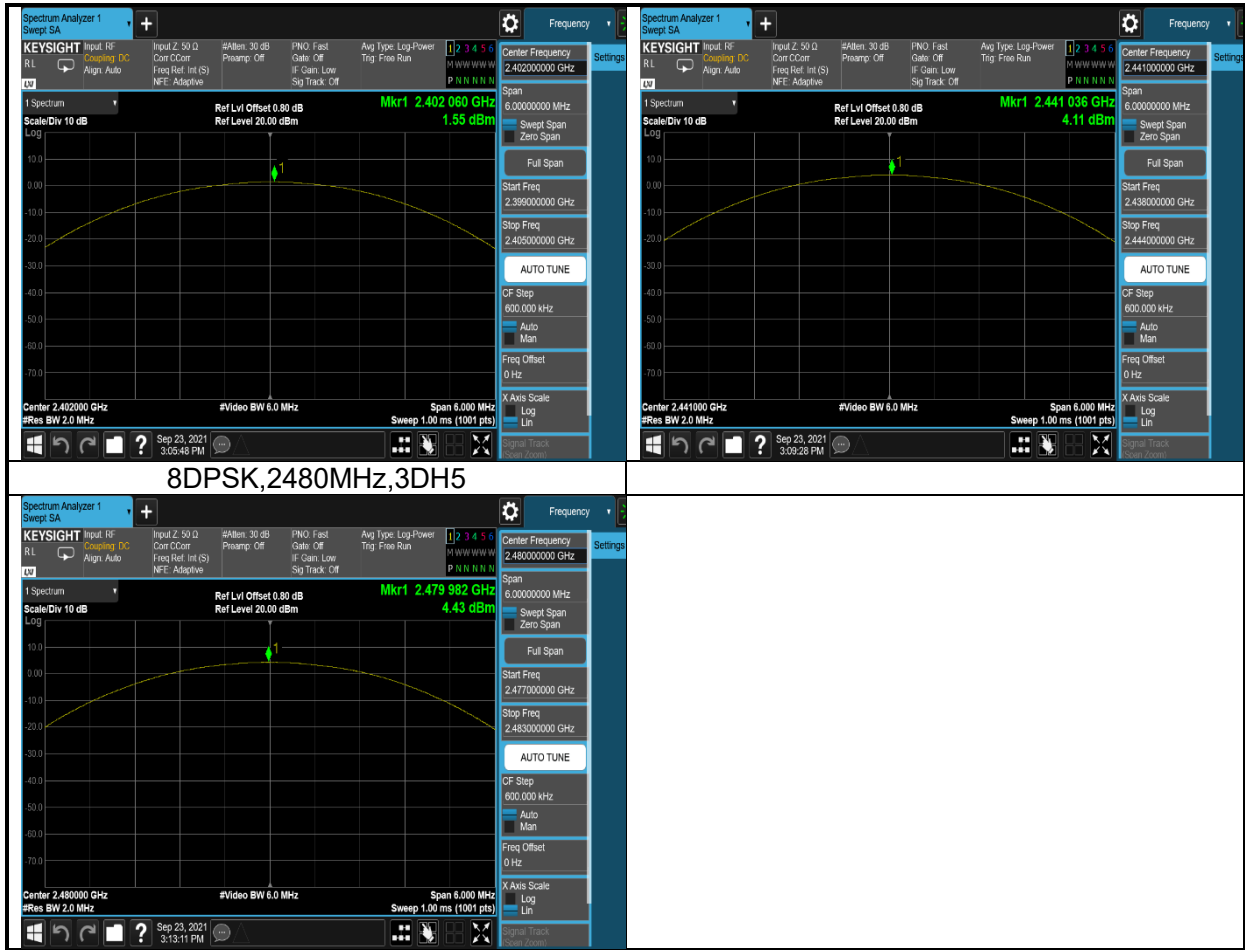

TEST REPORT

2. 20dB Bandwidth

2.1 Test Data

BT Occupied 20dB Bandwidth				
Mode	Test Frequency (MHz)	Packet Type	20dB Bandwidth (kHz)	Result
GFSK	2402	DH5	947.9	Pass
GFSK	2441	DH5	949.6	Pass
GFSK	2480	DH5	944.3	Pass
DQPSK	2402	2DH5	1351.4	Pass
DQPSK	2441	2DH5	1348.7	Pass
DQPSK	2480	2DH5	1350.9	Pass
8DPSK	2402	3DH5	1341.8	Pass
8DPSK	2441	3DH5	1343.6	Pass
8DPSK	2480	3DH5	1340.5	Pass

2.2 Test Plots

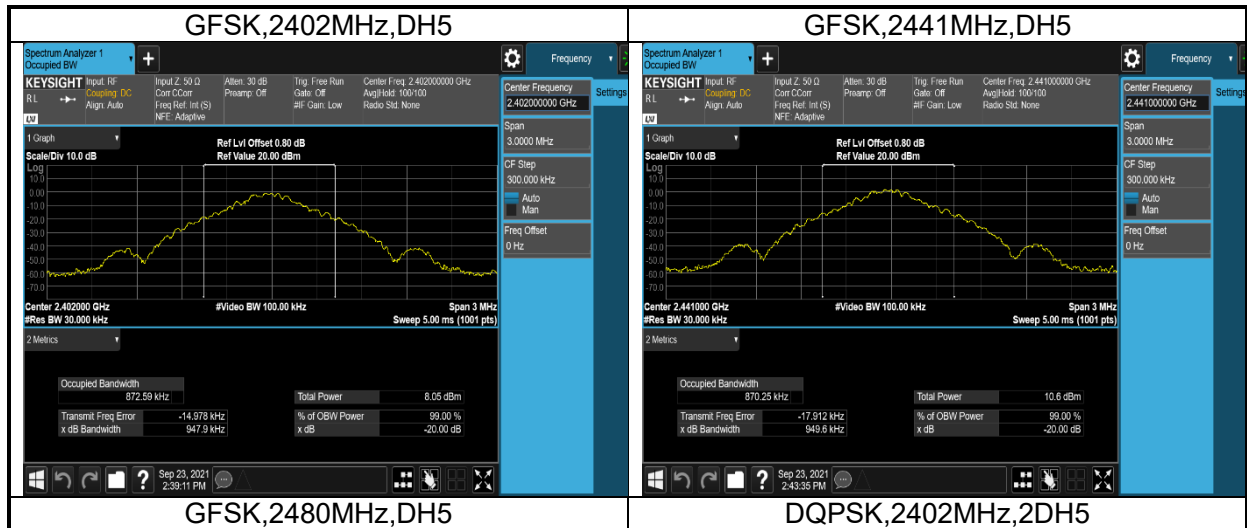

TEST REPORT

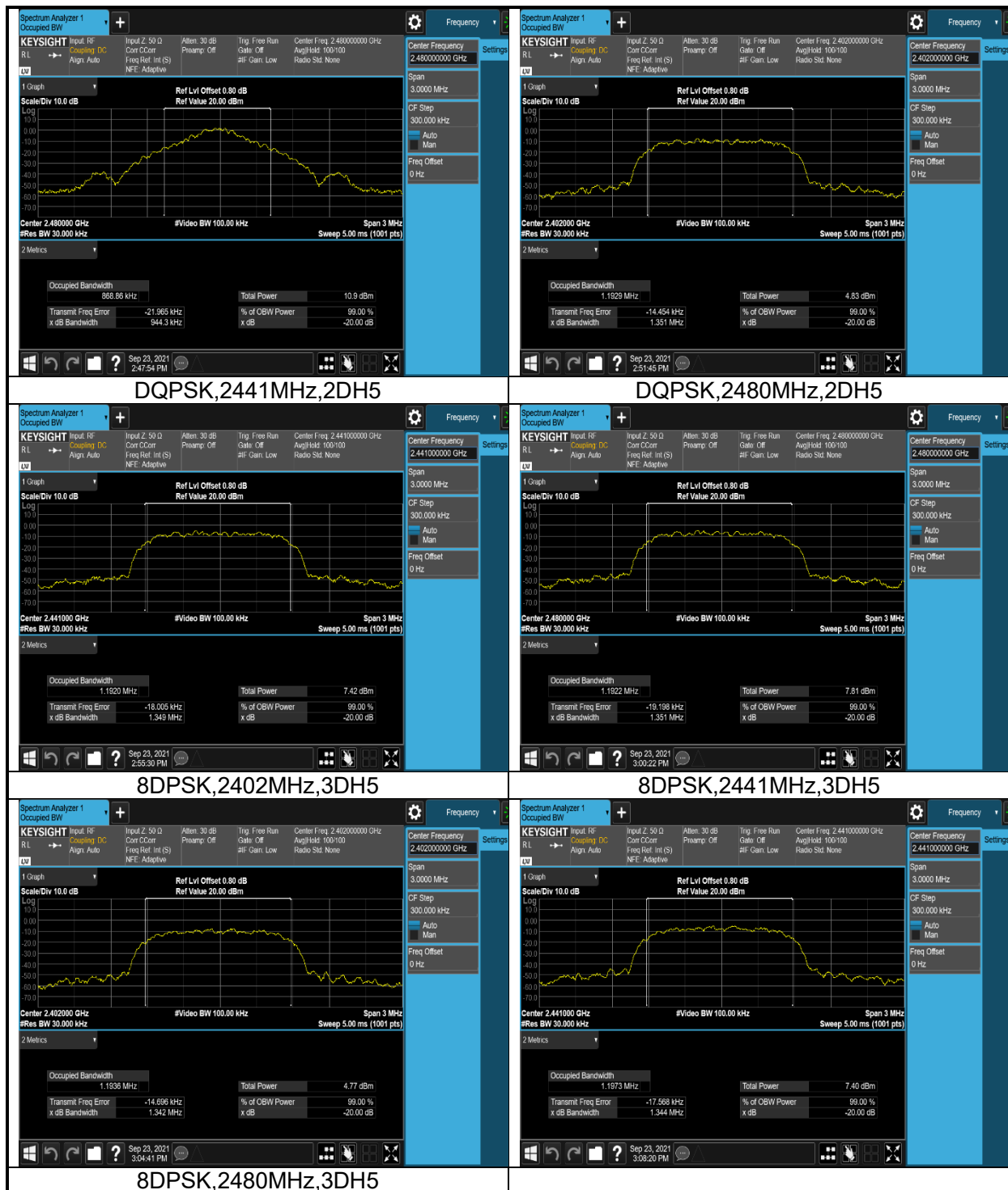

TEST REPORT



TEST REPORT

3. Occupied Bandwidth

3.1 Test Data

BT 99% Occupied Bandwidth				
Mode	Test Frequency (MHz)	Packet Type	99% Occupied Bandwidth (kHz)	Result
GFSK	2402	DH5	873.15	Pass
GFSK	2441	DH5	865.89	Pass
GFSK	2480	DH5	865.09	Pass
DQPSK	2402	2DH5	1193.49	Pass
DQPSK	2441	2DH5	1192.11	Pass
DQPSK	2480	2DH5	1191.54	Pass
8DPSK	2402	3DH5	1196.30	Pass
8DPSK	2441	3DH5	1196.72	Pass
8DPSK	2480	3DH5	1198.74	Pass

TEST REPORT

3.2 Test Plots

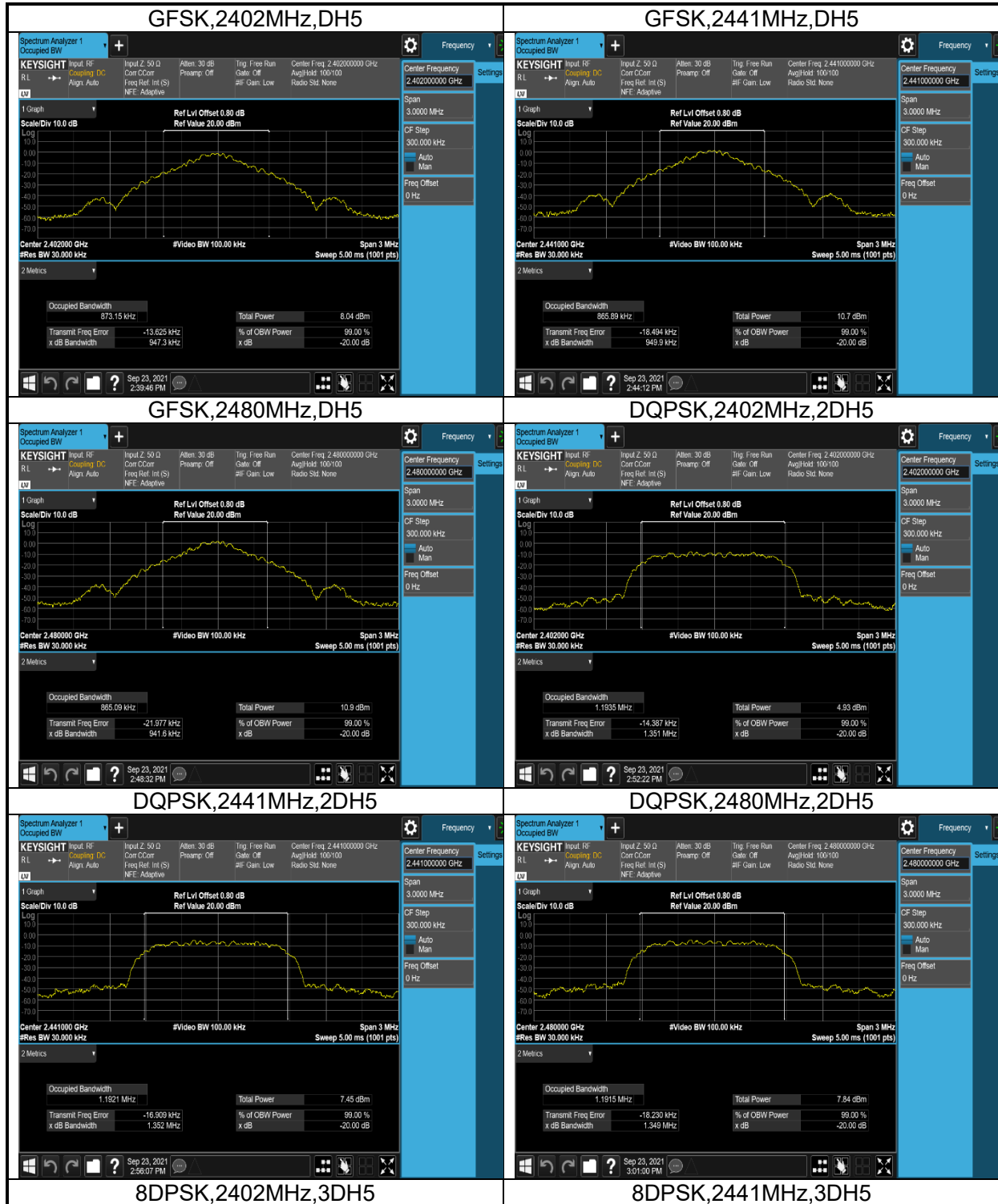

TEST REPORT

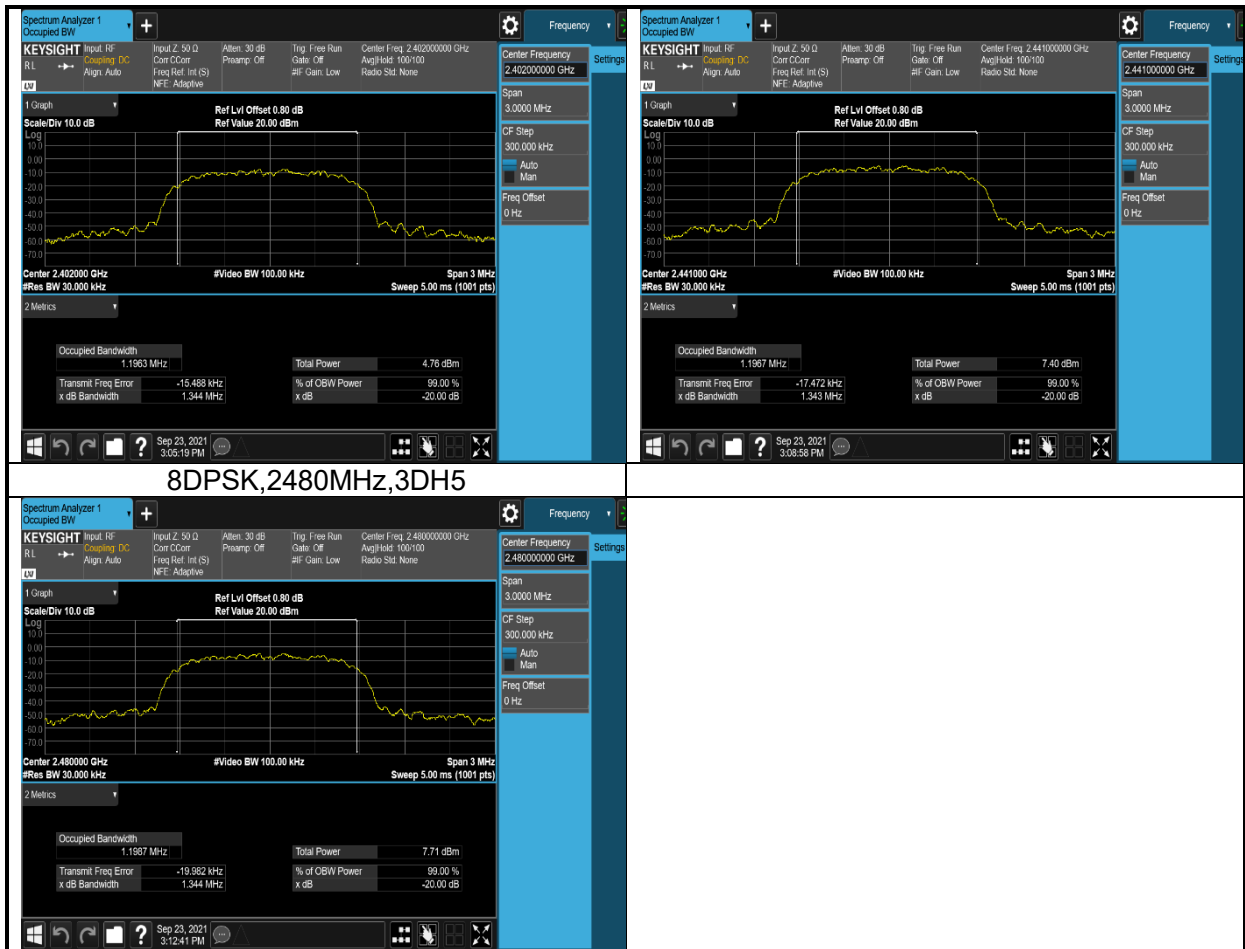

TEST REPORT

4. Conducted Spurious Emissions & Band Edge

4.1 Test Data

BT Transmitter Spurious Emission					
Mode	Test Frequency (MHz)	Packet Type	Frequency Range	Power (dBm)	Result
GFSK	2402	DH5	0.009MHz~2380MHz	-57.38	Pass
GFSK	2402	DH5	10000MHz~25000MHz	-49.94	Pass
GFSK	2402	DH5	2410MHz~10000MHz	-54.41	Pass
GFSK	2402	DH5	Band Edge	-57.79	Pass
GFSK	2441	DH5	0.009MHz~2300MHz	-58.22	Pass
GFSK	2441	DH5	10000MHz~25000MHz	-50.30	Pass
GFSK	2441	DH5	2500MHz~10000MHz	-54.30	Pass
GFSK	2441	DH5	Band Edge	-58.00	Pass
GFSK	2480	DH5	0.009MHz~2475MHz	-57.05	Pass
GFSK	2480	DH5	10000MHz~25000MHz	-50.16	Pass
GFSK	2480	DH5	2505MHz~10000MHz	-54.68	Pass
GFSK	2480	DH5	Band Edge	-58.93	Pass
DQPSK	2402	2DH5	0.009MHz~2380MHz	-55.46	Pass
DQPSK	2402	2DH5	10000MHz~25000MHz	-50.64	Pass
DQPSK	2402	2DH5	2410MHz~10000MHz	-54.98	Pass
DQPSK	2402	2DH5	Band Edge	-59.39	Pass
DQPSK	2441	2DH5	0.009MHz~2300MHz	-57.84	Pass
DQPSK	2441	2DH5	10000MHz~25000MHz	-50.76	Pass
DQPSK	2441	2DH5	2500MHz~10000MHz	-54.45	Pass
DQPSK	2441	2DH5	Band Edge	-58.83	Pass
DQPSK	2480	2DH5	0.009MHz~2475MHz	-57.37	Pass
DQPSK	2480	2DH5	10000MHz~25000MHz	-50.69	Pass
DQPSK	2480	2DH5	2505MHz~10000MHz	-53.72	Pass
DQPSK	2480	2DH5	Band Edge	-58.56	Pass
8DPSK	2402	3DH5	0.009MHz~2380MHz	-57.24	Pass
8DPSK	2402	3DH5	10000MHz~25000MHz	-50.02	Pass
8DPSK	2402	3DH5	2410MHz~10000MHz	-54.78	Pass

TEST REPORT

8DPSK	2402	3DH5	Band Edge	-58.45	Pass
8DPSK	2441	3DH5	0.009MHz~2300MHz	-57.51	Pass
8DPSK	2441	3DH5	10000MHz~25000MHz	-50.64	Pass
8DPSK	2441	3DH5	2500MHz~10000MHz	-55.15	Pass
8DPSK	2441	3DH5	Band Edge	-58.40	Pass
8DPSK	2480	3DH5	0.009MHz~2475MHz	-56.39	Pass
8DPSK	2480	3DH5	10000MHz~25000MHz	-50.53	Pass
8DPSK	2480	3DH5	2505MHz~10000MHz	-54.49	Pass
8DPSK	2480	3DH5	Band Edge	-58.62	Pass

4.2 Test Plots

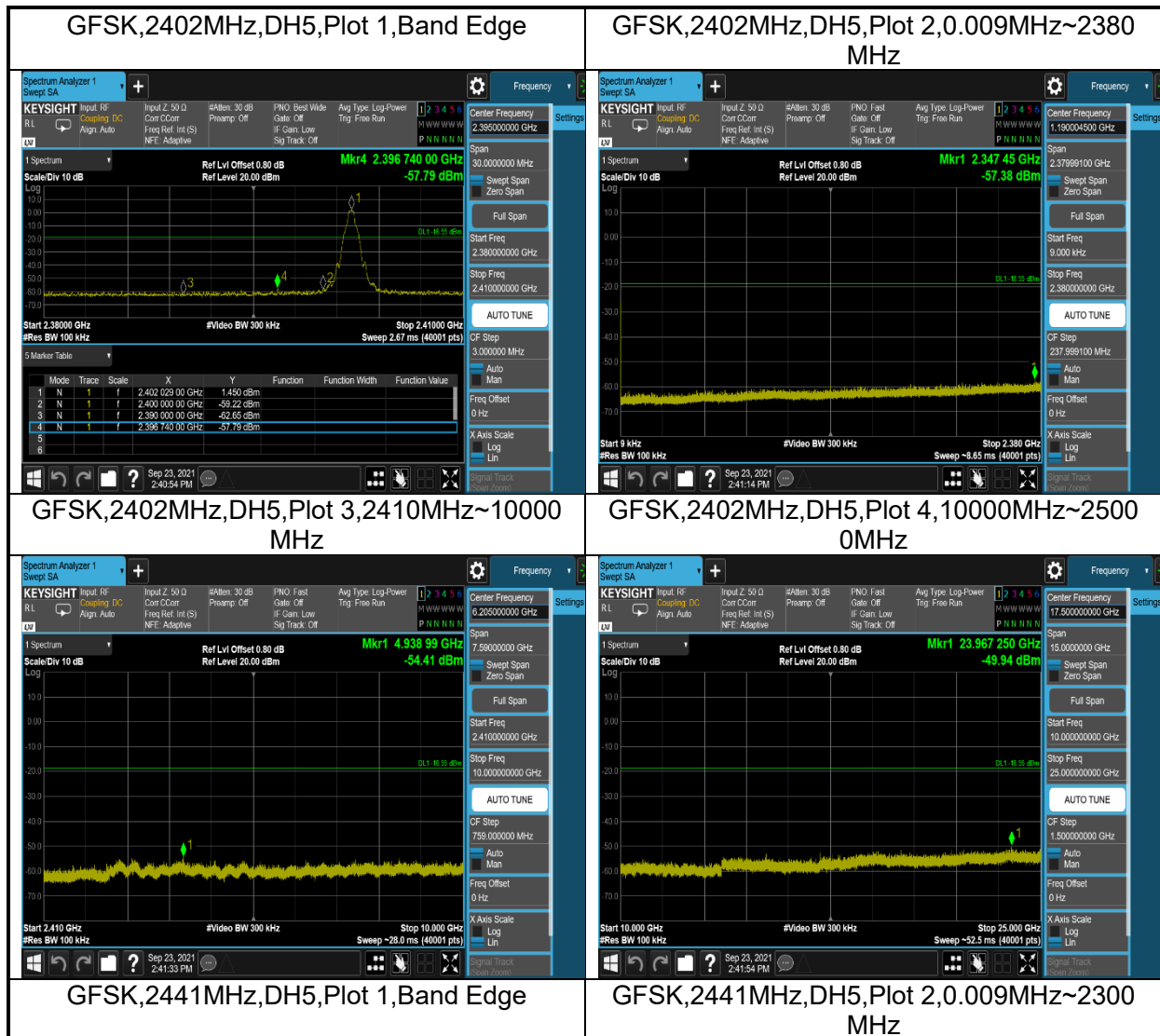

TEST REPORT



GFSK,2441MHz,DH5,Plot 3,2500MHz~10000 MHz

GFSK,2441MHz,DH5,Plot 4,10000MHz~2500 0MHz

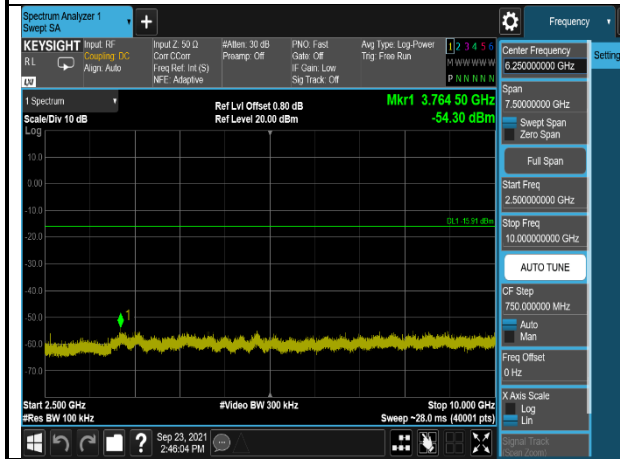

GFSK,2480MHz,DH5,Plot 1,Band Edge

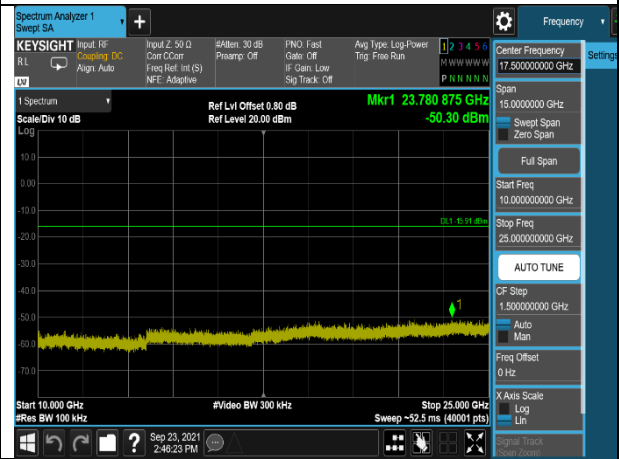

GFSK,2480MHz,DH5,Plot 2,0.009MHz~2475 MHz

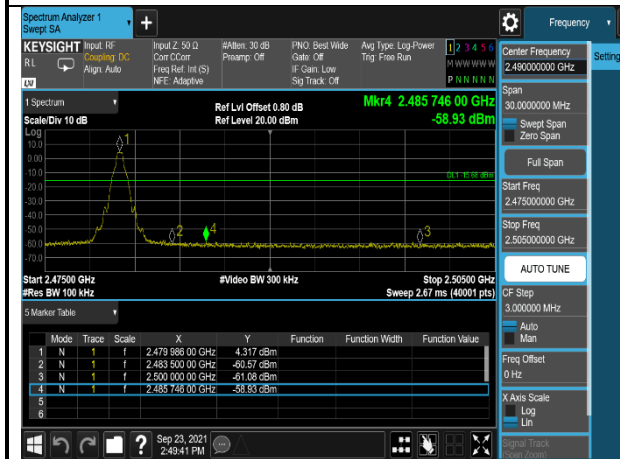

GFSK,2480MHz,DH5,Plot 3,2505MHz~10000 MHz

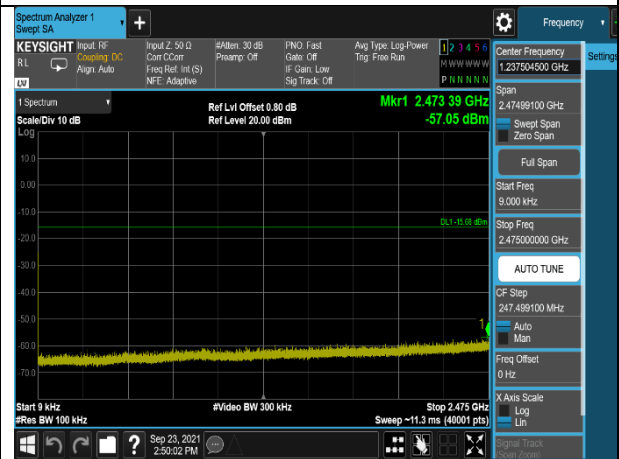

GFSK,2480MHz,DH5,Plot 4,10000MHz~2500 0MHz

TEST REPORT



DQPSK,2402MHz,2DH5,Plot 1,Band Edge

DQPSK,2402MHz,2DH5,Plot 2,0.009MHz~23.800MHz

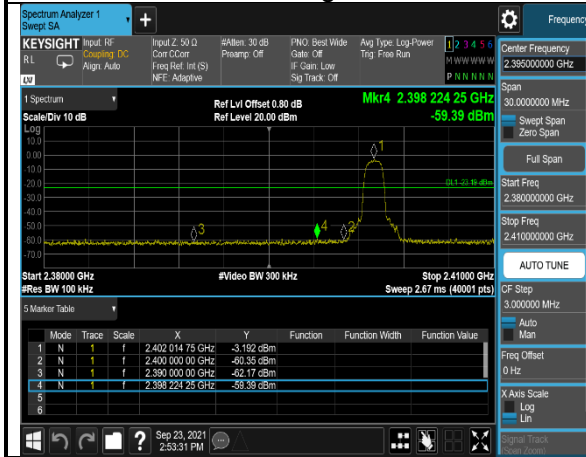

DQPSK,2402MHz,2DH5,Plot 3,2410MHz~100.000MHz

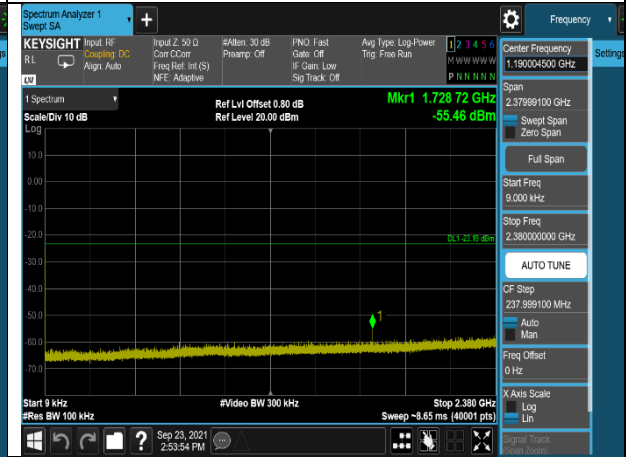

DQPSK,2402MHz,2DH5,Plot 4,10000MHz~25.000MHz

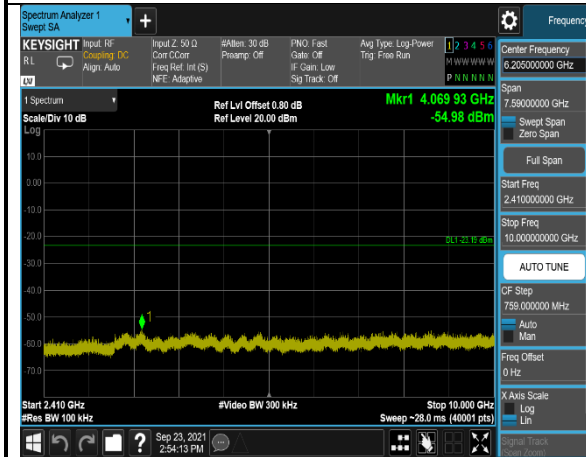

DQPSK,2441MHz,2DH5,Plot 1,Band Edge

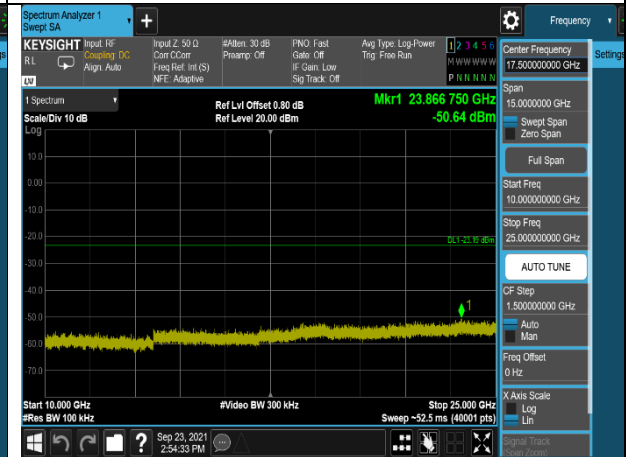

DQPSK,2441MHz,2DH5,Plot 2,0.009MHz~23.800MHz