

USER MANUAL

Please read this manual thoroughly before using and keep it for future reference.

FUNCTION OVERVIEW

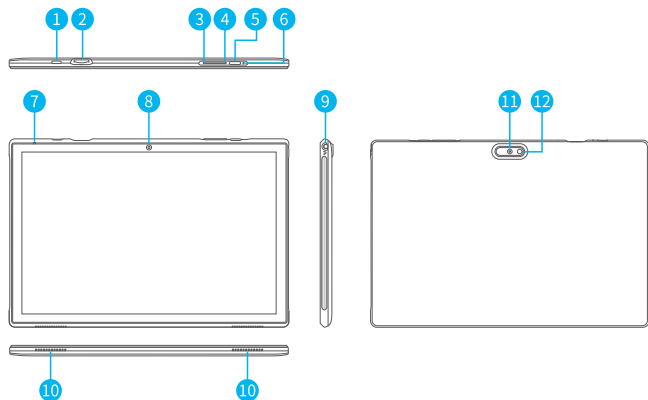

- | | | |
|---------------------|------------------------|-------------------|
| 1. USB-C Port | 5. Power On/Off | 9. Headphone Jack |
| 2. Memory Card Slot | 6. Reset (Reboot) | 10. Speakers |
| 3. Volume + | 7. Microphone | 11. Rear Camera |
| 4. Volume - | 8. Front-facing Camera | 12. Flash |

* Google, Android, Google Play and other marks are trademarks of Google LLC.

GETTING STARTED

Power On/Off

- * Press and hold the power button for 3-5s to turn on your tablet. Select your language and set up your tablet following the start guide.
- * Press and hold the power button for 2s, then release it. It will show **Power off** and **Restart** on the screen. Tap **Power off** to turn off the tablet.
- * Press and hold the power button for 7-8s to do a forced shutdown when it's frozen.

Battery

- * A rechargeable Li-ion battery is installed in the tablet.
- * DO NOT attempt to replace the tablet battery by yourself because you may damage the battery, which might cause overheating, fire or injury.
- * DO NOT dispose of tablet in a fire.
- * DO NOT expose the tablet battery to any heat source, direct sunlight or high temperature.
- * Only use the **ORIGINAL** power adapter provided by us to charge the tablet battery.
- * We suggest you drain the battery completely once a month if only use your tablet occasionally.
- * The Li-ion battery in your tablet should be serviced or recycled by an authorized service provider, and must be recycled or disposed of separately from household waste.
- * Dispose of battery according to your local environmental laws and regulations.

Sleep Mode

Simply press the power button once to switch the tablet to the **Sleep Mode** when the tablet is **ON**; press again to wake it up.

Tip:

Go to **Settings > Display > Screen timeout** to set the time of entering the **Sleep Mode**.

Screenshot

Press and hold the **Volume-** button and the **Power On/Off** button together to capture a picture.

HOME SCREEN

Icons on the Bottom Menu

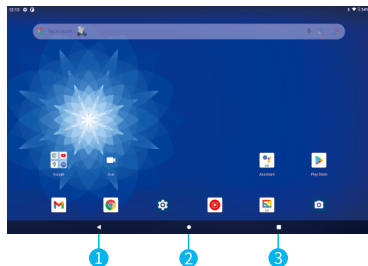

1. Back
2. Home Screen
3. Recent Activities

Home Settings, Widgets and Wallpapers

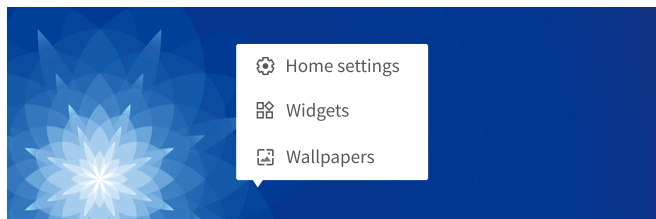

Tap and hold the empty section of a Home screen, **Home settings**, **Widgets** and **Wallpapers** will be displayed.

- * Tap **Home Settings** to enable/disable **Add icon to Home screen**. This is applicable to the new Apps installed from **Play Store**.
- * Tap **Widgets**, touch and hold any application (e.g. Clock), then slide and add it to a Home screen. Remove it by sliding it to **X Remove**.
- * Tap **Wallpapers** to change the current wallpaper of the tablet from the default wallpapers or your photos.

SETTING BASICS

Quick Settings

Swipe down from the top of the screen to access **Quick Settings**.

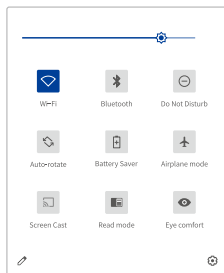
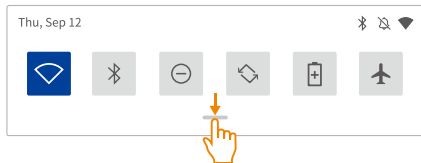

 : **WiFi**. Tap to connect/disconnect to a wireless network

 : **Bluetooth**. Enable/disable the Bluetooth of the tablet

 : **Do Not Disturb**. Block sound after enabling this function

 : **Auto-rotate**. Turn on/off the **Auto-rotate** of the screen

 : **Battery Saver**. Tap to choose the power setting you prefer to save the battery time

 : **Airplane Mode**. Turn on/off all the network connectivity

 : **Screen Cast**. Mirror the display of the tablet to compatible devices, e.g. TV box or Fire TV Stick.

 : **Read mode**. The screen will be black and white after enabling this option

 : **Eye comfort**. Enable/disable the eye protection mode

Tap the  icon to change the options in the **Quick Settings**. Long press each icon to enter the interface of its detailed settings.

More Settings

Swipe down from the top of the screen, then tap the  icon to enter the detailed setting interface. Or, tap the **Settings App** on the Home screen to enter.

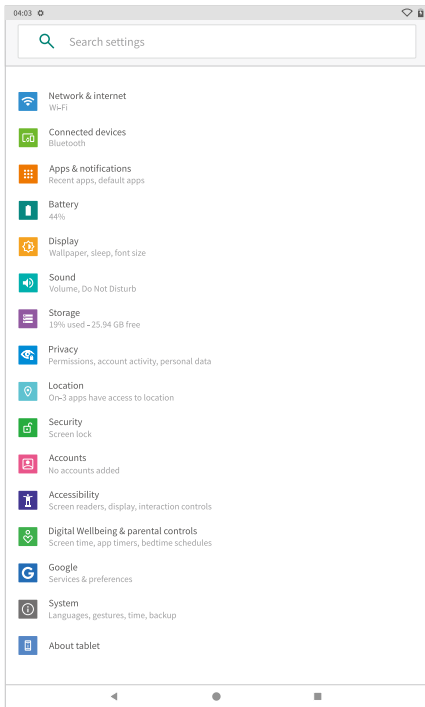

Network & internet

- * Connect to any working Wifi
- * Enable/disable the **Airplane Mode**
- * Add VPN Connections
- * Select a private DNS mode

Connected devices

- * Pair with Bluetooth devices and check the paired devices
- * Turn on/off Bluetooth
- * Check the connection status of the cast devices
- * Add and check printers
- * Check the received files from other devices via bluetooth connection and more

Apps & notifications

- * Check the Apps recently opened
- * Check all the Apps on the tablet
- * Clear the cache of the Apps
- * Uninstall the third-party Apps
- * Adjust App notification settings
- * Check priority and modified conversations
- * Check the screen time for Apps
- * Set default apps
- * Set the App permissions and more

Battery

- * Enable/disable **Battery percentage** and **Battery Manager**
- * Display or hide the remaining power as a percentage
- * Check the time for **Last full charge** and **Screen usage since full charge**

Display

- * Adjust the screen brightness
- * Enable/disable the **Dark theme**
- * Turn on/off **Eye comfort**
- * Change the wallpaper
- * Adjust the time of entering the sleep mode
- * Turn on/off the auto-rotation of the screen
- * Adjust the font size and display size
- * Set a screen saver

- * Set what to show when the tablet is locked and more

Sound

- * Set sound level for **Media, Alarm** and **Notification**
- * Enable/disable **Do Not Disturb** to mute sound and stop vibration
- * Show/hide the media player when the media session has ended
- * Set default notification sound and alarm sound
- * Enable/disable **Screen locking sound** and **Touch sounds**

Storage

- * View and manage your storage space

Privacy

- * Set app permissions
- * Set to show/hide the password when input a password
- * Set the **Lock screen** preferences
- * Set what to show when the tablet is locked
- * Add an account and autofill service from google and more

Location

- * Turn on/off the location services for specific Apps
- * Set apps that have access to location
- * Enable/disable **Wifi and Bluetooth scanning** and more

Security

- * Check the security status
- * Set screen lock pattern, e.g. Password, PIN, Swipe etc.
- * Choose a **Smart Lock** to keep the device unlocked if you preset a lock pattern
- * Allow the admin apps to **Find My Device** and lock or erase a lost device and more

Accounts

- * Add and manage the user accounts on your tablet

Accessibility

- * For vision and hearing impaired users, manage settings for **SCREEN READERS**, **DISPLAY**, **INTERACTION CONTROLS**, **AUDIO & ON-SCREEN TEXT** and **EXPERIMENTAL**

Digital Wellbeing & parental controls

- * Check your app usage based on **Screen time**, **Notifications received**, or **Times opened** from **Dashboard**
- * Manage the related notification settings to reduce interruptions
- * Set up **Parental controls** to help your kids balance their screen time and more

Google

- * Set the preferences for Google™ related services

System

- * Set Language
Tap **Languages & input > Languages > +Add a language** to add your language. After adding, hold and slide the **≡** to the top to change the language
- * Set gestures of using the tablet
- * Set the date and time
- * Turn on/off the **Back up to Google Drive**
- * Restore factory setting
Tap **Reset options > Erase all data (factory reset)** to restore the factory setting
- * Check and update the tablet's system

About tablet

- * Check the detailed information about the tablet

NETWORK CONNECTION

Wifi Connection

Go to network settings from the **Settings** App or by long pressing the Wifi icon in **Quick Settings**.

1. Tap **Network & internet** and turn on the **WiFi**. All the WiFi connections available will be listed.
2. Select your WiFi and input the correct password.

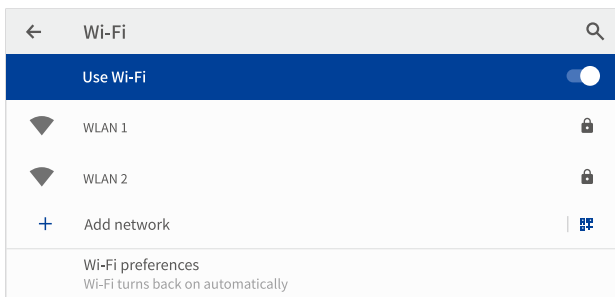
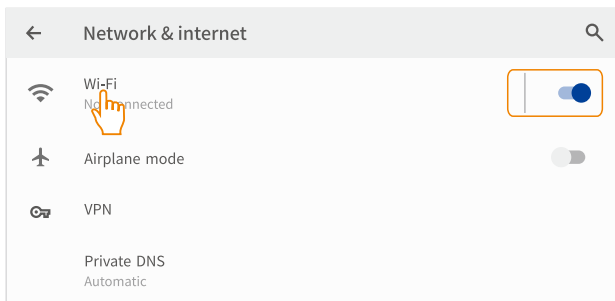

Bluetooth Pairing

Launch the App **Settings** and go to **Connected devices**, or long press the Bluetooth icon in **Quick Settings**.

1. Tap **+Pair new device** to enter the scanning interface. Devices available will be displayed after a few seconds.
2. Tap the desired device to get a pairing code and click **PAIR** on both devices. The automatic connection is applied to some devices.

APP MANAGEMENT

App Download and Installation

1. Tap and open **Play Store** on the Home screen.
2. Log into your google account, search and download the App you need.

App Management

Move the App

Tap and hold the App, then slide it to a desired screen.

Remove the App from the Home screen

Touch and hold the App, then slide to **X Remove** to remove it from your Home screen.

Uninstall the App

Touch and hold the App, then slide to the  **Uninstall** to uninstall the App.

Clear the Cache of the App

1. Go to **Settings > Apps & notifications**.
2. Select an App > **Storage & cache > CLEAR CACHE** to clear the cache.

INTERNET NAVIGATION

Please make sure the tablet is connected to a working WiFi network before navigating the Internet.

You may use the pre-installed Chrome browser or use another browser downloaded from Play Store.

MULTIMEDIA

Connecting to a Computer

1. Connect your tablet to the computer with a USB cable.
2. **File Transfer** is the default setting. Go to your computer and find your tablet to transfer files between your tablet and computer.

Tips:

Go to **Quick Settings**, tap **Android System · USB file transfer turned on > Tap for more options > USB Preferences** to select the option preferred.

- * Select **MIDI** to play MIDI instruments on the tablet.
- * Select **PTP** to transfer photos between the devices.
- * Select **No data transfer** to charge your tablet.

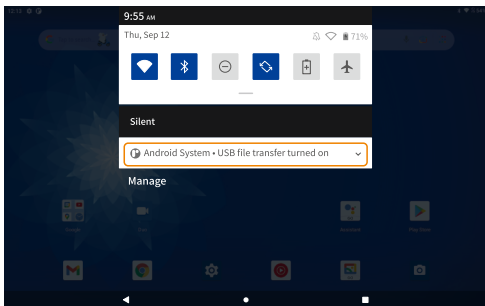

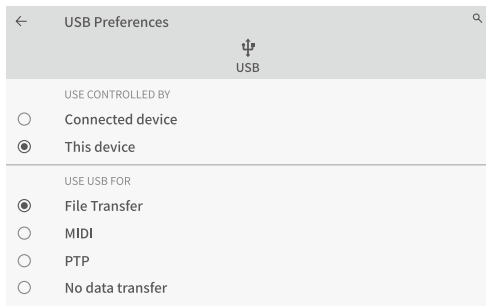
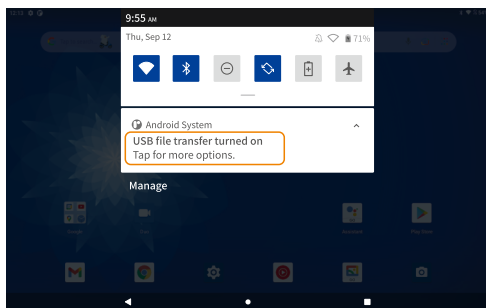

Connecting to an External Device

1. Install a memory card (up to 512GB) into the memory card slot when the tablet is off.

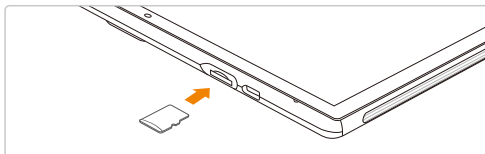

2. Turn on the tablet, then go to **Quick Settings** and select **Tap to set up**.
3. Set the memory card as a portable storage by selecting **Portable storage**. Enter memory card storage to move files between the card and tablet.

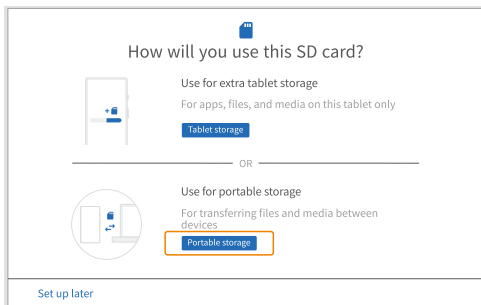
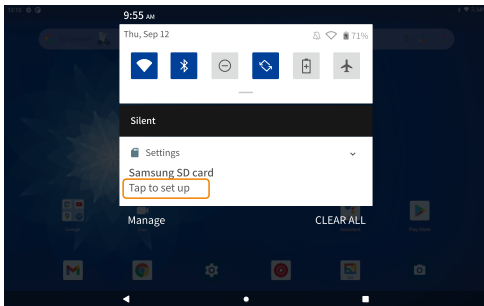

TROUBLESHOOTING

Q1. The tablet doesn't power on.

- * Reboot your tablet after charging for more than 30 minutes.
- * Press the power button to check if the tablet is in the **Sleep Mode**.
- * Insert a pin to the **Reset Hole** to reboot it.

Q2. The tablet doesn't charge.

- * Make sure the USB cable is properly plugged into the charging port.
- * Try another compatible USB cable and adapter.

Q3. Error message occurs during the operation.

- * Uninstall the App with the error message, then download and install again.
- * Insert the pin into the **Reset Hole** to reboot it.

Q4. The tablet cannot be detected by the computer.

- * Make sure the tablet is powered on.
- * Try another USB cable.
- * Try another USB port on the computer.
- * Instead of **No data transfer**, choose **File Transfer** or **PTP** when connecting the tablet to the computer.

Q5. The tablet cannot connect to the WiFi.

- * Make sure the **WiFi** in your tablet is **ON**.
- * Make sure you input the correct password when connecting the WiFi.
- * Restart the router.
- * Make sure there is no filter setting or device connection limitation in the setting of the router.
- * Forget the current Wifi, reset the router and connect the Wifi again.

Q6. The storage space of the tablet is not enough.

- * Delete the Apps you don't use.
- * Clear the cache of the Apps regularly.
- * Install a memory card to expand the storage.

Q7. The tablet comes with scratches on the screen.

* Check if the scratches are on the film. If yes, please remove the film.

Q8. The screen is unresponsive.

* Check if the screen is dusty or greasy. If yes, please gently wipe the screen with a cloth to clean it.

Q9. The font size is too small to read.

* Please go to **Settings > Display > Advanced > Font Size** to adjust the text size.

Q10. How to use your voice to search a fact?

* Tap the microphone icon on Google Search bar, tell the tablet what you want to know and it will show you the search results.

FCC Caution

Any Changes or modifications not expressly approved by the party responsible for compliance could void the user's authority to operate the equipment.

This device complies with part 15 of the FCC Rules. Operation is subject to the following two conditions: (1) This device may not cause harmful interference, and (2) this device must accept any interference received, including interference that may cause undesired operation. This equipment complies with FCC radiation exposure limits set forth for an uncontrolled environment.

Note:

This equipment has been tested and found to comply with the limits for a Class B digital device, pursuant to part 15 of the FCC Rules. These limits are designed to provide reasonable protection against harmful interference in a residential installation. This equipment generates, uses and can radiate radio frequency energy and, if not installed and used in accordance with the instructions, may cause harmful interference to radio communications. However, there is no guarantee that interference will not occur in a particular installation. If this equipment does cause harmful interference to radio or television reception, which can be determined by turning the equipment off and on, the user is encouraged to try to correct the interference by one or more of the following measures:

- Reorient or relocate the receiving antenna.
- Increase the separation between the equipment and receiver.
- Connect the equipment into an outlet on a circuit different from that to which the receiver is connected.
- Consult the dealer or an experienced radio/TV technician for help.

This transmitter must not be co-located or operating in conjunction with any other antenna or transmitter.

FCC Radiation Exposure Statement:

The device has been tested and comply with FCC SAR limits

ISED Requirements

This device complies with Innovation, Science, and Economic Development Canada licence-exempt RSS standard(s). Operation is subject to the following two conditions:

- (1) this device may not cause interference, and
- (2) this device must accept any interference, including interference that may cause undesired operation of the device.

Le présent appareil est conforme aux CNR d' Innovation, Sciences et Développement économique Canada applicables aux appareils radio exempts de licence. L'exploitation est autorisée aux deux conditions suivantes :

- (1) l'appareil n' doit pas produire de brouillage, et
- (2) l'utilisateur de l'appareil doit accepter tout brouillage radioélectrique subi, même si le brouillage est susceptible d'en compromettre le fonctionnement.

The device has been tested and comply with IC SAR limits.

L'appareil a été testé et est conforme aux limites IC SAR.

Operation of this device in the band 5150-5250 MHz is restricted to indoor use only.

Le fonctionnement de cet appareil dans la bande 5150-5250 MHz est limité à une utilisation en intérieur uniquement.

This transmitter must not be co-located or operating in conjunction with any other antenna or transmitter.

Cet émetteur ne doit pas être colocalisé ou fonctionner en conjonction avec une autre antenne ou un autre émetteur.

The device has been tested and comply with IC SAR limits. L'appareil a été testé et est conforme aux limites IC SAR.

Notes:



1. High Sound Pressure
2. Hearing Damage Risk
3. Do not listen at high volume levels for long periods.