



中认信通
CHINA CERTIFICATION ICT CO., LTD (DONGGUAN)



TEST REPORT

Applicant: Shenzhen Junge Yunchuang Technology Co., Ltd.

Address: FCC:1204, Unit 3, Building C, Fu Cui Yuan, Fu Cui Road, Fu Cui Community, Xixiang St, Shenzhen, China
IC:1204, Unit 3, Building C, Fu Cui Yuan, Fu Cui Road, Fu Cui Community, Xixiang St. Shenzhen Guangdong 518000 China

FCC ID: 2A3FP-P03

IC: 27915-P03

HVIN: P03

Product Name: projector

**Standard(s): 47 CFR Part 15, Subpart C(15.247)
RSS-247 Issue 2, February 2017
RSS-Gen, Issue 5, February 2021 Amendment 2
ANSI C63.10-2013
KDB 558074 D01 15.247 Meas Guidance v05r02**

The above equipment has been tested and found compliance with the requirement of the relative standards by China Certification ICT Co., Ltd (Dongguan)

Report Number: CR21110068-00A

Date Of Issue: 2021-12-06

Reviewed By: Sun Zhong

Sun Zhong

Title: Manager

Test Laboratory: China Certification ICT Co., Ltd (Dongguan)

No. 113, Pingkang Road, Dalang Town, Dongguan,
Guangdong, China
Tel: +86-769-82016888

Test Facility

The Test site used by China Certification ICT Co., Ltd (Dongguan) to collect test data is located on the No. 113, Pingkang Road, Dalang Town, Dongguan, Guangdong, China.

The lab has been recognized as the FCC accredited lab under the KDB 974614 D01 and is listed in the FCC Public Access Link (PAL) database, FCC Registration No. : 442868, the FCC Designation No. : CN1314.

The lab has been recognized by Innovation, Science and Economic Development Canada to test to Canadian radio equipment requirements, the CAB identifier: CN0123.

Declarations

China Certification ICT Co., Ltd (Dongguan) is not responsible for the authenticity of any test data provided by the applicant. Data included from the applicant that may affect test results are marked with a triangle symbol “▲”. Customer model name, addresses, names, trademarks etc. are not considered data.

Unless otherwise stated the results shown in this test report refer only to the sample(s) tested.

This report cannot be reproduced except in full, without prior written approval of the Company.

This report is valid only with a valid digital signature. The digital signature may be available only under the Adobe software above version 7.0.

This report may contain data that are not covered by the accreditation scope and shall be marked with an asterisk “★”.

CONTENTS

TEST FACILITY	2
DECLARATIONS.....	2
1. GENERAL INFORMATION	5
1.1 PRODUCT DESCRIPTION FOR EQUIPMENT UNDER TEST (EUT)	5
1.2 DESCRIPTION OF TEST CONFIGURATION.....	7
1.2.2 Support Equipment List and Details	7
1.2.3 Support Cable List and Details	7
1.2.4 Block Diagram of Test Setup.....	8
1.3 MEASUREMENT UNCERTAINTY	10
2. SUMMARY OF TEST RESULTS	11
3. REQUIREMENTS AND TEST PROCEDURES	12
3.1 AC LINE CONDUCTED EMISSIONS.....	12
3.1.1 Applicable Standard.....	12
3.1.2 EUT Setup.....	14
3.1.3 EMI Test Receiver Setup	14
3.1.4 Test Procedure	15
3.1.5 Corrected Amplitude & Margin Calculation.....	15
3.2 RADIATION SPURIOUS EMISSIONS.....	16
3.2.1 Applicable Standard.....	16
3.2.2 EUT Setup.....	16
3.2.3 EMI Test Receiver & Spectrum Analyzer Setup	17
3.2.4 Test Procedure	18
3.2.5 Corrected Amplitude & Margin Calculation.....	18
3.3 6 DB EMISSION BANDWIDTH:.....	19
3.3.1 Applicable Standard.....	19
3.3.2 EUT Setup.....	19
3.3.3 Test Procedure	19
3.4 99% OCCUPIED BANDWIDTH:	20
3.4.1 Applicable Standard.....	20
3.4.2 EUT Setup.....	20
3.4.3 Test Procedure	20
3.5 MAXIMUM CONDUCTED OUTPUT POWER:.....	21
3.5.1 Applicable Standard.....	21
3.5.2 EUT Setup.....	21
3.5.3 Test Procedure	21
3.6 MAXIMUM POWER SPECTRAL DENSITY:	22
3.6.1 Applicable Standard.....	22
3.6.2 EUT Setup.....	22
3.6.3 Test Procedure	22
3.7 100 KHZ BANDWIDTH OF FREQUENCY BAND EDGE:	23
3.7.1 Applicable Standard.....	23

3.7.2 EUT Setup.....	23
3.7.3 Test Procedure	23
3.8 DUTY CYCLE:.....	24
3.8.1 EUT Setup.....	24
3.8.2 Test Procedure	24
3.9 ANTENNA REQUIREMENT.....	25
3.9.1 Applicable Standard.....	25
3.9.2 Judgment.....	25
4. Test DATA AND RESULTS	26
4.1 AC LINE CONDUCTED EMISSIONS.....	26
4.2 RADIATION SPURIOUS EMISSIONS.....	29
4.3 6 DB EMISSION BANDWIDTH:.....	38
4.4 99% OCCUPIED BANDWIDTH:	43
4.5 MAXIMUM PEAK CONDUCTED OUTPUT POWER:.....	48
4.6 MAXIMUM POWER SPECTRAL DENSITY:	49
4.7 100 KHZ BANDWIDTH OF FREQUENCY BAND EDGE:	54
4.8 DUTY CYCLE:.....	59
5. RF EXPOSURE EVALUATION	61
5.1 MAXIMUM PERMISSIBLE EXPOSURE (MPE)	61
5.1.1 APPLICABLE STANDARD.....	61
5.1.2 PROCEDURE.....	61
5.1.3 CALCULATED RESULT	61
5.2 EXEMPTION LIMITS FOR ROUTINE EVALUATION – RF EXPOSURE EVALUATION	62
5.2.1 APPLICABLE STANDARD.....	62
5.2.2 CALCULATED RESULT	62

1. GENERAL INFORMATION

1.1 Product Description for Equipment under Test (EUT)

EUT Name:	projector
EUT Model:	Leisure 3
FCC Multiple Models:	Leisure 3W,Leisure 3PRO,Leisure D30T, B211,B212,B213,B214,B215,C216,C217,C218,C219,C220,C221,C222,C 223,C224,C225,C226,C227,C228,C229,C230,C231,C232,D206,D207,D2 08,D209,D210,Q5
IC Multiple Models:	Leisure 3W,Leisure 3PRO,Leisure D30T,B211,B212,C216,C217,C218, D206,D207,Q5
Operation Frequency:	2412-2462 MHz(802.11b/g/n ht20), 2422-2452 MHz(802.11n ht40)
Maximum Peak Output Power (Conducted):	24.02 dBm(802.11b/g/n)
Modulation Type:	DSSS, OFDM(802.11b/g/n)
Rated Input Voltage:	AC 120V/60Hz
Serial Number:	CR21110068-RF-S1
EUT Received Date:	2021.11.16
EUT Received Status:	Good
Note: The Multiple models are identical with the test model, please refer to the declaration letter for more detail, which was provided by manufacturer.	

Operation Frequency Detail:

For 802.11b/g/n ht20:

Channel	Frequency (MHz)	Channel	Frequency (MHz)
1	2412	7	2442
2	2417	8	2447
3	2422	9	2452
4	2427	10	2457
5	2432	11	2462
6	2437	/	/

Per section 15.31(m), the lowest frequency, middle frequency, and highest frequency were performed the test as below:

Test Channel	Frequency (MHz)
Lowest	2412
Middle	2437
Highest	2462

For 802.11n ht40:

Channel	Frequency (MHz)	Channel	Frequency (MHz)
3	2422	7	2442
4	2427	8	2447
5	2432	9	2452
6	2437	/	/

Per section 15.31(m), the lowest frequency, middle frequency, and highest frequency were performed the test as below:

Test Channel	Frequency (MHz)
Lowest	2422
Middle	2437
Highest	2452

Antenna Information Detail▲:

Antenna Manufacturer	Antenna Type	input impedance (Ohm)	Antenna Gain /Frequency Range	§15.203& RSS-Gen Requirement
Shenzhen Junge Yunchuang Technology Co., Ltd.	FPC	50	-1.8 dBi/ 2.4~2.5GHz	Compliance

The Method of §15.203 Compliance:

- Antenna must be permanently attached to the unit.
 Antenna must use a unique type of connector to attach to the EUT.
 Unit must be professionally installed, and installer shall be responsible for verifying that the correct antenna is employed with the unit.

Accessory Information:

Accessory Description	Manufacturer	Model	Parameters
Power Cable	VanTop	Unknown	Un-shielding, 1.2m
AV Cable	VanTop	Unknown	Un-shielding, 1.2m

1.2 Description of Test Configuration

1.2.1 EUT Operation Condition:

EUT Operation Mode:	The system was configured for testing in Engineering Mode, which was provided by the manufacturer.			
Equipment Modifications:	No			
EUT Exercise Software:	realtek 11n 8188GTV USB WLAN MP Diagnostic Program 0.01.20171211			
The software was provided by manufacturer. The maximum power was configured as below, that was provided by the manufacturer ▲ :				
Test Modes	Data Rate	Power Level Setting		
		Lowest Channel	Middle Channel	Highest Channel
802.11b	1Mbps	32	32	32
802.11g	6Mbps	38	38	38
802.11n ht20	MCS0	36	36	36
802.11n ht40	MCS0	33	33	33
The above are the worst-case data rates, which are determined for each mode based upon investigations by measuring the average power and PSD across all data rates, bandwidths, and modulations.				

1.2.2 Support Equipment List and Details

Manufacturer	Description	Model	Serial Number
DELL	Laptop	D610	3Z5GP71
GIEC	DVD	BDP-G4350	BD43504KXM21041500221
kingston	U Disk	SD40G	sds
HUAWEI	Earphone	S1	SA1
SanDisk	TF card	UHS-I-16G	9292DVDSV0XZ

1.2.3 Support Cable List and Details

Cable Description	Shielding Type	Ferrite Core	Length (m)	From Port	To
VGA Cable	Yes	Yes	1.5	EUT	Laptop
HDMI	Yes	Yes	1.5	DVD	EUT
AV Cable	No	No	1.2	DVD	EUT
Earphone cable	No	No	1.2	EUT	Earphone

1.2.4 Block Diagram of Test Setup

AC line conducted emissions:

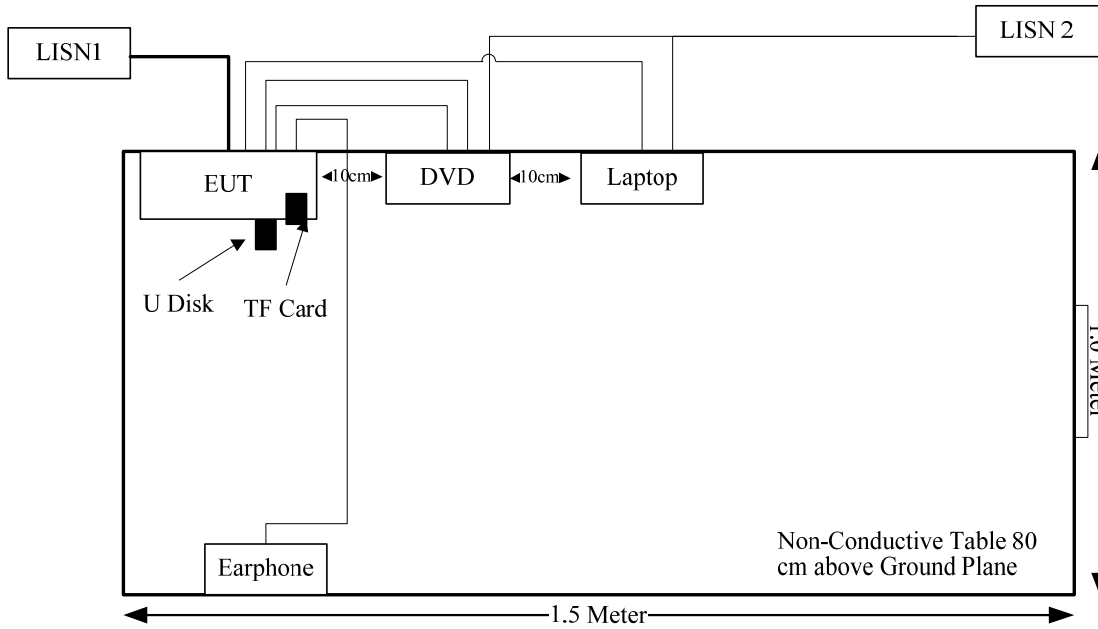

Unwanted Emissions Below 1GHz:

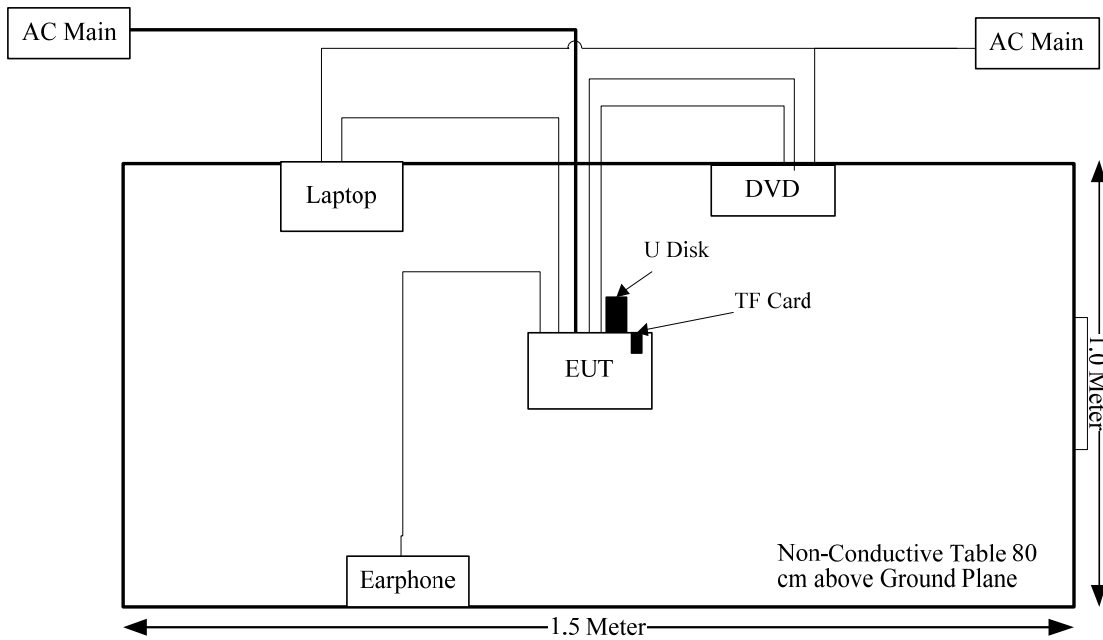

Unwanted Emissions Above 1GHz:

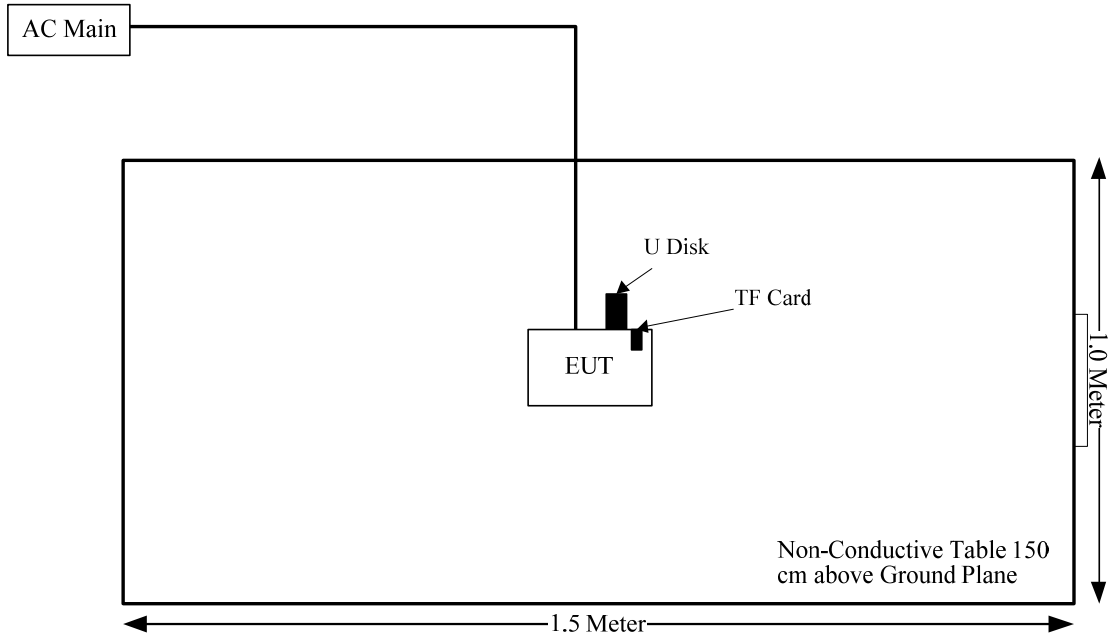

1.3 Measurement Uncertainty

Otherwise required by the applicant or Product Regulations, Decision Rule in this report did not consider the uncertainty. The extended uncertainty given in this report is obtained by combining the standard uncertainty times the coverage factor K with the 95% confidence interval.

Parameter	Measurement Uncertainty
Occupied Channel Bandwidth	±5 %
RF output power, conducted	±0.61 dB
Power Spectral Density, conducted	±0.61 dB
Unwanted Emissions, radiated	30M~200MHz: 4.15 dB, 200M~1GHz: 5.61 dB, 1G~6GHz: 5.14 dB, 6G~18GHz: 5.93 dB, 18G~26.5G: 5.47 dB, 26.5G~40G: 5.63 dB
Unwanted Emissions, conducted	±1.26 dB
Temperature	±1 °C
Humidity	±5%
DC and low frequency voltages	±0.4%
Duty Cycle	1%
AC Power Lines Conducted Emission	2.8 dB (150 kHz to 30 MHz)

2. SUMMARY OF TEST RESULTS

Standard(s) Section	Test Items	Result
§15.207(a) RSS-Gen Clause 8.8	AC line conducted emissions	Compliance
§15.205, §15.209, §15.247(d) RSS-Gen Clause 8.10	Spurious Emissions	Compliance
§15.247 (a)(2) RSS-247 Clause 5.2 a)	6 dB Bandwidth	Compliance
RSS-Gen Clause 6.7	99% Occupied Bandwidth	Compliance
§15.247(b)(3) RSS-247 Clause 5.4 d)	Maximum Conducted Output Power	Compliance
§15.247(d) RSS-247 Clause 5.5	100 kHz Bandwidth of Frequency Band Edge	Compliance
§15.247(e) RSS-247 Clause 5.2 b)	Power Spectral Density	Compliance
§15.203 RSS-GEN Clause 6.8	Antenna Requirement	Compliance
§15.247 (i) & §1.1310 & §2.1091	Maximum Permissible Exposure (MPE)	Compliance
RSS-102 Clause 2.5.2	Exemption Limits For Routine Evaluation-RF Exposure Evaluation	Compliance

3. REQUIREMENTS AND TEST PROCEDURES

3.1 AC Line Conducted Emissions

3.1.1 Applicable Standard

FCC§15.207(a).

(a) Except as shown in paragraphs (b) and (c) of this section, for an intentional radiator that is designed to be connected to the public utility (AC) power line, the radio frequency voltage that is conducted back onto the AC power line on any frequency or frequencies, within the band 150 kHz to 30 MHz, shall not exceed the limits in the following table, as measured using a 50 μ H/50 ohms line impedance stabilization network (LISN). Compliance with the provisions of this paragraph shall be based on the measurement of the radio frequency voltage between each power line and ground at the power terminal. The lower limit applies at the boundary between the frequency ranges.

Frequency of emission (MHz)	Conducted limit (dB μ V)	
	Quasi-peak	Average
0.15-0.5	66 to 56*	56 to 46*
0.5-5	56	46
5-30	60	50

*Decreases with the logarithm of the frequency.

(b) The limit shown in paragraph (a) of this section shall not apply to carrier current systems operating as intentional radiators on frequencies below 30 MHz. In lieu thereof, these carrier current systems shall be subject to the following standards:

(1) For carrier current system containing their fundamental emission within the frequency band 535-1705 kHz and intended to be received using a standard AM broadcast receiver: no limit on conducted emissions.

(2) For all other carrier current systems: 1000 μ V within the frequency band 535-1705 kHz, as measured using a 50 μ H/50 ohms LISN.

(3) Carrier current systems operating below 30 MHz are also subject to the radiated emission limits in §15.205, §15.209, §15.221, §15.223, or §15.227, as appropriate.

(c) Measurements to demonstrate compliance with the conducted limits are not required for devices which only employ battery power for operation and which do not operate from the AC power lines or contain provisions for operation while connected to the AC power lines. Devices that include, or make provisions for, the use of battery chargers which permit operating while charging, AC adapters or battery eliminators or that connect to the AC power lines indirectly, obtaining their power through another device which is connected to the AC power lines, shall be tested to demonstrate compliance with the conducted limits.

RSS-Gen Clause 8.8

Unless stated otherwise in the applicable RSS, for radio apparatus that are designed to be connected to the public utility AC power network, the radio frequency voltage that is conducted back onto the AC power line on any frequency or frequencies within the range 150 kHz to 30 MHz shall not exceed the limits in table 4, as measured using a 50 μ H / 50 Ω line impedance stabilization network. This requirement applies for the radio frequency voltage measured between each power line and the ground terminal of each AC power-line mains cable of the EUT.

For an EUT that connects to the AC power lines indirectly, through another device, the requirement for compliance with the limits in table 4 shall apply at the terminals of the AC power-line mains cable of a representative support device, while it provides power to the EUT. The lower limit applies at the boundary between the frequency ranges. The device used to power the EUT shall be representative of typical applications.

Table 4 – AC power-line conducted emissions limits

Frequency (MHz)	Conducted limit (dB μ V)	
	Quasi-peak	Average
0.15 - 0.5	66 to 56 ¹	56 to 46 ¹
0.5 – 5	56	46
5 – 30	60	50

Note 1: The level decreases linearly with the logarithm of the frequency.

For an EUT with a permanent or detachable antenna operating between 150 kHz and 30 MHz, the AC power-line conducted emissions must be measured using the following configurations:

(a) Perform the AC power-line conducted emissions test with the antenna connected to determine compliance with the limits of table 4 outside the transmitter's fundamental emission band.

(b) Retest with a dummy load instead of the antenna to determine compliance with the limits of table 4 within the transmitter's fundamental emission band. For a detachable antenna, remove the antenna and connect a suitable dummy load to the antenna connector. For a permanent antenna, remove the antenna and terminate the RF output with a dummy load or network that simulates the antenna in the fundamental frequency band.

3.1.2 EUT Setup

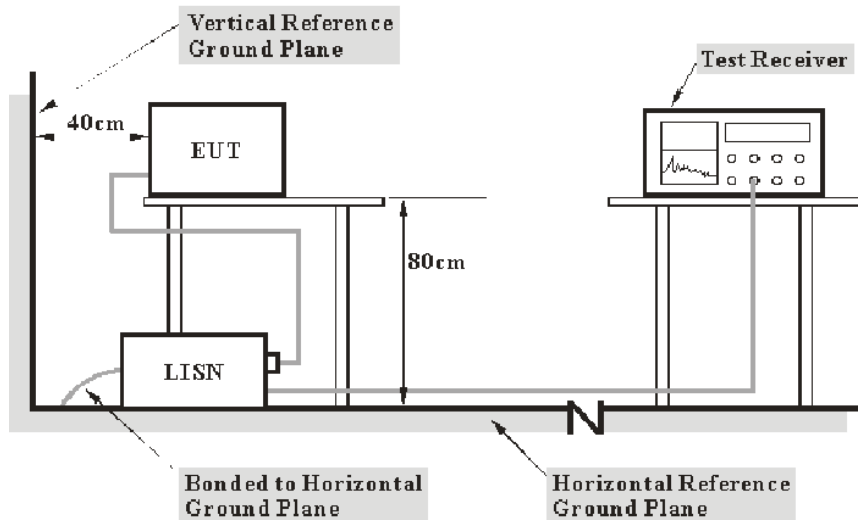

- Note: 1. Support units were connected to second LISN.
 2. Both of LISNs (AMN) 80 cm from EUT and at the least 80 cm from other units and other metal planes support units.

The setup of EUT is according with per ANSI C63.10-2013 measurement procedure. The specification used was with the FCC Part 15.207,RSS-Gen limits.

The spacing between the peripherals was 10 cm.

The adapter or EUT was connected to the main LISN with a 120 V/60 Hz AC power source.

3.1.3 EMI Test Receiver Setup

The EMI test receiver was set to investigate the spectrum from 150 kHz to 30 MHz.

During the conducted emission test, the EMI test receiver was set with the following configurations:

Frequency Range	IF B/W
150 kHz – 30 MHz	9 kHz

3.1.4 Test Procedure

The frequency and amplitude of the six highest ac power-line conducted emissions relative to the limit, measured over all the current-carrying conductors of the EUT power cords, and the operating frequency or frequency to which the EUT is tuned (if appropriate), should be reported, unless such emissions are more than 20 dB below the limit. AC power-line conducted emissions measurements are to be separately carried out only on each of the phase (“hot”) line(s) and (if used) on the neutral line(s), but not on the ground [protective earth] line(s). If less than six emission frequencies are within 20 dB of the limit, then the noise level of the measuring instrument at representative frequencies should be reported. The specific conductor of the power-line cord for each of the reported emissions should be identified. Measure the six highest emissions with respect to the limit on each current-carrying conductor of each power cord associated with the EUT (but not the power cords of associated or peripheral equipment that are part of the test configuration). Then, report the six highest emissions with respect to the limit from among all the measurements identifying the frequency and specific current-carrying conductor identified with the emission. The six highest emissions should be reported for each of the current-carrying conductors, or the six highest emissions may be reported over all the current-carrying conductors.

3.1.5 Corrected Amplitude & Margin Calculation

The basic equation is as follows:

Result = Reading + Factor

Factor = attenuation caused by cable loss + voltage division factor of AMN

The “**Margin**” column of the following data tables indicates the degree of compliance within the applicable limit. The equation for margin calculation is as follows:

Margin = Limit – Result

3.2 Radiation Spurious Emissions

3.2.1 Applicable Standard

FCC §15.247 (d);

In any 100 kHz bandwidth outside the frequency band in which the spread spectrum or digitally modulated intentional radiator is operating, the radio frequency power that is produced by the intentional radiator shall be at least 20 dB below that in the 100 kHz bandwidth within the band that contains the highest level of the desired power, based on either an RF conducted or a radiated measurement, provided the transmitter demonstrates compliance with the peak conducted power limits. If the transmitter complies with the conducted power limits based on the use of RMS averaging over a time interval, as permitted under paragraph (b)(3) of this section, the attenuation required under this paragraph shall be 30 dB instead of 20 dB. Attenuation below the general limits specified in §15.209(a) is not required. In addition, radiated emissions which fall in the restricted bands, as defined in §15.205(a), must also comply with the radiated emission limits specified in §15.209(a) (see §15.205(c)).

RSS-247 Clause 5.5

In any 100 kHz bandwidth outside the frequency band in which the spread spectrum or digitally modulated device is operating, the RF power that is produced shall be at least 20 dB below that in the 100 kHz bandwidth within the band that contains the highest level of the desired power, based on either an RF conducted or a radiated measurement, provided that the transmitter demonstrates compliance with the peak conducted power limits. If the transmitter complies with the conducted power limits based on the use of root-mean-square averaging over a time interval, as permitted under section 5.4(d), the attenuation required shall be 30 dB instead of 20 dB. Attenuation below the general field strength limits specified in RSS-Gen is not required

3.2.2 EUT Setup

Below 1GHz:

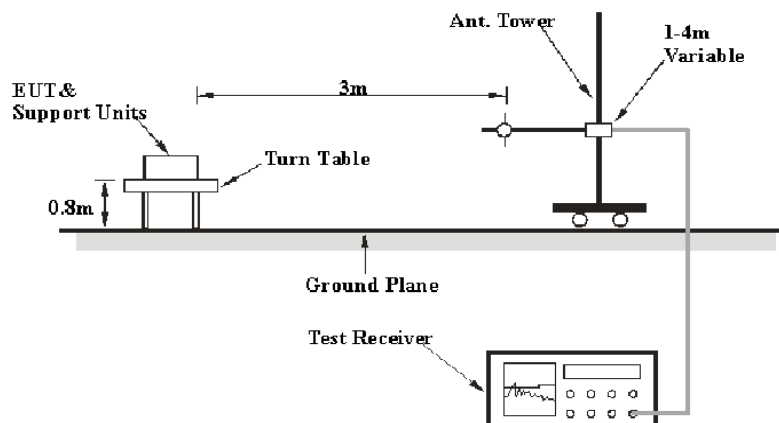

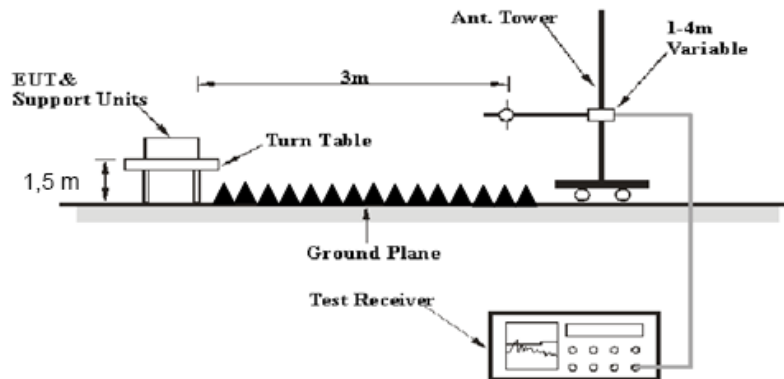
Above 1GHz:

The radiated emissions were performed in the 3 meters distance, using the setup accordance with the ANSI C63.10-2013. The specification used was the FCC 15.209, and FCC 15.247, RSS-247, RSS-Gen limits.

The external I/O cables were draped along the test table and formed a bundle 30 to 40 cm long in the middle.

The spacing between the peripherals was 10 cm.

3.2.3 EMI Test Receiver & Spectrum Analyzer Setup

The system was investigated from 30 MHz to 25 GHz.

During the radiated emission test, the EMI test receiver & Spectrum Analyzer Setup were set with the following configurations:

30MHz-1000MHz:

Measurement	RBW	Video B/W	IF B/W
QP	120 kHz	300 kHz	120kHz

1GHz- 25GHz:

Measurement	Duty cycle	RBW	Video B/W
PK	Any	1MHz	3 MHz
AV	>98%	1MHz	10 Hz
	<98%	1MHz	1/T

Note: T is minimum transmission duration

If the maximized peak measured value complies with under the QP/Average limit more than 6dB, then it is unnecessary to perform an QP/Average measurement.

3.2.4 Test Procedure

Maximizing procedure was performed on the highest emissions to ensure that the EUT complied with all installation combinations.

Data was recorded in Quasi-peak detection mode for frequency range of 30 MHz-1 GHz, peak and Average detection modes for frequencies above 1 GHz.

3.2.5 Corrected Amplitude & Margin Calculation

The basic equation is as follows:

Result = Reading + Factor

Factor = Antenna Factor + Cable Loss- Amplifier Gain

The “**Margin**” column of the following data tables indicates the degree of compliance within the applicable limit. The equation for margin calculation is as follows:

Margin = Limit – Result

3.3 6 dB Emission Bandwidth:

3.3.1 Applicable Standard

FCC §15.247 (a)(2)

Systems using digital modulation techniques may operate in the 902-928 MHz, 2400-2483.5 MHz, and 5725-5850 MHz bands. The minimum 6 dB bandwidth shall be at least 500 kHz.

RSS-247 Clause 5.2 a

The minimum 6 dB bandwidth shall be 500 kHz.

3.3.2 EUT Setup

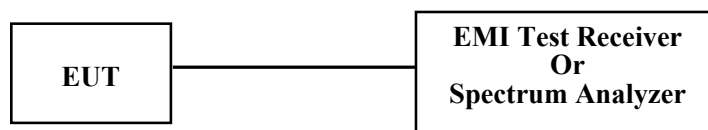

3.3.3 Test Procedure

According to ANSI C63.10-2013 Section 11.8

- a) Set RBW = 100 kHz.
- b) Set the video bandwidth (VBW) $\geq 3 \times$ RBW.
- c) Detector = Peak.
- d) Trace mode = max hold.
- e) Sweep = auto couple.
- f) Allow the trace to stabilize.
- g) Measure the maximum width of the emission that is constrained by the frequencies associated with the two outermost amplitude points (upper and lower frequencies) that are attenuated by 6 dB relative to the maximum level measured in the fundamental emission.

3.4 99% Occupied Bandwidth:

3.4.1 Applicable Standard

RSS-Gen Clause 5.2 a

The occupied bandwidth or the “99% emission bandwidth” is defined as the frequency range between two points, one above and the other below the carrier frequency, within which 99% of the total transmitted power of the fundamental transmitted emission is contained. The occupied bandwidth shall be reported for all equipment in addition to the specified bandwidth required in the applicable RSSs.

In some cases, the “x dB bandwidth” is required, which is defined as the frequency range between two points, one at the lowest frequency below and one at the highest frequency above the carrier frequency, at which the maximum power level of the transmitted emission is attenuated x dB below the maximum in-band power level of the modulated signal, where the two points are on the outskirts of the in-band emission.

3.4.2 EUT Setup



3.4.3 Test Procedure

RSS-Gen Clause 5.2 a

The following conditions shall be observed for measuring the occupied bandwidth and x dB bandwidth:

- The transmitter shall be operated at its maximum carrier power measured under normal test conditions.
- The span of the spectrum analyzer shall be set large enough to capture all products of the modulation process, including the emission skirts, around the carrier frequency, but small enough to avoid having other emissions (e.g. on adjacent channels) within the span.
- The detector of the spectrum analyzer shall be set to “Sample”. However, a peak, or peak hold, may be used in place of the sampling detector since this usually produces a wider bandwidth than the actual bandwidth (worst-case measurement). Use of a peak hold (or “Max Hold”) may be necessary to determine the occupied / x dB bandwidth if the device is not transmitting continuously.
- The resolution bandwidth (RBW) shall be in the range of 1% to 5% of the actual occupied / x dB bandwidth and the video bandwidth (VBW) shall not be smaller than three times the RBW value. Video averaging is not permitted.

Note: It may be necessary to repeat the measurement a few times until the RBW and VBW are in compliance with the above requirement.

For the 99% emission bandwidth, the trace data points are recovered and directly summed in linear power level terms. The recovered amplitude data points, beginning at the lowest frequency, are placed in a running sum until 0.5% of the total is reached, and that frequency recorded. The process is repeated for the highest frequency data points (starting at the highest frequency, at the right side of the span, and going down in frequency). This frequency is then recorded. The difference between the two recorded frequencies is the occupied bandwidth (or the 99% emission bandwidth).

3.5 Maximum conducted output power:

3.5.1 Applicable Standard

FCC §15.247 (b)(3)

For systems using digital modulation in the 902-928 MHz, 2400-2483.5 MHz, and 5725-5850 MHz bands: 1 Watt. As an alternative to a peak power measurement, compliance with the one Watt limit can be based on a measurement of the maximum conducted output power. Maximum Conducted Output Power is defined as the total transmit power delivered to all antennas and antenna elements averaged across all symbols in the signaling alphabet when the transmitter is operating at its maximum power control level. Power must be summed across all antennas and antenna elements. The average must not include any time intervals during which the transmitter is off or is transmitting at a reduced power level. If multiple modes of operation are possible (e.g., alternative modulation methods), the maximum conducted output power is the highest total transmit power occurring in any mode.

RSS-247 Clause 5.4 d

For DTSs employing digital modulation techniques operating in the bands 902-928 MHz and 2400-2483.5 MHz, the maximum peak conducted output power shall not exceed 1W. The e.i.r.p. shall not exceed 4 W, except as provided in section 5.4(e).

3.5.2 EUT Setup

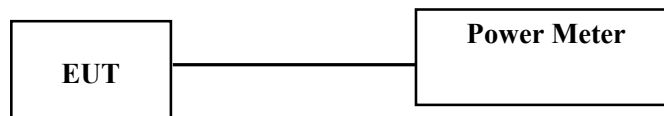

3.5.3 Test Procedure

According to ANSI C63.10-2013 Section 11.9.1.3

The maximum peak conducted output power may be measured using a broadband peak RF power meter. The power meter shall have a video bandwidth that is greater than or equal to the DTS bandwidth and shall use a fast-responding diode detector.

- a) Set the EUT in transmitting mode.
- b) Remove the antenna from the EUT and then connect a low loss RF cable from the antenna port to test equipment.
- c) Add a correction factor to the display.
- d) Set the power meter to test peak output power, record the result.

3.6 Maximum power spectral density:

3.6.1 Applicable Standard

FCC §15.247 (e)

For digitally modulated systems, the power spectral density conducted from the intentional radiator to the antenna shall not be greater than 8 dBm in any 3 kHz band during any time interval of continuous transmission. This power spectral density shall be determined in accordance with the provisions of paragraph (b) of this section. The same method of determining the conducted output power shall be used to determine the power spectral density.

RSS-247 Clause 5.2 b

The transmitter power spectral density conducted from the transmitter to the antenna shall not be greater than 8 dBm in any 3 kHz band during any time interval of continuous transmission. This power spectral density shall be determined in accordance with the provisions of section 5.4(d), (i.e. the power spectral density shall be determined using the same method as is used to determine the conducted output power).

3.6.2 EUT Setup

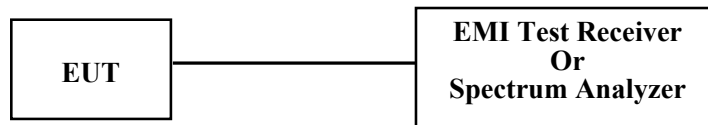

3.6.3 Test Procedure

According to ANSI C63.10-2013 Section 11.10.2

- a) Set analyzer center frequency to DTS channel center frequency.
- b) Set the span to 1.5 times the DTS bandwidth.
- c) Set the RBW to $3 \text{ kHz} \leq \text{RBW} \leq 100 \text{ kHz}$.
- d) Set the VBW $\geq [3 \cdot \text{RBW}]$.
- e) Detector = peak.
- f) Sweep time = auto couple.
- g) Trace mode = max hold.
- h) Allow trace to fully stabilize.
- i) Use the peak marker function to determine the maximum amplitude level within the RBW.
- j) If measured value exceeds requirement, then reduce RBW (but no less than 3 kHz) and repeat.

3.7 100 kHz Bandwidth of Frequency Band Edge:

3.7.1 Applicable Standard

FCC §15.247 (d);

In any 100 kHz bandwidth outside the frequency band in which the spread spectrum or digitally modulated intentional radiator is operating, the radio frequency power that is produced by the intentional radiator shall be at least 20 dB below that in the 100 kHz bandwidth within the band that contains the highest level of the desired power, based on either an RF conducted or a radiated measurement, provided the transmitter demonstrates compliance with the peak conducted power limits. If the transmitter complies with the conducted power limits based on the use of RMS averaging over a time interval, as permitted under paragraph (b)(3) of this section, the attenuation required under this paragraph shall be 30 dB instead of 20 dB. Attenuation below the general limits specified in §15.209(a) is not required. In addition, radiated emissions which fall in the restricted bands, as defined in §15.205(a), must also comply with the radiated emission limits specified in §15.209(a) (see §15.205(c)).

RSS-247 Clause 5.5

In any 100 kHz bandwidth outside the frequency band in which the spread spectrum or digitally modulated device is operating, the RF power that is produced shall be at least 20 dB below that in the 100 kHz bandwidth within the band that contains the highest level of the desired power, based on either an RF conducted or a radiated measurement, provided that the transmitter demonstrates compliance with the peak conducted power limits. If the transmitter complies with the conducted power limits based on the use of root-mean-square averaging over a time interval, as permitted under section 5.4(d), the attenuation required shall be 30 dB instead of 20 dB. Attenuation below the general field strength limits specified in RSS-Gen is not required

3.7.2 EUT Setup



3.7.3 Test Procedure

According to ANSI C63.10-2013 Section 11.11

- a) Set the center frequency and span to encompass frequency range to be measured.
- b) Set the RBW = 100 kHz.
- c) Set the VBW $\geq [3 \times \text{RBW}]$.
- d) Detector = peak.
- e) Sweep time = auto couple.
- f) Trace mode = max hold.
- g) Allow trace to fully stabilize.
- h) Use the peak marker function to determine the maximum amplitude level.

Ensure that the amplitude of all unwanted emissions outside of the authorized frequency band (excluding restricted frequency bands) is attenuated by at least the minimum requirements specified in 11.11. Report the three highest emissions relative to the limit.

3.8 Duty Cycle:

3.8.1 EUT Setup

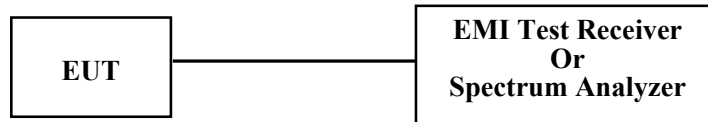

3.8.2 Test Procedure

According to ANSI C63.10-2013 Section 11.6

The zero-span mode on a spectrum analyzer or EMI receiver if the response time and spacing between bins on the sweep are sufficient to permit accurate measurements of the ON and OFF times of the transmitted signal:

- 1) Set the center frequency of the instrument to the center frequency of the transmission.
- 2) Set $RBW \geq OBW$ if possible; otherwise, set RBW to the largest available value.
- 3) Set $VBW \geq RBW$. Set detector = peak or average.
- 4) The zero-span measurement method shall not be used unless both RBW and VBW are $> 50/T$ and the number of sweep points across duration T exceeds 100. (For example, if VBW and/or RBW are limited to 3 MHz, then the zero-span method of measuring the duty cycle shall not be used if $T \leq 16.7 \mu s$.)

3.9 Antenna Requirement

3.9.1 Applicable Standard

FCC §15.203

An intentional radiator shall be designed to ensure that no antenna other than that furnished by the responsible party shall be used with the device. The use of a permanently attached antenna or of an antenna that uses a unique coupling to the intentional radiator shall be considered sufficient to comply with the provisions of this section. The manufacturer may design the unit so that a broken antenna can be replaced by the user, but the use of a standard antenna jack or electrical connector is prohibited. This requirement does not apply to carrier current devices or to devices operated under the provisions of §§15.211, 15.213, 15.217, 15.219, 15.221, or §15.236. Further, this requirement does not apply to intentional radiators that must be professionally installed, such as perimeter protection systems and some field disturbance sensors, or to other intentional radiators which, in accordance with §15.31(d), must be measured at the installation site. However, the installer shall be responsible for ensuring that the proper antenna is employed so that the limits in this part are not exceeded.

RSS-GEN Clause 6.8

The applicant for equipment certification shall provide a list of all antenna types that may be used with the transmitter, where applicable (i.e. for transmitters with detachable antenna), indicating the maximum permissible antenna gain (in dBi) and the required impedance for each antenna. The test report shall demonstrate the compliance of the transmitter with the limit for maximum equivalent isotropically radiated power (e.i.r.p.) specified in the applicable RSS, when the transmitter is equipped with any antenna type, selected from this list.

For expediting the testing, measurements may be performed using only the antenna with highest gain of each combination of transmitter and antenna type, with the transmitter output power set at the maximum level. However, the transmitter shall comply with the applicable requirements under all operational conditions and when in combination with any type of antenna from the list provided in the test report (and in the notice to be included in the user manual, provided below).

When measurements at the antenna port are used to determine the RF output power, the effective gain of the device's antenna shall be stated, based on a measurement or on data from the antenna's manufacturer.

The test report shall state the RF power, output power setting and spurious emission measurements with each antenna type that is used with the transmitter being tested.

For licence-exempt equipment with detachable antennas, the user manual shall also contain the following notice in a conspicuous location:

This radio transmitter [enter the device's ISED certification number] has been approved by Innovation, Science and Economic Development Canada to operate with the antenna types listed below, with the maximum permissible gain indicated. Antenna types not included in this list that have a gain greater than the maximum gain indicated for any type listed are strictly prohibited for use with this device.

Immediately following the above notice, the manufacturer shall provide a list of all antenna types which can be used with the transmitter, indicating the maximum permissible antenna gain (in dBi) and the required impedance for each antenna type.

3.9.2 Judgment

Please refer to the Antenna Information detail in Section 1.

4. Test DATA AND RESULTS

4.1 AC Line Conducted Emissions

Serial Number:	CR21110068-RF-S1	Test Date:	2021-11-26
Test Site:	CE	Test Mode:	Transmitting (802.11b Middle channel was the worst)
Tester:	Nick Tang	Test Result:	Pass

Environmental Conditions:

Temperature: (°C)	20.7	Relative Humidity: (%)	52	ATM Pressure: (kPa)	101.3
----------------------	------	---------------------------	----	------------------------	-------

Test Equipment List and Details:

Manufacturer	Description	Model	Serial Number	Calibration Date	Calibration Due Date
R&S	LISN	ENV216	101132	2021-04-25	2022-04-24
R&S	LISN	ENV216	101134	2021-04-25	2022-04-24
R&S	EMI Test Receiver	ESR3	102726	2021-07-22	2022-07-21
MICRO-COAX	Coaxial Cable	UTIFLEX	C-0200-01	2021-08-08	2022-08-07
Audix	Test Software	E3	190306 (V9)	N/A	N/A

* Statement of Traceability: China Certification ICT Co., Ltd (Dongguan) attests that all calibrations have been performed, traceable to National Primary Standards and International System of Units (SI).

Line:

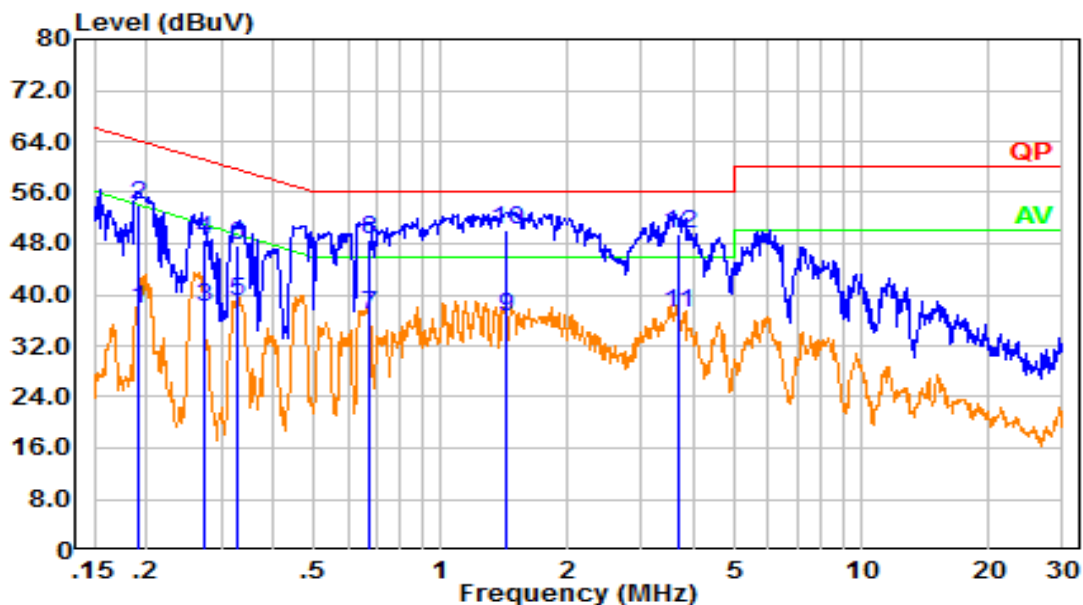

No.	Frequency (MHz)	Reading (dBμV)	Factor (dB)	Result (dBμV)	Limit (dBμV)	Margin (dB)	Detector
1	0.190	28.06	9.61	37.67	54.02	16.35	Average
2	0.190	44.46	9.61	54.07	64.02	9.95	QP
3	0.274	28.50	9.61	38.11	51.01	12.90	Average
4	0.274	39.09	9.61	48.70	61.01	12.31	QP
5	0.327	29.32	9.61	38.93	49.54	10.61	Average
6	0.327	38.19	9.61	47.80	59.54	11.74	QP
7	0.672	27.18	9.62	36.80	46.00	9.20	Average
8	0.672	39.08	9.62	48.70	56.00	7.30	QP
9	1.432	26.88	9.62	36.50	46.00	9.50	Average
10	1.432	40.49	9.62	50.12	56.00	5.88	QP
11	3.666	27.51	9.65	37.16	46.00	8.84	Average
12	3.666	39.88	9.65	49.53	56.00	6.47	QP

Neutral:

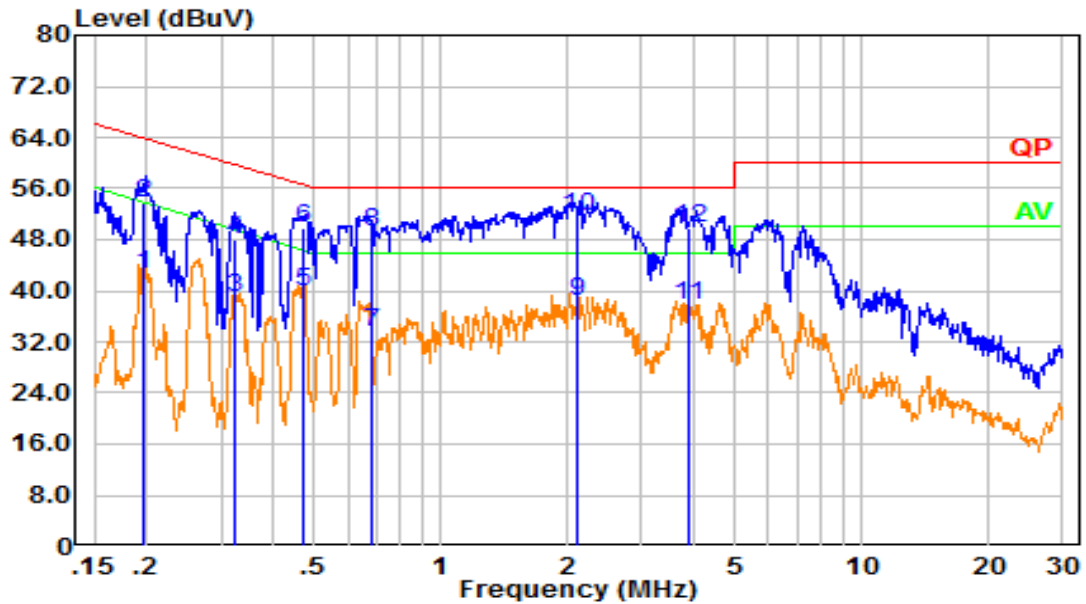

No.	Frequency (MHz)	Reading (dB μ V)	Factor (dB)	Result (dB μ V)	Limit (dB μ V)	Margin (dB)	Detector
1	0.197	32.82	9.61	42.43	53.73	11.30	Average
2	0.197	44.19	9.61	53.80	63.73	9.93	QP
3	0.322	29.30	9.61	38.91	49.65	10.74	Average
4	0.322	38.27	9.61	47.88	59.65	11.77	QP
5	0.470	30.32	9.61	39.93	46.51	6.58	Average
6	0.470	40.23	9.61	49.84	56.51	6.67	QP
7	0.682	24.04	9.62	33.66	46.00	12.34	Average
8	0.682	39.69	9.62	49.31	56.00	6.69	QP
9	2.115	28.71	9.63	38.35	46.00	7.65	Average
10	2.115	42.06	9.63	51.70	56.00	4.30	QP
11	3.871	28.11	9.65	37.76	46.00	8.24	Average
12	3.871	40.14	9.65	49.79	56.00	6.21	QP

4.2 Radiation Spurious Emissions

Serial Number:	CR21110068-RF-S1	Test Date:	2021-11-29
Test Site:	966-1,966-2	Test Mode:	Transmitting
Tester:	Great Qiao	Test Result:	Pass

Environmental Conditions:

Temperature: (°C)	22.6	Relative Humidity: (%)	59	ATM Pressure: (kPa)	101.3
----------------------	------	------------------------------	----	------------------------	-------

Test Equipment List and Details:

Manufacturer	Description	Model	Serial Number	Calibration Date	Calibration Due Date
Sunol Sciences	Antenna	JB6	A082520-5	2020-10-19	2023-10-18
R&S	EMI Test Receiver	ESR3	102724	2021-07-22	2022-07-21
TIMES MICROWAVE	Coaxial Cable	LMR-600-UltraFlex	C-0470-02	2021-07-18	2022-07-17
TIMES MICROWAVE	Coaxial Cable	LMR-600-UltraFlex	C-0780-01	2021-07-18	2022-07-17
Sonoma	Amplifier	310N	186165	2021-07-18	2022-07-17
Audix	Test Software	E3	201021 (V9)	N/A	N/A
ETS-Lindgren	Horn Antenna	3115	9912-5985	2020-10-13	2023-10-12
PASTERNAK	Horn Antenna	PE9852/2F-20	112002	2021-02-05	2023-02-04
R&S	Spectrum Analyzer	FSV40	101591	2021-07-22	2022-07-21
MICRO-COAX	Coaxial Cable	UFA210A-1-1200-70U300	217423-008	2021-08-08	2022-08-07
MICRO-COAX	Coaxial Cable	UFA210A-1-2362-300300	235780-001	2021-08-08	2022-08-07
MICRO-COAX	Coaxial Cable	UFB142A-1-2362-200200	235772-001	2021-08-08	2022-08-07
Mini	Pre-amplifier	ZVA-183-S+	5969001149	2021-11-10	2022-11-09
AH	Preamplifier	PAM-1840VH	190	2021-11-20	2022-11-19
E-Microwave	Band Rejection Filter	2400-2483.5MHz	OE01902424	2021-08-08	2022-08-07
Mini Circuits	High Pass Filter	VHF-6010+	31119	2021-08-08	2022-08-07

* Statement of Traceability: China Certification ICT Co., Ltd (Dongguan) attests that all calibrations have been performed, traceable to National Primary Standards and International System of Units (SI).

1) 30MHz-1GHz(802.11b middle channel was the worst)

Horizontal:

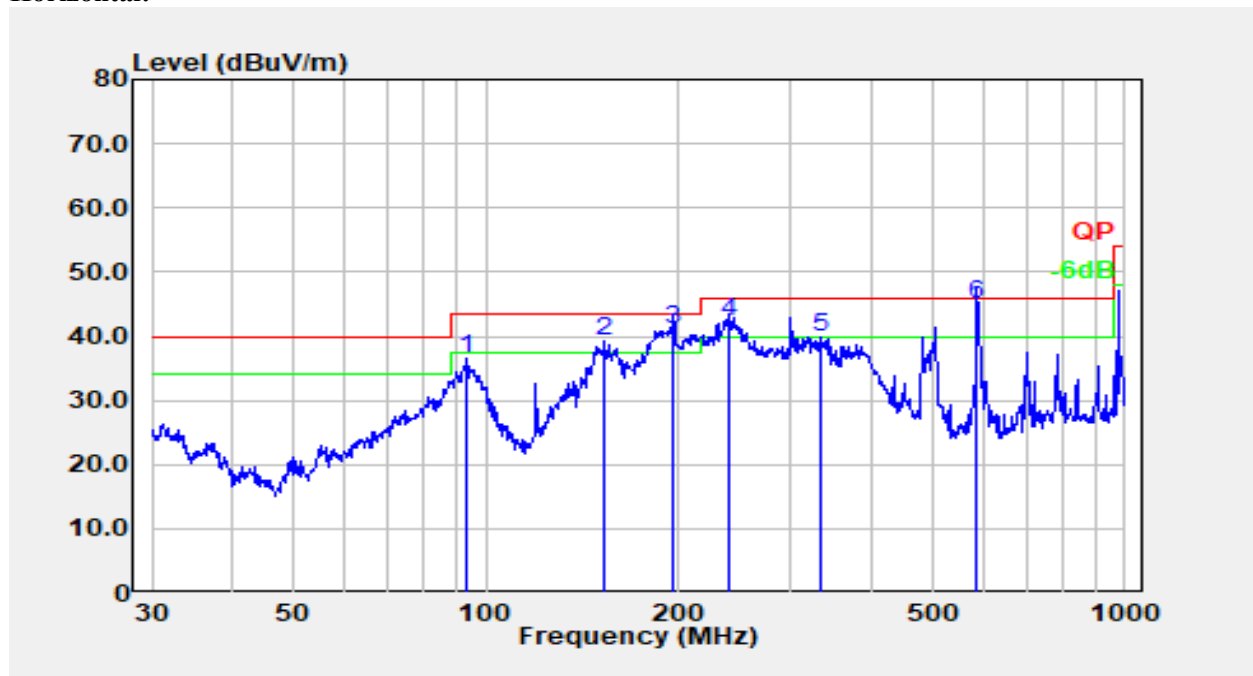

No.	Frequency (MHz)	Reading (dBuV)	Factor (dB/m)	Result (dBuV/m)	Limit (dBuV/m)	Margin (dB)	Detector
1	93.113	52.78	-16.37	36.41	43.50	7.09	Peak
2	153.200	51.67	-12.30	39.37	43.50	4.13	QP
3	196.510	53.88	-12.74	41.14	43.50	2.36	QP
4	239.147	55.57	-13.18	42.39	46.00	3.61	QP
5	333.687	50.32	-10.36	39.96	46.00	6.04	Peak
6	586.844	50.60	-5.67	44.93	46.00	1.07	QP

Vertical:

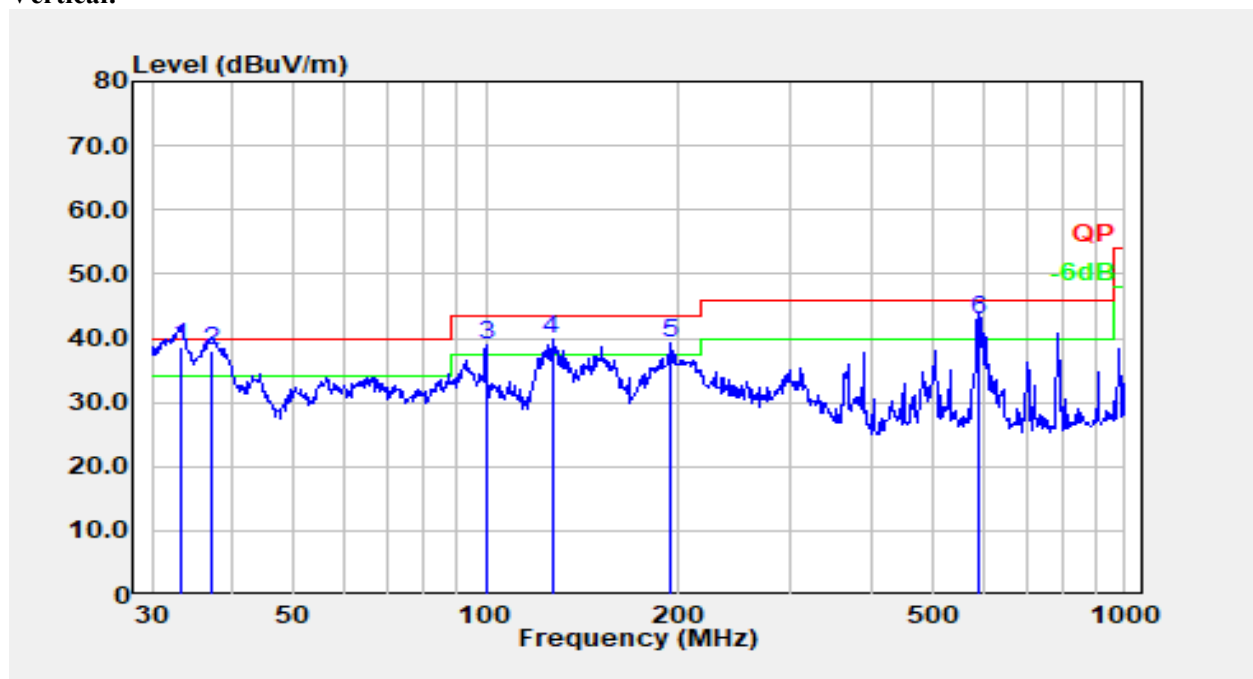

No.	Frequency (MHz)	Reading (dB μ V)	Factor (dB/m)	Result (dB μ V/m)	Limit (dB μ V/m)	Margin (dB)	Detector
1	33.211	45.00	-6.28	38.72	40.00	1.28	QP
2	37.285	47.49	-9.40	38.10	40.00	1.90	QP
3	99.878	53.50	-14.62	38.88	43.50	4.62	QP
4	126.772	51.58	-11.60	39.98	43.50	3.52	QP
5	195.137	52.08	-12.91	39.16	43.50	4.34	QP
6	593.050	48.34	-5.47	42.87	46.00	3.13	QP

**2) 1-25GHz:
802.11b Mode:**

Frequency (MHz)	Receiver		Polar (H/V)	Factor (dB/m)	Result (dB μ V/m)	Limit (dB μ V/m)	Margin (dB)
	Reading (dB μ V)	Detector					
Low Channel: 2412 MHz							
2412.00	73.71	PK	H	31.53	105.24	N/A	N/A
2412.00	69.43	AV	H	31.53	100.96	N/A	N/A
2412.00	75.91	PK	V	31.53	107.44	N/A	N/A
2412.00	71.66	AV	V	31.53	103.19	N/A	N/A
2390.00	25.83	PK	V	31.46	57.29	74.00	16.71
2390.00	14.18	AV	V	31.46	45.64	54.00	8.36
4824.00	41.24	PK	V	10.94	52.18	74.00	21.82
4824.00	35.76	AV	V	10.94	46.70	54.00	7.30
7236.00	36.79	PK	V	14.44	51.23	74.00	22.77
7236.00	23.76	AV	V	14.44	38.20	54.00	15.80
Middle Channel: 2437 MHz							
2437.00	73.18	PK	H	31.60	104.78	N/A	N/A
2437.00	69.02	AV	H	31.60	100.62	N/A	N/A
2437.00	76.37	PK	V	31.60	107.97	N/A	N/A
2437.00	72.19	AV	V	31.60	103.79	N/A	N/A
4874.00	42.99	PK	V	11.05	54.04	74.00	19.96
4874.00	37.06	AV	V	11.05	48.11	54.00	5.89
7311.00	37.12	PK	V	14.80	51.92	74.00	22.08
7311.00	24.05	AV	V	14.80	38.85	54.00	15.15
High Channel: 2462MHz							
2462.00	72.45	PK	H	31.63	104.08	N/A	N/A
2462.00	68.16	AV	H	31.63	99.79	N/A	N/A
2462.00	76.01	PK	V	31.63	107.64	N/A	N/A
2462.00	71.53	AV	V	31.63	103.16	N/A	N/A
2483.50	25.99	PK	V	31.64	57.63	74.00	16.37
2483.50	14.28	AV	V	31.64	45.92	54.00	8.08
4924.00	42.33	PK	V	11.18	53.51	74.00	20.49
4924.00	36.64	AV	V	11.18	47.82	54.00	6.18
7386.00	37.10	PK	V	14.89	51.99	74.00	22.01
7386.00	24.04	AV	V	14.89	38.93	54.00	15.07

802.11g Mode:

Frequency (MHz)	Receiver		Polar (H/V)	Factor (dB/m)	Result (dB μ V/m)	Limit (dB μ V/m)	Margin (dB)
	Reading (dB μ V)	Detector					
Low Channel: 2412 MHz							
2412.00	73.12	PK	H	31.53	104.65	N/A	N/A
2412.00	61.97	AV	H	31.53	93.50	N/A	N/A
2412.00	74.84	PK	V	31.53	106.37	N/A	N/A
2412.00	64.26	AV	V	31.53	95.79	N/A	N/A
2390.00	27.99	PK	V	31.46	59.45	74.00	14.55
2390.00	15.04	AV	V	31.46	46.50	54.00	7.50
4824.00	39.14	PK	V	10.94	50.08	74.00	23.92
4824.00	25.16	AV	V	10.94	36.10	54.00	17.90
7236.00	36.96	PK	V	14.44	51.40	74.00	22.60
7236.00	23.94	AV	V	14.44	38.38	54.00	15.62
Middle Channel: 2437 MHz							
2437.00	73.86	PK	H	31.60	105.46	N/A	N/A
2437.00	62.74	AV	H	31.60	94.34	N/A	N/A
2437.00	75.54	PK	V	31.60	107.14	N/A	N/A
2437.00	64.43	AV	V	31.60	96.03	N/A	N/A
4874.00	39.63	PK	V	11.05	50.68	74.00	23.32
4874.00	25.33	AV	V	11.05	36.38	54.00	17.62
7311.00	37.02	PK	V	14.80	51.82	74.00	22.18
7311.00	24.01	AV	V	14.80	38.81	54.00	15.19
High Channel: 2462MHz							
2462.00	73.68	PK	H	31.63	105.31	N/A	N/A
2462.00	62.55	AV	H	31.63	94.18	N/A	N/A
2462.00	75.14	PK	V	31.63	106.77	N/A	N/A
2462.00	63.90	AV	V	31.63	95.53	N/A	N/A
2483.50	26.65	PK	V	31.64	58.29	74.00	15.71
2483.50	14.77	AV	V	31.64	46.41	54.00	7.59
4924.00	39.47	PK	V	11.18	50.65	74.00	23.35
4924.00	25.25	AV	V	11.18	36.43	54.00	17.57
7386.00	36.95	PK	V	14.89	51.84	74.00	22.16
7386.00	23.96	AV	V	14.89	38.85	54.00	15.15

802.11n ht20 Mode:

Frequency (MHz)	Receiver		Polar (H/V)	Factor (dB/m)	Result (dB μ V/m)	Limit (dB μ V/m)	Margin (dB)
	Reading (dB μ V)	Detector					
Low Channel: 2412 MHz							
2412.00	71.27	PK	H	31.53	102.80	N/A	N/A
2412.00	61.14	AV	H	31.53	92.67	N/A	N/A
2412.00	73.53	PK	V	31.53	105.06	N/A	N/A
2412.00	63.33	AV	V	31.53	94.86	N/A	N/A
2390.00	28.51	PK	V	31.46	59.97	74.00	14.03
2390.00	15.10	AV	V	31.46	46.56	54.00	7.44
4824.00	38.62	PK	V	10.94	49.56	74.00	24.44
4824.00	25.06	AV	V	10.94	36.00	54.00	18.00
7236.00	36.87	PK	V	14.44	51.31	74.00	22.69
7236.00	23.89	AV	V	14.44	38.33	54.00	15.67
Middle Channel: 2437 MHz							
2437.00	72.16	PK	H	31.60	103.76	N/A	N/A
2437.00	62.25	AV	H	31.60	93.85	N/A	N/A
2437.00	74.42	PK	V	31.60	106.02	N/A	N/A
2437.00	64.36	AV	V	31.60	95.96	N/A	N/A
4874.00	38.75	PK	V	11.05	49.80	74.00	24.20
4874.00	25.14	AV	V	11.05	36.19	54.00	17.81
7311.00	37.05	PK	V	14.80	51.85	74.00	22.15
7311.00	24.03	AV	V	14.80	38.83	54.00	15.17
High Channel: 2462MHz							
2462.00	71.86	PK	H	31.63	103.49	N/A	N/A
2462.00	61.68	AV	H	31.63	93.31	N/A	N/A
2462.00	74.04	PK	V	31.63	105.67	N/A	N/A
2462.00	63.85	AV	V	31.63	95.48	N/A	N/A
2483.50	27.23	PK	V	31.64	58.87	74.00	15.13
2483.50	14.74	AV	V	31.64	46.38	54.00	7.62
4924.00	38.57	PK	V	11.18	49.75	74.00	24.25
4924.00	24.98	AV	V	11.18	36.16	54.00	17.84
7386.00	36.94	PK	V	14.89	51.83	74.00	22.17
7386.00	23.92	AV	V	14.89	38.81	54.00	15.19

802.11n ht40 Mode:

Frequency (MHz)	Receiver		Polar (H/V)	Factor (dB/m)	Result (dB μ V/m)	Limit (dB μ V/m)	Margin (dB)
	Reading (dB μ V)	Detector					
Low Channel: 2422 MHz							
2422.00	68.97	PK	H	31.56	100.53	N/A	N/A
2422.00	58.66	AV	H	31.56	90.22	N/A	N/A
2422.00	71.59	PK	V	31.56	103.15	N/A	N/A
2422.00	61.14	AV	V	31.56	92.70	N/A	N/A
2390.00	33.97	PK	V	31.46	65.43	74.00	8.57
2390.00	18.56	AV	V	31.46	50.02	54.00	3.98
4844.00	37.75	PK	V	10.96	48.71	74.00	25.29
4844.00	24.47	AV	V	10.96	35.43	54.00	18.57
7266.00	36.85	PK	V	14.63	51.48	74.00	22.52
7266.00	23.75	AV	V	14.63	38.38	54.00	15.62
Middle Channel: 2437 MHz							
2437.00	68.36	PK	H	31.60	99.96	N/A	N/A
2437.00	58.13	AV	H	31.60	89.73	N/A	N/A
2437.00	71.23	PK	V	31.60	102.83	N/A	N/A
2437.00	60.87	AV	V	31.60	92.47	N/A	N/A
4874.00	37.93	PK	V	11.05	48.98	74.00	25.02
4874.00	24.63	AV	V	11.05	35.68	54.00	18.32
7311.00	36.94	PK	V	14.80	51.74	74.00	22.26
7311.00	23.82	AV	V	14.80	38.62	54.00	15.38
High Channel: 2452MHz							
2452.00	68.85	PK	H	31.63	100.48	N/A	N/A
2452.00	58.37	AV	H	31.63	90.00	N/A	N/A
2452.00	71.69	PK	V	31.63	103.32	N/A	N/A
2452.00	61.02	AV	V	31.63	92.65	N/A	N/A
2483.50	31.06	PK	V	31.64	62.70	74.00	11.30
2483.50	17.10	AV	V	31.64	48.74	54.00	5.26
4904.00	37.77	PK	V	11.14	48.91	74.00	25.09
4904.00	24.48	AV	V	11.14	35.62	54.00	18.38
7356.00	36.81	PK	V	14.80	51.61	74.00	22.39
7356.00	23.82	AV	V	14.80	38.62	54.00	15.38

Worst Test plots(802.11b middle channel was the worst)
Horizontal:

Fundamental Test with Band Rejection Filter

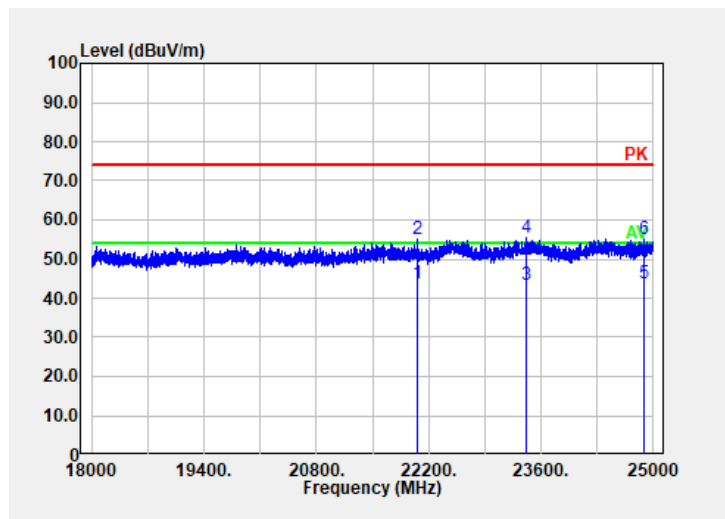
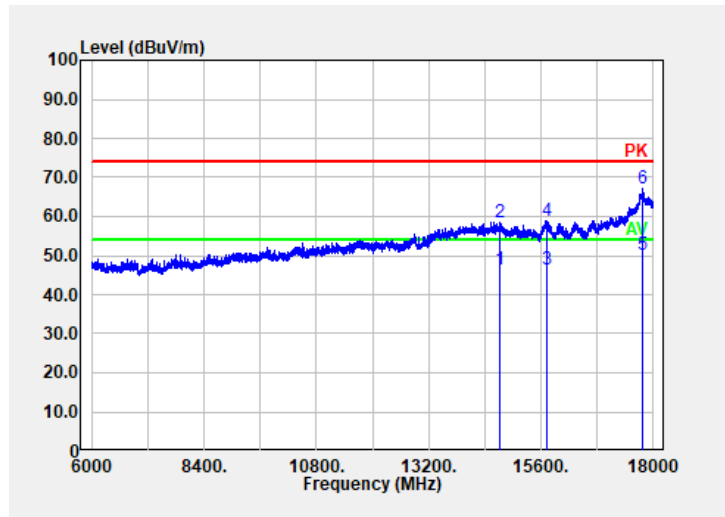
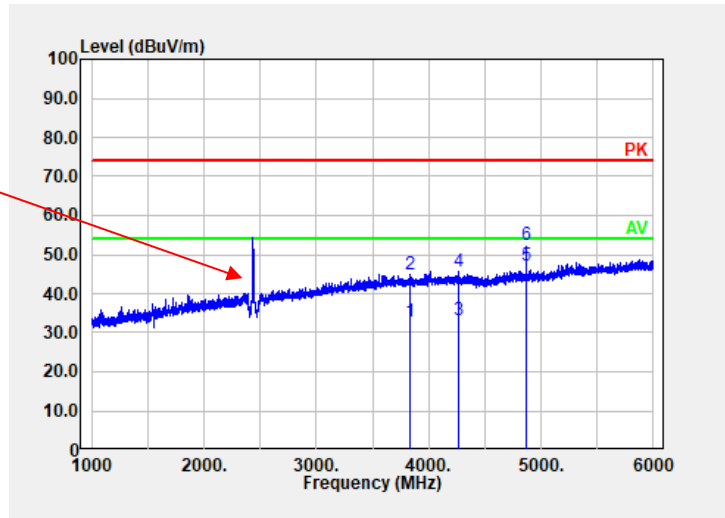

Vertical:

Fundamental Test with Band Rejection Filter

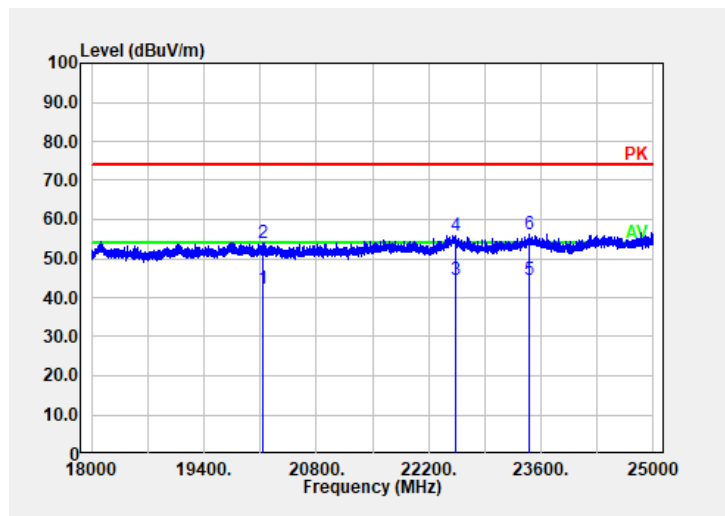
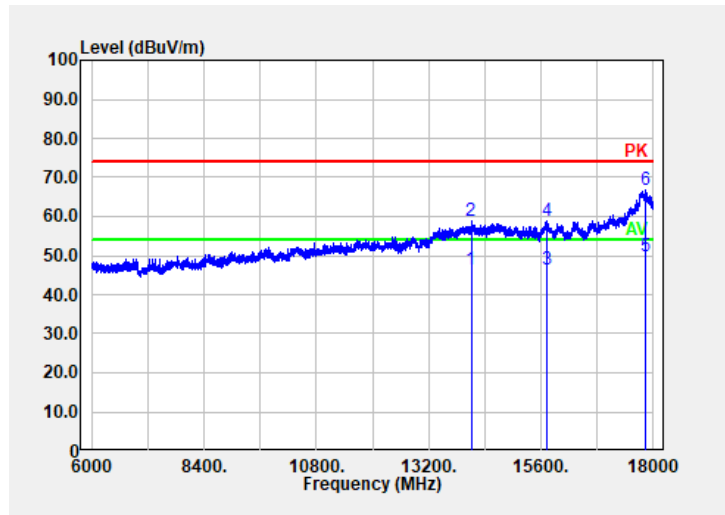
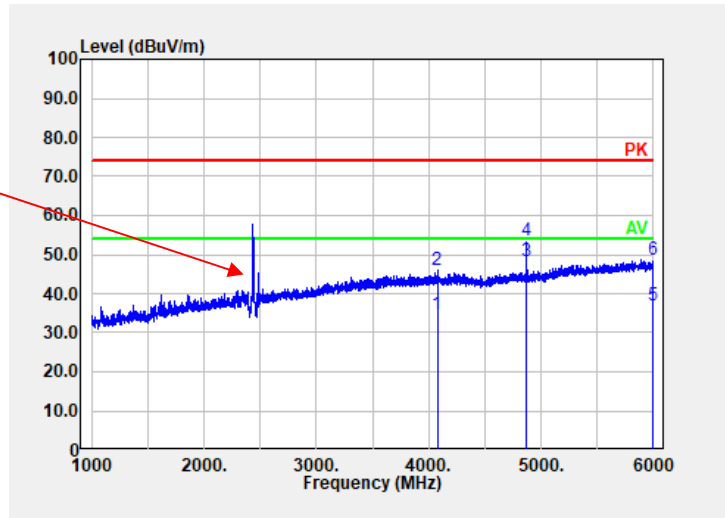

4.3 6 dB Emission Bandwidth:

Serial Number:	CR21100068-RF-S1	Test Date:	2021.11.17
Test Site:	RF	Test Mode:	Transmitting
Tester:	Will wei	Test Result:	Pass

Environmental Conditions:

Temperature: (°C)	24.9	Relative Humidity: (%)	59	ATM Pressure: (kPa)	101
----------------------	------	---------------------------	----	------------------------	-----

Test Equipment List and Details:

Manufacturer	Description	Model	Serial Number	Calibration Date	Calibration Due Date
R&S	Spectrum Analyzer	FSV40	101474	2021-07-22	2022-07-21
zhuoxiang	Coaxial Cable	SMA-178	211001	Each time	N/A
Mini-Circuits	DC Block	BLK-18-S+	1554403	Each time	N/A

* *Statement of Traceability: China Certification ICT Co., Ltd (Dongguan) attests that all calibrations have been performed, traceable to National Primary Standards and International System of Units (SI).*

Test Data:

Test Modes	Test Frequency (MHz)	6 dB Bandwidth (MHz)	Limit (MHz)
802.11b	2412	10.000	0.5
	2437	10.000	0.5
	2462	10.080	0.5
802.11g	2412	16.160	0.5
	2437	16.000	0.5
	2462	16.080	0.5
802.11n ht20	2412	17.280	0.5
	2437	17.520	0.5
	2462	17.600	0.5
802.11n ht40	2422	35.680	0.5
	2437	35.680	0.5
	2452	35.520	0.5

6dB Emission Bandwidth

802.11b
Lowest Channel

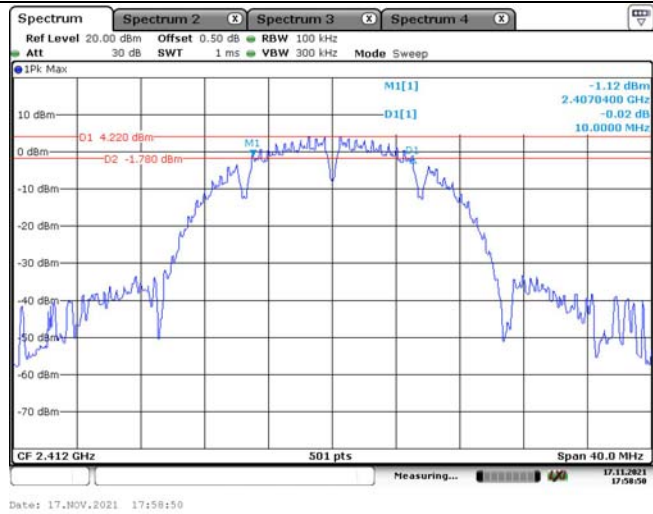

802.11b
Middle Channel

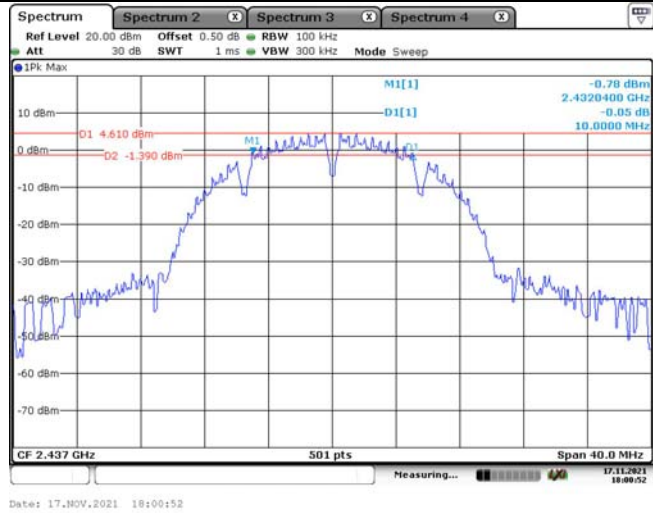

802.11b
Highest Channel

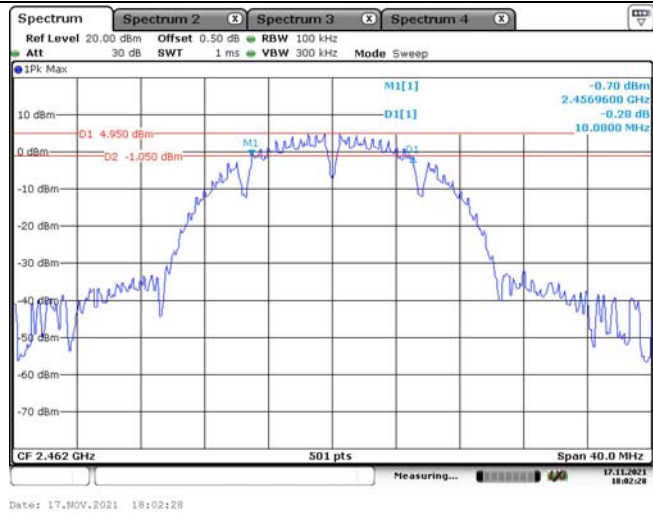

6dB Emission Bandwidth

<p>802.11g Lowest Channel</p>	<p>CF 2.412 GHz 501 pts Span 40.0 MHz</p> <p>Date: 17.NOV.2021 18:04:42</p>
<p>802.11g Middle Channel</p>	<p>CF 2.437 GHz 501 pts Span 40.0 MHz</p> <p>Date: 17.NOV.2021 18:06:11</p>
<p>802.11g Highest Channel</p>	<p>CF 2.462 GHz 501 pts Span 40.0 MHz</p> <p>Date: 17.NOV.2021 18:08:36</p>

6dB Emission Bandwidth

<p>802.11n ht20 Lowest Channel</p>	
<p>802.11n ht20 Middle Channel</p>	
<p>802.11n ht20 Highest Channel</p>	

6dB Emission Bandwidth

802.11n ht40
Lowest Channel

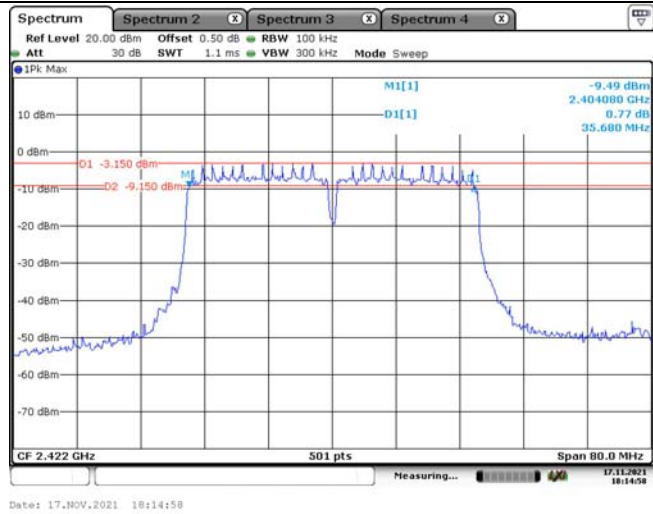

802.11n ht40
Middle Channel

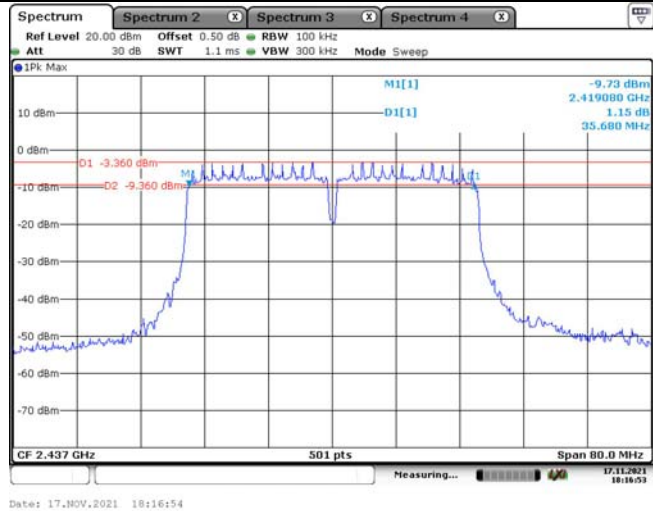

802.11n ht40
Highest Channel

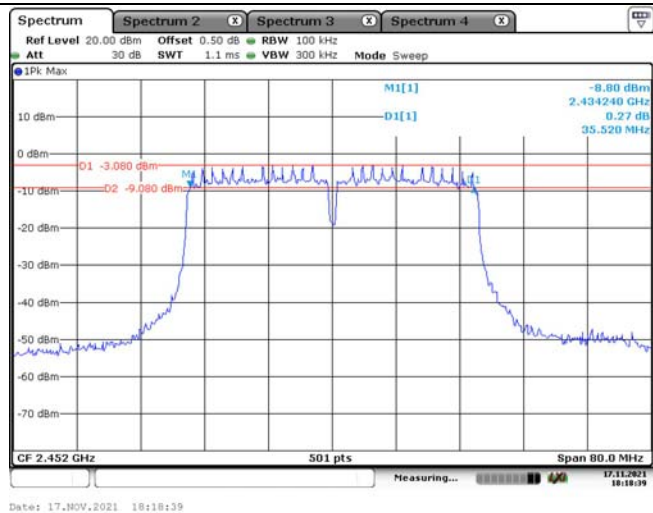

4.4 99% Occupied Bandwidth:

Serial Number:	CR21100068-RF-S1	Test Date:	2021.11.17
Test Site:	RF	Test Mode:	Transmitting
Tester:	Will wei	Test Result:	N/A

Environmental Conditions:

Temperature: (°C)	24.9	Relative Humidity: (%)	59	ATM Pressure: (kPa)	101
----------------------	------	---------------------------	----	------------------------	-----

Test Equipment List and Details:



Manufacturer	Description	Model	Serial Number	Calibration Date	Calibration Due Date
R&S	Spectrum Analyzer	FSV40	101474	2021/7/22	2022/7/21
zhuoxiang	Coaxial Cable	SMA-178	211001	Each time	N/A
Mini-Circuits	DC Block	BLK-18-S+	1554403	Each time	N/A

* Statement of Traceability: China Certification ICT Co., Ltd (Dongguan) attests that all calibrations have been performed, traceable to National Primary Standards and International System of Units (SI).

Test Data:

Test Channel	Test Channel	Test Frequency (MHz)	99% Occupied Bandwidth (MHz)
802.11b	Lowest	2412	15.729
	Middle	2437	15.808
	Highest	2462	15.649
802.11g	Lowest	2412	16.846
	Middle	2437	16.846
	Highest	2462	16.846
802.11n ht20	Lowest	2412	17.964
	Middle	2437	17.964
	Highest	2462	17.964
802.11n ht40	Lowest	2422	36.088
	Middle	2437	36.088
	Highest	2452	36.088

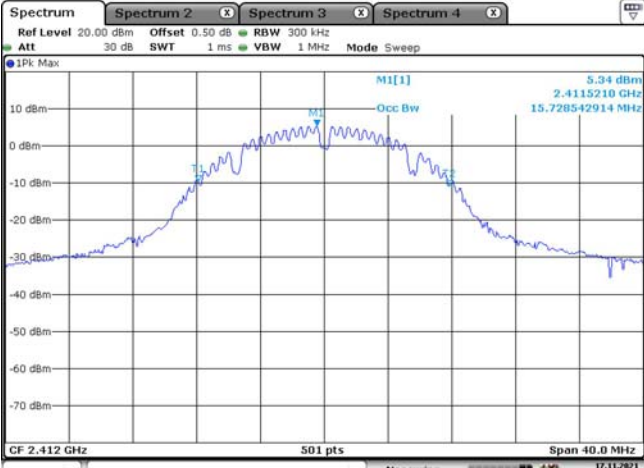
99% Occupied Bandwidth

<p>802.11b Lowest Channel</p>	 <p>Spectrum 2 Spectrum 3 Spectrum 4 Ref Level 20.00 dBm Offset 0.50 dB RBW 300 kHz Att 30 dB SWT 1 ms VBW 1 MHz Mode Sweep 1Pk Max MI[1] 5.34 dBm Occ Bw 2.4115210 GHz 15.728542914 MHz CF 2.412 GHz 501 pts Span 40.0 MHz Date: 17.NOV.2021 17:59:19</p>
<p>802.11b Middle Channel</p>	 <p>Spectrum 2 Spectrum 3 Spectrum 4 Ref Level 20.00 dBm Offset 0.50 dB RBW 300 kHz Att 30 dB SWT 1 ms VBW 1 MHz Mode Sweep 1Pk Max MI[1] 5.51 dBm Occ Bw 2.4375590 GHz 15.808393234 MHz CF 2.437 GHz 501 pts Span 40.0 MHz Date: 17.NOV.2021 18:01:22</p>
<p>802.11b Highest Channel</p>	 <p>Spectrum 2 Spectrum 3 Spectrum 4 Ref Level 20.00 dBm Offset 0.50 dB RBW 300 kHz Att 30 dB SWT 1 ms VBW 1 MHz Mode Sweep 1Pk Max MI[1] 5.64 dBm Occ Bw 2.4615210 GHz 15.648702595 MHz CF 2.462 GHz 501 pts Span 40.0 MHz Date: 17.NOV.2021 18:02:55</p>

99% Occupied Bandwidth

<p>802.11g Lowest Channel</p>	<p>Spectrum 2 Spectrum 3 Spectrum 4</p> <p>Ref Level 20.00 dBm Offset 0.50 dB RBW 300 kHz</p> <p>Att 30 dB SWT 1 ms VBW 1 MHz Mode Sweep</p> <p>1Pk Max</p> <p>MI[1] 5.17 dBm</p> <p>MI 2.4104030 GHz</p> <p>Occ Bw 16.846307385 MHz</p> <p>CF 2.412 GHz 501 pts Span 40.0 MHz</p> <p>Date: 17.NOV.2021 18:04:59</p>
<p>802.11g Middle Channel</p>	<p>Spectrum 2 Spectrum 3 Spectrum 4</p> <p>Ref Level 20.00 dBm Offset 0.50 dB RBW 300 kHz</p> <p>Att 30 dB SWT 1 ms VBW 1 MHz Mode Sweep</p> <p>1Pk Max</p> <p>MI[1] 4.79 dBm</p> <p>MI 2.4354030 GHz</p> <p>Occ Bw 16.846307385 MHz</p> <p>CF 2.437 GHz 501 pts Span 40.0 MHz</p> <p>Date: 17.NOV.2021 18:06:25</p>
<p>802.11g Highest Channel</p>	<p>Spectrum 2 Spectrum 3 Spectrum 4</p> <p>Ref Level 20.00 dBm Offset 0.50 dB RBW 300 kHz</p> <p>Att 30 dB SWT 1 ms VBW 1 MHz Mode Sweep</p> <p>1Pk Max</p> <p>MI[1] 4.96 dBm</p> <p>MI 2.4604030 GHz</p> <p>Occ Bw 16.846307385 MHz</p> <p>CF 2.462 GHz 501 pts Span 40.0 MHz</p> <p>Date: 17.NOV.2021 18:08:54</p>

99% Occupied Bandwidth

<p>802.11n ht20 Lowest Channel</p>	
<p>802.11n ht20 Middle Channel</p>	
<p>802.11n ht20 Highest Channel</p>	

99% Occupied Bandwidth

802.11n ht40
Lowest Channel

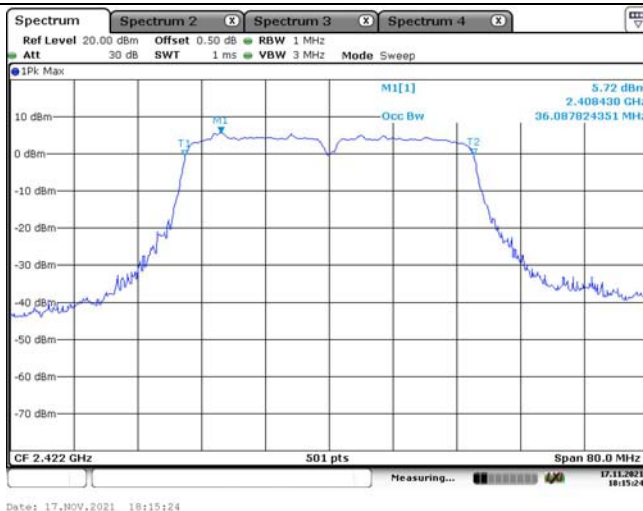

Date: 17.NOV.2021 18:15:24

802.11n ht40
Middle Channel



Date: 17.NOV.2021 18:17:14

802.11n ht40
Highest Channel

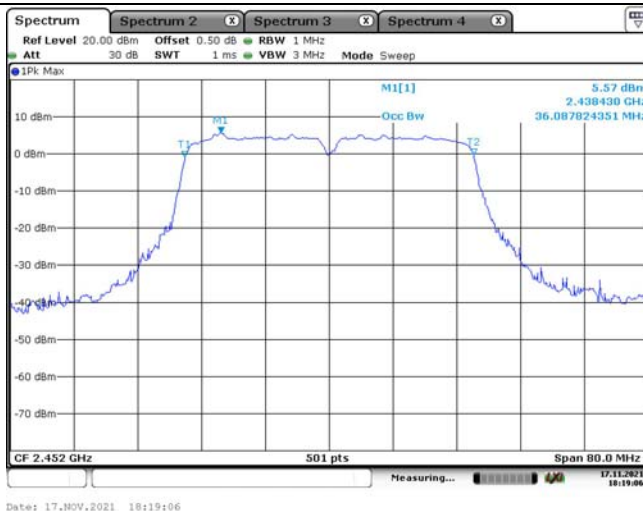

Date: 17.NOV.2021 18:19:06

4.5 Maximum peak conducted output power:

Serial Number:	CR21100068-RF-S1	Test Date:	2021.11.17
Test Site:	RF	Test Mode:	Transmitting
Tester:	Will wei	Test Result:	Pass

Environmental Conditions:

Temperature: (°C)	24.9	Relative Humidity: (%)	59	ATM Pressure: (kPa)	101
----------------------	------	------------------------------	----	------------------------	-----

Test Equipment List and Details:

Manufacturer	Description	Model	Serial Number	Calibration Date	Calibration Due Date
eastsheep	Coaxial Attenuator	2W-SMA-JK-18G	21060301	Each time	N/A
Agilent	USB Wideband Power Sensor	U2021XA	MY54080015	2021-07-22	2022-07-21
zhuoxiang	Coaxial Cable	SMA-178	211001	Each time	N/A

* Statement of Traceability: China Certification ICT Co., Ltd (Dongguan) attests that all calibrations have been performed, traceable to National Primary Standards and International System of Units (SI).

Test Data:

Test Modes	Test Channel	Test Frequency (MHz)	Maximum Conducted Peak Output Power (dBm)	Maximum Conducted Average Output Power (dBm)	Limit (dBm)
802.11b	Lowest	2412	19.35	16.48	30
	Middle	2437	19.27	16.78	30
	Highest	2462	18.51	16.53	30
802.11g	Lowest	2412	23.81	15.68	30
	Middle	2437	22.78	15.89	30
	Highest	2462	20.05	15.77	30
802.11n ht20	Lowest	2412	23.01	15.85	30
	Middle	2437	22.85	16.15	30
	Highest	2462	23.32	16.13	30
802.11n ht40	Lowest	2422	23.25	14.77	30
	Middle	2437	24.02	15.19	30
	Highest	2452	23.01	14.83	30
Antenna Gain:	-1.8	dBi	Max.EIRP:	22.22	dBm
EIRP Limit for RSS-247:36 dBm					

4.6 Maximum power spectral density:

Serial Number:	CR21100068-RF-S1	Test Date:	2021.11.17
Test Site:	RF	Test Mode:	Transmitting
Tester:	Will wei	Test Result:	Pass

Environmental Conditions:

Temperature: (°C)	24.9	Relative Humidity: (%)	59	ATM Pressure: (kPa)	101
----------------------	------	---------------------------	----	------------------------	-----

Test Equipment List and Details:

Manufacturer	Description	Model	Serial Number	Calibration Date	Calibration Due Date
R&S	Spectrum Analyzer	FSV40	101474	2021/7/22	2022/7/21
zhuoxiang	Coaxial Cable	SMA-178	211001	Each time	N/A
Mini-Circuits	DC Block	BLK-18-S+	1554403	Each time	N/A

* Statement of Traceability: China Certification ICT Co., Ltd (Dongguan) attests that all calibrations have been performed, traceable to National Primary Standards and International System of Units (SI).

Test Data:

Test Channel	Test Frequency (MHz)	Power Spectral Density (dBm/3kHz)	Limit (dBm/3kHz)
802.11b	2412	-1.31	8.00
	2437	-1.73	8.00
	2462	-0.97	8.00
802.11g	2412	-14.29	8.00
	2437	-14.27	8.00
	2462	-14.25	8.00
802.11n ht20	2412	-14.99	8.00
	2437	-14.62	8.00
	2462	-14.76	8.00
802.11n ht40	2422	-17.49	8.00
	2437	-18.08	8.00
	2452	-17.35	8.00

Maximum power spectral density

<p>802.11b Lowest Channel</p>	
<p>802.11b Middle Channel</p>	
<p>802.11b Highest Channel</p>	

Maximum power spectral density

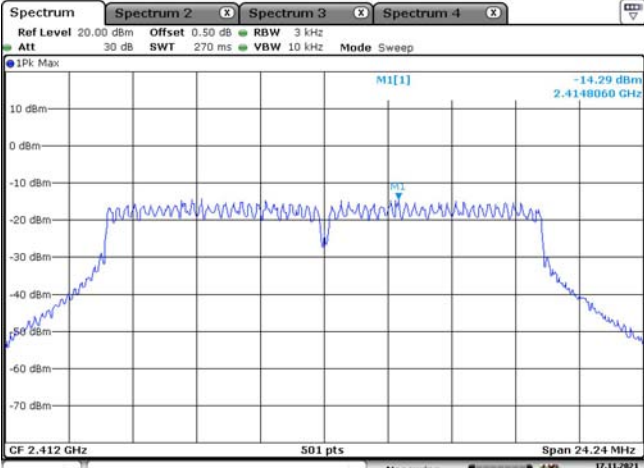
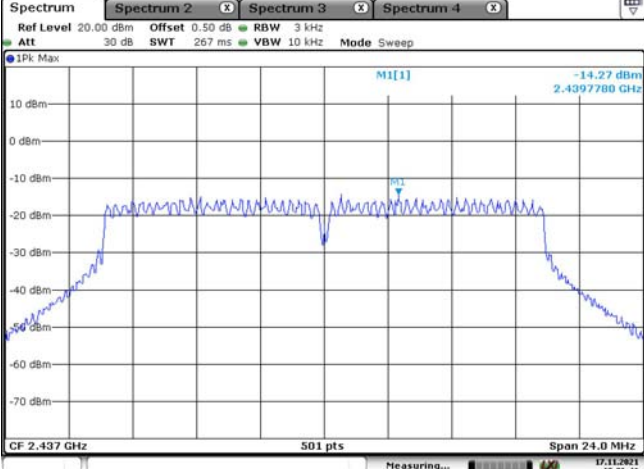
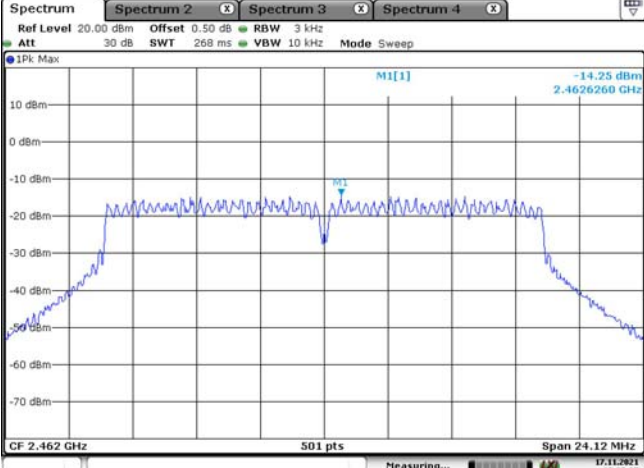
<p>802.11g Lowest Channel</p>	 <p>The spectrum plot shows a signal centered at 2.412 GHz. The y-axis represents power spectral density in dBm, ranging from -70 to 10. The x-axis represents frequency in MHz, with a span of 24.24 MHz. A peak is observed at 2.41480660 GHz with a power level of -14.29 dBm. The plot includes parameters: Ref Level 20.00 dBm, Offset 0.50 dB, RBW 3 kHz, Att 30 dB, SWT 270 ms, VBW 10 kHz, and Mode Sweep. The date and time are 17.NOV.2021 18:05:13.</p>
<p>802.11g Middle Channel</p>	 <p>The spectrum plot shows a signal centered at 2.437 GHz. The y-axis represents power spectral density in dBm, ranging from -70 to 10. The x-axis represents frequency in MHz, with a span of 24.0 MHz. A peak is observed at 2.4397780 GHz with a power level of -14.27 dBm. The plot includes parameters: Ref Level 20.00 dBm, Offset 0.50 dB, RBW 3 kHz, Att 30 dB, SWT 267 ms, VBW 10 kHz, and Mode Sweep. The date and time are 17.NOV.2021 18:06:42.</p>
<p>802.11g Highest Channel</p>	 <p>The spectrum plot shows a signal centered at 2.462 GHz. The y-axis represents power spectral density in dBm, ranging from -70 to 10. The x-axis represents frequency in MHz, with a span of 24.12 MHz. A peak is observed at 2.4626260 GHz with a power level of -14.25 dBm. The plot includes parameters: Ref Level 20.00 dBm, Offset 0.50 dB, RBW 3 kHz, Att 30 dB, SWT 268 ms, VBW 10 kHz, and Mode Sweep. The date and time are 17.NOV.2021 18:09:07.</p>

Maximum power spectral density

802.11n ht20
Lowest Channel

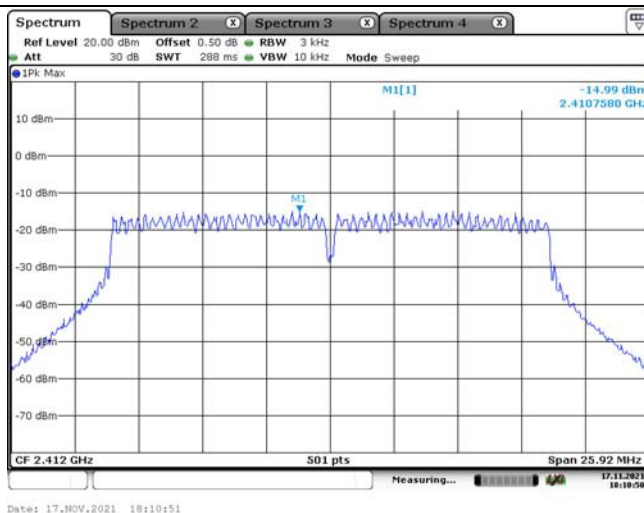

802.11n ht20
Middle Channel

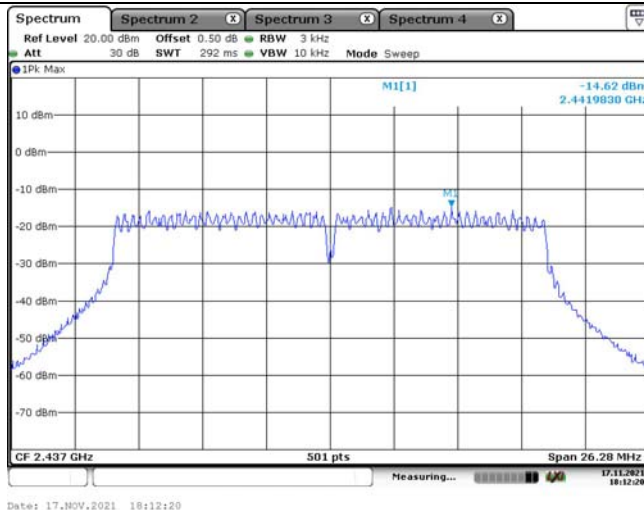

802.11n ht20
Highest Channel

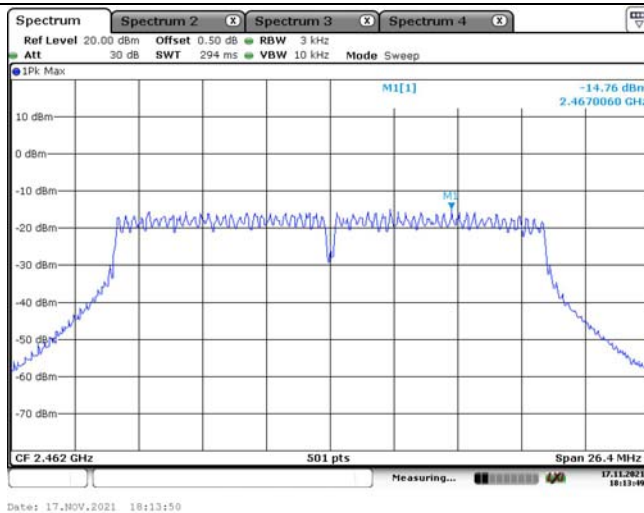

Maximum power spectral density

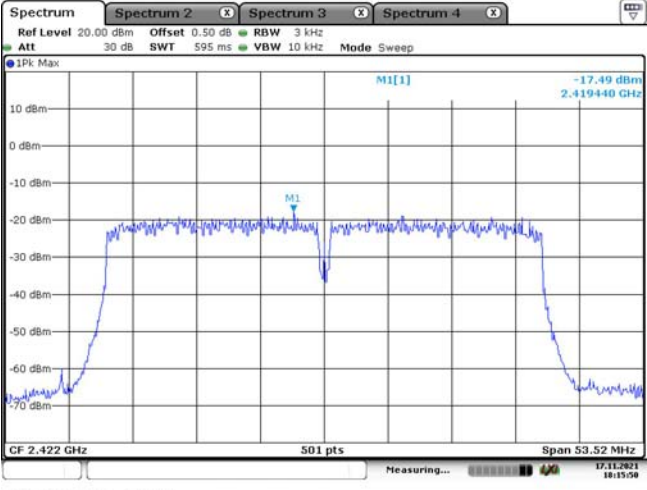
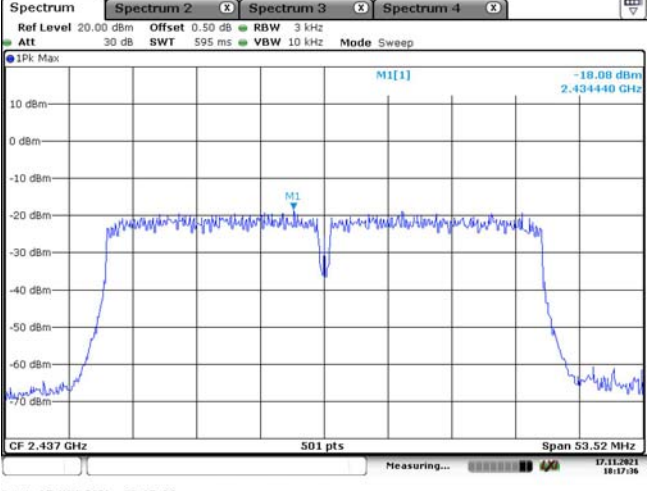
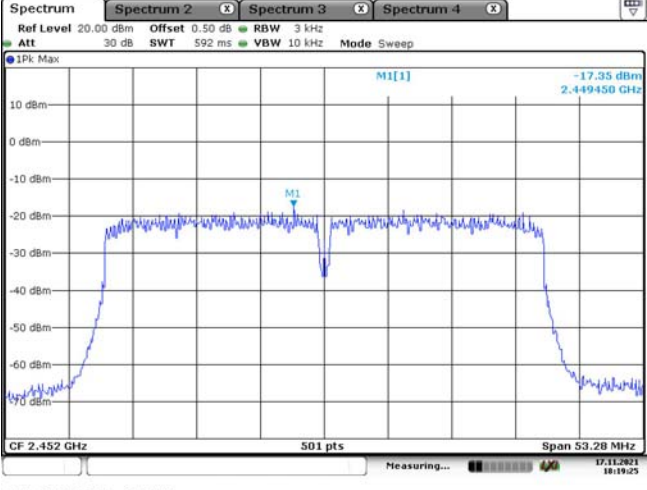
<p>802.11n ht40 Lowest Channel</p>	 <p>Spectrum 2 Spectrum 3 Spectrum 4</p> <p>Ref Level 20.00 dBm Offset 0.50 dB RBW 3 kHz ATT 30 dB SWT 595 ms VBW 10 kHz Mode Sweep</p> <p>1Pk Max M1[1] -17.49 dBm 2.419440 GHz</p> <p>CF 2.422 GHz 501 pts Span 53.52 MHz</p> <p>Date: 17.NOV.2021 18:15:50</p>
<p>802.11n ht40 Middle Channel</p>	 <p>Spectrum 2 Spectrum 3 Spectrum 4</p> <p>Ref Level 20.00 dBm Offset 0.50 dB RBW 3 kHz ATT 30 dB SWT 595 ms VBW 10 kHz Mode Sweep</p> <p>1Pk Max M1[1] -18.08 dBm 2.434440 GHz</p> <p>CF 2.437 GHz 501 pts Span 53.52 MHz</p> <p>Date: 17.NOV.2021 18:17:36</p>
<p>802.11n ht40 Highest Channel</p>	 <p>Spectrum 2 Spectrum 3 Spectrum 4</p> <p>Ref Level 20.00 dBm Offset 0.50 dB RBW 3 kHz ATT 30 dB SWT 592 ms VBW 10 kHz Mode Sweep</p> <p>1Pk Max M1[1] -17.35 dBm 2.449450 GHz</p> <p>CF 2.452 GHz 501 pts Span 53.29 MHz</p> <p>Date: 17.NOV.2021 18:19:25</p>

4.7 100 kHz Bandwidth of Frequency Band Edge:

Serial Number:	CR21100068-RF-S1	Test Date:	2021.11.17
Test Site:	RF	Test Mode:	Transmitting
Tester:	Will wei	Test Result:	Pass

Environmental Conditions:

Temperature: (°C)	24.9	Relative Humidity: (%)	59	ATM Pressure: (kPa)	101
----------------------	------	------------------------------	----	------------------------	-----

Test Equipment List and Details:

Manufacturer	Description	Model	Serial Number	Calibration Date	Calibration Due Date
R&S	Spectrum Analyzer	FSV40	101474	2021/7/22	2022/7/21
zhuoxiang	Coaxial Cable	SMA-178	211001	Each time	N/A
Mini-Circuits	DC Block	BLK-18-S+	1554403	Each time	N/A

* Statement of Traceability: China Certification ICT Co., Ltd (Dongguan) attests that all calibrations have been performed, traceable to National Primary Standards and International System of Units (SI).

Test Data:

100 kHz Bandwidth of Frequency Band Edge

802.11b
Lowest Band edge

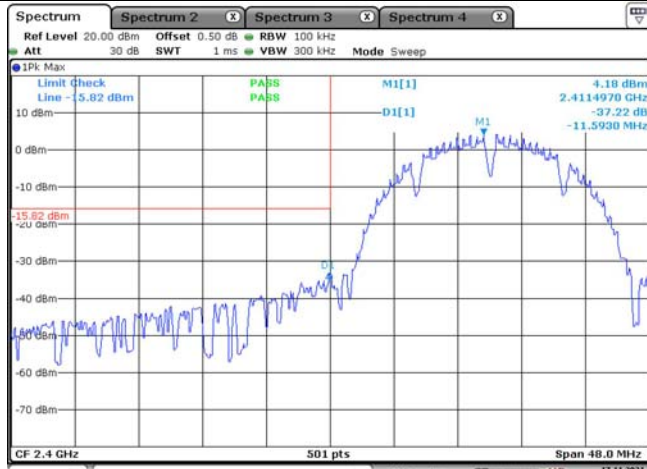

802.11b
Highest Band edge

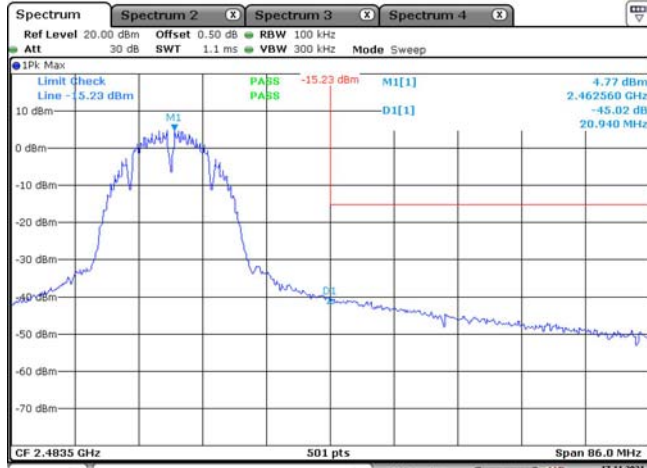

100 kHz Bandwidth of Frequency Band Edge

802.11g
Lowest Band edge

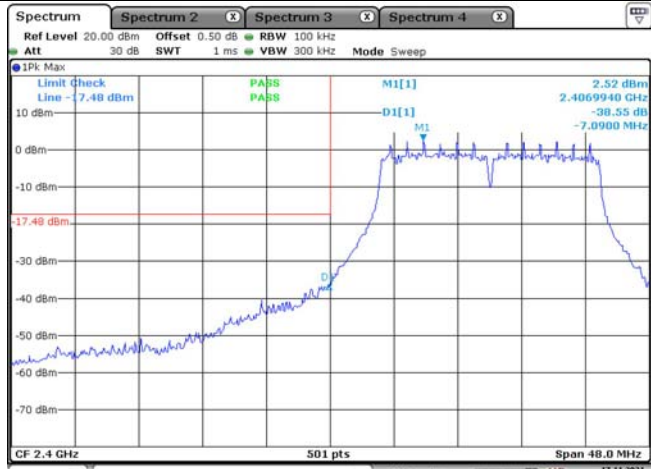

Date: 17.NOV.2021 18:05:39

802.11g
Highest Band edge

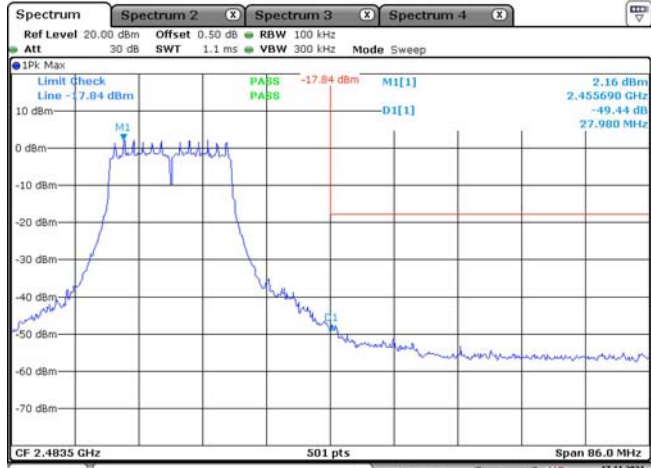

Date: 17.NOV.2021 18:09:24

100 kHz Bandwidth of Frequency Band Edge

802.11n ht20
Lowest Band edge

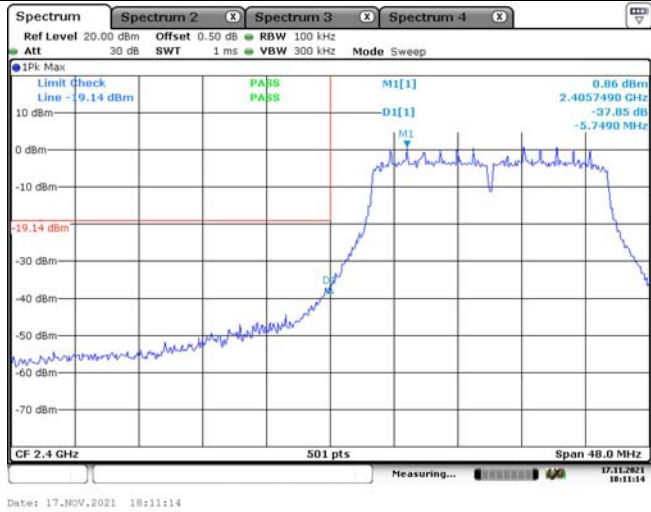

802.11n ht20
Highest Band edge

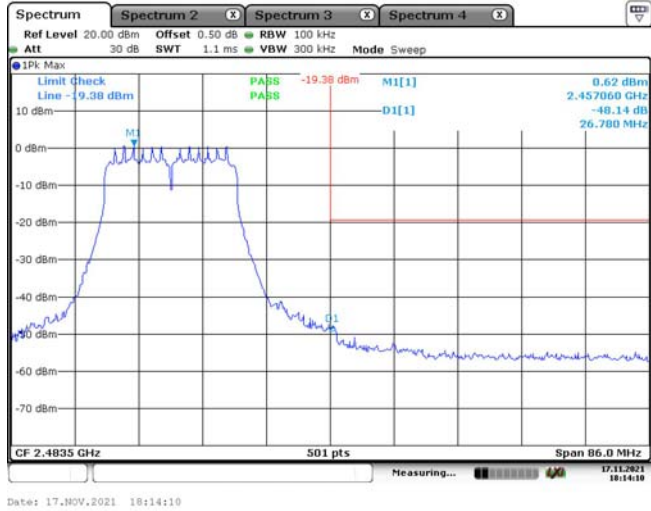

100 kHz Bandwidth of Frequency Band Edge

802.11n ht40
Lowest Band edge

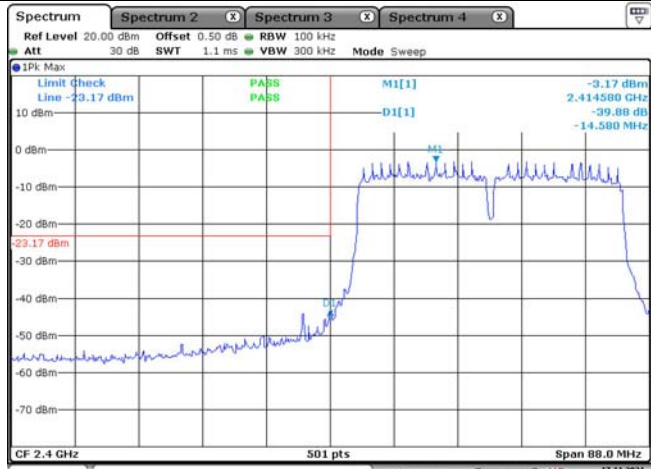

Date: 17.NOV.2021 18:16:20

802.11n ht40
Highest Band edge

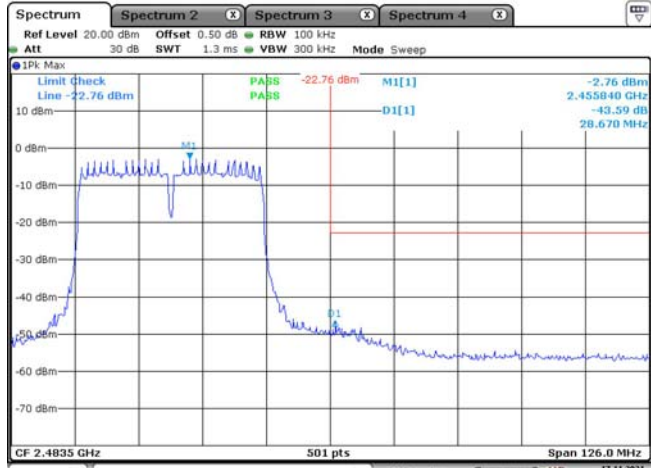

Date: 17.NOV.2021 18:19:52

4.8 Duty Cycle:

Serial Number:	CR21100068-RF-S1	Test Date:	2021.11.17
Test Site:	RF	Test Mode:	Transmitting
Tester:	Will wei	Test Result:	N/A

Environmental Conditions:

Temperature: (°C)	24.9	Relative Humidity: (%)	59	ATM Pressure: (kPa)	101
----------------------	------	------------------------------	----	------------------------	-----

Test Equipment List and Details:

Manufacturer	Description	Model	Serial Number	Calibration Date	Calibration Due Date
R&S	Spectrum Analyzer	FSV40	101474	2021/7/22	2022/7/21
zhuoxiang	Coaxial Cable	SMA-178	211001	Each time	N/A
Mini-Circuits	DC Block	BLK-18-S+	1554403	Each time	N/A

* Statement of Traceability: China Certification ICT Co., Ltd (Dongguan) attests that all calibrations have been performed, traceable to National Primary Standards and International System of Units (SI).

Test Data:

Test Modes	Ton (ms)	Ton+off (ms)	Duty cycle (%)
802.11b	100	100	100.00
802.11g	1.416	1.5	94.40
802.11n ht20	1.332	1.452	91.74
802.11n ht40	0.663	0.71	93.38

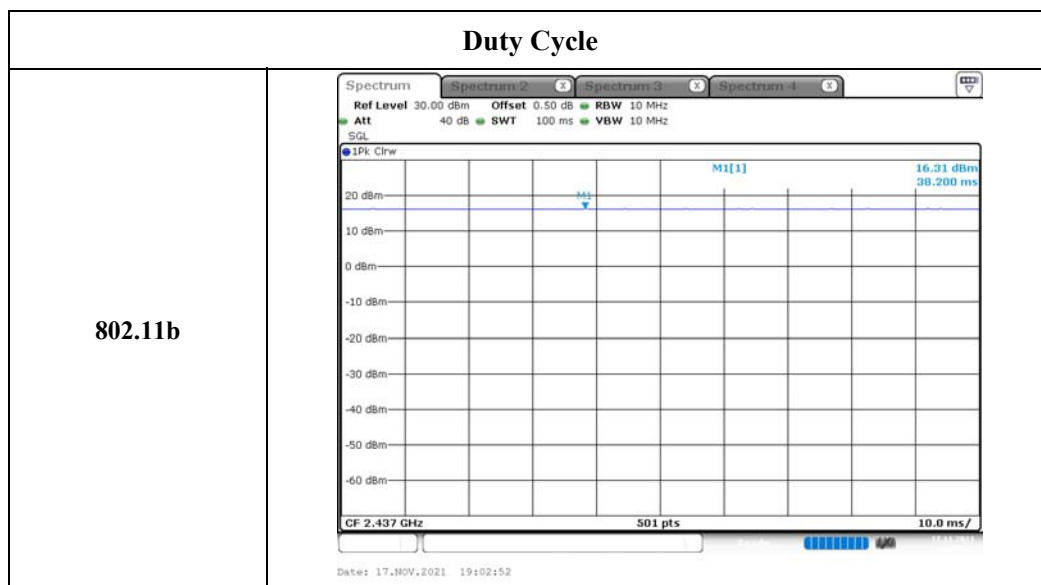

Duty Cycle

802.11g

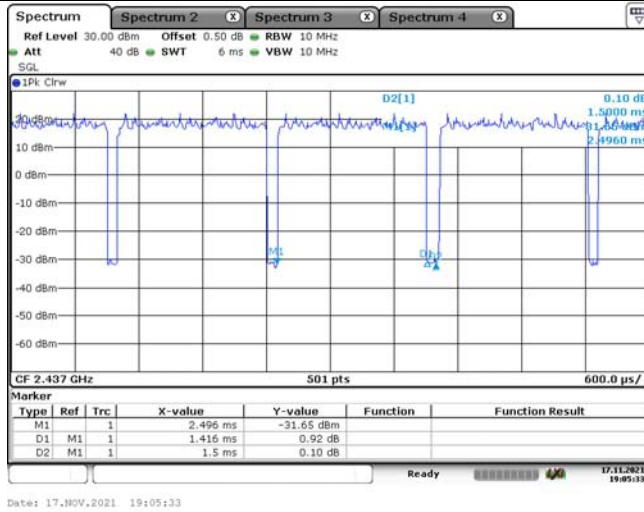

Date: 17.NOV.2021 19:05:33

802.11n ht20

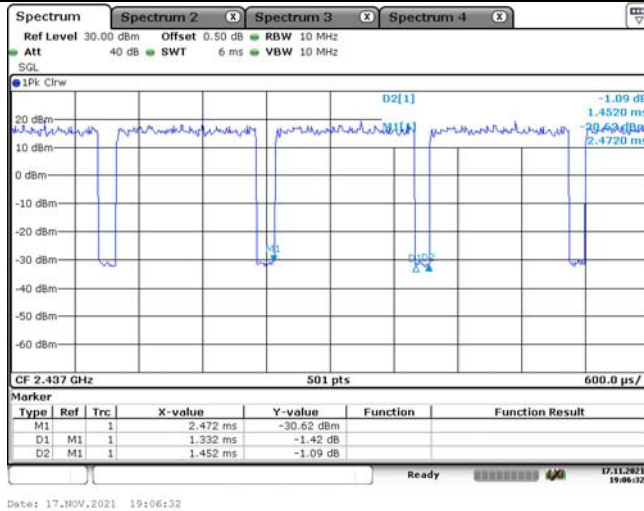

Date: 17.NOV.2021 19:06:32

802.11n ht40

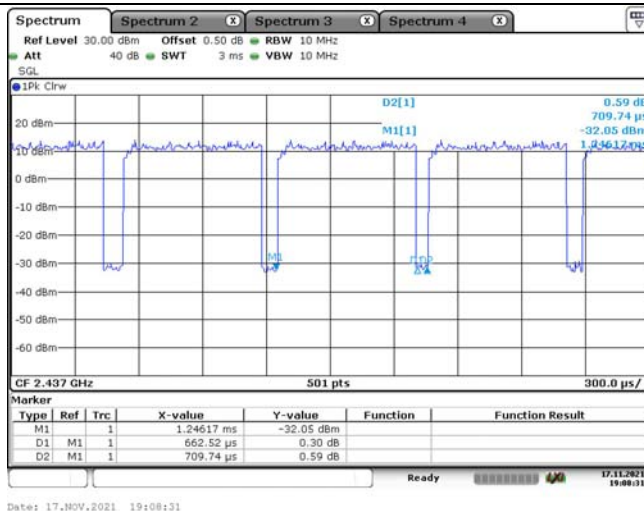

Date: 17.NOV.2021 19:08:31

5. RF EXPOSURE EVALUATION

5.1 MAXIMUM PERMISSIBLE EXPOSURE (MPE)

5.1.1 Applicable Standard

FCC §15.247 (i) & §1.1310 & §2.1091

Systems operating under the provisions of this section shall be operated in a manner that ensures that the public is not exposed to radio frequency energy levels in excess of the Commission's guidelines. See §1.1307(b)(1) of this chapter.

Limits for Maximum Permissible Exposure (MPE) (§1.1310, §2.1091)

(B) Limits for General Population/Uncontrolled Exposure				
Frequency Range (MHz)	Electric Field Strength (V/m)	Magnetic Field Strength (A/m)	Power Density (mW/cm ²)	Averaging Time (minutes)
0.3–1.34	614	1.63	*(100)	30
1.34–30	824/f	2.19/f	*(180/f ²)	30
30–300	27.5	0.073	0.2	30
300–1500	/	/	f/1500	30
1500–100,000	/	/	1.0	30

f = frequency in MHz; * = Plane-wave equivalent power density;

According to §1.1310 and §2.1091 RF exposure is calculated.

5.1.2 Procedure

Prediction of power density at the distance of the applicable MPE limit

$S = PG/4\pi R^2$ = power density (in appropriate units, e.g. mW/cm²);

P = power input to the antenna (in appropriate units, e.g., mW);

G = power gain of the antenna in the direction of interest relative to an isotropic radiator, the power gain factor, is normally numeric gain;

R = distance to the center of radiation of the antenna (appropriate units, e.g., cm);

5.1.3 Calculated Result

Frequency (MHz)	Antenna Gain		Conducted output power including Tune-up Tolerance		Evaluation Distance (cm)	Power Density (mW/cm ²)	MPE Limit (mW/cm ²)
	(dBi)	(numeric)	(dBm)	(mW)			
2412-2462	-1.8	0.66	25	316.23	20.00	0.0416	1.0

Result: The device meet FCC MPE at 20 cm distance

5.2 EXEMPTION LIMITS FOR ROUTINE EVALUATION – RF EXPOSURE EVALUATION

5.2.1 Applicable Standard

RSS-102 § (2.5.2):

RF exposure evaluation is required if the separation distance between the user and/or bystander and the device's radiating element is greater than 20 cm, except when the device operates as follows:

- below 20 MHz and the source-based, time-averaged maximum e.i.r.p. of the device is equal to or less than 1 W (adjusted for tune-up tolerance);
- at or above 20 MHz and below 48 MHz and the source-based, time-averaged maximum e.i.r.p. of the device is equal to or less than $4.49/f^{0.5}$ W (adjusted for tune-up tolerance), where f is in MHz;
- at or above 48 MHz and below 300 MHz and the source-based, time-averaged maximum e.i.r.p. of the device is equal to or less than 0.6 W (adjusted for tune-up tolerance);
- at or above 300 MHz and below 6 GHz and the source-based, time-averaged maximum e.i.r.p. of the device is equal to or less than $1.31 \times 10^{-2} f^{0.6834}$ W (adjusted for tune-up tolerance), where f is in MHz;
- at or above 6 GHz and the source-based, time-averaged maximum e.i.r.p. of the device is equal to or less than 5 W (adjusted for tune-up tolerance).

In these cases, the information contained in the RF exposure technical brief may be limited to information that demonstrates how the e.i.r.p. was derived.

5.2.2 Calculated Result

Mode	Frequency (MHz)	Antenna Gain	Conducted output power including Tune-up Tolerance	EIRP		Exemption limits (mW)	Exemption
		(dBi)	(dBm)	(dBm)	(mW)		
WLAN 2.4GHz	2412-2462	-1.8	25	23.2	209	2684	Yes

Result: Compliance. The device is compliance exemption from Routine Evaluation Limits –RF exposure Evaluation.

***** END OF REPORT *****