

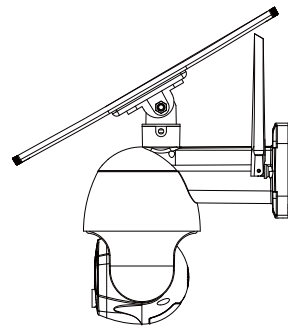

WIFI

APP Quick Start Guide

Solar PTZ Camera Q6



Please read the instructions carefully before using the product and keep it properly. As the APP version is updated, there will be changes. This manual is for reference.

1

1. Packing list (please refer to the actual product)

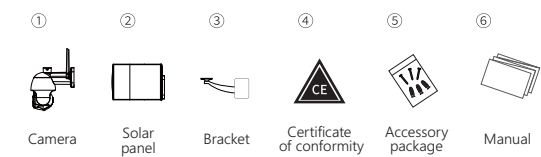

2. Schematic diagram of interface description

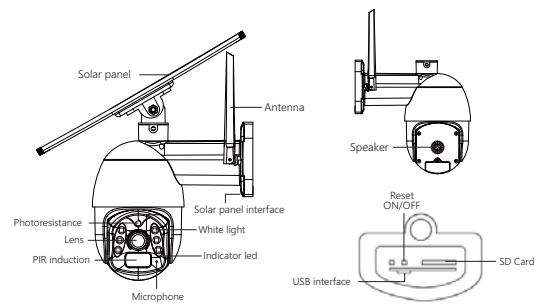

3. Download and install the APP

① Scan the QR code below and click to install or open the mobile app market to search for Tuya Smart.



2

4. Sign up for Login Account

① Enter your mobile phone number or email address. ② Enter the verification code and set the password, then click login.

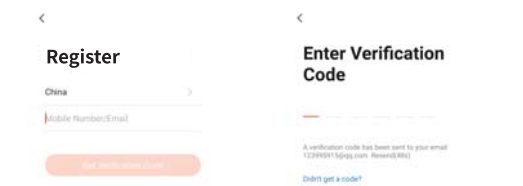

5. Device connection

Note: This device has built-in battery pack. For the first use, please use the DC 5V2A with USB cable to charge for 10 hours.

1. Button: Reset button and On/Off button: ① In the off state, long press for 4 seconds to power up. ② In the boot state, long press for 5 seconds to reset. ③ In the boot state, long press for 10 seconds to power off.

2. Indicator light:
The red light keeps flashing: Wait to connect to the network.
The red lights always on: In error state, please restart.
The red light keeps flashing: The Network connection is in progress.
The blue lights always on: The device is successfully connected.

If recording is needed, please insert the SD card (the chip of SD card is facing the USB interface) then wait for a beep and the red light flashing.

3

3. Please open the APP as follows:

① Click on "+".

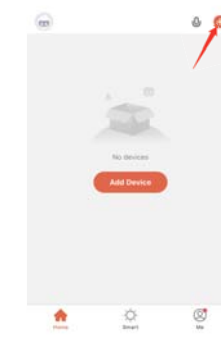

③ Scan the QR code on the device.



② Click "Scan Code".

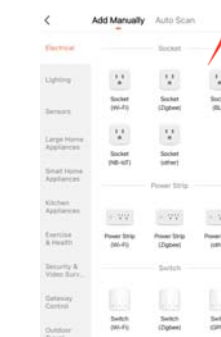

④ Click on "Add".

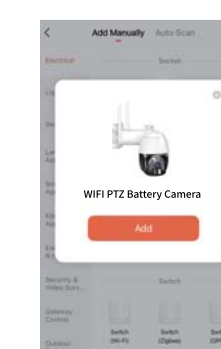

4

⑤ Click on "Next".



⑦ Click on "Next".

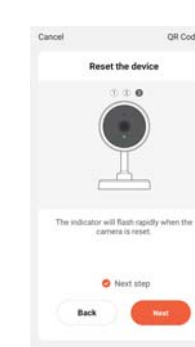

⑥ Make sure the device's indicator led flashes and you hear the beep, then click "Next". (If not, the device is in an error state. Please press the reset button for 5 seconds. At this time, the indicator led flashes and gives a prompt sound, indicating that the device is reconfigured.)

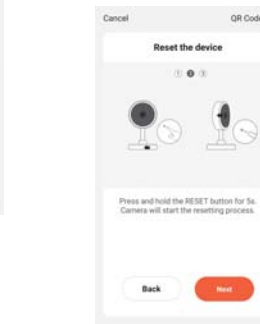

⑧ Enter WiFi account & password, then click "Next".



5

⑨ Aim the phone's QR code at the device and keep a distance of 15-20cm. APP will auto-complete the device configuration and issue a prompt sound after identifying the QR code. Then click "I Heard a Prompt".



⑩ Congratulations! The device is connected.

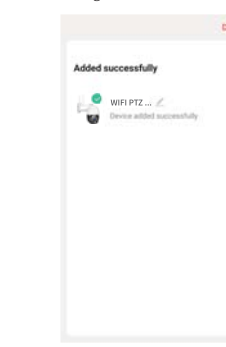

6

⑩ The device is being added.

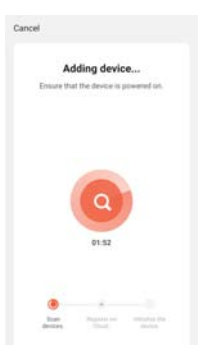

4.Switching and connection of the AP mode.

- ① Open the APP monitoring screen and click the 3 dots in the upper right corner.
- ② Find and click "AP Mode".

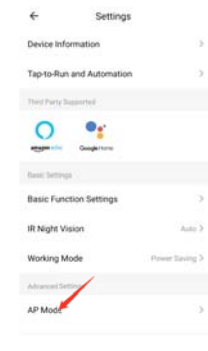

- ③ Set a password with at least 8 digits, then click "Start AP Mode".



- ④ The AP mode is enabled successfully, then click "connect".

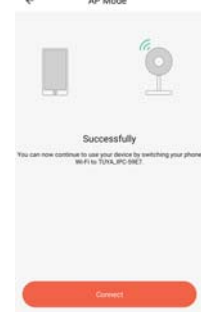

- ⑤ Find the WiFi name "Tuya-IPC", click it to enter the password you just set, and click Connect.

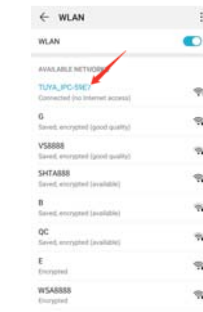

- ⑥ After successful connection, it shows that the current WiFi is unavailable. Do you want to continue using this WiFi? Click Use.



- ⑦ Click back to the APP to see the live screen.
- ⑧ If you need to exit AP mode, shut down the device and restart it.

5. A few reminders about the PIR humanoid detection feature.

- * The humanoid detection sensitivity can be set in the device setting. When used in a crowded environment, it is recommended to turn off or set the device to low sensitivity to avoid unnecessary wake-up to prolong the battery service time.
- * Off : In this state, the device will not perform humanoid detection.
- * Low : When the device is in hibernation state, it can sense movement detection within 5 meters and trigger to report.
- * Middle : When the device is in hibernation state, it can sense movement detection within 7 meters and trigger to report.
- * High : When the device is in hibernation state, it can sense movement detection within 10 meters and trigger to report.

6.Equipment instructions

- ① Support binding third-party software Alexa and Google to wake up the device.
- ② View alarm messages. Click on Message Notification to view the device's alarm message.

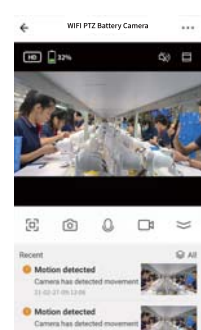
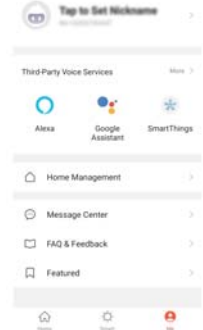

- ③ Check the video playback. Click "Playback" then select the date to view all the files and videos of the day.

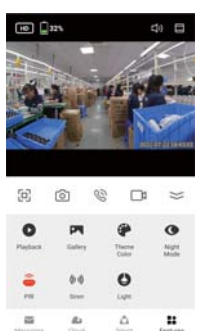

7.Matters needing attention

- ① PIR is sensitive to cold and hot disturbance, points should be noted during installation:
 - * Avoid placing the device in places where the air is churning. For example: air conditioning outlet, equipment cooling outlet, fan surrounding, curtain nearby, etc.
 - * Do not install the device directly in front of the glass or mirror.
 - * The recommended installation height of the device is about 2.5m-3m.
 - * Do not invert the device.
- ② The device supports battery power, and the battery's service time is affected by the wake-up time and frequency of the device. So the human detection function is suggested to turn off or set the device to low sensitivity when used in a crowded environment, so as to reduce the wake-up times of the device and extend the application time. When the device is low in power, please charge it in time. If the battery is underpowered for a long time, it may cause battery failure.
- ③ During the installation of the device, please ensure that the WIFI network signal is stable at the installation location, especially outdoors. Please check whether the WIFI is covered. If the WIFI signal is weak, a WIFI router should be added to improve the signal.
- ④ The device is a low-power intelligent product, which can support APP remote wake up, PIR human detection wake up, button wake up. Each time the wake-up device works, it will automatically enter the sleep state after a short time.
- ⑤ To ensure that the device can work normally, please first use the original DC 5V2A charger with USB cable to charge for 10 hours. Do not use a mobile power supply to charge, otherwise it is very likely to cause a short circuit.
- ⑥ The device supports WiFi 2.4GHz but does not support WiFi 5GHz.

8.Troubleshooting

- ① Network allocation failed:
 - * Check if the camera is in the configuration state.
 - * Please make sure that the phone, camera and router are close enough.
 - * Note that this camera does not support 5GHz routers.
 - * Check whether the router name and password are correct.
- ② The device is offline:
 - * Check the internet connection of the router.
 - * Check the connection between the router and the camera. If you change the router or modify the WIFI password, you need to reset the camera and reconfigure the network.
 - * Check if the camera battery is exhausted, you can try to plug in the USB power source and try again.
- ③ Unable to preview:
 - * The server may be congested, you can try to restart the APP and try again.
- ④ No news push:
 - * Please make sure that the APP has notification permissions.
 - * Please make sure to turn on the alert message button in the APP personal center settings.
 - * Please make sure the PIR switch in the camera settings is turned on.
- ⑤ No video files:
 - * Please insert the SD card before powering on.
 - * Please make sure that the PIR switch of the camera is turned on.
 - * Please make sure that the camera recording switch is turned on.
 - * Please check whether the SD card status in the APP device is normal, if it is abnormal, please try to format the SD card.

9.Common Problems

- Q: Why does the battery drain so fast?
- A: Frequent triggering of the human detection function in a crowded environment can cause the device to work for a long time and consume power easily. Please try to lower the PIR sensitivity setting; Long time to view video playback file, easy to consume power; Check whether the device signal is stable. If the network is not normal, the device may wake up multiple times and consume power easily. Please try to change the position of the device or change the SIM operator.
- Q: How can I confirm that the camera is connected properly?
- A: Please try to actively trigger PIR, wait for 3 seconds, the blue light is on, indicating that the device is connected properly.

FCC Caution.

This device complies with part 15 of the FCC Rules. Operation is subject to the following two conditions:

- (1) This device may not cause harmful interference, and
- (2) this device must accept any interference received, including interference that may cause undesired operation.

Any Changes or modifications not expressly approved by the party responsible for compliance could void the user's authority to operate the equipment.

Note: This equipment has been tested and found to comply with the limits for a Class B digital device, pursuant to part 15 of the FCC Rules. These limits are designed to provide reasonable protection against harmful interference in a residential installation. This equipment generates uses and can radiate radio frequency energy and, if not installed and used in accordance with the instructions, may cause harmful interference to radio communications. However, there is no guarantee that interference will not occur in a particular installation. If this equipment does cause harmful interference to radio or television reception, which can be determined by turning the equipment off and on, the user is encouraged to try to correct the interference by one or more of the following measures:

- Reorient or relocate the receiving antenna.
- Increase the separation between the equipment and receiver.
- Connect the equipment into an outlet on a circuit different from that to which the receiver is connected.
- Consult the dealer or an experienced radio/TV technician for help.

The antenna of this product, under normal use condition, is at least 20cm away from the body of the user. Warning statement to the user for keeping at least 20cm or more separation distance from the antenna should be included in the User manual. So, this device is classified as Mobile device.